

***Nikon***

DIGITAL CAMERA

# COOLPIX L830

Reference Manual

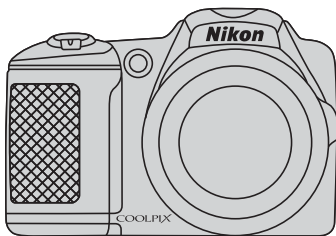

En



<b>Introduction</b>	
<b>Parts of the Camera</b>	
<b>The Basics of Shooting and Playback</b>	
<b>Shooting Features</b>	
<b>Playback Features</b>	
<b>Recording and Playing Back Movies</b>	
<b>General Camera Setup</b>	
<b>Connecting the Camera to a TV, Computer, or Printer</b>	
<b>Reference Section</b>	
<b>Technical Notes and Index</b>	

# Introduction

## Read This First

Thank you for purchasing the Nikon COOLPIX L830 digital camera. Before using the camera, please read the information in “For Your Safety” (📖 viii-xi) and familiarize yourself with the information provided in this manual. After reading, please keep this manual handy and refer to it to enhance your enjoyment of your new camera.



## About This Manual





If you want to start using the camera right away, see “The Basics of Shooting and Playback” (📖 12).

To learn about the parts of the camera and information that is displayed in the monitor, see “Parts of the Camera” (📖 1).

## Other Information

- Symbols and Conventions

To make it easier to find the information you need, the following symbols and conventions are used in this manual:

Icon	Description
	This icon indicates cautions and information that should be read before using the camera.
	This icon indicates notes and information that should be read before using the camera.
	These icons indicate other pages containing relevant information;  : "Reference Section",  : "Technical Notes and Index."

- SD, SDHC, and SDXC memory cards are referred to as "memory cards" in this manual.
- The setting at the time of purchase is referred to as the "default setting."
- The names of menu items displayed in the camera monitor, and the names of buttons or messages displayed on a computer monitor appear in bold.
- In this manual, images are sometimes omitted from monitor display samples so that monitor indicators can be more clearly shown.
- Illustrations and monitor content shown in this manual may differ from the actual product.

# Information and Precautions

## Life-Long Learning

As part of Nikon's "Life-Long Learning" commitment to ongoing product support and education, continually updated information is available online at the following sites:

- For users in the U.S.A.: <http://www.nikonusa.com/>
- For users in Europe and Africa: <http://www.europe-nikon.com/support/>
- For users in Asia, Oceania, and the Middle East: <http://www.nikon-asia.com/>

Visit these sites to keep up-to-date with the latest product information, tips, answers to frequently asked questions (FAQs), and general advice on digital imaging and photography. Additional information may be available from the Nikon representative in your area. Visit the site below for contact information:

<http://imaging.nikon.com/>

## Use Only Nikon Brand Electronic Accessories

Nikon COOLPIX cameras are designed to the highest standards and include complex electronic circuitry. Only Nikon brand electronic accessories (including battery chargers, batteries, and AC adapters) certified by Nikon specifically for use with this Nikon digital camera are engineered and proven to operate within the operational and safety requirements of this electronic circuitry.

THE USE OF NON-NIKON ELECTRONIC ACCESSORIES COULD DAMAGE THE CAMERA AND MAY VOID YOUR NIKON WARRANTY.

For more information about Nikon brand accessories, contact a local authorized Nikon dealer.

## Before Taking Important Pictures

Before taking pictures on important occasions (such as at weddings or before taking the camera on a trip), take a test shot to ensure that the camera is functioning normally. Nikon will not be held liable for damages or lost profits that may result from product malfunction.

## About the Manuals

- No part of the manuals included with this product may be reproduced, transmitted, transcribed, stored in a retrieval system, or translated into any language in any form, by any means, without Nikon's prior written permission.
- Nikon reserves the right to change the specifications of the hardware and software described in these manuals at any time and without prior notice.
- Nikon will not be held liable for any damages resulting from the use of this product.
- While every effort was made to ensure that the information in these manuals is accurate and complete, we would appreciate it were you to bring any errors or omissions to the attention of the Nikon representative in your area (address provided separately).

## Notice Concerning Prohibition of Copying or Reproduction

Note that simply being in possession of material that was digitally copied or reproduced by means of a scanner, digital camera or other device may be punishable by law.

### • **Items prohibited by law from being copied or reproduced**

Do not copy or reproduce paper money, coins, securities, government bonds or local government bonds, even if such copies or reproductions are stamped "Sample." The copying or reproduction of paper money, coins, or securities which are circulated in a foreign country is prohibited. Unless the prior permission of the government was obtained, the copying or reproduction of unused postage stamps or post cards issued by the government is prohibited.

The copying or reproduction of stamps issued by the government and of certified documents stipulated by law is prohibited.

### • **Cautions on certain copies and reproductions**

The government has issued cautions on copies or reproductions of securities issued by private companies (shares, bills, checks, gift certificates, etc.), commuter passes, or coupon tickets, except when a minimum of necessary copies are to be provided for business use by a company. Also, do not copy or reproduce passports issued by the government, licenses issued by public agencies and private groups, ID cards and tickets, such as passes and meal coupons.

### • **Comply with copyright notices**

The copying or reproduction of copyrighted creative works such as books, music, paintings, woodcut prints, maps, drawings, movies, and photographs is governed by national and international copyright laws. Do not use this product for the purpose of making illegal copies or to infringe copyright laws.

## Disposing of Data Storage Devices

Please note that deleting images or formatting data storage devices such as memory cards or built-in camera memory does not completely erase the original image data. Deleted files can sometimes be recovered from discarded storage devices using commercially available software, potentially resulting in the malicious use of personal image data. Ensuring the privacy of such data is the user's responsibility.

Before discarding a data storage device or transferring ownership to another person, erase all data using commercial deletion software, or format the device and then completely refill it with images containing no private information (for example, pictures of empty sky). Be sure to also replace any pictures selected for the **Select an image** option in the **Welcome screen** setting (📖 72). Care should be taken to avoid injury or damage to property when physically destroying data storage devices.

## For Your Safety

To prevent damage to your Nikon product or injury to yourself or to others, read the following safety precautions in their entirety before using this equipment. Keep these safety instructions where all those who use the product will read them.



This icon marks warnings, information that should be read before using this Nikon product, to prevent possible injury.

### WARNINGS

#### **Turn off in the event of malfunction**

Should you notice smoke or an unusual smell coming from the camera or AC adapter, unplug the AC adapter and remove the batteries immediately, taking care to avoid burns. Continued operation could result in injury. After removing or disconnecting the power source, take the equipment to a Nikon-authorized service representative for inspection.

#### **Do not disassemble**

Touching the internal parts of the camera or AC adapter could result in injury. Repairs should be performed only by qualified technicians. Should

the camera or AC adapter break open as the result of a fall or other accident, take the product to a Nikon-authorized service representative for inspection, after unplugging the product and/or removing the batteries.

#### **Do not use the camera or AC adapter in the presence of flammable gas**

Do not use electronic equipment in the presence of flammable gas, as this could result in explosion or fire.

#### **Handle the camera strap with care**

Never place the strap around the neck of an infant or child.

** Keep out of reach of children**

Particular care should be taken to prevent infants from putting the batteries or other small parts into their mouths.

** Do not remain in contact with the camera, battery charger, or AC adapter for extended periods while the devices are on or in use**

Parts of the devices become hot. Leaving the devices in direct contact with the skin for extended periods may result in low-temperature burns.

** Do not leave the product where it will be exposed to extremely high temperatures, such as in an enclosed automobile or in direct sunlight**

Failure to observe this precaution could cause damage or fire.

** Observe caution when handling batteries**

Batteries may leak or explode if improperly handled. Observe the following precautions when handling batteries for use in this product:

- Before replacing the batteries, turn the product off. If you are using an AC adapter, be sure it is unplugged.
- Use only the batteries approved for use in this product (📖 13). Do not combine old and new batteries or batteries of different makes or types.
- When charging Nikon EN-MH2 rechargeable Ni-MH batteries, use only the specified charger and charge the batteries four at a time. When replacing the batteries with EN-MH2-B2 batteries (available separately), purchase two sets (total of four batteries).
- The EN-MH2 rechargeable batteries are for use with Nikon digital cameras only, and are compatible with COOLPIX L830.
- Insert batteries in the correct orientation.
- Do not short or disassemble batteries or attempt to remove or break battery insulation or casing.
- Do not expose batteries to flame or to excessive heat.
- Do not immerse in or expose to water.
- Do not transport or store with metal objects such as necklaces or hairpins.

- Batteries are prone to leakage when fully discharged. To avoid damage to the product, be sure to remove the batteries when no charge remains.
- Discontinue use immediately should you notice any change in the batteries, such as discoloration or deformation.
- If liquid from damaged batteries comes in contact with clothing or skin, rinse immediately with plenty of water.

 **Observe the following precautions when handling the Battery Chargers (available separately)**

- Keep dry. Failure to observe this precaution could result in fire or electric shock.
  - Dust on or near the metal parts of the plug should be removed with a dry cloth. Continued use could result in fire.
  - Do not handle the power cable or go near the battery charger during lightning storms. Failure to observe this precaution could result in electric shock.
- Do not damage, modify, forcibly tug or bend the power cable, place it under heavy objects, or expose it to heat or flame. Should the insulation be damaged and the wires become exposed, take it to a Nikon-authorized service representative for inspection. Failure to observe these precautions could result in fire or electric shock.
  - Do not handle the plug or battery charger with wet hands. Failure to observe this precaution could result in electric shock.
  - Do not use with travel converters or adapters designed to convert from one voltage to another or with DC-to-AC inverters. Failure to observe this precaution could damage the product or result in overheating or fire.

 **Use appropriate cables**

When connecting cables to the input and output jacks, use only the cables provided or sold by Nikon for the purpose, to maintain compliance with product regulations.



** Handle moving parts with care**

Be careful that your fingers or other objects are not pinched by the lens cover or other moving parts.

** Observe caution when using the flash**

Using the flash close to your subject's eyes could cause temporary visual impairment. The flash should be no less than 1 m (3 ft 4 in.) from the subject. Particular care should be observed when photographing infants.

** Do not operate the flash with the flash window touching a person or object**

Failure to observe this precaution could result in burns or fire.

** Avoid contact with liquid crystal**

Should the monitor break, care should be taken to avoid injury caused by broken glass and to prevent liquid crystal from the monitor touching the skin or entering the eyes or mouth.

** Turn the power off when using inside an airplane or the hospital**

Turn the power off while inside the airplane during take off or landing.

Do not use wireless network functions while in the air.

Follow the instructions of the hospital when using while in a hospital.

The electromagnetic waves emitted by this camera may disrupt the electronic systems of the airplane or the instruments of the hospital. If you are using an Eye-Fi card, remove it from the camera before boarding an aircraft or entering a hospital.

## Notices

### Notice for Customers in the U.S.A.

#### **Federal Communications Commission (FCC) Radio Frequency Interference Statement**

This equipment has been tested and found to comply with the limits for a Class B digital device, pursuant to Part 15 of the FCC rules. These limits are designed to provide reasonable protection against harmful interference in a residential installation. This equipment generates, uses, and can radiate radio frequency energy and, if not installed and used in accordance with the instructions, may cause harmful interference to radio communications. However, there is no guarantee that interference will not occur in a particular installation. If this equipment does cause harmful interference to radio or television reception, which can be determined by turning the equipment off and on, the user is encouraged to try to correct the interference by one or more of the following measures:

- Reorient or relocate the receiving antenna.
- Increase the separation between the equipment and receiver.
- Connect the equipment into an outlet on a circuit different from that to which the receiver is connected.
- Consult the dealer or an experienced radio/television technician for help.



**Nikon**

COOLPIX L830

### **CAUTIONS**

#### **Modifications**

The FCC requires the user to be notified that any changes or modifications made to this device that are not expressly approved by Nikon Corporation may void the user's authority to operate the equipment.

## Interface Cables

Use the interface cables sold or provided by Nikon for your equipment. Using other interface cables may exceed the limits of Class B Part 15 of the FCC rules.

## Notice for customers in the State of California

### WARNING

Handling the cord on this product will expose you to lead, a chemical known to the State of California to cause birth defects or other reproductive harm.

### ***Wash hands after handling.***

Nikon Inc.,  
1300 Walt Whitman Road Melville,  
New York 11747-3064 USA  
Tel: 631-547-4200

## Notice for customers in Canada

CAN ICES-3 B / NMB-3 B

## Notice for Customers in Europe

This symbol indicates that electrical and electronic equipment is to be collected separately.



The following apply only to users in European countries:

- This product is designated for separate collection at an appropriate collection point. Do not dispose of as household waste.
- Separate collection and recycling helps conserve natural resources and prevent negative consequences for human health and the environment that might result from incorrect disposal.
- For more information, contact the retailer or the local authorities in charge of waste management.

This symbol on the batteries indicates that the batteries are to be collected separately.



The following apply only to users in European countries:

- All batteries, whether marked with this symbol or not, are designated for separate collection at an appropriate collection point. Do not dispose of as household waste.
- For more information, contact the retailer or the local authorities in charge of waste management.

# Table of Contents

<b>Introduction</b> .....	<b>ii</b>	<b>The Basics of Shooting and Playback</b> ...	<b>12</b>
<b>Read This First</b> .....	<b>ii</b>	<b>Preparation 1 Insert the Batteries</b> .....	<b>12</b>
About This Manual .....	iii	Applicable Batteries .....	13
Information and Precautions .....	v	<b>Preparation 2 Insert a Memory Card</b> .....	<b>14</b>
<b>For Your Safety</b> .....	<b>viii</b>	Internal Memory and Memory Cards .....	15
WARNINGS .....	viii	<b>Preparation 3 Setting the Display Language, Date, and Time</b> .....	<b>16</b>
<b>Notices</b> .....	<b>xii</b>	<b>Step 1 Turn the Camera On</b> .....	<b>20</b>
<b>Parts of the Camera</b> .....	<b>1</b>	<b>Step 2 Select a Shooting Mode</b> .....	<b>22</b>
<b>The Camera Body</b> .....	<b>1</b>	Available Shooting Modes .....	23
Changing the Angle of the Monitor .....	3	<b>Step 3 Frame a Picture</b> .....	<b>24</b>
Attaching the Camera Strap and Lens Cap ...	4	Using the Zoom .....	25
Raising and Lowering the Flash .....	5	<b>Step 4 Focus and Shoot</b> .....	<b>26</b>
<b>Using Menus (the MENU Button)</b> .....	<b>6</b>	The Shutter-release Button .....	27
<b>The Monitor</b> .....	<b>8</b>	<b>Step 5 Play Back Images</b> .....	<b>28</b>
Shooting Mode .....	8	<b>Step 6 Delete Images</b> .....	<b>29</b>
Playback Mode .....	10		

Shooting Features.....	31	Playback Features .....	62
📷 (Easy Auto) Mode .....	31	Playback Zoom .....	62
Scene Mode (Shooting Suited to Scenes) ...	32	Thumbnail Playback, Calendar Display.....	63
Tips and Notes .....	33	Functions That Can Be Set with the	
Special Effects Mode		<b>MENU</b> Button (Playback Menu) .....	64
(Applying Effects When Shooting) .....	38		
Smart Portrait Mode		Recording and Playing Back Movies ...	65
(Capturing Images of Smiling Faces).....	40	Recording Movies .....	65
📷 (Auto) Mode .....	42	Functions That Can Be Set with the	
<b>Functions That Can Be Set Using the Multi</b>		<b>MENU</b> Button (Movie Menu).....	69
<b>Selector.....</b>	43	Playing Back Movies.....	70
Using the Flash.....	44		
Using the Self-timer .....	47	General Camera Setup .....	72
Using Macro Mode.....	49	<b>Functions That Can Be Set with the</b>	
Adjusting Brightness		<b>MENU</b> Button (Setup Menu) .....	72
(Exposure Compensation).....	50		
Default Settings.....	51	Connecting the Camera to a TV,	
<b>Functions That Can Be Set with the</b>		Computer, or Printer.....	74
<b>MENU</b> Button (Shooting Menu) .....	53	Connection Methods.....	74
Options Available in the Shooting Menu... 54		Using ViewNX 2 .....	76
<b>Functions That Cannot Be Used</b>		Installing ViewNX 2.....	76
<b>Simultaneously .....</b>	55	Transferring Images to the Computer.....	77
<b>Focusing.....</b>	57	Viewing Images .....	79
Using Face Detection.....	57		
Using Skin Softening.....	58		
Using Target Finding AF .....	59		
Subjects Not Suitable for Autofocus .....	60		
Focus Lock.....	61		

<b>Reference Section</b> .....	1	<b>Editing Movies</b> .....	25
<b>Using Easy Panorama</b>		Extracting Only the Desired Portions of a Movie .....	25
<b>(Shooting and Playback)</b> .....	2	Saving a Frame from a Movie as a Still Image .....	26
Shooting with Easy Panorama .....	2	<b>The Shooting Menu</b>	
Viewing Images Captured with Easy Panorama .....	5	<b>(for  (Auto) Mode)</b> .....	27
<b>Viewing and Deleting Images Captured Continuously (Sequence)</b> .....	6	Image Mode Settings	
Viewing Images in a Sequence .....	6	(Image Size and Quality) .....	27
Deleting Images in a Sequence .....	7	White Balance (Adjusting Hue) .....	29
<b>Editing Still Images</b> .....	8	Continuous Shooting .....	32
Before Editing Images .....	8	ISO Sensitivity .....	34
Quick Retouch:		Color Options .....	35
Enhancing Contrast and Saturation .....	9	AF Area Mode .....	36
D-Lighting:		<b>The Smart Portrait Menu</b> .....	40
Enhancing Brightness and Contrast .....	9	Skin Softening .....	40
Red-eye Correction: Correcting Red Eyes Caused by Using the Flash .....	10	Smile Timer .....	40
Skin Softening: Softening Skin Tones .....	11	Blink Proof .....	41
Filter Effects:		<b>The Playback Menu</b> .....	42
Applying Digital Filter Effects .....	12	Print Order	
Small Picture:		(Creating a DPOF Print Order) .....	42
Reducing the Size of an Image .....	14	Slide Show .....	45
Crop: Creating a Cropped Copy .....	15	Protect .....	46
<b>Connecting the Camera to a TV</b>		Rotate Image .....	48
<b>(Viewing Images on a TV)</b> .....	16	Copy (Copy Between Internal Memory and Memory Card) .....	49
<b>Connecting the Camera to a Printer</b>		Sequence Display Options .....	51
<b>(Direct Print)</b> .....	18	Choose Key Picture .....	51
Connecting the Camera to a Printer .....	19		
Printing Individual Images .....	20		
Printing Multiple Images .....	22		

<b>The Movie Menu</b> .....	52
Movie Options .....	52
AF Area Mode .....	55
Autofocus Mode .....	55
Movie VR .....	56
Wind Noise Reduction .....	56
<b>The Setup Menu</b> .....	57
Welcome Screen .....	57
Time Zone and Date .....	58
Monitor Settings .....	60
Print Date (Imprinting Date and Time) .....	62
Photo VR .....	63
Motion Detection .....	64
AF Assist .....	65
Sound Settings .....	65
Auto Off .....	66
Format Memory/Format Card .....	67
Language .....	68
TV Settings .....	68
Blink Warning .....	69
Eye-Fi Upload .....	70
Reset All .....	71
Battery Type .....	72
Firmware Version .....	72
<b>Error Messages</b> .....	73
<b>File Names</b> .....	77
<b>Optional Accessories</b> .....	78
<b>Technical Notes and Index</b> .....	1
<b>Caring for the Product</b> .....	2
The Camera .....	2
Batteries .....	3
Memory Cards .....	5
<b>Cleaning and Storage</b> .....	6
Cleaning .....	6
Storage .....	6
<b>Troubleshooting</b> .....	7
<b>Specifications</b> .....	14
Approved Memory Cards .....	18
<b>Index</b> .....	21







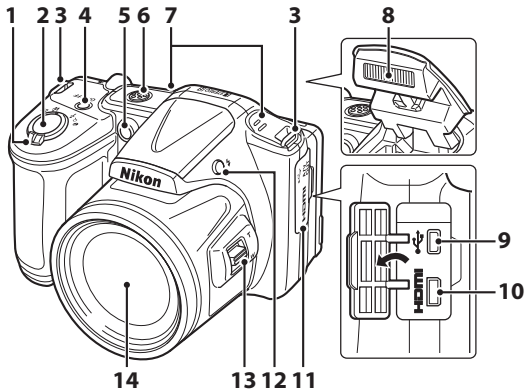

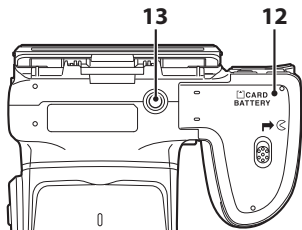
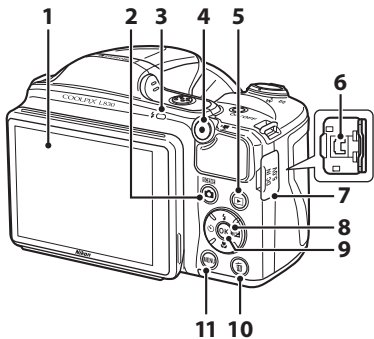

# Parts of the Camera

## The Camera Body



<b>1</b>	Zoom control.....	25	<b>6</b>	Speaker.....	70
	<b>W</b> : wide-angle.....	25	<b>7</b>	Microphone (stereo) .....	65
	<b>T</b> : telephoto.....	25	<b>8</b>	Flash .....	5, 44
	: thumbnail playback.....	63	<b>9</b>	USB/audio/video output connector.....	74
	: playback zoom.....	62	<b>10</b>	HDMI micro connector (Type D).....	74
	: help.....	32	<b>11</b>	Connector cover.....	74
<b>2</b>	Shutter-release button.....	26	<b>12</b>	(flash pop-up) button.....	5, 44
<b>3</b>	Eyelet for camera strap .....	4	<b>13</b>	Side zoom control .....	25
<b>4</b>	Power switch/power-on lamp.....	20	<b>14</b>	Lens	
<b>5</b>	Self-timer lamp.....	47			
	AF-assist illuminator.....	72			



1	Monitor .....	8	8	Multi selector .....	6
2	 (shooting mode) button .....31, 32, 38, 40, 42		9	 (apply selection) button.....6	
3	Flash lamp.....46		10	 (delete) button.....29	
4	 movie-record) button.....65		11	<b>MENU</b> (menu) button ..... 6, 53, 64, 69, 72	
5	 (playback) button.....28		12	Battery-chamber/ memory card slot cover.....12, 14	
6	DC input connector (for AC adapter available separately from Nikon) .....  78		13	Tripod socket.....  17	
7	DC input connector cover				

## Changing the Angle of the Monitor

The angle of the monitor can be lowered down to approx. 85° or raised upward to approx. 90°. This is convenient when taking images with the camera held at high or low positions.

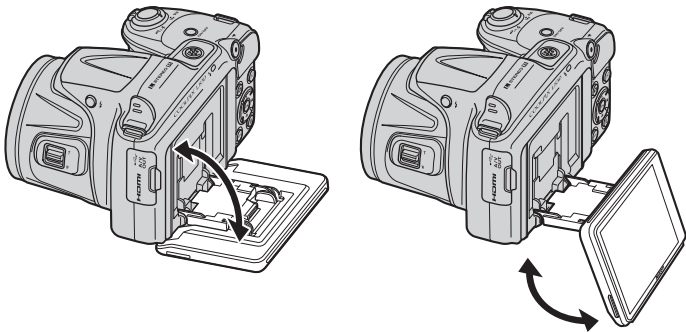

### Notes About Monitor

- Do not apply excessive force when changing the angle of the monitor.
- The monitor cannot be moved to the left or right.
- Put the monitor back in the original position when using in normal situations.

## Attaching the Camera Strap and Lens Cap

Attach the lens cap to the camera strap, and then attach the strap to the camera.

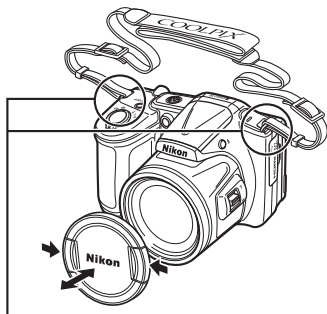
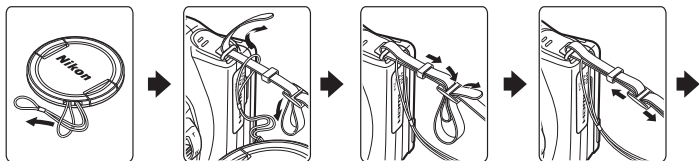

Attach them at two places.

### Lens Cap

When the camera is not in use, protect the lens by attaching the lens cap.

## Raising and Lowering the Flash

Press the  (flash pop-up) button to raise the flash.

- See “Using the Flash” (📖 44) for more information about flash settings.
- Push the flash down gently to lower the flash until it clicks into place when not in use.

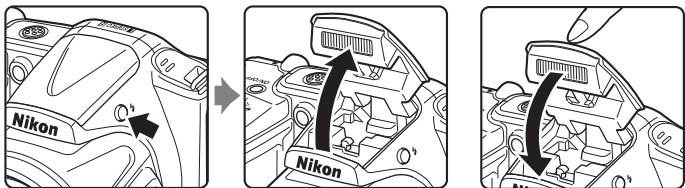

# Using Menu (the MENU Button)

Use the multi selector and **OK** button to navigate the menus.

## 1 Press the MENU button.

- The menu is displayed.

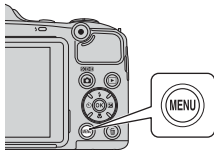

## 2 Press the multi selector ◀.

- The current menu icon is displayed in yellow.

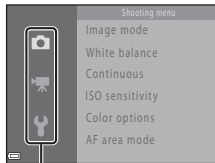

Menu icons

## 3 Select the desired menu icon.

- The menu is changed.

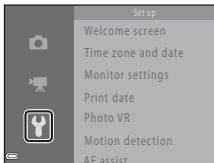

## 4 Press the OK button.

- The menu options become selectable.

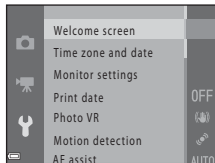

## 5 Select a menu option.

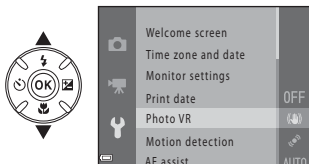

## 6 Press the OK button.

- The settings for the option you selected are displayed.



## 7 Select a setting.

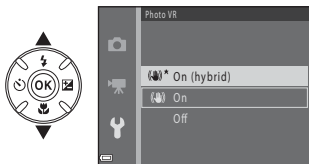



## 8 Press the OK button.

- The setting you selected is applied.
- When you are finished using the menu, press the **MENU** button.



### Notes About Setting Menu Options

- Certain menu options cannot be set depending on the current shooting mode or the state of the camera. Unavailable options are displayed in gray and cannot be selected.
- When a menu is displayed, you can switch to shooting mode by pressing the shutter-release button,  (shooting mode) button, or  (movie-record) button.

# The Monitor



The information that is displayed in the monitor during shooting and playback changes depending on the camera's settings and state of use.

By default, information is displayed when the camera is first turned on and when you operate the camera, and turns off after a few seconds (when **Photo info** is set to **Auto info** in **Monitor settings** (📖 72)).

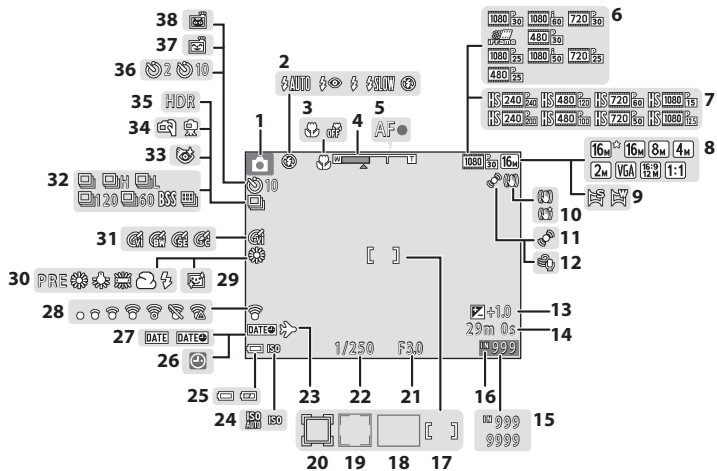
## Shooting Mode









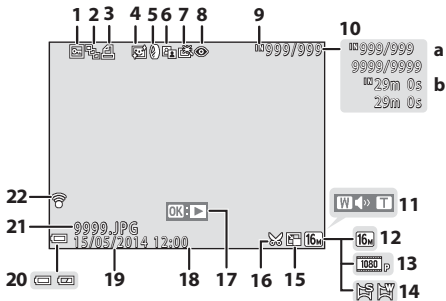











<b>1</b>	Shooting mode.....	22, 23	<b>20</b>	Focus area (subject tracking).....	54,  39
<b>2</b>	Flash mode.....	44	<b>21</b>	Aperture value .....	27
<b>3</b>	Macro mode.....	49	<b>22</b>	Shutter speed.....	27
<b>4</b>	Zoom indicator.....	25, 49	<b>23</b>	Travel destination icon .....	72
<b>5</b>	Focus indicator.....	26	<b>24</b>	ISO sensitivity.....	54
<b>6</b>	Movie options (normal speed movies)...	69	<b>25</b>	Battery level indicator .....	20
<b>7</b>	Movie options (HS movies) .....	69	<b>26</b>	“Date not set” indicator.....	16, 72
<b>8</b>	Image mode.....	54,  27	<b>27</b>	Print date.....	72
<b>9</b>	Easy panorama.....	36	<b>28</b>	Eye-Fi communication indicator .....	73
<b>10</b>	Vibration reduction icon .....	69, 72	<b>29</b>	Skin softening.....	54
<b>11</b>	Motion detection icon .....	72	<b>30</b>	White balance mode .....	54
<b>12</b>	Wind noise reduction .....	69	<b>31</b>	Color options.....	54
<b>13</b>	Exposure compensation value .....	50	<b>32</b>	Continuous shooting mode .....	37, 54
<b>14</b>	Movie recording time remaining .....	65	<b>33</b>	Blink proof icon .....	54
<b>15</b>	Number of exposures remaining (still images) .....	20	<b>34</b>	Hand-held/tripod.....	33, 34
<b>16</b>	Internal memory indicator.....	20	<b>35</b>	Backlighting (HDR) .....	35
<b>17</b>	Focus area (for manual or center) ...	54, 61	<b>36</b>	Self-timer indicator .....	47
<b>18</b>	Focus area (target finding AF) .....	54, 59	<b>37</b>	Smile timer .....	54
<b>19</b>	Focus area (face detection, pet detection).....	26, 37, 40, 54, 57	<b>38</b>	Pet portrait auto release .....	37

# Playback Mode



<b>1</b>	Protect icon.....	64, 	46
<b>2</b>	Sequence display (when <b>Individual pictures</b> is selected).....	64, 	51
<b>3</b>	Print order icon.....	64, 	42
<b>4</b>	Skin softening icon.....	64, 	11
<b>5</b>	Filter effects icon.....	64, 	12
<b>6</b>	D-Lighting icon.....	64, 	9
<b>7</b>	Quick retouch icon.....	64, 	9
<b>8</b>	Red-eye correction icon.....	64, 	10
<b>9</b>	Internal memory indicator.....		15
<b>10</b>	(a) Current image number/ total number of images (b) Movie length		
<b>11</b>	Volume indicator.....		70
<b>12</b>	Image mode.....	54, 	27
<b>13</b>	Movie options.....	69, 	52
<b>14</b>	Easy panorama.....	36, 	2
<b>15</b>	Crop icon.....	62, 	15
<b>16</b>	Small picture icon.....	64, 	14
<b>17</b>	Easy panorama playback guide... Sequence playback guide..... Movie playback guide.....	36,  64,  70	5 6 70
<b>18</b>	Time of recording.....		16
<b>19</b>	Date of recording.....		16
<b>20</b>	Battery level indicator.....		20
<b>21</b>	File number and type.....		77
<b>22</b>	Eye-Fi communication indicator.....		73, 

# The Basics of Shooting and Playback

## Preparation 1 Insert the Batteries

- 1 Open the battery-chamber/memory card slot cover.

- Hold the camera upside down to prevent the batteries from falling out.

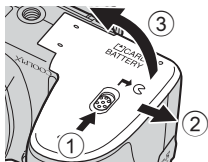

- 2 Insert the batteries.

- Confirm that the positive (+) and negative (-) terminals are oriented correctly and insert the batteries.

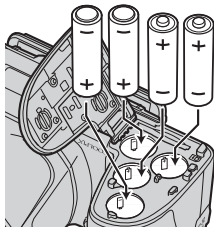

- 3 Close the battery-chamber/memory card slot cover.

- Slide the cover while securely holding down the area marked (2).

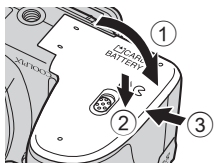

## Applicable Batteries

- Four LR6/L40 (AA-size) alkaline batteries (included batteries)
- Four FR6/L91 (AA-size) lithium batteries
- Four EN-MH2 rechargeable Ni-MH (nickel metal hydride) batteries
- \* EN-MH1 rechargeable Ni-MH batteries cannot be used.

### ✓ Removing the Batteries

- Turn the camera off and make sure that the power-on lamp and the monitor have turned off, and then open the battery-chamber/memory card slot cover.
- The camera, batteries, and memory card may be hot immediately after using the camera.

### ✓ Notes About the Batteries

- Do not combine old and new batteries or batteries of different makes or types.
- Batteries with the following defects cannot be used:

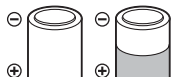

Batteries with peeling



Batteries with insulation that does not cover the area around the negative terminal

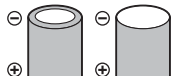

Batteries with a flat negative terminal

### ✓ Battery Type

By setting **Battery type** in the setup menu (📖 72) to match the type of batteries inserted in the camera, the batteries can perform more efficiently.

The default setting is the type of batteries included with purchase.

### ✓ Notes About EN-MH2 Rechargeable Batteries

When using EN-MH2 batteries with the camera, charge four batteries at a time using Battery Charger MH-73 (🔌 78, 🔌 4).

### ✍ Alkaline Batteries

Performance of alkaline batteries may vary greatly depending on the manufacturer. Choose a reliable brand.

## Preparation 2 Insert a Memory Card

- 1** Turn off the camera and open the battery-chamber/memory card slot cover.

- Hold the camera upside down to prevent the batteries from falling out.

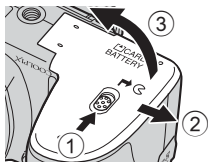

- 2** Insert the memory card.

- Slide the memory card in until it clicks into place.

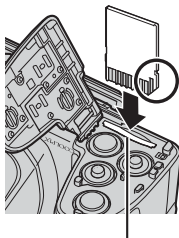

Memory card slot



**Be Careful to Insert the Memory Card in Correct Direction**

*Inserting the memory card upside down or backwards could damage the camera and the memory card.*



- 3** Close the battery-chamber/memory card slot cover.

- Slide the cover while securely holding down the area marked ②.

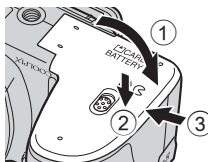

## ✓ Formatting Memory Cards

The first time you insert a memory card that has been used in another device into this camera, make sure to format it with this camera. Insert the card into the camera, press the **MENU** button, and select **Format card** in the setup menu.

## Removing Memory Cards

Turn the camera off and make sure that the power-on lamp and the monitor have turned off, and then open the battery-chamber/memory card slot cover.

Gently push the memory card into the camera (①) to partially eject the card (②).

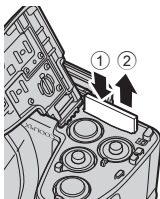

## ✓ High Temperature Caution

The camera, batteries, and memory card may be hot immediately after using the camera.

## Internal Memory and Memory Cards

Camera data, including images and movies, can be saved either in the camera's internal memory or on a memory card. To use the camera's internal memory, first remove the memory card.



## Preparation 3 Setting the Display Language, Date, and Time

When the camera is turned on for the first time, the language-selection screen and the date and time setting screen for the camera clock are displayed.

- If you exit without setting the date and time,  will flash when the shooting screen is displayed.

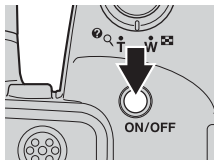
- 1 Press the power switch to turn on the camera.



- 2 Use the multi selector   to select the desired language and press the  button.

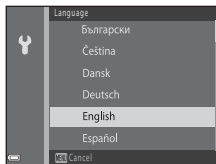

- 3 Select **Yes** and press the  button.

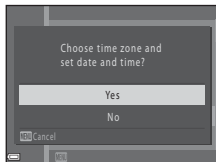



#### 4 Select your home time zone and press the **OK** button.

- To enable daylight saving time, press ▲. When the daylight saving time function is enabled, ☀ is displayed above the map. To turn off the daylight saving time function, press ▼.

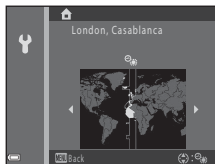

#### 5 Select the date format and press the **OK** button.

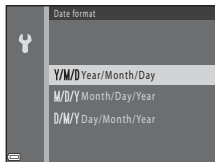

#### 6 Set the date and time, and press the **OK** button.

- Select a field: Press ◀▶ (changes between **D**, **M**, **Y**, **h**, and **m**).
- Edit the date and time: Press ▲▼.
- Confirm the setting: Select **m** and press the **OK** button.

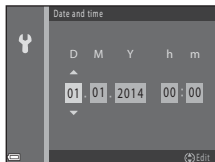

#### 7 Select **Yes** and press the **OK** button.

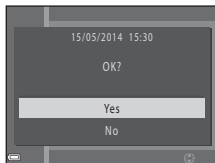



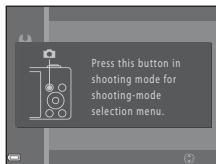

## 8 Make sure that the lens cap has been removed and press the button.

- The shooting-mode selection screen is displayed.







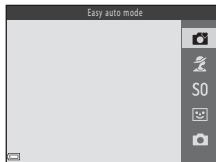

## 9 When **Easy auto mode** is displayed, press the button.

- The camera enters the shooting mode and you can take images in Easy auto mode ( 22).
- To switch to another shooting mode, press   before pressing the .





## Changing the Language Setting and the Date and Time Setting

- You can change these settings using the **Language** and **Time zone and date** settings in the  setup menu ( 72).
- You can enable or disable daylight saving time in the  setup menu by selecting **Time zone and date** followed by **Time zone**. Press the multi selector  and then  to enable daylight saving time and move the clock forward one hour, or  to disable daylight saving time and move the clock back one hour.

## The Clock Battery

- The camera's clock is powered by a built-in backup battery. The backup battery charges when the main batteries are inserted into the camera or when the camera is connected to an optional AC adapter, and it can run the clock for several days after about ten hours of charging.
- If the camera's backup battery becomes exhausted, the date and time setting screen is displayed when the camera is turned on. Set the date and time again. See step 3 ( 16) of "Preparation 3 Setting the Display Language, Date, and Time" for more information.

## Imprinting the Shooting Date on Printed Images

- You can permanently imprint the shooting date on images as they are captured by setting **Print date** in the setup menu ( 72).
- If you want the shooting date to be printed without using the **Print date** setting, print using the ViewNX 2 software ( 76).

# Step 1 Turn the Camera On

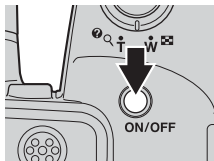

## 1 Remove the lens cap and press the power switch.

- The monitor turns on.
- To turn the camera off, press the power switch again.



## 2 Check the battery level indicator and the number of exposures remaining.

### Battery level indicator

Display	Description
	The battery level is high.
	The battery level is low.
<b>Battery exhausted.</b>	The camera cannot capture images. Replace the batteries.

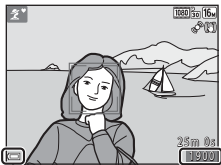

Battery level indicator



Number of exposures remaining

### Number of Exposures Remaining

The number of images that can be taken is displayed.





-  is displayed when no memory card is inserted in the camera, and images are saved in the internal memory.

## Notes About the Flash

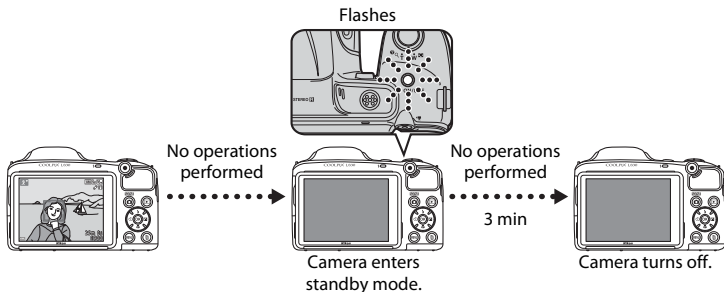
When you need to use the flash, such as when shooting in dark locations or when the subject is backlit, press the  (flash pop-up) button to raise the flash ( 5, 44).

## The Auto Off Function





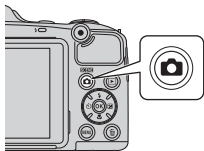

- The time that elapses before the camera enters standby mode is about 30 seconds. The time can be changed using the **Auto off** setting in the setup menu ( 72).
- While the camera is in standby mode, the monitor turns back on if you perform any of the following operations:
  - Press the power switch, shutter-release button,  (shooting mode) button,  (playback) button, or  (movie-record) button

## Step 2 Select a Shooting Mode

1 Press the  button.



2 Use the multi selector   to select a shooting mode and press the  button.

-  (easy auto) mode is used in this example.
- The shooting mode setting is saved even after the camera is turned off.

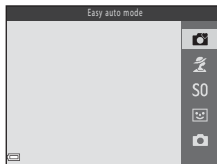

## Available Shooting Modes



### Easy auto mode

31

The camera automatically selects the optimum scene mode when you frame an image, making it even easier to take images using settings that suit the scene.



### Scene mode

32

Camera settings are optimized according to the scene that you select.



### Special effects

38

Effects can be applied to images during shooting.



### Smart portrait

40

When the camera detects a smiling face, you can take an image automatically without pressing the shutter-release button (smile timer). You can also use the skin softening option to smooth the skin tones of human faces.



### Auto mode

42

Used for general shooting. Settings can be adjusted to suit the shooting conditions and the type of shot you want to capture.

## Step 3 Frame a Picture

### 1 Hold the camera steady.

- Keep fingers and other objects away from the lens, flash, AF-assist illuminator, microphone, and speaker.

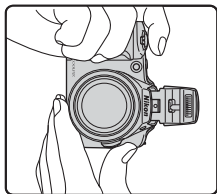
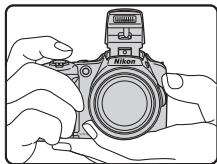

### 2 Frame the picture.

- When the camera automatically determines the scene mode, the shooting mode icon changes (📖 31).

Shooting mode icon

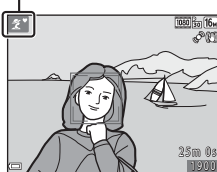

### ✓ Notes About Easy Auto Mode

- Depending upon shooting conditions, the camera may not select the desired scene mode. In this case, select another shooting mode (📖 32, 38, 40, 42).
- When the digital zoom is in effect, the scene mode changes to 📺.



## When Using a Tripod

- We recommend using a tripod to stabilize the camera in the following situations.
  - When shooting in dim lighting
  - When the flash is lowered or when using a shooting mode in which the flash does not fire
  - When using the telephoto setting
- When using a tripod to stabilize the camera during shooting, set **Photo VR** to **Off** in the setup menu (📖 72) to prevent potential errors caused by this function.

## Using the Zoom

When you move the zoom control, the zoom lens position changes.

- To zoom in closer to the subject: Move toward **T** (telephoto)
- To zoom out and view a larger area: Move toward **W** (wide-angle)

When you turn the camera on, the zoom moves to the maximum wide-angle position.

- The side zoom control (📖 1) can also be moved toward **T** or **W** to operate the zoom.

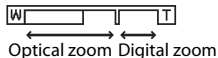
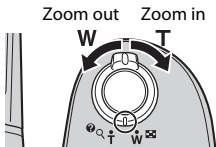

- A zoom indicator is displayed at the top of the monitor when the zoom control is moved.
- Digital zoom, which allows you to further magnify the subject up to approximately 4x the maximum optical zoom ratio, can be activated by moving and holding the zoom control or the side zoom control toward **T** when the camera is zoomed in to the maximum optical zoom position.

## Notes About Digital Zoom

The zoom indicator turns blue when the digital zoom is activated, and it turns yellow when the zoom magnification is increased further.

- Zoom indicator is blue: Image quality is not noticeably reduced by using the Dynamic Fine Zoom.
- Zoom indicator is yellow: Image quality is noticeably reduced.
- The indicator remains blue across a wider area when the image size is smaller.

## Step 4 Focus and Shoot

### 1 Press the shutter-release button halfway.

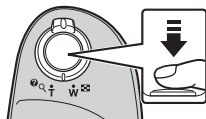

- When the subject is in focus, the focus area glows green (multiple focus areas can glow green).
- When you are using digital zoom, the camera focuses on the subject in the center of the frame and the focus area is not displayed. When the camera has focused, the focus indicator (📖 9) glows green.
- If the focus area or focus indicator flashes, the camera is unable to focus. Modify the composition and try pressing the shutter-release button halfway again.



### 2 Without lifting your finger, press the shutter-release button the rest of the way down.



## The Shutter-release Button

<p>Press halfway</p>		<p>To set focus and exposure (shutter speed and aperture value), press the shutter-release button lightly until you feel a slight resistance. Focus and exposure remain locked while the shutter-release button is pressed halfway.</p>
<p>Press all the way</p>		<p>Press the shutter-release button all the way to release the shutter and take an image. Do not use force when pressing the shutter-release button, as this may result in camera shake and blurred images. Press the button gently.</p>

### Notes About Saving Images and Recording Movies

The indicator showing the number of exposures remaining or the indicator showing the maximum movie length flashes while images are being saved or while a movie is being recorded. **Do not open the battery-chamber/memory card slot cover or remove the batteries or memory card** while an indicator is flashing. Doing this could result in loss of data, or in damage to the camera or the memory card.



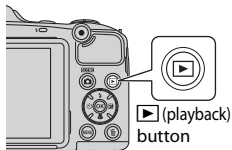

## Step 5 Play Back Images

### 1 Press the (playback) button.

- If you press and hold down the  (playback) button while the camera is turned off, the camera turns on in playback mode.



### 2 Use the multi selector to select an image to display.

- Press and hold down    to scroll through the images quickly.
- To return to shooting mode, press the  button or shutter-release button.

Display the previous image

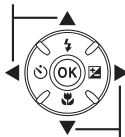





Display the next image

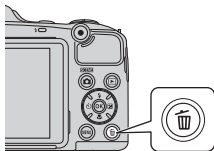

## Step 6 Delete Images

- 1 Press the  button to delete the image currently displayed in the monitor.



- 2 Use the multi selector   to select the desired deletion method and press the  button.

- To exit without deleting, press the **MENU** button.

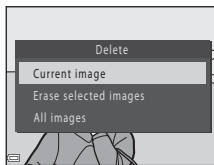

- 3 Select **Yes** and press the  button.

- Deleted images cannot be recovered.
- To cancel, select **No** and press the  button.

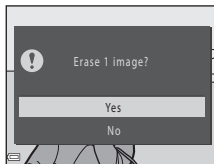

## Operating the Erase Selected Images Screen

**1** Use the multi selector ◀▶ to select an image to be deleted, and then use ▲ to display 🗑️.

- To undo the selection, press ▼ to remove 🗑️.
- Move the zoom control (📐 1) toward **T** (🔍) to switch to full-frame playback or **W** (🖼️) to switch to thumbnail playback.



**2** Add 🗑️ to all images that you want to delete and then press the **OK** button to confirm the selection.

- A confirmation dialog is displayed. Follow the instructions displayed in the monitor.

### ✓ Deleting Images in a Sequence

- If you press the 🗑️ button and delete a key picture while only key pictures are displayed for sequences of images (📖 64), all images in the sequence, including the key picture, are deleted.
- To delete individual images in a sequence, press the **OK** button to display them one at a time and press the 🗑️ button.



### ✍️ Deleting the Last Image Captured While in Shooting Mode

When using shooting mode, press the 🗑️ button to delete the last image that was saved.







# Shooting Features

## (Easy Auto) Mode

The camera automatically selects the optimum scene mode when you frame an image, making it even easier to take images using settings that suit the scene.



Enter shooting mode →  (shooting mode) button →  (easy auto) mode →  button

When the camera selects a scene mode, the shooting mode icon displayed in the shooting screen changes to that for the scene mode currently enabled.

	Portrait
	Landscape
	Night portrait*
	Night landscape*
	Close-up
	Backlighting
	Other scenes







\* One image is captured at a slow shutter speed.

## Functions Available in (Easy Auto) Mode































- Self-timer ( 47)
- Exposure compensation ( 50)
- Easy auto mode menu ( 53)

## Scene Mode (Shooting Suited to Scenes)

When a scene is selected, camera settings are automatically optimized for the selected scene.

Enter shooting mode →  (shooting mode) button →  (second icon from the top\*) →    → select a scene →  button

\* The icon of the last scene selected is displayed.



 Portrait (default setting)	 Landscape <sup>2</sup>	 Sports <sup>1</sup> (  33)	 Night portrait (  33)
 Party/indoor <sup>1</sup> (  33)	 Beach <sup>1</sup>	 Snow <sup>1</sup>	 Sunset <sup>1,3</sup>
 Dusk/dawn <sup>2,3</sup>	 Night landscape <sup>2</sup> (  34)	 Close-up (  34)	 Food (  34)
 Museum <sup>1</sup> (  35)	 Fireworks show <sup>2,3</sup> (  35)	 Black and white copy <sup>1</sup> (  35)	 Backlighting (  35)
 Easy panorama <sup>1</sup> (  36)	 Pet portrait (  37)		

<sup>1</sup> The camera focuses on the area in the center of the frame.

<sup>2</sup> The camera focuses at infinity.

<sup>3</sup> Use of a tripod is recommended, because the shutter speed is slow. Set **Photo VR** to **Off** in the setup menu ( 72) when using a tripod to stabilize the camera during shooting.

### To View a Description (Help Display) of Each Scene

Select a scene and move the zoom control ( 1) toward **T** () to view a description of that scene. To return to the original screen, move the zoom control toward **T** () again.

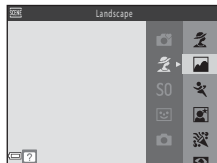









# Tips and Notes

## Sports

- While the shutter-release button is held all the way down, the camera shoots up to about 5 images continuously at a rate of about 6.7 fps (when **Image mode** is set to **16M 4608x3456**).
- The frame rate for continuous shooting may vary depending upon the current image mode setting, the memory card used, or shooting condition.
- Focus, exposure, and hue are fixed at the values determined with the first image in each series.







## Night portrait

- Raise the flash before shooting.
- From the screen displayed after  **Night portrait** is selected, select  **Hand-held** or  **Tripod**.
-  **Hand-held** (default setting):
  - When the  icon at the top left of the monitor glows green, press the shutter-release button all the way to capture a series of images which are combined into a single image and saved.
  - Once the shutter-release button is pressed all the way, hold the camera still until a still image is displayed. After taking an image, do not turn the camera off before the monitor switches to the shooting screen.
  - If the subject moves while the camera is shooting continuously, the image may be distorted, overlapped, or blurred.
-  **Tripod**:
  - One image is captured at a slow shutter speed when the shutter-release button is pressed all the way.
  - Vibration reduction is disabled even when **Photo VR** ( 72) in the setup menu is set to **On**.





## Party/indoor

- To avoid the effects of camera shake, hold the camera steady. Set **Photo VR** to **Off** in the setup menu ( 72) when using a tripod to stabilize the camera during shooting.





## Night landscape

- From the screen displayed after  **Night landscape** is selected, select  **Hand-held** or  **Tripod**.
-  **Hand-held** (default setting):
  - When the  icon at the top left of the monitor glows green, press the shutter-release button all the way to capture a series of images which are combined into a single image and saved.
  - Once the shutter-release button is pressed all the way, hold the camera still until a still image is displayed. After taking an image, do not turn the camera off before the monitor switches to the shooting screen.
-  **Tripod**:
  - One image is captured at a slow shutter speed when the shutter-release button is pressed all the way.
  - Vibration reduction is disabled even when **Photo VR** ( 72) in the setup menu is set to **On**.

## Close-up

- Macro mode ( 49) is enabled and the camera automatically zooms to the closest position at which it can focus.
- You can move the focus area. Press the  button, use the multi selector  to move the focus area, and press the  button to apply the setting.

## Food

- Macro mode ( 49) is enabled and the camera automatically zooms to the closest position at which it can focus.
- You can adjust hue by using the multi selector . The hue setting is saved in the camera's memory even after the camera is turned off.
- You can move the focus area. Press the  button, use the multi selector  to move the focus area, and press the  button to apply the setting.

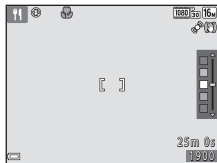

## Museum

- The camera captures a series of up to ten images while the shutter-release button is held all the way down, and the sharpest image in the series is automatically selected and saved (BSS (Best Shot Selector)).
- The flash does not fire.



## Fireworks show

- The shutter speed is fixed at about four seconds.
- 13 zoom positions are available.





## Black and white copy

- Use together with macro mode ( 49) when shooting subjects that are close to the camera.

## Backlighting

- From the screen displayed after  **Backlighting** is selected, select **ON** or **OFF** to enable or disable the high dynamic range (HDR) function based on the type of image you want to take.
- **OFF** (default setting): The flash fires to prevent the subject from being hidden in shadow. Raise the flash before shooting.
  - When the shutter-release button is pressed all the way down, one image is captured.
- **ON**: Use when taking images with very bright and dark areas in the same frame.
  - When the shutter-release button is pressed all the way, the camera shoots images continuously at high speed, and saves the following two images.
    - A non-HDR composite image
    - An HDR composite image in which the loss of details in highlights or shadows is minimized
  - If there is only enough memory to save one image, an image processed by D-Lighting ( 64) at the time of shooting, in which dark areas of the image are corrected, is the only image saved.
  - Once the shutter-release button is pressed all the way, hold the camera still until a still image is displayed. After taking an image, do not turn the camera off before the monitor switches to the shooting screen.
  - The angle of view (i.e., the area visible in the frame) seen in the saved image is narrower than that seen in the monitor at the time of shooting.





## Easy panorama

- From the screen displayed after  **Easy panorama** is selected, select the shooting range from  **Normal (180°)** or  **Wide (360°)**.
- The zoom position is fixed at wide-angle.
- Press the shutter-release button all the way down, remove your finger from the button, and then slowly pan the camera horizontally. Shooting ends when the camera captures the specified shooting range.
- Focus and exposure are locked when shooting starts.
- If you press the  button when a captured image is displayed in full-frame playback mode, the image scrolls automatically.
- The images cannot be edited using any editing functions other than crop on this camera.  
→ "Using Easy Panorama (Shooting and Playback)" ( 2)



### **Notes About Printing Panorama Images**

The entire image may not be able to be printed depending on the printer's settings. Additionally, printing may not be possible depending on the printer.

## Pet portrait

- When you point the camera at a dog or cat, the camera detects the pet's face and focuses on it. By default, the shutter is automatically released when the camera detects a dog or cat face (pet portrait auto release).
- From the screen displayed after  **Pet portrait** is selected, select  **Single** or  **Continuous**.
  -  **Single**: Whenever the camera detects a dog or cat face, it captures one image.
  -  **Continuous**: Whenever the camera detects a dog or cat face, it captures three images continuously.

## **Pet Portrait Auto Release**

- Press the multi selector  to change the **Pet portrait auto release** settings.
  - : The shutter is automatically released when the camera detects a dog or cat face.
  - **OFF**: The camera does not release the shutter automatically, even if a dog or cat face is detected. Press the shutter-release button. The camera also detects human faces when **OFF** is selected.
- **Pet portrait auto release** is set to **OFF** after five bursts have been taken.
- Shooting is also possible by pressing the shutter-release button, regardless of the **Pet portrait auto release** setting.





## **Focus Area**

- When the camera detects a face, the face is displayed inside a yellow border. When the camera acquires focus on a face displayed inside a double border (focus area), the double border turns green. If no faces are detected, the camera focuses on the subject in the center of the frame.
- In some shooting conditions, the pet face may not be detected and other subjects may be displayed inside a border.











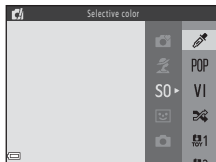



## Special Effects Mode (Applying Effects When Shooting)

Effects can be applied to images during shooting.

Enter shooting mode →  (shooting mode) button → SO (third icon from the top\*) →    → select an effect →  button

\* The icon of the last effect selected is displayed.



Category	Description
 Soft (default setting)	Softens the image by adding a slight blur to the entire image.
 Nostalgic sepia	Adds a sepia tone and reduces the contrast to simulate the qualities of an old photograph.
 High-contrast monochrome	Changes the image to black and white and gives it sharp contrast.
 High key	Gives the entire image a bright tone.
 Low key	Gives the entire image a dark tone.
 Selective color	Creates a black and white image in which only the specified color remains.
 Pop	Increases the color saturation of the entire image to create a bright look.
 Super vivid	Increases the color saturation of the entire image and sharpens the contrast.
 Cross process	Gives the image a mysterious appearance based on a specific color.
 Toy camera effect 1	Gives the entire image a yellowish hue and darkens the image periphery.
 Toy camera effect 2	Decreases the color saturation of the entire image and darkens the image periphery.

- The camera focuses on the area in the center of the frame.
- When **Selective color** or **Cross process** is selected, use the multi selector ▲▼ to select the desired color from the slider.

To change settings for any of the following functions, press the **OK** button to cancel color selection.

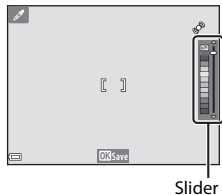

- Flash mode (📖 44)
- Self-timer (📖 47)
- Macro mode (📖 49)
- Exposure compensation (📖 50)

To return to the color selection screen, press the **OK** button again.



## Smart Portrait Mode (Capturing Images of Smiling Faces)

When the camera detects a smiling face, you can take an image automatically without pressing the shutter-release button (smile timer (📖 53)). You can use the skin softening option to smooth the skin tones of human faces.

Enter shooting mode →  (shooting mode) button →  Smart portrait mode → 

### 1 Frame the picture.

- Point the camera at a human face.

### 2 Without pressing the shutter-release button, wait for the subject to smile.

- If the camera detects that the face framed by the double border is smiling, the shutter is automatically released.
- Whenever the camera detects a smiling face, it automatically releases the shutter.

### 3 End automatic shooting.

- Perform one of the operations listed below to end shooting.
  - Set **Smile timer** to **Off**.
  - Press the  button and select a different shooting mode.

### Notes About Smart Portrait Mode

Under some shooting conditions, the camera may be unable to detect faces or detect smiles (📖 58). The shutter-release button can also be used for shooting.

### When the Self-timer Lamp Flashes

When using smile timer, the self-timer lamp flashes when the camera detects a face and flashes quickly immediately after the shutter is released.





## Functions Available in Smart Portrait Mode

- Flash mode (📖 44)
- Self-timer (📖 47)
- Exposure compensation (📖 50)
- Smart portrait menu (📖 53)





## (Auto) Mode

Used for general shooting. Settings can be adjusted to suit the shooting conditions and the type of shot you want to capture.

Enter shooting mode →  (shooting mode) button →  (auto) mode →  button

- You can change how the camera selects the area of the frame to focus on by changing the **AF area mode** setting ( 54).  
The default setting is **Target finding AF** ( 59).

### Functions Available in (Auto) Mode

- Flash mode ( 44)
- Self-timer ( 47)
- Macro mode ( 49)
- Exposure compensation ( 50)
- Shooting menu ( 53)

## Functions That Can Be Set Using the Multi Selector

The functions that are available vary with the shooting mode, as shown below.

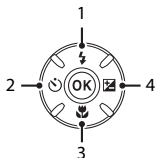

		📷 (easy auto)	Scene	Special effects	Smart portrait	📷 (auto)
1	⚡ Flash mode <sup>1</sup> (📖 44)	–	2	✓	✓ <sup>2</sup>	✓
2	🕒 Self-timer (📖 47)	✓		✓	✓ <sup>2</sup>	✓
3	🌸 Macro (📖 49)	–		✓	–	✓
4	📏 Exposure compensation (📖 50)	✓		✓	✓	✓

<sup>1</sup> Can be set when the flash is raised. The flash does not fire while it is lowered.

<sup>2</sup> Availability depends on the setting.

## Using the Flash

In dark locations or when the subject is backlit, you can take images with the flash by raising the flash.

When using  (auto) mode and other shooting modes, you can select the flash mode to match the shooting conditions.

### 1 Press the (flash pop-up) button.

- The flash pops up.
- The flash does not fire while it is lowered.  is displayed to indicate that the flash does not fire.

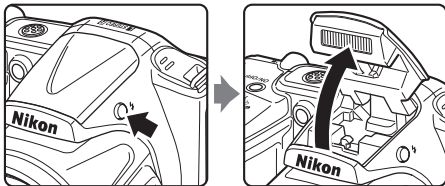

### 2 Press the multi selector ().



### 3 Select the desired flash mode ( 45) and press the button.

- If a setting is not applied by pressing the  button within a few seconds, the selection will be canceled.

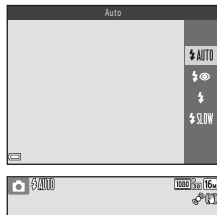

## Available Flash Modes

### AUTO Auto

The flash fires when necessary, such as in dim lighting.

- The flash mode icon on the shooting screen is displayed only immediately after the setting is made.

### Auto with red-eye reduction

Reduce red-eye in portraits caused by the flash ( 46).

### Fill flash

The flash fires whenever an image is taken. Use to “fill-in” (illuminate) shadows and backlit subjects.

### SLOW Slow sync

Suited to evening and night portraits that include background scenery. The flash fires when necessary to illuminate the main subject; slow shutter speeds are used to capture background at night or under dim lighting.

## ✓ Lowering the Flash

Push the flash down gently to lower the flash until it clicks into place when not in use (📖 5).

## 🔗 The Flash Lamp

The status of the flash can be confirmed by pressing the shutter-release button halfway.

- On: The flash fires when you press the shutter-release button all the way down.
- Flashing: The flash is charging. The camera cannot shoot images.
- Off: The flash does not fire when an image is taken.

If the battery level is low, the monitor turns off while the flash is charging.

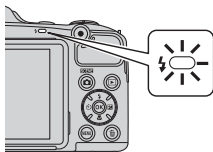

## 🔗 The Flash Mode Setting

- The setting may not be available with some shooting modes.
- The setting applied in 📷 (auto) mode is saved in the camera's memory even after the camera is turned off.

## 🔗 Red-eye Reduction

Pre-flashes are fired repeatedly at low intensity before the main flash, reducing the red-eye effect. Additionally, if the camera detects red eye while saving an image, the affected area is processed to reduce red-eye before the image is saved.

Note the following when shooting:

- Because pre-flashes are fired, there is a slight lag between when the shutter-release button is pressed and when the shutter is released.
- More time than usual is required to save images.
- Red-eye reduction may not produce the desired results in all situations.
- In some cases, red-eye reduction may be applied to areas of an image unnecessarily. In these cases, select another flash mode and take the image again.

## Using the Self-timer

The camera is equipped with a self-timer that releases the shutter about ten seconds or two seconds after you press the shutter-release button.

Set **Photo VR to Off** in the setup menu (📖 72) when using a tripod to stabilize the camera during shooting.

**1** Press the multi selector ◀ (👁).



**2** Select 👁10s or 👁2s, and press the **OK** button.

- 👁10s (ten seconds): Use on important occasions, such as weddings.
- 👁2s (two seconds): Use to prevent camera shake.
- If a setting is not applied by pressing the **OK** button within a few seconds, the selection will be canceled.
- When the shooting mode is **Pet portrait** scene mode,  (pet portrait auto release) is displayed (📖 37). The self-timer cannot be used.

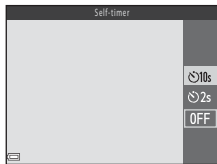

**3** Frame the picture and press the shutter-release button halfway.

- Focus and exposure are set.



## 4 Press the shutter-release button the rest of the way down.

- Countdown starts. The self-timer lamp flashes and then glows steadily about one second before the shutter is released.
- When the shutter is released, the self-timer is set to **OFF**.
- To stop the countdown, press the shutter-release button again.

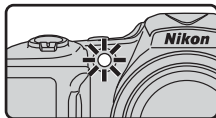
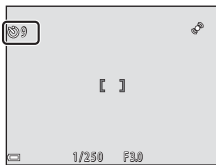



# Using Macro Mode

Use macro mode when taking close-up images.

- 1 Press the multi selector ▼ (🔍).



- 2 Select **ON** and press the **OK** button.

- If a setting is not applied by pressing the **OK** button within a few seconds, the selection will be canceled.

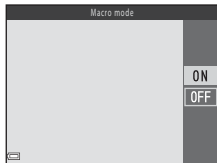

- 3 Move the zoom control to set the zoom ratio to a position where 🔍 and the zoom indicator glow green.

- When the zoom ratio is set to a position where 🔍 and the zoom indicator glow green, the camera can focus on subjects as close as approximately 5 cm (2 in.) from the lens.
- When the zoom position is in the area indicated by ①, the camera can focus on subjects as close as approximately 1 cm (0.4 in.) from the lens.

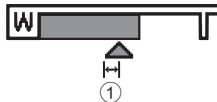

## ✓ Notes About Using the Flash

The flash may be unable to light the entire subject at distances of less than 50 cm (1 ft 8 in.).

## ✎ The Macro Mode Setting

- The setting may not be available with some shooting modes.
- The setting applied in 📷 (auto) mode is saved in the camera's memory even after the camera is turned off.

# Adjusting Brightness (Exposure Compensation)

You can adjust overall image brightness.

**1** Press the multi selector ► (◻/◻).



**2** Select a compensation value and press the **OK** button.

- To brighten the image, set a positive (+) value.
- To darken the image, set a negative (-) value.
- The compensation value is applied, even without pressing the **OK** button.

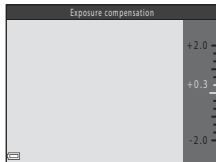



































































## **Exposure Compensation Value**

The setting applied in  (auto) mode is saved in the camera's memory even after the camera is turned off.

## Default Settings

Default settings for each shooting mode are described below.

	Flash <sup>1</sup> (  44)	Self-timer (  47)	Macro (  49)	Exposure compensation (  50)
 (easy auto)	 AUTO <sup>2</sup>	Off	Off <sup>3</sup>	0.0
Scene				
 (portrait)	 	Off	Off <sup>4</sup>	0.0
 (landscape)	  <sup>4</sup>	Off	Off <sup>4</sup>	0.0
 (sports)	  <sup>4</sup>	Off <sup>4</sup>	Off <sup>4</sup>	0.0
 (night portrait)	  <sup>4</sup>	Off	Off <sup>4</sup>	0.0
 (party/indoor)	  <sup>5</sup>	Off	Off <sup>4</sup>	0.0
 (beach)	 AUTO	Off	Off <sup>4</sup>	0.0
 (snow)	 AUTO	Off	Off <sup>4</sup>	0.0
 (sunset)	  <sup>4</sup>	Off	Off <sup>4</sup>	0.0
 (dusk/dawn)	  <sup>4</sup>	Off	Off <sup>4</sup>	0.0
 (night landscape)	  <sup>4</sup>	Off	Off <sup>4</sup>	0.0
 (close-up)	 	Off	On <sup>4</sup>	0.0
 (food)	  <sup>4</sup>	Off	On <sup>4</sup>	0.0
 (museum)	  <sup>4</sup>	Off	Off	0.0
 (fireworks show)	  <sup>4</sup>	Off <sup>4</sup>	Off <sup>4</sup>	0.0 <sup>4</sup>
 (black and white copy)	 	Off	Off	0.0
 (backlighting)	  <sup>6</sup>	Off	Off <sup>4</sup>	0.0
 (easy panorama)	  <sup>4</sup>	Off <sup>4</sup>	Off <sup>4</sup>	0.0
 (pet portrait)	  <sup>4</sup>	 <sup>7</sup>	Off	0.0
SO (special effects)	 AUTO	Off	Off	0.0
 (smart portrait)	 AUTO <sup>8</sup>	Off <sup>9</sup>	Off <sup>4</sup>	0.0
 (auto)	 AUTO	Off	Off	0.0

- 1 The setting that is used when the flash is raised.
- 2 The setting cannot be changed. The camera automatically selects the flash mode appropriate for the scene it has selected.
- 3 The setting cannot be changed. Automatically changes to macro mode when the camera selects **Close-up**.
- 4 The setting cannot be changed.
- 5 Slow sync with red-eye reduction flash mode may be used.
- 6 Flash is fixed at  (fill flash) when **HDR** is set to **OFF**. The flash does not fire when **HDR** is set to **ON**.
- 7 Self-timer cannot be used. Pet portrait auto release can be turned on or off ( 37).
- 8 Cannot be used when **Blink proof** is set to **On**.
- 9 Can be set when **Smile timer** is set to **Off**.

## Functions That Can Be Set with the MENU Button (Shooting Menu)

The settings listed below can be changed by pressing the **MENU** button during shooting.

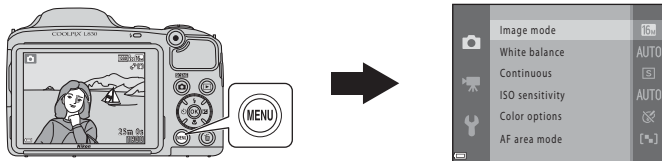













The settings that can be changed vary depending on the shooting mode, as shown below.

	Easy auto mode	Scene	Special effects	Smart portrait	Auto mode
Image mode*	✓	✓	✓	✓	✓
White balance	-	-	-	-	✓
Continuous	-	-	-	-	✓
ISO sensitivity	-	-	-	-	✓
Color options	-	-	-	-	✓
AF area mode	-	-	-	-	✓
Skin softening	-	-	-	✓	-
Smile timer	-	-	-	✓	-
Blink proof	-	-	-	✓	-

\* The setting is also applied to other shooting modes.

## Options Available in the Shooting Menu

Option	Description	
Image mode	Allows you to set the combination of image size and image quality used when saving images. <ul style="list-style-type: none"><li>• Default setting:  <b>4608x3456</b></li></ul>	 27
White balance	Allows you to adjust white balance to suit the weather conditions or light source in order to make the colors in images match what you see with your eyes. <ul style="list-style-type: none"><li>• Default setting: <b>Auto</b></li></ul>	 29
Continuous	Allows you to select single or continuous shooting. <ul style="list-style-type: none"><li>• Default setting: <b>Single</b></li></ul>	 32
ISO sensitivity	Allows you to control the camera's sensitivity to light. <ul style="list-style-type: none"><li>• Default setting: <b>Auto</b></li></ul> When <b>Auto</b> is selected,  <b>ISO</b> is displayed in the monitor while shooting if ISO sensitivity increases.	 34
Color options	Allows you to change the color tones of images. <ul style="list-style-type: none"><li>• Default setting: <b>Standard color</b></li></ul>	 35
AF area mode	Allows you to determine how the camera selects the focus area that is used for autofocus. <ul style="list-style-type: none"><li>• Default setting: <b>Target finding AF</b> ( 59)</li></ul>	 36
Skin softening	Allows you to make the skin tones in human faces smoother. <ul style="list-style-type: none"><li>• Default setting: <b>On</b></li></ul>	 40
Smile timer	Allows you to select whether or not the camera automatically releases the shutter when it detects a human smiling face. <ul style="list-style-type: none"><li>• Default setting: <b>On</b></li></ul>	 40
Blink proof	The camera automatically releases the shutter twice with every shot and saves one image in which the subject's eyes are open. <ul style="list-style-type: none"><li>• Default setting: <b>Off</b></li></ul>	 41

## Functions That Cannot Be Used Simultaneously

Some functions cannot be used with other menu options.

Restricted function	Option	Description
Flash mode	Continuous (📖 54)	When a setting other than <b>Single</b> is selected, the flash cannot be used.
	Blink proof (📖 54)	When <b>Blink proof</b> is set to <b>On</b> , the flash cannot be used.
Self-timer	Smile timer (📖 54)	When <b>Smile timer</b> is selected, the self-timer cannot be used.
	AF area mode (📖 54)	When <b>Subject tracking</b> is selected, the self-timer cannot be used.
Macro mode	AF area mode (📖 54)	When <b>Subject tracking</b> is selected, macro mode cannot be used.
Digital zoom	Continuous (📖 54)	When <b>Multi-shot 16</b> is selected, digital zoom cannot be used.
	AF area mode (📖 54)	When <b>Subject tracking</b> is selected, digital zoom cannot be used.
Image mode	Continuous (📖 54)	<p><b>Image mode</b> is set as follows depending on the continuous shooting setting:</p> <ul style="list-style-type: none"> <li>• <b>Continuous H: 120 fps: VGA</b> (image size: 640 × 480 pixels)</li> <li>• <b>Continuous H: 60 fps: 1M</b> (image size: 1280 × 960 pixels)</li> <li>• <b>Multi-shot 16: 5M</b> (image size: 2560 × 1920 pixels)</li> </ul>
White balance	Color options (📖 54)	When <b>Black-and-white</b> , <b>Sepia</b> , or <b>Cyanotype</b> is selected, the <b>White balance</b> setting is fixed at <b>Auto</b> .
ISO sensitivity	Continuous (📖 54)	When <b>Continuous H: 120 fps</b> , <b>Continuous H: 60 fps</b> , or <b>Multi-shot 16</b> is selected, the <b>ISO sensitivity</b> setting is automatically specified according to the brightness.

Restricted function	Option	Description
AF area mode	White balance (📖 54)	When a setting other than <b>Auto</b> is selected for <b>White balance</b> in <b>Target finding AF</b> mode, the camera does not detect the main subject.
Print date	Continuous (📖 54)	When <b>Continuous H</b> , <b>Continuous L</b> , <b>Continuous H: 120 fps</b> , <b>Continuous H: 60 fps</b> , or <b>BSS</b> is selected, date and time cannot be imprinted on images.
	Blink proof (📖 54)	When <b>Blink proof</b> is set to <b>On</b> , date and time cannot be imprinted on images.
Photo VR	Flash mode (📖 44)	When the flash fires, images cannot be corrected by image processing even when this function is set to <b>On (hybrid)</b> .
	Self-timer (📖 47)	When the self-timer is used, images cannot be corrected by image processing even when this function is set to <b>On (hybrid)</b> .
	Continuous (📖 54)	When <b>Continuous</b> is set to any setting other than <b>Single</b> , images cannot be corrected by image processing even when this function is set to <b>On (hybrid)</b> .
	ISO sensitivity (📖 54)	When ISO sensitivity increases to 400 or higher, images cannot be corrected by image processing even when this function is set to <b>On (hybrid)</b> .
Motion detection	Flash mode (📖 44)	When the flash fires, <b>Motion detection</b> is disabled.
	Continuous (📖 54)	When <b>Continuous H: 120 fps</b> , <b>Continuous H: 60 fps</b> , or <b>Multi-shot 16</b> is selected, <b>Motion detection</b> is disabled.
	ISO sensitivity (📖 54)	When the ISO sensitivity is set to any setting other than <b>Auto</b> , <b>Motion detection</b> is disabled.
	AF area mode (📖 54)	When <b>Subject tracking</b> is selected, <b>Motion detection</b> is disabled.
Shutter sound	Continuous (📖 54)	When a setting other than <b>Single</b> is selected, the shutter sound is disabled.
Blink warning	Continuous (📖 54)	When a setting other than <b>Single</b> is selected, the blink warning is disabled.



# Focusing

The focus area varies depending on the shooting mode.

## Using Face Detection

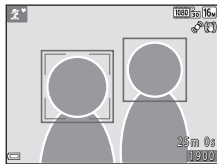

When the following shooting modes or settings are selected, the camera uses face detection to automatically focus on human faces.

-  (easy auto) mode (📖 31)
- **Portrait** or **Night portrait** in scene mode (📖 32)
- Smart portrait mode (📖 40)
- When **AF area mode** (📖 54) in  (auto) mode (📖 42) is set to **Face priority**



If the camera detects more than one face, a double border is displayed around the face that the camera focuses on, and single borders are displayed around the other faces.

If the shutter button is pressed halfway when no faces are detected:

- In  (easy auto) mode, the focus area changes depending on the scene.
- In **Portrait** and **Night portrait** scene modes, or in smart portrait mode, the camera focuses on the area in the center of the frame.
- In  (auto) mode, the camera selects the focus area containing the subject closest to the camera.

## Notes About Face Detection

- When **Autofocus mode** in the movie menu is set to **Single AF**, the focus area is not displayed even if a face is detected.
- The camera's ability to detect faces depends on a variety of factors, including the direction in which the faces are looking.
- The camera may be unable to detect faces in the following situations:
  - When faces are partially hidden by sunglasses or otherwise obstructed
  - When faces take up too much or too little of the frame

## Face Detection When Recording Movies

When **AF area mode** (📖 69) in the movie menu is set to **Face priority**, focus priority is set on faces when recording movies.

## Using Skin Softening

When the shutter is released while using one of the shooting modes listed below, the camera detects human faces and processes the image to soften facial skin tones (up to three faces).

- Smart portrait mode (📖 40)
- **Portrait** or **Night portrait** in  (easy auto) mode (📖 31)
- **Portrait** or **Night portrait** in scene mode (📖 32)

**Skin softening** can also be applied to saved images (📖 64,  11).

## Notes About Skin Softening

- It may take more time than usual to save images after shooting.
- Under some shooting conditions, the desired skin softening results may not be achieved, and skin softening may be applied to areas of the image where there are no faces.

## Using Target Finding AF

When **AF area mode** (📖 54) in 📷 (auto) mode is set to **Target finding AF**, the camera focuses in the manner described below when you press the shutter-release button halfway:

- The camera detects the main subject and focuses on it.  
When the subject is in focus, the focus area glows green. If a human face is detected, the camera automatically sets focus priority on it.
- If no main subject is detected, the camera automatically selects one or more of the nine focus areas containing the subject closest to the camera.  
When the subject is in focus, the focus areas that are in focus glow green.

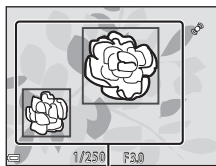

Focus areas

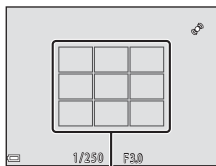

Focus areas

### ✔ Notes About Target Finding AF

- Depending on shooting conditions, the subject that the camera determines to be the main subject may vary.
- The main subject may not be detected when using certain **White balance** settings.
- The camera may not detect the main subject appropriately in the following situations:
  - When the subject is very dark or bright
  - When the main subject lacks clearly defined colors
  - When the shot is framed so that the main subject is at the edge of the monitor
  - When the main subject is composed of a repeating pattern

## Subjects Not Suitable for Autofocus

The camera may not focus as expected in the following situations. In some rare cases, the subject may not be in focus despite the fact that the focus area or the focus indicator glows green:

- Subject is very dark
- Objects of sharply differing brightness are included in the scene (e.g. the sun behind the subject makes that subject appear very dark)
- No contrast between the subject and surroundings (e.g. a portrait subject wearing a white shirt is standing in front of a white wall)
- Several objects are at different distances from the camera (e.g. the subject is inside a cage)
- Subjects with repeating patterns (window blinds, buildings with multiple rows of similarly shaped windows, etc.)
- Subject is moving rapidly

In the situations noted above, try pressing the shutter-release button halfway to refocus several times, or focus on another subject positioned at the same distance from the camera as the actual desired subject, and use focus lock (📖 61).

## Focus Lock

Focus lock shooting is recommended when the camera does not activate the focus area that contains the desired subject.

**1** Set **AF area mode** to **Center** in  (auto) mode ( 53).

**2** Position the subject in the center of the frame and press the shutter-release button halfway.

- Confirm that the focus area glows green.
- Focus and exposure are locked.

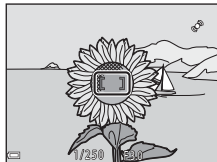

**3** Without lifting your finger, recompose the picture.

- Make sure to maintain the same distance between the camera and the subject.

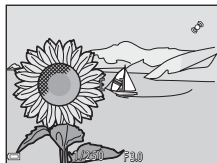

**4** Press the shutter-release button the rest of the way down to take the picture.



# Playback Features

## Playback Zoom

Moving the zoom control toward **T** (📄) in full-frame playback mode (📖 28) zooms in on the image.

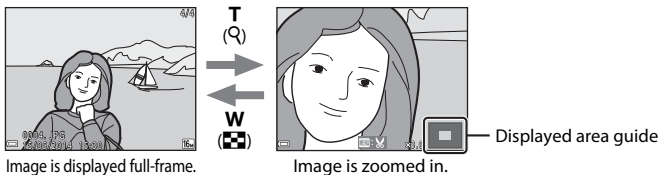

- You can change the zoom ratio by moving the zoom control toward **W** (📐) or **T** (📄).
- To view a different area of the image, press the multi selector ▲▼◀▶.
- If you are viewing an image that was captured using face detection or pet detection, the camera zooms in on the face detected at the time of shooting (except when viewing an image captured in a series). To zoom in on an area of the image where there are no faces, adjust the magnification rate and then press ▲▼◀▶.
- When a zoomed image is displayed, press the **OK** button to return to full-frame playback mode.

### Cropping Images

When a zoomed image is displayed, you can press the **MENU** button to crop the image to include only the visible portion and save it as a separate file (🔑15).

## Thumbnail Playback, Calendar Display

Moving the zoom control toward **W** (🗉) in full-frame playback mode (📖 28) displays images as thumbnails.

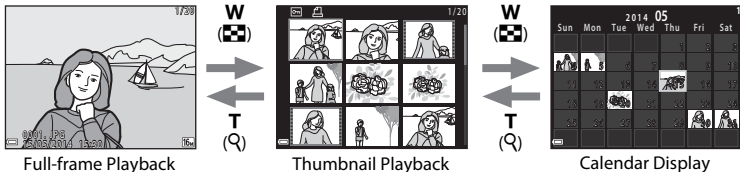

















- You can change the number of thumbnails displayed by moving the zoom control toward **W** (🗉) or **T** (📷).
- While using thumbnail playback mode, press the multi selector **▲▼◀▶** to select an image and then press the **OK** button to display that image full-frame.
- While using calendar display mode, press **▲▼◀▶** to select a date and then press the **OK** button to display the images captured on that day.

### 🗑 Notes About Calendar Display

Images captured when the camera's date is not set are treated as images captured on January 1, 2014.

## Functions That Can Be Set with the MENU Button (Playback Menu)

When viewing images in full-frame playback mode or thumbnail playback mode, you can configure the menu operations listed below by pressing the **MENU** button.

Option	Description	
Quick retouch*	Allows you to create retouched copies in which contrast and saturation have been enhanced.	 9
D-Lighting*	Allows you to create copies with enhanced brightness and contrast, brightening dark portions of an image.	 9
Red-eye correction*	Corrects the red-eye effect that appears in the eyes when shooting using the flash.	 10
Skin softening*	The camera detects human faces in images and creates a copy with softer facial skin tones.	 11
Filter effects*	Digital filter effects can be used to apply a variety of effects to images.	 12
Print order	Allows you to select which images are printed, and how many copies of each image are printed, prior to printing.	 42
Slide show	Allows you to view images in an automatic slide show.	 45
Protect	Protects selected images from accidental deletion.	 46
Rotate image	Allows you to rotate the displayed image to portrait or landscape orientation.	 48
Small picture*	Creates a small copy of images.	 14
Copy	Allows you to copy images between the internal memory and a memory card.	 49
Sequence display options	Allows you to select whether to display only the key picture for a sequence of images captured continuously or to display the sequence as individual images. <ul style="list-style-type: none"><li>When only the key picture is displayed for a sequence, press the  button to display each image in the sequence. Press the multi selector  to return to the key picture display.</li></ul>	 51
Choose key picture	Allows you to change the key picture for images captured in sequence.	 51

\* Edited images are saved as separate files. Some images may not be edited.



# Recording and Playing Back Movies

## Recording Movies

### 1 Display the shooting screen.

- Check the remaining amount of movie recording time.
- If **Photo info** in the **Monitor settings** (📖 72) in the setup menu is set to **Movie frame+auto info**, the area that will be visible in the movie can be confirmed before movie recording starts.



Movie recording time remaining

### 2 Lower the flash (📖 5)

- Recording movies while the flash is raised may cause the audio to be muffled.

### 3 Press the ● (▶📹 movie-record) button to start movie recording.

- When **AF area mode** (📖 69) in the movie menu is set to **Face priority**, focus priority is set on faces.

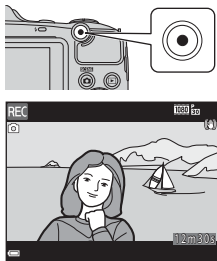

### 4 Press the ● (▶📹 movie-record) button again to end recording.

## Maximum Movie Length

Individual movie files cannot exceed 4 GB in size or 29 minutes in length, even when there is sufficient free space on the memory card for longer recording.

- The maximum movie length for a single movie is displayed on the shooting screen.
- Recording may end before either limit is reached if camera temperature becomes elevated.
- The actual movie length may vary depending on the movie content, subject movement, or type of memory card.

## Notes About Saving Images and Recording Movies

The indicator showing the number of exposures remaining or the indicator showing the maximum movie length flashes while images are being saved or while a movie is being recorded. **Do not open the battery-chamber/memory card slot cover or remove the batteries or memory card** while an indicator is flashing. Doing this could result in loss of data, or in damage to the camera or the memory card.

## Notes About Movie Recording

- Memory cards with an SD Speed Class rating of 6 or faster are recommended when recording movies (C:18). Movie recording may stop unexpectedly when memory cards with a lower Speed Class rating are used.
- When using the camera's internal memory, saving movies may take some time.
- There may be some degradation in image quality when digital zoom is used.
- The sounds of zoom control operation, zoom, autofocus lens drive movement, vibration reduction, and aperture operation when brightness changes may be recorded.
- The following phenomena may be seen in the monitor while recording movies. These phenomena are saved in the recorded movies.
  - Banding may occur in images under fluorescent, mercury-vapor, or sodium-vapor lighting.
  - Subjects that move quickly from one side of the frame to the other, such as a moving train or car, may appear skewed.
  - The entire movie image may be skewed when the camera is panned.
  - Lighting or other bright areas may leave residual images when the camera is moved.
- Depending on the distance to the subject or the amount of zoom applied, subjects with repeating patterns (fabrics, lattice windows, etc.) may have colored stripes (interference patterns, moire, etc.) in them during movie recording and playback. This occurs when the pattern in the subject and the layout of the image sensor interfere with each other; it is not a malfunction.

## ✓ Notes About Vibration Reduction When Recording Movies

- When **Movie VR** in the movie menu (📖 69) is set to **On (hybrid)**, the angle of view (i.e., the area visible in the frame) becomes narrower when recording movies.
- When using a tripod to stabilize the camera during shooting, set **Movie VR** to **Off** to prevent potential errors caused by this function.

## ✓ Camera Temperature

- The camera may become warm when shooting movies for an extended period of time or when the camera is used in a hot area.
- If the inside of the camera becomes extremely hot when recording movies, the camera will automatically stop recording.  
The amount of time remaining until the camera stops recording (🕒 10s) is displayed.  
After the camera stops recording, it turns itself off.  
Leave the camera off until the inside of the camera has cooled.

## ✓ Notes About Autofocus



Autofocus may not perform as expected (📖 60). Should this occur, try the following:

1. Set **AF area mode** in the movie menu to **Center** before starting movie recording.
2. Set **Autofocus mode** in the movie menu to **Single AF** (default setting).
3. Frame another subject—positioned at the same distance from the camera as the intended subject—in the center of the frame, press the ● (📹 movie-record) button to start recording, and then modify the composition.

## Saving Still Images While Recording Movies





If the shutter-release button is pressed all the way while recording a movie, one frame is saved as a still image (JPEG).

Movie recording continues while the still image is being saved.

-  is displayed in the monitor. When  is displayed, a still image cannot be saved.
- The image size of the still image that is saved varies depending on the **Movie options** setting.



### Notes About Saving Still Images While Recording Movies







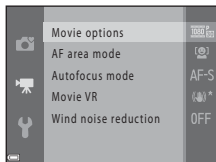

- Still images cannot be saved while recording a movie in the following situations:
  - When there is less than five seconds of movie recording time remaining
  - When **Movie options** ( 69) is set to  **1080/60i**,  **1080/50i**,  **480/30p**,  **480/25p**, or HS movie
- The sound of the shutter-release button pressed during recording may be heard in the recorded movie.
- If the camera moves when the shutter-release button is pressed, the image may be blurred.

## Functions That Can Be Set with the MENU Button (Movie Menu)

Enter shooting mode → MENU button →  menu icon →  button

The settings of the menu options listed below can be configured.



Option	Description	
Movie options	Select the movie type. Select normal speed to record movies at normal speed, or HS (high speed) to record movies that play in slow or fast motion. • Default setting:  <b>1080/30p</b> or  <b>1080/25p</b>	 52
AF area mode	Use this option to determine how the camera selects the focus area when recording movies. • Default setting: <b>Face priority</b>	 55
Autofocus mode	Select either <b>Single AF</b> , which locks focus when movie recording begins, or <b>Full-time AF</b> , which continues focusing during movie recording. • Default setting: <b>Single AF</b>	 55
Movie VR	Select the vibration reduction setting used when recording movies. • Default setting: <b>On (hybrid)</b>	 56
Wind noise reduction	Set whether or not to reduce wind noise during movie recording. • Default setting: <b>Off</b>	 56

## Playing Back Movies

Press the  button to enter playback mode.

Movies are indicated by the movie options icon ( 69).

Press the  button to play back movies.

- To adjust the volume, move the zoom control ( 1).

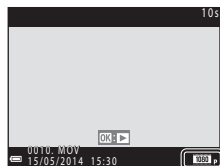

Movie options

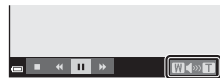

Volume indicator

## Functions Available During Playback















Playback controls are displayed in the monitor.

The operations listed below can be performed by using the multi selector  to select a control and then pressing the





 button.



Paused

Function	Icon	Description
Rewind		Hold down the  button to rewind the movie.
Advance		Hold down the  button to advance the movie.
Pause		Pause playback. The operations listed below can be performed while paused.
		 Rewind the movie one frame. Hold down the  button for continuous rewinding.
		 Advance the movie one frame. Hold down the  button for continuous advancing.
		 Extract the desired portion of a movie and save it as a separate file (  25).
		 One frame from a recorded movie can be extracted and saved as a still image (  26).
		 Resume playback.
End		Return to full-frame playback mode.

## Deleting movies

To delete a movie, select the desired movie in full-frame playback mode ( 28) or thumbnail playback mode ( 63) and press the  button ( 29).









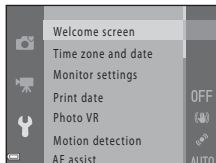

# General Camera Setup

## Functions That Can Be Set with the MENU Button (Setup Menu)









Press the MENU button →  (setup) menu icon →  button

The settings of the menu options listed below can be configured.



Option	Description	
Welcome screen	Allows you to select whether or not the welcome screen is displayed when the camera is turned on.	 57
Time zone and date	Allows you to set the camera clock.	 58
Monitor settings	Allows you to adjust photo information display, post-shooting image review, and monitor brightness settings.	 60
Print date	Allows you to imprint the shooting date and time on images.	 62
Photo VR	Allows you to select the vibration reduction setting used when shooting still images.	 63
Motion detection	Allows you to set whether or not the camera automatically increases the shutter speed to reduce blurring caused by camera shake if motion is detected when shooting still images.	 64
AF assist	Allows you to enable or disable the AF-assist illuminator.	 65
Sound settings	Allows you to adjust sound settings.	 65
Auto off	Allows you to set the amount of time that passes before the monitor turns off to save power.	 66



Option	Description	
<b>Format memory/ Format card</b>	Allows you to format the internal memory or the memory card.	 67
<b>Language</b>	Allows you to change the camera's display language.	 68
<b>TV settings</b>	Allows you to adjust TV-connection settings.	 68
<b>Blink warning</b>	Allows you to set whether or not closed eyes are detected when taking images of people using face detection.	 69
<b>Eye-Fi upload</b>	Allows you to set whether or not to enable the function for sending images to a computer using a commercially available Eye-Fi card.	 70
<b>Reset all</b>	Allows you to reset the camera's settings to their default values.	 71
<b>Battery type</b>	Change this setting to match the type of batteries that are inserted in the camera.	 72
<b>Firmware version</b>	View the current camera firmware version.	 72

# Connecting the Camera to a TV, Computer, or Printer

## Connection Methods

You can enhance your enjoyment of images and movies by connecting the camera to a TV, computer, or printer.

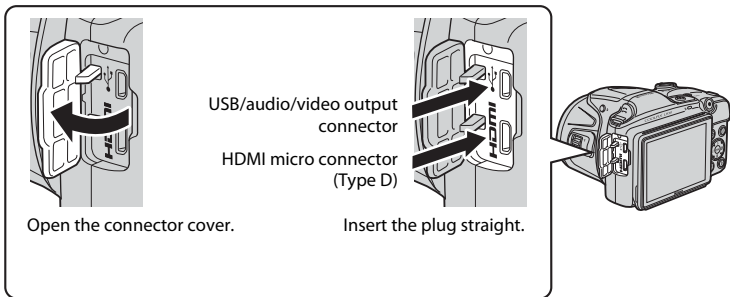

- Before connecting the camera to an external device, make sure the remaining battery level is sufficient and turn the camera off. Before disconnecting, make sure to turn the camera off.
- If the AC Adapter EH-67 (available separately) is used, this camera can be powered from an electrical outlet. Do not use any other make or model of AC adapter as it may cause the camera to heat up or malfunction.
- For information about the connection methods and subsequent operations, refer to the documentation included with the device in addition to this document.

**Viewing images on a TV** 16

Images and movies captured with the camera can be viewed on a TV. Connection method: Connect the video and audio plugs of the optional audio video cable to the TV's input jacks. Alternatively, connect a commercially available HDMI cable to the TV's HDMI input jack.

**Viewing and organizing images on a computer** 76

You can transfer images to a computer to perform simple retouching and manage image data. Connection method: Connect the camera to the computer's USB port with the included USB cable.

- Before connecting to a computer, install ViewNX 2 on the computer ( 76).

**Printing images without using a computer** 19

If you connect the camera to a PictBridge-compatible printer, you can print images without using a computer. Connection method: Connect the camera directly to the printer's USB port with the USB cable.

## Using ViewNX 2

Install ViewNX 2 to upload, view, edit, and share photos and movies.

### Your Imaging Toolbox

ViewNX 2™



### Installing ViewNX 2

An Internet connection is required.

For system requirements and other information, see the Nikon website for your region.

#### 1 Download the ViewNX 2 installer.

Start the computer and download the installer from:

*<http://nikonimglib.com/nvnx/>*

#### 2 Double-click the downloaded file.

#### 3 Follow the on-screen instructions.

#### 4 Exit the installer.

Click **Yes** (Windows) or **OK** (Mac).

# Transferring Images to the Computer

## 1 Choose how images will be copied to the computer.

Choose one of the following methods:

- **Direct USB connection:** Turn the camera off and ensure that the memory card is inserted in the camera. Connect the camera to the computer using the USB cable. Turn the camera on. To transfer images that are saved in the camera's internal memory, remove the memory card from the camera before connecting it to the computer.

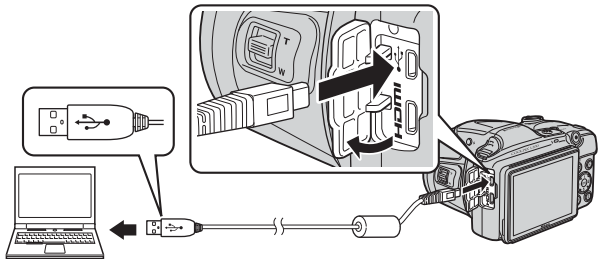

- **SD card slot:** If your computer is equipped with an SD card slot, the card can be inserted directly in the slot.
- **SD card reader:** Connect a card reader (available separately from third-party suppliers) to the computer and insert the memory card.

If a message is displayed prompting you to choose a program, select Nikon Transfer 2.

- **When using Windows 7**

If the dialog shown at right is displayed, follow the steps below to select Nikon Transfer 2.

- 1 Under **Import pictures and videos**, click **Change program**. A program selection dialog will be displayed; select **Import File using Nikon Transfer 2** and click **OK**.
- 2 Double-click **Import File**.



If the memory card contains a large number of images, it may take a while for Nikon Transfer 2 to start. Wait until Nikon Transfer 2 starts.

## ✓ Connecting the USB Cable

The connection may not be recognized if the camera is connected to the computer via a USB hub.

## 2 Transfer images to the computer.

- Click **Start Transfer**.

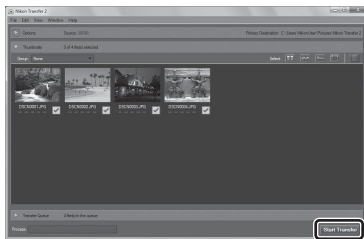

- At default settings, all the images on the memory card will be copied to the computer.

### 3 Terminate the connection.

- If the camera is connected to the computer, turn the camera off and disconnect the USB cable. If you are using a card reader or card slot, choose the appropriate option in the computer operating system to eject the removable disk corresponding to the memory card, and then remove the card from the card reader or card slot.

## Viewing Images

### Start ViewNX 2.

- Images are displayed in ViewNX 2 when transfer is complete.
- Consult online help for more information on using ViewNX 2.

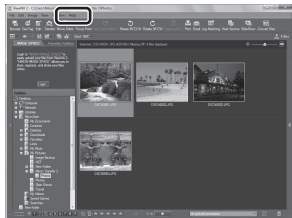

### Starting ViewNX 2 Manually

- **Windows:** Double-click the **ViewNX 2** shortcut on the desktop.
- **Mac:** Click the **ViewNX 2** icon in the Dock.



A series of ten horizontal dashed lines spanning the width of the page, intended for handwriting practice.





# Reference Section

The Reference Section provides detailed information and hints about using the camera.

## Shooting

---

Using Easy Panorama (Shooting and Playback) .....  2

## Playback

---

Viewing and Deleting Images Captured Continuously (Sequence) ...  6

Editing Still Images .....  8



Connecting the Camera to a TV (Viewing Images on a TV) .....  16

Connecting the Camera to a Printer (Direct Print) .....  18

Editing Movies .....  25

## Menu

---

The Shooting Menu (for  (Auto) Mode) .....  27

The Smart Portrait Menu .....  40

The Playback Menu .....  42

The Movie Menu .....  52

The Setup Menu .....  57

## Additional Information

---









Error Messages .....  73

File Names .....  77



Optional Accessories .....  78



# Using Easy Panorama (Shooting and Playback)

## Shooting with Easy Panorama

Enter shooting mode →  (shooting mode) button →  (second icon from the top\*)  
→     →  (easy panorama) →  button

\* The icon of the last scene selected is displayed.

**1** Select  **Normal (180°)** or  **Wide (360°)** as the shooting range and press the  button.

- When the camera is readied in the horizontal position, the image size (width × height) is as follows.
  -  **Normal (180°)**: 4800 × 920 when moved horizontally, 1536 × 4800 when moved vertically
  -  **Wide (360°)**: 9600 × 920 when moved horizontally, 1536 × 9600 when moved vertically

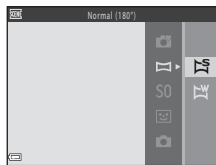

**2** Frame the first edge of the panorama scene, and then press the shutter-release button halfway to focus.

- The zoom position is fixed at wide-angle.
- The camera focuses on the area in the center of the frame.

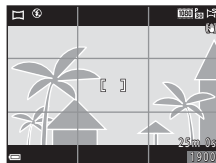

- 3** Press the shutter-release button all the way, and then remove your finger from the shutter-release button.

- △▽◁▷ are displayed to indicate the direction of camera movement.



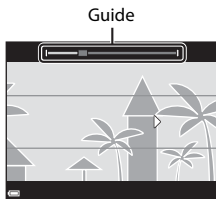

- 4** Move the camera in one of the four directions until the guide indicator reaches the end.

- When the camera detects which direction it is moving in, shooting begins.

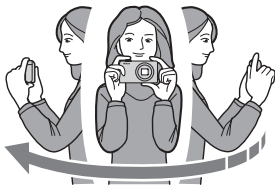

### Example of camera movement



- Using your body as the axis of rotation, move the camera slowly in an arc, in the direction of the marking (△▽◁▷).
- Shooting stops if the guide does not reach the edge within about 15 seconds (when  **Normal (180°)** is selected) or within about 30 seconds (when  **Wide (360°)** is selected) after shooting starts.

## **Notes About Easy Panorama Shooting**

- The range of the image seen in the saved image is narrower than that seen in the monitor at the time of shooting.
- If the camera is moved too quickly or shaken too much, or if the subject is too uniform (e.g. walls or darkness), an error may occur.
- If shooting is stopped before the camera reaches the half-way point in the panorama range, a panorama image is not saved.
- If more than half of the panorama range is captured but shooting ends before reaching the edge of the range, the range not captured is recorded and displayed in gray.

## Viewing Images Captured with Easy Panorama

Switch to playback mode (📖 28), display an image captured using easy panorama in full-frame playback mode, and then press the **OK** button to scroll the image in the direction that was used when shooting.

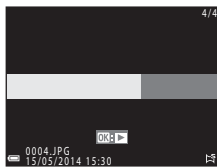

Playback controls are displayed in the monitor during playback. Use the multi selector **◀▶** to select a control, and then press the **OK** button to perform the following operations.

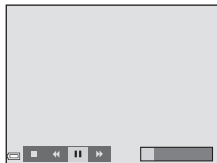

Function	Icon	Description
Rewind	◀◀	Hold down the <b>OK</b> button to scroll backward quickly.
Advance	▶▶	Hold down the <b>OK</b> button to scroll forward quickly.
Pause		Pause playback. The operations listed below can be performed while paused.
		◀◀ Hold down the <b>OK</b> button to rewind.
		▶▶ Hold down the <b>OK</b> button to scroll.
	▶	Resume automatic scrolling.
End	■	Switch to full-frame playback mode.

### 👍 Notes About Scroll Playback

This camera may not be able to scroll the playback of, or zoom in on, easy panorama images captured with another make or model of digital camera.

# Viewing and Deleting Images Captured Continuously (Sequence)

## Viewing Images in a Sequence

Images captured continuously are saved as a sequence.

The first image of a sequence is used as the key picture to represent the sequence when displayed in full-frame playback mode or thumbnail playback mode (default setting).

To display each image in the sequence individually, press the **OK** button.

After pressing the **OK** button, the operations listed below are available.

- To display the previous or next image, press the multi selector **◀▶**.
- To display images that are not included in the sequence, press **▲** to return to the key picture display.
- To display images in a sequence as thumbnails, or to play them back in a slide show, set **Sequence display options** to **Individual pictures** in the playback menu (**651**).



### **✓** Sequence Display Options

Images captured continuously with cameras other than this camera cannot be displayed as a sequence.

### **📄** Playback Menu Options Available When Using Sequence

- When images in a sequence are displayed in full-frame playback mode, press the **MENU** button to select functions in playback menu (**64**).
- If you press the **MENU** button when a key picture is displayed, the following settings can be applied to all images in the sequence:
  - Print order, Protect, Copy

## Deleting Images in a Sequence

When the  button is pressed for images in a sequence, the images that are deleted vary depending on how the sequences are displayed.

- When the key picture is displayed:
  - **Current image:** All images in the displayed sequence are deleted.
  - **Erase selected images:** When a key picture is selected on the erase selected images screen ( 30), all images in that sequence are deleted.
  - **All images:** All images in the internal memory or on the memory card are deleted.
- When images in a sequence are displayed in full-frame playback mode:
  - **Current image:** The image currently displayed is deleted.
  - **Erase selected images:** Images that are selected in the sequence are deleted.
  - **Entire sequence:** All images in the displayed sequence are deleted.

# Editing Still Images

## Before Editing Images

You can easily edit images on this camera. Edited copies are saved as separate files. Edited copies are saved with the same shooting date and time as the original.





### Restrictions on Image Editing

An image can be edited up to ten times.



## Quick Retouch: Enhancing Contrast and Saturation



Press the  button (playback mode) → select an image → MENU button → Quick retouch →  button

Use the multi selector ▲▼ to select the amount of effect applied and press the  button.

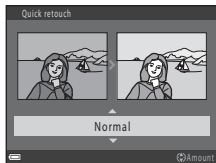
- The edited version is displayed on the right.
- To exit without saving the copy, press ◀.



## D-Lighting: Enhancing Brightness and Contrast



Press the  button (playback mode) → select an image → MENU button → D-Lighting →  button

Use the multi selector ▲▼ to select **OK** and press the  button.

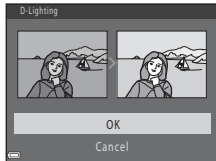
- The edited version is displayed on the right.
- To exit without saving the copy, select **Cancel** and press the  button.



## Red-eye Correction: Correcting Red Eyes Caused by Using the Flash

Press the  button (playback mode) → select an image → MENU button → Red-eye correction →  button

Preview the result and press the  button.

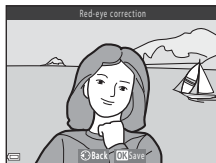

- To exit without saving the copy, press the multi selector .





### Notes About Red-eye Correction

- Images in which the camera cannot detect red eyes cannot be corrected.
- For pets (dogs or cats), red-eye correction is applied to eyes regardless of their color.
- Depending on the image, the function may not perform as expected.
- Red-eye correction may be applied to areas not affected by red-eye in rare cases.

# Skin Softening: Softening Skin Tones



Press the  button (playback mode) → select an image → MENU button → Skin softening →  button

**1** Use the multi selector ▲▼ to select the amount of effect applied and press the  button.

- The confirmation dialog is displayed with the face to which the effect was applied enlarged in the monitor.
- To exit without saving the copy, press .



**2** Preview the result and press the  button.



- Skin tones of up to 12 faces, in the order of that closest to the center of the frame, are softened.
- If more than one face was processed, use   to display a different face.
- Press the MENU button to adjust the amount of effect applied. The monitor display returns to that shown in step 1.



## Notes About Skin Softening



- Skin softening cannot be applied if no faces are detected in the image.
- Depending upon the direction in which faces are looking, or the brightness of faces, the camera may be unable to accurately detect faces, or the skin softening function may not perform as expected.

## Filter Effects: Applying Digital Filter Effects

Press the  button (playback mode) → select an image → MENU button → Filter effects →  button

Option	Description
Pop and Super vivid	Mainly enhances the color saturation.
Painting, High key, Toy camera effect 1, Toy camera effect 2, Low key, and Cross process	Mainly adjusts hue and creates a different look for the image.
Soft, Soft portrait*, Fisheye, Cross screen, and Miniature effect	Processes images with a variety of effects.
High-contrast monochrome, Sepia, Cyanotype, and Selective color	Turns multicolor images into single color images. Selective color transforms all colors, except a specified color, to black and white.

\* When the image size is **640×480** or smaller, **Soft portrait** cannot be applied.

**1** Use the multi selector   to select the desired effect and press the  button.

- When any setting other than **Cross process**, **Soft**, or **Selective color** is selected, proceed to step 3.

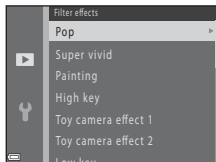

## 2 Adjust the effect and press the **OK** button.

- When using **Cross process** or **Selective color**: Use ▲▼ to select the color.
- When using **Soft**: Use ▲▼ to select the range of the effect.
- Press ◀ to return to the **Filter effects** selection screen without making any changes.





Example: **Cross process**



## 3 Preview the result and press the **OK** button.

- An edited copy is created.
- To exit without saving the copy, press ◀





## Small Picture: Reducing the Size of an Image

Press the  button (playback mode) → select an image → MENU button → Small picture →  button

**1** Use the multi selector   to select the desired copy size and press the  button.

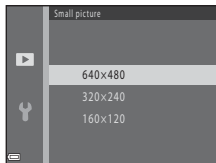
- For images taken at an image mode setting of  **4608×2592**, only **640×360** is displayed.



**2** Select **Yes** and press the  button.

- An edited copy is created (compression ratio of approximately 1:8).

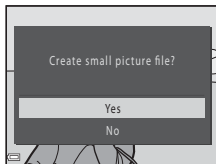

### **Notes About Small Picture**

Images with an aspect ratio of 1:1 cannot be edited.

# Crop: Creating a Cropped Copy

**1** Move the zoom control to enlarge the image (📖 62).

**2** Refine copy composition and press the **MENU** button.

- Move the zoom control toward **T** (📏) or **W** (📐) to adjust the zoom ratio. Set a zoom ratio at which **MENU**:🗑️ is displayed.
- Use the multi selector ▲▼◀▶ to scroll the image so that only the portion to be copied is visible in the monitor.



**3** Select **Yes** and press the **OK** button.

- An edited copy is created.



## Image Size

When the image size of the cropped copy is 320 x 240 or smaller, the image is displayed at a smaller size during playback.

## Cropping the Image in Its Current "Tall" Orientation

Use the **Rotate image** option (🔄48) to rotate the image so that it is displayed in landscape orientation. After cropping the image, rotate the cropped image back to "tall" orientation.

# Connecting the Camera to a TV (Viewing Images on a TV)

## 1 Turn off the camera and connect it to the TV.

- Make sure that the plugs are properly oriented. Do not insert or remove the plugs at an angle when connecting or disconnecting them.

### When using the audio/video cable

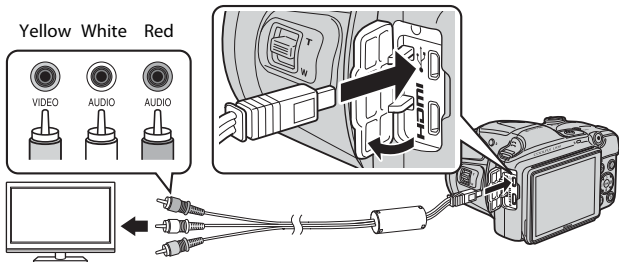

### When using a commercially available HDMI cable

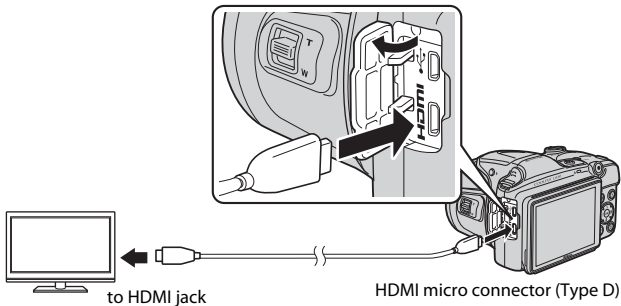



## 2 Set the TV's input to external video input.

- See the documentation provided with your TV for details.

## 3 Hold down the button to turn on the camera.

- Images are displayed on the TV.
- The camera monitor does not turn on.

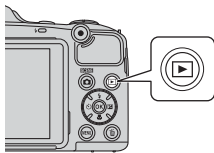

### If Images Are Not Displayed on the TV

Make sure that **TV settings** (68) in the setup menu conforms to the standard used by your TV.

### Using a TV Remote Control (HDMI Device Control)

The remote control of an HDMI-CEC-compatible TV can be used to select images, start and pause movie playback, switch between full-screen playback mode and four-image thumbnail display, etc.

- Set the **HDMI device control** setting (68) of **TV settings** to **On** (default setting) and then connect the camera and TV using an HDMI cable.
- Aim the remote control at the TV when operating it.

## Connecting the Camera to a Printer (Direct Print)

Users of PictBridge-compatible printers can connect the camera directly to the printer and print images without using a computer.

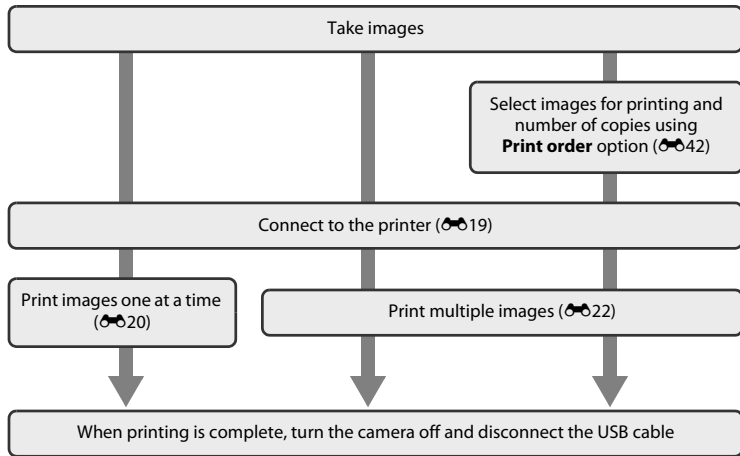

# Connecting the Camera to a Printer

- 1 Turn off the camera.
- 2 Turn on the printer.
  - Check printer settings.
- 3 Connect the camera to the printer using the USB cable.
  - Make sure that the plugs are properly oriented. Do not insert or remove the plugs at an angle when connecting or disconnecting them.

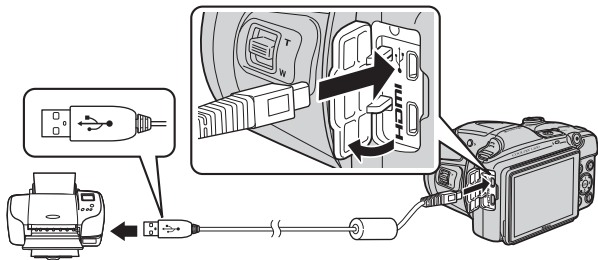

- 4 Turn on the camera.
  - The **PictBridge** startup screen (①) is displayed in the camera monitor, followed by the **Print selection** screen (②).

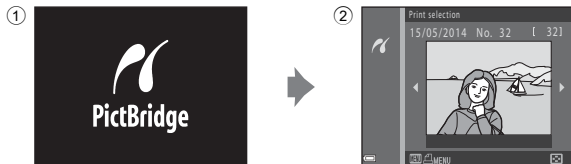

# Printing Individual Images

**1** Use the multi selector to select the desired image and press the **OK** button.

- Move the zoom control toward **W** (📐) to switch to thumbnail playback or **T** (📺) to switch to full-frame playback.



**2** Use **▲▼** to select **Copies** and press the **OK** button.

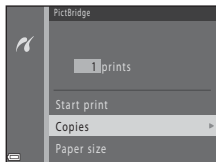

**3** Select the desired number of copies (up to nine) and press the **OK** button.



**4** Select **Paper size** and press the **OK** button.

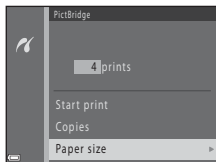

## 5 Select the desired paper size and press the **OK** button.

- To apply the paper size setting configured on the printer, select **Default** as the paper size option.
- The paper size options available on the camera vary depending on the printer that you use.

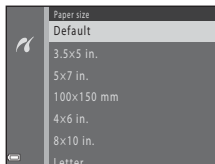

## 6 Select **Start print** and press the **OK** button.

- Printing starts.
- To cancel printing, press the **OK** button.

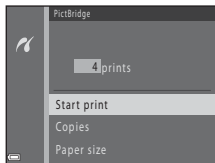

# Printing Multiple Images

- 1 When the **Print selection** screen is displayed, press the **MENU** button.



- 2 Use the multi selector **▲▼** to select **Paper size** and press the **OK** button.

- To exit the print menu, press the **MENU** button.

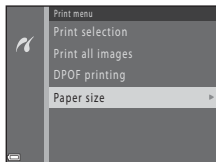

- 3 Select the desired paper size and press the **OK** button.

- To apply the paper size setting configured on the printer, select **Default** in the paper size option.
- The paper size options available on the camera vary depending on the printer that you use.

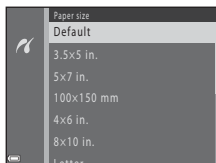

- 4 Select **Print selection**, **Print all images**, or **DPOF printing** and press the **OK** button.

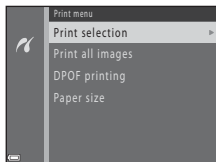

## Print selection

Select images (up to 99) and the number of copies (up to nine) of each.

- Use the multi selector ◀▶ to select images, and use ▲▼ to specify the number of copies to be printed.
- Images selected for printing are indicated by 🖨️ and the numeral indicating the number of copies to be printed. If no copies have been specified for images, the selection is canceled.
- Move the zoom control toward **T** (🔍) to switch to full-frame playback or **W** (🖼️) to switch to thumbnail playback.
- Press the **OK** button when setting is complete.
- When the screen shown on the right is displayed, select **Start print** and press the **OK** button to start printing.

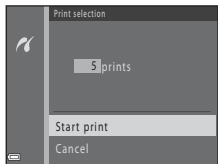

## Print all images

One copy each of all images saved in the internal memory, or on the memory card, is printed.

- When the screen shown on the right is displayed, select **Start print** and press the **OK** button to start printing.

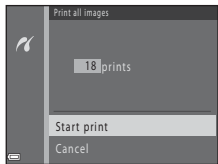

## DPOF printing

Print images for which a print order was created using the **Print order** option (🔑42).

- When the screen shown on the right is displayed, select **Start print** and press the **OK** button to start printing.

To view the current print order, select **View images** and press the **OK** button. To print images, press the **OK** button again.

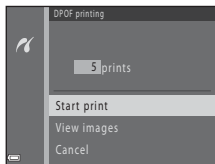

### More Information

See "Printing Images of Size 1:1" (🔑28) for more information.



# Editing Movies

## Extracting Only the Desired Portions of a Movie

The desired portions of a recorded movie can be saved as a separate file.

**1** Play back the desired movie and pause at the start point of the portion that is to be extracted (📖 71).

**2** Use the multi selector ◀▶ to select the  control, and then press the **OK** button.

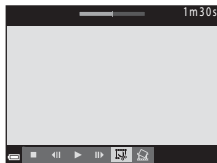

**3** Use ▲▼ to select the  control (choose start point).

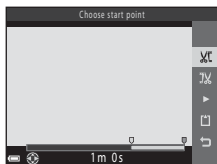

- Use ◀▶ to move the start point.
- To cancel editing, select ↵ (return), and press the **OK** button.

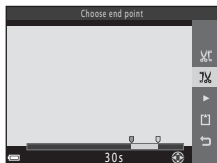

**4** Use ▲▼ to select the  control (choose end point).

- Use ◀▶ to move the end point.
- To preview the specified portion, select ▶ and then press the **OK** button. Press the **OK** button again to stop previewing.



- 5 Use ▲▼ to select  (Save) and press the  button.

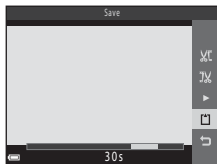

- Follow the instructions on the screen to save the movie.







## Notes About Movie Editing



- A movie that was created by editing cannot be trimmed again.
- The actual trimmed portion of a movie may differ slightly from the portion selected using the start and end points.
- Movies cannot be trimmed so that they are less than two seconds long.

## Saving a Frame from a Movie as a Still Image

A frame from a recorded movie can be extracted and saved as a still image (except for movies recorded with  **1080/60i** or  **1080/50i**).

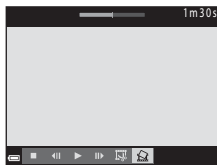
- Pause movie playback so that the frame to be extracted is displayed ( 71).
- Use the multi selector  to select the  control, and then press the  button.



- When the confirmation dialog is displayed, select **Yes** and press the  button to save.
- The image size of the still image that is saved varies depending on the type (image size;  52) of the original movie.

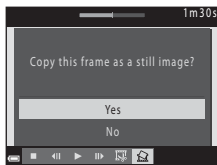









# The Shooting Menu (for (Auto) Mode)

## Image Mode Settings (Image Size and Quality)

Enter shooting mode → MENU button → Shooting menu → Image mode →  button

Select the combination of image size and compression ratio that is used when saving images. The higher the image mode setting, the larger the size at which images can be printed, and the lower the compression ratio, the higher the quality of the images, but the number of images that can be saved is reduced.

Option*	Compression ratio	Aspect ratio (horizontal to vertical)
 4608×3456 ★	Approx. 1:4	4:3
 4608×3456 (default setting)	Approx. 1:8	4:3
 3264×2448	Approx. 1:8	4:3
 2272×1704	Approx. 1:8	4:3
 1600×1200	Approx. 1:8	4:3
 640×480	Approx. 1:8	4:3
 4608×2592	Approx. 1:8	16:9
 3456×3456	Approx. 1:8	1:1

\* The total number of pixels captured, and the number of pixels captured horizontally and vertically.  
Example:  **4608×3456** = approx. 16 megapixels, 4608 × 3456 pixels



### Notes About Image Mode

- The image mode setting can also be changed in shooting modes other than  (auto) mode. The changed setting is also applied to other shooting modes.
- The setting may not be changed when using certain settings of other functions.



### Number of Images That Can Be Saved

- The approximate number of images that can be saved can be checked in the monitor when shooting ( 20).
- Note that due to JPEG compression, the number of images that can be saved may vary greatly depending on the image content, even when using memory cards with the same capacity and the same image mode setting. In addition, the number of images that can be saved may vary depending on the make of the memory card.
- If the number of exposures remaining is 10,000 or more, the number of exposures remaining display shows “9999”.



### Printing Images of Size 1:1







Change the printer setting to “Border.” The images may not be printed in 1:1 ratio depending on the printer.

## White Balance (Adjusting Hue)

Select  (auto) mode → MENU button → White balance →  button

Adjust white balance to suit the light source or weather conditions in order to make the colors in images match what you see with your eyes.

- Use **Auto** under most conditions. Change the setting when you want to adjust the hue of the image you are taking.

Option	Description
<b>AUTO</b> Auto (default setting)	White balance is automatically adjusted to suit lighting conditions.
<b>PRE</b> Preset manual	Use when the desired result is not achieved with <b>Auto</b> , <b>Incandescent</b> , etc. (  30).
 Daylight	White balance adjusted for direct sunlight.
 Incandescent	Use under incandescent lighting.
 Fluorescent	Use under fluorescent lighting.
 Cloudy	Use when taking images under overcast skies.
 Flash	Use with the flash.

### Notes About White Balance

- Lower the flash when white balance is set to any setting other than **Auto** and **Flash** ( 5).
- The setting may not be changed when using certain settings of other functions.

## Using Preset Manual

Use the procedure below to measure the white balance value under the lighting used during shooting.

**1** Place a white or gray reference object under the lighting that will be used during shooting.

**2** Use the multi selector ▲▼ to select **Preset manual** in the **White balance** menu, and press the **OK** button.

- The camera zooms in to the position for measuring white balance.

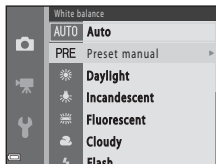

**3** Select **Measure**.

- To apply the last measured value, select **Cancel** and press the **OK** button.

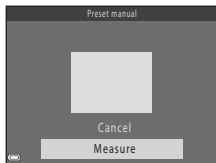

**4** Frame the reference object in the measuring window.

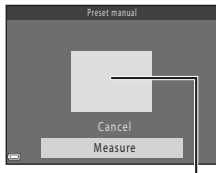

Measuring window

---



## 5 Press the button to measure the value.









- The shutter is released and measurement is complete. No image is saved.

### **Notes About Preset Manual**

A value for flash lighting cannot be measured with **Preset manual**. When shooting using the flash, set **White balance** to **Auto** or **Flash**.

# Continuous Shooting

Select  (auto) mode → MENU button → Continuous → 

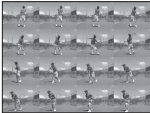

Option	Description
 Single (default setting)	One image is taken each time the shutter-release button is pressed.
 Continuous H	While the shutter-release button is held all the way down, images are captured continuously. <ul style="list-style-type: none"><li>The frame rate for continuous shooting is about 6.7 fps and the maximum number of continuous shots is about 5 (when image mode is set to  <b>4608x3456</b>).</li></ul>
 Continuous L	While the shutter-release button is held all the way down, images are captured continuously. <ul style="list-style-type: none"><li>The frame rate for continuous shooting is about 2.1 fps and the maximum number of continuous shots is about 33 (when image mode is set to  <b>4608x3456</b>).</li></ul>
 120 Continuous H: 120 fps	Each time the shutter-release button is pressed all the way, images are captured at a high speed rate. <ul style="list-style-type: none"><li>The frame rate for continuous shooting is about 120 fps and the maximum number of continuous shots is 50.</li><li><b>Image mode</b> is fixed at <b>VGA</b> (image size: 640 × 480 pixels).</li></ul>
 60 Continuous H: 60 fps	Each time the shutter-release button is pressed all the way, images are captured at a high speed rate. <ul style="list-style-type: none"><li>The frame rate for continuous shooting is about 60 fps and the maximum number of continuous shots is 25.</li><li><b>Image mode</b> is fixed at <b>1M</b> (image size: 1280 × 960 pixels).</li></ul>
<b>BSS</b> BSS (Best Shot Selector)	While the shutter-release button is held all the way down, the camera captures a series of up to ten images and automatically saves the sharpest image. Use when shooting a stationary subject in a place where flash photography is prohibited and camera shake is likely to occur.
 Multi-shot 16	Each time the shutter-release button is pressed all the way down, the camera captures a series of 16 images and saves it as a single image. <ul style="list-style-type: none"><li>The frame rate for continuous shooting is about 30 fps.</li><li><b>Image mode</b> is fixed at <b>5M</b> (image size: 2560 × 1920 pixels).</li><li>Digital zoom cannot be used.</li></ul> 



## Notes About Continuous Shooting

- When a setting other than **Single** is selected, the flash cannot be used. Focus, exposure, and white balance are fixed at the values determined with the first image in each series.
- It may take some time to save the images after shooting.
- When ISO sensitivity increases, noise may appear in captured images.
- The frame rate for continuous shooting may vary depending upon the current image mode setting, the memory card used, or shooting condition.
- When using **Continuous H: 120 fps**, **Continuous H: 60 fps**, or **Multi-shot 16**, banding or variance in brightness or hue may occur in images that were captured under lighting that flickers at high speeds, such as fluorescent, mercury-vapor, or sodium-vapor lighting.
- When ISO sensitivity is 1600 or 3200, the rate at which images are captured continuously may decrease.
- The setting may not be changed when using certain settings of other functions.

# ISO Sensitivity

Select  (auto) mode → MENU button → ISO sensitivity → 

Higher ISO sensitivity allows darker subjects to be captured. Additionally, even with subjects of similar brightness, images can be taken at faster shutter speeds, and blurring caused by camera shake and subject movement can be reduced.

- When higher ISO sensitivity is set, images may contain noise.

Option	Description
<b>AUTO</b> Auto (default setting)	Sensitivity is automatically selected from the range of ISO 125 to 1600.
<b>ISO AUTO</b> Fixed range auto	Select the range in which the camera automatically adjusts ISO sensitivity, from <b>ISO 125-400</b> or <b>ISO 125-800</b> .
125, 200, 400, 800, 1600, 3200	Sensitivity is locked at the specified value.



## Notes About ISO Sensitivity

The setting may not be changed when using certain settings of other functions.





## ISO Sensitivity Display on the Shooting Screen

- When **Auto** is selected, **ISO** is displayed if the ISO sensitivity automatically increases.
- When **Fixed range auto** is selected, the maximum value for ISO sensitivity is displayed.

## Color Options

Select  (auto) mode → MENU button → Color options →  button

Make colors more vivid or save images in monochrome.

Option	Description
 Standard color (default setting)	Use for images exhibiting natural color.
 Vivid color	Use to achieve a vivid, “photoprint” effect.
 Black-and-white	Save images in black-and-white.
 Sepia	Save images in sepia tones.
 Cyanotype	Save images in cyan-blue monochrome.

### Notes About Color Options

The setting may not be changed when using certain settings of other functions.

## AF Area Mode

Select  (auto) mode → MENU button → AF area mode → 

Use this option to determine how the camera selects the focus area for autofocus when shooting still images.

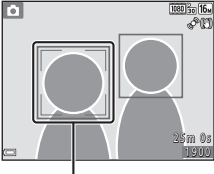
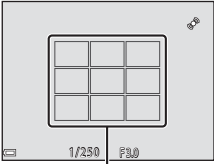
Option	Description
 Face priority	<p>When the camera detects a human face, it focuses on that face. See "Using Face Detection" (📖 57) for more information.</p>  <p>Focus area</p> <p>When framing a composition with no human subjects or detected faces, the camera automatically selects one or more of the nine focus areas containing the subject closest to the camera when the shutter-release button is pressed halfway.</p>  <p>Focus areas</p>

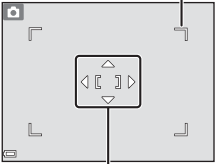
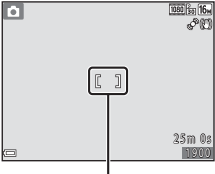
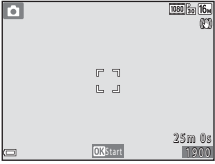

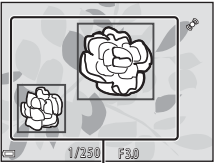

Option	Description	
<p>[<b>⏏</b>] Manual</p>	<p>Use the multi selector <b>▲▼◀▶</b> to move the focus area to where you want to focus.</p> <ul style="list-style-type: none"> <li>To use the multi selector to configure the flash mode or other settings, press the <b>OK</b> button. To return to moving the focus area, press the <b>OK</b> button again.</li> </ul>	<p>Scope of movable focus area</p>  <p>Focus area</p>
<p>[<b>■</b>] Center</p>	<p>The camera focuses on the subject in the center of the frame.</p>	 <p>Focus area</p>
<p>[<b>👁</b>] Subject tracking</p>	<p>Use this function to take images of moving subjects. Register the subject on which the camera focuses. The focus area automatically moves to track the subject.</p> <p>See “Using Subject Tracking” (p.39) for more information.</p>	

Option	Description
<p> Target finding AF (default setting)</p>	<p>When the camera detects the main subject, it focuses on that subject. See “Using Target Finding AF” (📖 59).</p>  <p style="text-align: center;">Focus areas</p>



### Notes About AF Area Mode

- When digital zoom is in effect, the camera focuses on the area in the center of the frame regardless of the **AF area mode** setting.
- The setting may not be changed when using certain settings of other functions.

## Using Subject Tracking

Select  (auto) mode → MENU button → AF area mode →  button →  Subject tracking →  button → MENU button

### 1 Register a subject.

- Align the subject that you want to track with the border in the center of the monitor and press the  button.
- When the subject is registered, a yellow border (focus area) is displayed around that subject and the camera begins tracking that subject.
- If the subject cannot be registered, the border glows red. Change the composition and try registering the subject again.
- To cancel subject registration, press the  button.
- If the camera can no longer track the registered subject, the focus area disappears. Register the subject again.

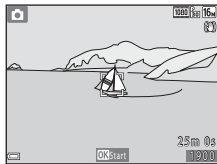

### 2 Press the shutter-release button fully to take the picture.

- If the shutter-release button is pressed while the focus area is not displayed, the camera focuses on the area in the center of the frame.

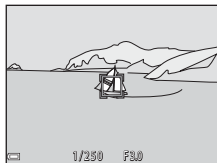

### Notes About Subject Tracking

- If you perform operations such as zooming while the camera is tracking the subject, the registration is canceled.
- Subject tracking may not be possible in certain shooting conditions.

# The Smart Portrait Menu

- See “Image Mode Settings (Image Size and Quality)” (📷27) for information about **Image mode**.

## Skin Softening

Enter smart portrait mode → MENU button → Skin softening → Ⓜ button

Option	Description
 On (default setting)	When the shutter is released, the camera detects one or more human faces (up to three), and processes the image to soften facial skin tones before saving the image.
Off	Turns skin softening off.

The result of skin softening effect on your subject cannot be confirmed when framing images for shooting. Check the results in playback mode, after taking images.

## Smile Timer

Enter smart portrait mode → MENU button → Smile timer → Ⓜ button

The camera detects human faces and then automatically releases the shutter whenever a smile is detected.

Option	Description
 On (default setting)	Enables the smile timer.
Off	Turns the smile timer off.



## Blink Proof

Enter smart portrait mode → MENU button → Blink proof → OK button

Option	Description
 On	<p>The camera automatically releases the shutter twice with every shot and saves one image in which the subject's eyes are open.</p> <ul style="list-style-type: none"><li>• If the camera saved an image in which the subject's eyes may have been closed, the dialog shown on the right is displayed for a few seconds.</li><li>• The flash cannot be used.</li></ul>
Off (default setting)	Turns the blink proof off.



## The Playback Menu

- See “Editing Still Images” (📷8) for information about image editing functions.

### Print Order (Creating a DPOF Print Order)

Press the  button (playback mode) → MENU button → Print order →  button

If you configure print order settings in advance, you can use them with the printing methods listed below.

- Taking the memory card to a digital photo lab that supports DPOF (Digital Print Order Format) printing.
- Inserting the memory card into a DPOF-compatible printer’s card slot.
- Connecting the camera to a PictBridge-compatible printer (📷18).

- 1 Use the multi selector ▲▼ to select **Select images** and press the  button.

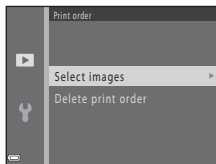

## 2 Select images (up to 99) and the number of copies (up to nine) of each.

- Use the multi selector ◀▶ to select images, and use ▲▼ to specify the number of copies to be printed.
- Images selected for printing are indicated by 🖨️ and the numeral indicating the number of copies to be printed. If no copies have been specified for images, the selection is canceled.
- Move the zoom control toward **T** (🔍) to switch to full-frame playback or **W** (🖼️) to switch to thumbnail playback.
- Press the **OK** button when setting is complete.



## 3 Select whether or not to print shooting date and shooting information.

- Select **Date** and press the **OK** button to print the shooting date on all images.
- Select **Info** and press the **OK** button to print the shutter speed and aperture value on all images.
- Lastly, select **Done** and press the **OK** button to complete the print order.

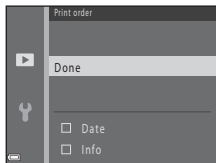

## ✓ Notes About Printing Shooting Date and Shooting Information

- Some printers may not be able to print the shooting date and shooting information.
- Shooting information is not printed when the camera is connected to a printer.
- The **Date** and **Info** settings are reset each time the **Print order** option is displayed.
- The date printed is that saved when the image was captured.
- For images taken with the **Print date** (62) option enabled, only the date and time imprinted at the time of shooting are printed, even if the **Print order** date option is enabled for the images.



## ✎ Canceling Existing Print Order

Select **Delete print order** in step 1 of "Print Order (Creating a DPOF Print Order)" (42).

## ✎ More Information

See "Printing Images of Size 1:1" (28) for more information.

# Slide Show

Press the  button (playback mode) → MENU button → Slide show →  button



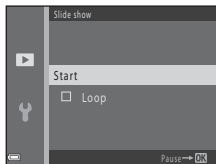

Play back images one by one in an automated "slide show." When movie files are played back in the slide show, only the first frame of each movie is displayed.

## 1 Use the multi selector ▲▼ to select **Start** and press the button.

- The slide show begins.
- To repeat the slide show automatically, select **Loop** and press the  button before selecting **Start**.
- The maximum playback time is up to about 30 minutes even if **Loop** is enabled.



## 2 Select End or Restart.



- The screen shown on the right is displayed after the slide show ends or is paused. To exit the show, select  and then press the  button. To resume the slide show, select  and then press the  button.



### Operations During Playback

- Use  to display the previous/next image. Press and hold to rewind/fast forward.
- Press the  button to pause or end the slide show.

## Protect

Press the  button (playback mode) → MENU button → Protect →  button

The camera protects selected images from accidental deletion.

Select images to protect or cancel protection for previously protected images from the image selection screen (47).

Note that formatting the camera's internal memory or the memory card permanently deletes protected files (67).

## The Image Selection Screen

When an image selection screen such as the one shown on the right is displayed while operating the camera, follow the procedures described below to select the images.



### 1 Use the multi selector ◀▶ to select an image.

- Move the zoom control (◻ 1) toward **T** (🔍) to switch to full-frame playback or **W** (🖼️) to switch to thumbnail playback.
- When selecting an image for **Rotate image**, **Choose key picture**, or **Welcome screen**, or when using the **Print selection** screen to print individual images, only one image can be selected. Proceed to step 3.



### 2 Use ▲▼ to select or deselect (or to specify the number of copies).

- When an image is selected, an icon is displayed below the image. Repeat steps 1 and 2 to select additional images.



### 3 Press the (OK) button to apply image selection.



- When **Selected images** is selected, a confirmation dialog is displayed. Follow the instructions displayed in the monitor.

## Rotate Image

Press the  button (playback mode) → MENU button → Rotate image →  button

Specify the orientation in which saved images are displayed during playback.

Still images can be rotated 90 degrees clockwise or 90 degrees counterclockwise.

Select an image from the image selection screen (47). When the Rotate image screen is displayed, press the multi selector  to rotate the image 90 degrees.



Rotate 90 degrees  
counterclockwise

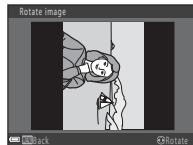



Rotate 90 degrees  
clockwise

Press the  button to finalize display orientation, and save orientation information with the image.





## Copy (Copy Between Internal Memory and Memory Card)

Press the  button (playback mode) → MENU button → Copy →  button

Copy images between the internal memory and a memory card.

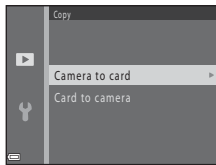
- 1 Use the multi selector ▲▼ to select a destination option to which images are copied and press the  button.



- 2 Select a copy option and press the  button.

- If you choose the **Selected images** option, use the image selection screen to specify images (47).

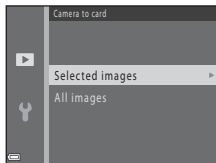

## **Notes About Copying Images**

- Only files in formats that this camera can record can be copied.
- Operation is not guaranteed with images captured with another make of camera or that have been modified on a computer.
- The **Print order** (42) settings configured for images are not copied.

## **Notes About Copying Images in a Sequence**

- If you select a key picture of a sequence in **Selected images**, all images in the sequence are copied.
- If you press the **MENU** button while images in a sequence are displayed, only the **Card to camera** copy option is available. All images in the sequence are copied if you select **Current sequence**.



## **Copying to a Memory Card That Contains No Images**

When the camera is switched to playback mode, **Memory contains no images.** is displayed. Press the **MENU** button to select **Copy**.

## Sequence Display Options



Press the  button (playback mode) → MENU button → Sequence display options →  button

Select the method used to display images in the sequence (6).

Option	Description
 Individual pictures	Displays each image in a sequence individually.  is displayed on the playback screen.
 Key picture only (default setting)	Displays only the key picture for images in a sequence.

Settings are applied to all sequences, and the setting is saved in the camera's memory even if the camera is turned off.

## Choose Key Picture

Press the  button (playback mode) → display a sequence for which you want to change the key picture → MENU button → Choose key picture →  button

Specify a different image in the sequence as the key picture.

- When the key picture selection screen is displayed, select an image (47).

# The Movie Menu

## Movie Options











Enter shooting mode → MENU button →  menu icon → Movie options →  button

Select the desired movie option to record.

Select normal speed movie options to record at normal speed, or HS movie options () to record in slow or fast motion.

Memory cards (Class 6 or higher) are recommended for recording movies () 18).

## Normal Speed Movie Options

Option (Image size/Frame rate <sup>1</sup> , File format)	Image size	Aspect ratio (horizontal to vertical)
 1080/30p		
 1080/25p (default setting)	1920 × 1080	16:9
 1080/60i		
 1080/50i	1920 × 1080	16:9
 720/30p		
 720/25p	1280 × 720	16:9
 iFrame 720/30p <sup>2</sup>		
 iFrame 720/25p <sup>2</sup>	1280 × 720	16:9
 480/30p		
 480/25p	640 × 480	4:3





<sup>1</sup> The available options and frame rates vary depending on **TV settings > Video mode** setting in the setup menu ( 72).

<sup>2</sup> iFrame is a format supported by Apple Inc.

## HS Movie Options

Recorded movies are played back in fast or slow motion.

See “Playing Back in Slow Motion and Fast Motion” (854).

Option	Image size Aspect ratio (horizontal to vertical)	Description
 HS 240/8x	320 × 240 4:3	1/8-speed slow motion movies <ul style="list-style-type: none"><li>Max. recording time: 10 seconds (playback time: 1 minute and 20 seconds)</li></ul>
 HS 480/4x	640 × 480 4:3	1/4-speed slow motion movies <ul style="list-style-type: none"><li>Max. recording time: 15 seconds (playback time: 1 minute)</li></ul>
 HS 720/2x	1280 × 720 16:9	1/2-speed slow motion movies <ul style="list-style-type: none"><li>Max. recording time: 30 seconds (playback time: 1 minute)</li></ul>
 HS 1080/0.5x	1920 × 1080 16:9	2x speed fast motion movies <ul style="list-style-type: none"><li>Max. recording time: 2 minutes (playback time: 1 minute)</li></ul>

### Notes About HS Movie

- Sound is not recorded.
- Zoom position, focus, exposure, and white balance are locked when movie recording starts.

## **Playing Back in Slow Motion and Fast Motion**

**When recording at normal speed:**

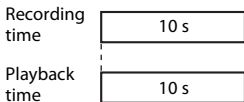

**When recording at  $\frac{480}{\text{FPS}}$  /  $\frac{480}{\text{FPS}}$  HS 480/4x:**

Movies are recorded at 4x normal speed.

They are played back in slow motion at 4x slower speed.

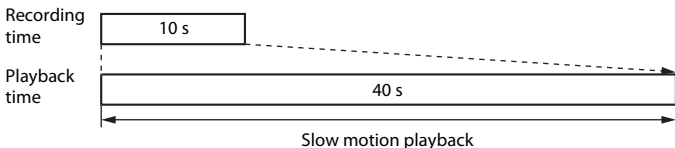

**When recording at  $\frac{1080}{\text{FPS}}$  /  $\frac{1080}{\text{FPS}}$  HS 1080/0.5x:**

Movies are recorded at 1/2 normal speed.



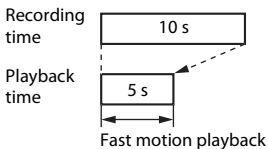

They are played back in fast motion at 2x faster speed.





## AF Area Mode

Enter shooting mode → MENU button →  menu icon → AF area mode →  button

Set the focus area in movie mode.



Option	Description
 Face priority (default setting)	When the camera detects a human face, it focuses on that face (  57). When <b>Autofocus mode</b> in the movie menu is set to <b>Single AF</b> , and no faces are detected before the  (  movie-record) button is pressed, the camera focuses on the area in the center of the frame.
[  ] Center	The camera focuses on the subject in the center of the frame.

- When **Movie options** is set to  **1080/60i** or  **1080/50i**, and **Movie VR** is set to **On (hybrid)**, the setting is fixed at **Center**.
- When an HS movie option is selected in **Movie options**, the setting is fixed at **Center**.

## Autofocus Mode

Enter shooting mode → MENU button →  menu icon → Autofocus mode →  button

Set how the camera focuses in movie mode.



Option	Description
AF-S Single AF (default setting)	Focus is locked when the  (  movie-record) button is pressed to start recording. Select this option when the distance between the camera and the subject will remain fairly consistent.
AF-F Full-time AF	Camera focuses continuously. Select this option when the distance between the camera and subject will change significantly during recording. The sound of the camera focusing may be heard in the recorded movie. Use of <b>Single AF</b> is recommended to prevent the sound of the camera focusing from interfering with recording.

- When an HS movie option is selected in **Movie options**, the setting is fixed at **Single AF**.

## Movie VR

Enter shooting mode → MENU button →  menu icon → Movie VR →  button

Select the vibration reduction setting used when recording movies.  
Set to **Off** when using a tripod to stabilize the camera during shooting.

Option	Description
 * On (hybrid) (default setting)	Movies are corrected optically using the lens shift method, and at the same time digitally processed to reduce the effects of camera shake. The angle of view (i.e., the area visible in the frame) becomes narrower.
 On	The effects of camera shake are reduced using the lens shift method.
Off	Vibration reduction is disabled.

- When an HS movie option is selected in **Movie options**, the setting is fixed at **Off**.

### Notes About Movie VR

- Vibration reduction may be unable to completely eliminate the effects of camera shake in some situations.
- After turning on the camera or after switching from playback mode to shooting mode, wait for the shooting mode screen to be displayed completely before taking images.

## Wind Noise Reduction

Enter shooting mode → MENU button →  menu icon → Wind noise reduction →  button

Set whether or not to reduce wind noise during movie recording.



Option	Description
 On	Reduces the sound produced when wind passes over the microphone. Other sounds may become difficult to hear during playback.
Off (default setting)	Wind noise reduction is not enabled.

- When an HS movie option is selected in **Movie options**, the setting is fixed at **Off**.





# The Setup Menu

## Welcome Screen

MENU button →  menu icon → Welcome screen →  button







Configure the welcome screen that is displayed when you turn on the camera.

Option	Description
None (default setting)	Does not display the welcome screen.
COOLPIX	Displays a welcome screen with the COOLPIX logo.
Select an image	<p>Displays an image selected for the welcome screen.</p> <ul style="list-style-type: none"><li>• The image selection screen is displayed. Select an image (47) and press the  button.</li><li>• Because a copy of the selected image is saved in the camera, it will be displayed when the camera is turned on, even if the original image is deleted.</li><li>• An image cannot be selected when the image is captured using <b>Easy panorama</b>, or if the image size is extremely small after the small picture or crop function is applied.</li></ul>

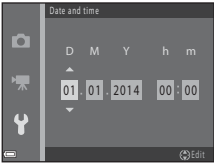

## Time Zone and Date

MENU button →  menu icon → Time zone and date →  button

Set the camera clock.

Option	Description
Date and time	<ul style="list-style-type: none"><li>• Select an item: Press the multi selector  (changes between <b>D</b>, <b>M</b>, <b>Y</b>, <b>h</b>, and <b>m</b>).</li><li>• Edit the date and time: Press  .</li><li>• Apply the setting: Select <b>m</b> and press the  button.</li></ul> 
Date format	Select <b>Year/Month/Day</b> , <b>Month/Day/Year</b> , or <b>Day/Month/Year</b> .
Time zone	Set time zone and daylight saving time. <ul style="list-style-type: none"><li>• When <b>Travel destination</b> () is set after having set the home time zone () the time difference between the travel destination and the home time zone is automatically calculated, and the date and time are saved for the selected region.</li></ul>

## Setting the Time Zone

- 1 Use the multi selector   to select **Time zone** and press the  button.

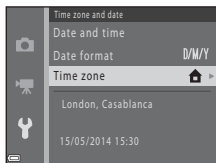

## 2 Select **Home time zone** or **Travel destination** and press the button.



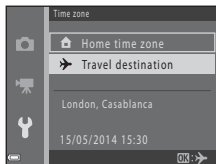

- The date and time displayed in the monitor changes depending on whether the home time zone or travel destination is selected.

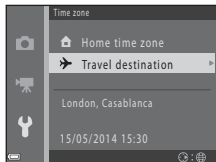

## 3 Press .



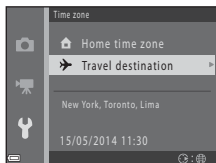
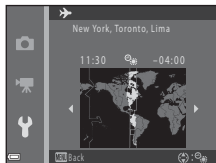

## 4 Use to select the time zone.

- Press  to enable daylight saving time function, and  is displayed. Press  to disable the daylight saving time function.
- Press the  button to apply the time zone.
- If the correct time is not displayed for the home or travel destination time zone setting, set the appropriate time in **Date and time**.







# Monitor Settings

MENU button →  menu icon → Monitor settings →  button

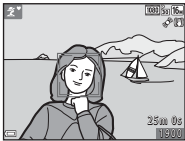
Option	Description
Photo info	Set whether or not to display information in the monitor.
Image review	This setting determines whether or not the captured image is displayed immediately after shooting. <ul style="list-style-type: none"><li>• Default setting: <b>On</b></li></ul>
Brightness	Set the monitor brightness to one of 6 levels. <ul style="list-style-type: none"><li>• Default setting: <b>3</b></li><li>• <b>6</b> is suitable when very bright light under the open sky makes the monitor difficult to see. Colors may appear different from the actual image.</li></ul>

## Photo Info

	Shooting mode	Playback mode
Show info		
Auto info (default setting)	Current settings and operation guide are displayed as in <b>Show info</b> . If no operations are performed for a few seconds, the information is hidden as in <b>Hide info</b> . Information is displayed again when the next operation is performed.	

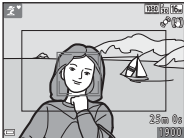

	Shooting mode	Playback mode
Hide info		
Framing grid+auto info	 <p>In addition to information shown with <b>Auto info</b>, a framing grid is displayed to help frame images. The framing grid is not displayed when recording movies.</p>	The current settings or operation guide is displayed as in <b>Auto info</b> .
Movie frame+auto info	 <p>In addition to information shown with <b>Auto info</b>, a frame is displayed before recording begins that represents the area that will be captured when recording movies. The movie frame is not displayed when recording movies.</p>	The current settings or operation guide is displayed as in <b>Auto info</b> .

## Print Date (Imprinting Date and Time)





MENU button →  menu icon → Print date →  button

The shooting date and time can be imprinted on the images when shooting, allowing the information to be printed even from printers that do not support date printing (44).



Option	Description
 Date	Date is imprinted on images.
 Date and time	Date and time are imprinted on images.
Off (default setting)	Date and time are not imprinted on images.

### Notes About Print Date



- Imprinted dates form a permanent part of image data and cannot be deleted. The date and time cannot be imprinted on images after they have been captured.
- The date and time cannot be imprinted in the following situations:
  - When using **Sports**, **Night portrait** (when  **Hand-held** is selected), **Night landscape** (when  **Hand-held** is selected), **Museum**, **Backlighting** (when **HDR** is set to **ON**), **Easy panorama**, or **Pet portrait** (when  **Continuous** is selected) scene mode
  - When **Blink proof** (41) is set to **On**
  - When the continuous shooting setting (32) is set to **Continuous H**, **Continuous L**, **Continuous H: 120 fps**, **Continuous H: 60 fps**, or **BSS**
  - When shooting movies
  - When saving still images while shooting movies
  - When extracting still images from movies
- The imprinted date and time may be difficult to read when using a small image size.

# Photo VR

MENU button →  menu icon → Photo VR →  button

Set to reduce the effects of camera shake while shooting still images.



Set to **Off** when using a tripod to stabilize the camera during shooting.

Option	Description
 * On (hybrid)	The effects of camera shake are optically reduced using the lens shift method. Under the following conditions, images are corrected digitally using image processing. <ul style="list-style-type: none"><li>• Flash: Does not fire</li><li>• Shutter speed: Slower than 1/30 second (at the wide-angle position) or 1/250 second (at the telephoto position)</li><li>• Self-timer: Off</li><li>• <b>Continuous</b> setting: <b>Single</b></li><li>• ISO sensitivity: 200 or lower</li></ul> It may take more time than usual to save images.
 On (default setting)	The effects of camera shake are reduced using the lens shift method.
Off	Vibration reduction is disabled.





## Notes About Photo VR

- After turning on the camera or after switching from playback mode to shooting mode, wait for the shooting mode screen to be displayed completely before taking images.
- Images displayed in the camera monitor immediately after shooting may be displayed blurry.
- Vibration reduction may be unable to completely eliminate the effects of camera shake in some situations.
- When the shutter speed is extremely slow, images cannot be corrected by image processing even when this function is set to **On (hybrid)**.
- When using some scene modes, special effects mode, and smart portrait mode, images cannot be corrected by image processing even when this function is set to **On (hybrid)**.

# Motion Detection

MENU button →  menu icon → Motion detection →  button

Enable motion detection to reduce the effects of subject movement and camera shake when shooting still images.

Option	Description
 <b>Auto</b> (default setting)	Motion detection is enabled with some shooting modes or settings, when  is displayed on the shooting screen. When the camera detects subject movement or camera shake,  turns green, and the ISO sensitivity and shutter speed are automatically increased to reduce blurring. <ul style="list-style-type: none"><li>• Set <b>ISO sensitivity</b> (34) to <b>Auto</b> in  (auto) mode.</li></ul>
Off	Motion detection is disabled.

## Notes About Motion Detection

- Motion detection may be unable to eliminate the effects of subject movement and camera shake in some situations.
- Motion detection may be disabled if the subject exhibits significant movement or is too dark.
- The images captured using motion detection may be somewhat “grainy” in appearance.





## AF Assist

MENU button →  menu icon → AF assist →  button

Enable or disable the AF-assist illuminator which assists autofocus operation.

Option	Description
<b>AUTO Auto</b> (default setting)	The AF-assist illuminator automatically lights up when the subject is dimly lit. The illuminator has a range of about 5.0 m (16 ft) at the maximum wide-angle position and about 5.0 m (16 ft) at the maximum telephoto position. <ul style="list-style-type: none"><li>Note that for some scene modes or focus areas, the AF-assist illuminator may not light.</li></ul>
Off	The AF-assist illuminator does not light.

## Sound Settings

MENU button →  menu icon → Sound settings →  button

Option	Description
Button sound	When <b>On</b> (default setting) is selected, the camera produces one beep when operations are performed, two beeps when focus is acquired on the subject, and three beeps when an error occurs. The start-up sound is also produced. <ul style="list-style-type: none"><li>Sounds are disabled when using <b>Pet portrait</b> scene mode.</li></ul>
Shutter sound	When <b>On</b> (default setting) is selected, the shutter sound is produced when the shutter is released. <ul style="list-style-type: none"><li>The shutter sound is not produced when using continuous shooting mode, when recording movies, or when using <b>Pet portrait</b> scene mode.</li></ul>

## Auto Off

MENU button →  menu icon → Auto off →  button



Set the amount of time that elapses before the camera enters standby mode ( 21).

Option	Description
Auto off	Select <b>30 s</b> (default setting), <b>1 min</b> , <b>5 min</b> , or <b>30 min</b> .
Sleep mode	If <b>On</b> (default setting) is selected, the camera enters standby mode when there is no change in the brightness of the subject, even before the time selected for <b>Auto off</b> has elapsed. The camera enters standby mode after 30 seconds when <b>Auto off</b> is set to <b>1 min</b> or less, or after one minute when <b>Auto off</b> is set to <b>5 min</b> or more.

### Notes About Auto Off

- The time that passes before the camera enters standby mode is fixed in the following situations:
  - When shooting using **Pet portrait auto release**: 5 minutes (when auto off is set to **30 s** or **1 min**)
  - When shooting using **Smile timer**: 5 minutes (when auto off is set to **30 s** or **1 min**)
  - When a menu is displayed: 3 minutes (when auto off is set to **30 s** or **1 min**)
  - When the audio/video cable is connected: 30 minutes
  - When an HDMI cable is connected: 30 minutes
- The camera does not enter standby mode when using the AC Adapter EH-67.

## Format Memory/Format Card

MENU button →  menu icon → Format memory/Format card →  button

Use this option to format the internal memory or a memory card.

**Formatting the internal memory or memory cards permanently deletes all data. Data that has been deleted cannot be recovered.** Make sure to transfer important images to a computer before formatting.

- Do not turn the camera off or open the battery-chamber/memory card slot cover during formatting.

### Formatting the Internal Memory

Remove the memory card from the camera. The **Format memory** option is displayed in the setup menu.

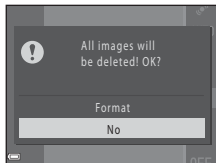

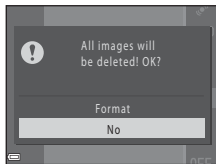

### Formatting Memory Cards

Insert a memory card in the camera. The **Format card** option is displayed in the setup menu.





## Language



MENU button →  menu icon → Language →  button

Select a language for display of camera menus and messages.

## TV Settings

MENU button →  menu icon → TV settings →  button

Adjust settings for connection to a TV.



Option	Description
Video mode	Select from <b>NTSC</b> and <b>PAL</b> . Both <b>NTSC</b> and <b>PAL</b> are standards for analog color television broadcasting. <ul style="list-style-type: none"><li>The frame rate settings available for <b>Movie options</b> () vary depending on the <b>Video mode</b> setting.</li></ul>
HDMI	Select a resolution for HDMI output. When <b>Auto</b> (default setting) is selected, the option best suited to the TV to which the camera is connected is automatically selected from <b>480p</b> , <b>720p</b> , or <b>1080i</b> .
HDMI device control	When <b>On</b> (default setting) is selected, the HDMI-CEC-compatible TV's remote control can be used to control the camera during playback (  )



### HDMI and HDMI-CEC

HDMI (High-Definition Multimedia Interface) is a multimedia interface. HDMI-CEC (HDMI-Consumer Electronics Control) allows compatible devices to inter-operate.

## Blink Warning

MENU button →  menu icon → Blink warning →  button



Select whether or not the camera detects human subjects that have blinked using face detection ( 57) when shooting in the following modes:

-  (easy auto) mode
- **Portrait** or **Night portrait** scene mode ( 32)
-  (auto) mode (when **Face priority** ( 36) is selected for AF area mode option)

Option	Description
On	When one or more human subjects may have blinked in an image captured using face detection, the <b>Did someone blink?</b> screen is displayed in the monitor. Check the image and determine whether or not another image should be captured.
Off (default setting)	Blink warning is disabled.

## The Blink Warning Screen

Faces detected by the blink warning are displayed inside a border. The operations described below are available.

- To enlarge the face: Move the zoom control toward **T** (). If more than one face is detected, use the multi selector  to select the desired face.
- To switch to full-frame playback: Move the zoom control toward **W** ().



If you press the  button, or if no operations are performed for a few seconds, the camera returns to shooting mode.

### Notes About Blink Warning



- The blink warning is disabled at continuous settings other than **Single** ( 32).
- The blink warning may not function properly in some shooting conditions.



# Eye-Fi Upload

MENU button →  menu icon → Eye-Fi upload →  button

Select whether or not the camera's Eye-Fi card (available from third-party manufacturers) sends images to your computer.





Option	Description
 <b>Enable</b> (default setting)	Upload images created by the camera to a preselected destination.
 <b>Disable</b>	Images are not uploaded.

## Notes About Eye-Fi Cards

- Note that images will not be uploaded if signal strength is insufficient even if **Enable** is selected.
- Remove your Eye-Fi card from the camera where wireless devices are prohibited. Signals may be transmitted even if **Disable** is selected.
- Refer to the instruction manual of your Eye-Fi card for more information. In the event of malfunction, contact the card manufacturer.
- The camera can be used to turn Eye-Fi cards on and off, but may not support other Eye-Fi functions.
- The camera is not compatible with the Endless Memory function. When it is set on a computer, disable the function. If the Endless Memory function is enabled, the number of images taken may not be displayed correctly.
- Eye-Fi cards are for use only in the country of purchase. Observe all local laws concerning wireless devices.
- Leaving the setting as **Enable** will result in the batteries being depleted in a shorter period of time.

## Eye-Fi Communication Indicator

The communication status of the Eye-Fi card in the camera can be confirmed in the monitor ( 8, 10).

- : **Eye-Fi upload** is set to **Disable**.
-  (lights): Eye-Fi upload enabled; waiting to begin upload.
-  (flashes): Eye-Fi upload enabled; uploading data.
- : Eye-Fi upload enabled but no images available for upload.
- : An error occurred. The camera cannot control the Eye-Fi card.

## Reset All

MENU button →  menu icon → Reset all →  button

When **Reset** is selected, the camera's settings are restored to their default values.



- Some settings, such as **Time zone and date** or **Language**, are not reset.







### Resetting File Numbering

To reset file numbering to "0001", delete all images saved in the internal memory or on the memory card ( 29) before selecting **Reset all**.

## Battery Type

MENU button →  menu icon → Battery type →  button

To ensure that the camera shows the correct battery level ( 20), select the type that matches the batteries currently in use.

Option	Description
 Alkaline (default setting)	LR6/L40 (AA-size) alkaline batteries
 COOLPIX (Ni-MH)	Nikon EN-MH2 rechargeable Ni-MH (nickel metal hydride) batteries
 Lithium	FR6/L91 (AA-size) lithium batteries

## Firmware Version





MENU button →  menu icon → Firmware version →  button











View the current camera firmware version.













## Error Messages

Refer to the table below if an error message is displayed.

Display	Cause/Solution	
The camera will turn off to prevent overheating.	Either the inside of the camera or the batteries have become hot. The camera turns off automatically. Wait until the camera or the batteries have cooled before resuming use.	–
Memory card is write protected.	The write-protect switch is in the “lock” position. Slide the write-protect switch to the “write” position.	–
This card cannot be used.	An error occurred while accessing the memory card. <ul style="list-style-type: none"> <li>• Use an approved card.</li> <li>• Check that the terminals are clean.</li> <li>• Confirm that the memory card is correctly inserted.</li> </ul>	14,  :18
This card cannot be read.		
Card is not formatted. Format card?	The memory card has not been formatted for use in the camera. Formatting deletes all data saved on the memory card. If you need to keep copies of any images, make sure to select <b>No</b> and save the copies to a computer or other medium before formatting the memory card. Select <b>Yes</b> and press the  button to format the memory card.	 :5
Not available if Eye-Fi card is locked.	The write-protect switch of the Eye-Fi card is in the “lock” position.	–
	An error occurred while accessing the Eye-Fi card. <ul style="list-style-type: none"> <li>• Check that the terminals are clean.</li> <li>• Confirm that the Eye-Fi card is correctly inserted.</li> </ul>	14
Out of memory.	Delete images or insert a new memory card.	14, 29, 71

Display	Cause/Solution	
Image cannot be saved.	An error occurred while saving the image. Insert a new memory card or format the internal memory or memory card.	 67
	The camera has run out of file numbers. Insert a new memory card or format the internal memory or memory card.	 67
	The image cannot be used for the welcome screen.	 57
	There is insufficient space to save the copy. Delete images from the destination.	29
Image cannot be modified.	Select images that support the editing function.	 8,  12
Cannot record movie.	A time-out error occurred while saving the movie on the memory card. Select a memory card with a faster write speed.	66,  18
Memory contains no images.	There are no images in the internal memory or on the memory card. <ul style="list-style-type: none"> <li>Remove the memory card from the camera to play back images in the camera's internal memory.</li> <li>To copy the images saved in the camera's internal memory to the memory card, press the <b>MENU</b> button to select <b>Copy</b> in the playback menu.</li> </ul>	15  49
File contains no image data.	The file was not created or edited with this camera. The file cannot be viewed on this camera. View the file using a computer or the device used to create or edit this file.	–
All images are hidden.	There are no images available for a slide show.	 45
This image cannot be deleted.	The image is protected. Disable protection.	 46

Display	Cause/Solution	
Raise the flash.	The flash is lowered. Raise the flash when shooting in <b>Night portrait</b> or <b>Backlighting</b> (when <b>HDR</b> is set to <b>OFF</b> ) scene mode.	33, 35, 44
Lens error	The lens cap may be attached, or a lens error occurred. Make sure that the lens cap has been removed, and turn the camera off and then on again. If the error persists, contact your retailer or Nikon-authorized service representative.	4, 20
Communications error	An error occurred while communicating with the printer. Turn the camera off and reconnect the USB cable.	 19
System error	An error occurred in the camera's internal circuitry. Turn the camera off, remove and reinsert the batteries, and turn the camera on. If the error persists, contact your retailer or Nikon-authorized service representative.	12, 20
Printer error: check printer status.	After solving the problem, select <b>Resume</b> and press the  button to resume printing.*	–
Printer error: check paper.	Load the specified size of paper, select <b>Resume</b> , and press the  button to resume printing.*	–
Printer error: paper jam.	Remove the jammed paper, select <b>Resume</b> , and press the  button to resume printing.*	–
Printer error: out of paper.	Load the specified size of paper, select <b>Resume</b> , and press the  button to resume printing.*	–
Printer error: check ink.	There is a problem with the printer's ink. Check the ink, select <b>Resume</b> , and press the  button to resume printing.*	–

Display	Cause/Solution	
Printer error: out of ink.	Replace the ink cartridge, select <b>Resume</b> , and press the  button to resume printing.*	–
Printer error: file corrupt.	There is a problem with the image file to be printed. Select <b>Cancel</b> and press the  button to cancel printing.	–

\* See the documentation provided with your printer for further guidance and information.

# File Names

Images or movies are assigned file names as follows.

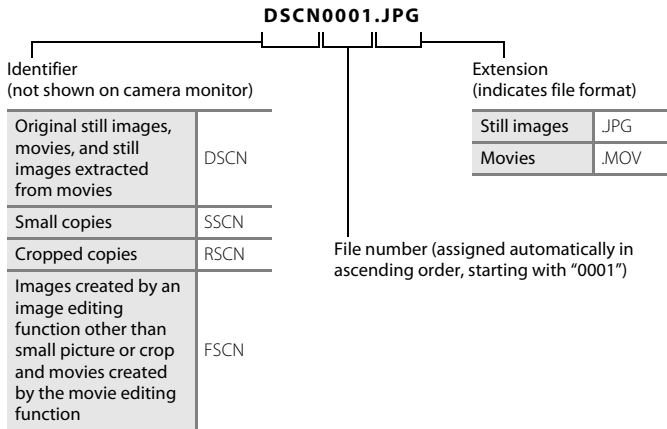

- Serial file numbers are automatically assigned to still images that are saved during movie recording (📖 68), starting from the “file number of the movie currently being recorded + 1.”

## Optional Accessories

<b>Battery charger, rechargeable batteries*</b>	<ul style="list-style-type: none"><li>• Battery Charger MH-73 (includes four EN-MH2 rechargeable Ni-MH batteries)</li><li>• Replacement rechargeable batteries: Rechargeable Ni-MH batteries EN-MH2-B4 (set of four EN-MH2 batteries)</li></ul>
<b>AC adapter</b>	AC Adapter EH-67
<b>Audio/video cable</b>	Audio Video Cable EG-CP16
<b>Hand strap</b>	Hand Strap AH-CP1

\* When using EN-MH2 rechargeable Ni-MH batteries with the camera, charge the batteries four at a time using Battery Charger MH-73. Also, do not charge batteries at the same time if they have different amounts of charge remaining (🔋:4). EN-MH1 rechargeable Ni-MH batteries cannot be used.

Availability may vary with country or region.

See our website or brochures for the latest information.



# Technical Notes and Index

<b>Caring for the Product</b> .....	<b>2</b>
The Camera.....	2
Batteries .....	3
Memory Cards .....	5
<b>Cleaning and Storage</b> .....	<b>6</b>
Cleaning.....	6
Storage.....	6
<b>Troubleshooting</b> .....	<b>7</b>
<b>Specifications</b> .....	<b>14</b>
Approved Memory Cards .....	18
<b>Index</b> .....	<b>21</b>

# Caring for the Product

## The Camera

To ensure continued enjoyment of this Nikon product, observe the precautions described below in addition to the warnings in "For Your Safety" (📖 viii-xiv) when using or storing the device.

### ✔ **Do Not Drop**

The product may malfunction if subjected to strong shock or vibration.

### ✔ **Handle the Lens and All Moving Parts with Care**

Do not apply force to the lens, lens cover, monitor, memory card slot, or battery chamber. These parts are easily damaged. Applying force to the lens cover could result in camera malfunction or damage to the lens. Should the monitor break, care should be taken to avoid injury caused by broken glass and to prevent the liquid crystal from the display touching the skin or entering the eyes or mouth.

### ✔ **Keep Dry**

The device will be damaged if immersed in water or subjected to high humidity.

### ✔ **Avoid Sudden Changes in Temperature**

Sudden changes in temperature, such as when entering or leaving a heated building on a cold day, can cause condensation to form inside the device. To prevent condensation, place the device in a carrying case or a plastic bag before exposing it to sudden changes in temperature.

### ✔ **Keep away from Strong Magnetic Fields**

Do not use or store this device in the vicinity of equipment that generates strong electromagnetic radiation or magnetic fields. Strong static charge or the magnetic fields produced by equipment such as radio transmitters could interfere with the monitor, damage data saved on the memory card, or affect the product's internal circuitry.



## **Do Not Point the Lens at Strong Light Sources for Extended Periods**

Avoid pointing the lens at the sun or other strong light sources for extended periods when using or storing the camera. Intense light may cause deterioration of the image sensor, producing a white blur effect in photographs.

## **Turn the Product off Before Removing or Disconnecting the Power Source**

Do not remove the batteries while the product is on, or while images are being saved or deleted. Forcibly cutting power in these circumstances could result in loss of data or in damage to product memory or internal circuitry.

## **Notes About the Monitor**

- Monitors and electronic viewfinders are constructed with extremely high precision; at least 99.99% of pixels are effective, with no more than 0.01% being missing or defective. Hence while these displays may contain pixels that are always lit (white, red, blue, or green) or always off (black), this is not a malfunction and has no effect on images recorded with the device.
- Images in the monitor may be difficult to see under bright lighting.
- The monitor is lit by an LED backlight. Should the monitor begin to dim or flicker, contact your Nikon-authorized service representative.

## **Batteries**

Be sure to read and follow the warnings in "For Your Safety" ( viii-xiv) before use.

## **Notes About Using Batteries**

- Used batteries may overheat. Handle with caution.
- Do not use batteries beyond their recommended expiration date.
- Do not turn the camera on and off repeatedly if discharged batteries are inserted in the camera.

## **Spare Batteries**

We recommend carrying spare batteries depending on where you are shooting. It may be difficult to purchase batteries in certain areas.

## **Charging Batteries**

If using optional rechargeable batteries, charge the batteries before taking pictures. Batteries are not charged at the time of purchase.

Be sure to read and follow the warnings noted in the operating instructions included with the battery charger.

## Charging Rechargeable Batteries

- Do not mix batteries with different amounts of charge remaining, or batteries of a different make or model.
- When using EN-MH2 batteries with this camera, charge four batteries at a time using Battery Charger MH-73. Use only Battery Charger MH-73 to charge EN-MH2 batteries.
- When using Battery Charger MH-73, only charge EN-MH2 batteries.
- EN-MH1 rechargeable Ni-MH batteries cannot be used.

## Notes About Rechargeable Ni-MH Batteries

- If you repeatedly charge rechargeable Ni-MH batteries while they still have some charge remaining, the message **Battery exhausted.** may be displayed prematurely when using the batteries. This is due to the “memory effect,” in which the amount of charge the batteries can hold decreases temporarily. Use the batteries until there is no charge remaining and they will return to their normal behavior.
- Rechargeable Ni-MH batteries discharge even when not being used. We recommend charging the batteries just before using them.

## Cold Environment Usage

Battery performance decreases in cold environments. When using the camera in cold environments, try not to let the camera and batteries become too cold. The camera may not function if you use discharged batteries in cold environments. Keep spare batteries warm and alternate between two sets of batteries. Batteries that cannot be used because they have become too cold can often be used again when they have been warmed up.

## Battery Terminals

Dirt on the battery terminals can prevent the camera from functioning. Remove dirt from the terminals using a dry cloth.

## Remaining Battery Charge

If you insert discharged batteries into the camera, the camera may indicate that the batteries have adequate charge remaining. This is a characteristic of batteries.

## Recycling

Used batteries are a valuable resource. Please recycle used batteries in accordance with local regulations. Cover the battery terminals with plastic tape when recycling.

# Memory Cards

- Use only Secure Digital memory cards. See “Approved Memory Cards” (🔧-18) for recommended memory cards.
- Observe the precautions noted in the documentation included with your memory card.
- Do not affix labels or stickers to the memory card.
- Do not format the memory card using a computer.
- The first time you insert a memory card that has been used in another device into this camera, be sure to format it with this camera. We recommend formatting new memory cards with this camera before using them with this camera.
- Note that **formatting a memory card permanently deletes all images and other data on the memory card**. If there is data saved on the memory card that you wish to keep, copy that data to a computer before formatting.
- If the message **Card is not formatted. Format card?** is displayed when the camera is turned on, the memory card must be formatted. If there is data on the memory card that you do not want to delete, select **No** and press the **OK** button. Copy that data to a computer before formatting. To format the memory card, select **Yes**.
- Observe the following precautions while formatting the memory card, saving and deleting images, and copying images to a computer, otherwise data or the memory card itself may be damaged.
  - Do not open the battery-chamber/memory card slot cover or remove the memory card or batteries.
  - Do not turn off the camera.
  - Do not disconnect the AC adapter.

# Cleaning and Storage

## Cleaning

Do not use alcohol, thinner, or other volatile chemicals.

Lens	Avoid touching glass parts with your fingers. Remove dust or lint with a blower (typically a small device with a rubber bulb attached to one end that is pumped to produce a stream of air out the other end). To remove fingerprints or other stains that cannot be removed with a blower, wipe the lens with a soft cloth, using a spiral motion that starts at the center of them and working toward the edges. If this fails, clean the lens using a cloth lightly dampened with commercial lens cleaner.
Monitor	Remove dust or lint with a blower. To remove fingerprints and other stains, clean the monitor with a soft, dry cloth, being careful not to apply pressure.
Body	Use a blower to remove dust, dirt, or sand, then wipe gently with a soft, dry cloth. After using the camera at the beach or other sandy or dusty environment, wipe off any sand, dust, or salt with a dry cloth lightly dampened with fresh water and dry thoroughly. <b>Note that foreign matter inside the camera could cause damage not covered by the warranty.</b>

## Storage

Turn the camera off when not in use. Be sure that the power-on lamp is off before putting the camera away. Remove the batteries if the camera will not be used for an extended period. Do not store the camera with naphtha or camphor moth balls, or in any of the following locations:

- Next to equipment that produces strong electromagnetic fields, such as televisions or radios
- Exposed to temperatures below  $-10^{\circ}\text{C}$  ( $14^{\circ}\text{F}$ ) or above  $50^{\circ}\text{C}$  ( $122^{\circ}\text{F}$ )
- Places that are poorly ventilated or subject to humidity of over 60%







To prevent mold or mildew, take the camera out of storage at least once a month. Turn the camera on and release the shutter a few times before putting the camera away again.









For storing the batteries, follow the precautions in "Batteries" (🔋:3) in "Caring for the Product" (🔧:2).

# Troubleshooting









If the camera fails to function as expected, check the list of common problems below before consulting your retailer or Nikon-authorized service representative.









## Power, Display, Settings Issues

Problem	Cause/Solution	
The camera is on but does not respond.	Wait for recording to end. If the problem persists, turn the camera off. If the camera does not turn off, remove and reinsert the battery or batteries or, if you are using an AC adapter, disconnect and reconnect the AC adapter. Note that although any data currently being recorded will be lost, data that have already been recorded will not be affected by removing or disconnecting the power source.	12, 20,  78
Camera turns off without warning.	<ul style="list-style-type: none"><li>• The camera automatically turns off to save power (auto off function).</li><li>• The camera or batteries have become too cold and cannot operate properly.</li><li>• The inside of the camera has become hot. Leave the camera off until the inside of the camera has cooled, and then try turning it on again.</li></ul>	21  4 –
Monitor is blank.	<ul style="list-style-type: none"><li>• The camera is off.</li><li>• The batteries are exhausted.</li><li>• The camera has entered standby mode to save power. Press the power switch, shutter-release button,  button,  button, or  (movie-record) button.</li><li>• The flash lamp flashes while the flash is charging. Wait for the flash to charge.</li><li>• The camera and computer are connected via a USB cable.</li><li>• The camera and TV are connected via an audio/video cable or HDMI cable.</li></ul>	20 20 1, 21 46 74, 77 74,  16











Problem	Cause/Solution	
Monitor is hard to read.	<ul style="list-style-type: none"> <li>Adjust the monitor brightness.</li> <li>The monitor is dirty. Clean the monitor.</li> </ul>	72,  60  6
Date and time of recording are not correct.	<ul style="list-style-type: none"> <li>If the camera clock has not been set,  flashes during shooting and movie recording. Images and movies saved before the clock is set are dated "00/00/0000 00:00" or "01/01/2014 00:00" respectively. Set the correct time and date from the <b>Time zone and date</b> option in the setup menu.</li> <li>The camera clock is not as accurate as ordinary watches or clocks. Periodically compare the time of the camera clock with that of a more accurate timepiece and reset as required.</li> </ul>	16, 72,  58
No indicators displayed in monitor.	<b>Hide info</b> is selected for <b>Photo info in Monitor settings</b> in the setup menu.	72,  60
<b>Print date</b> not available.	<b>Time zone and date</b> has not been set in the setup menu.	16, 72,  58
Date not imprinted on images even when <b>Print date</b> is enabled.	<ul style="list-style-type: none"> <li>The current shooting mode does not support <b>Print date</b>.</li> <li>The date cannot be imprinted on movies.</li> </ul>	72,  62
Screen for setting time zone and date is displayed when camera is turned on.	The clock battery is exhausted; all settings were restored to their default values.	16, 19
Camera settings reset.		
Camera becomes hot.	The camera may become hot when used for an extended period of time to shoot movies or send images using an Eye-Fi card, or when used in a hot environment; this is not a malfunction.	–
Camera makes sound.	When <b>Autofocus mode</b> is set to <b>Full-time AF</b> or while in some shooting modes, the camera may produce an audible focusing sound.	69,  55

## Shooting Issues





Problem	Cause/Solution	
Cannot switch to shooting mode.	Disconnect the HDMI cable or USB cable.	74, 77,  16,  19
No image captured when the shutter-release button is pressed.	<ul style="list-style-type: none"> <li>• When the camera is in playback mode, press the  button or the shutter-release button.</li> <li>• When menus are displayed, press the <b>MENU</b> button.</li> <li>• The batteries are exhausted.</li> <li>• When the flash lamp is flashing, the flash is charging.</li> </ul>	1, 28 3 20 46
Camera cannot focus.	<ul style="list-style-type: none"> <li>• The subject is too close. Try shooting using easy auto mode, <b>Close-up</b> scene mode, or macro mode.</li> <li>• The subject is hard to focus on.</li> <li>• Set <b>AF assist</b> in the setup menu to <b>Auto</b>.</li> <li>• Turn the camera off and then on again.</li> </ul>	31, 34, 49  60 72,  65 20
Images are blurred.	<ul style="list-style-type: none"> <li>• Use the flash.</li> <li>• Increase the ISO sensitivity value.</li> <li>• Enable vibration reduction or motion detection.</li> <li>• Use <b>BSS</b> (Best Shot Selector).</li> <li>• Use a tripod to stabilize the camera when shooting (using the self-timer at the same time is more effective).</li> </ul>	44 54,  34 72,  63,  64 35,  32 47
Bright specks appear in images captured with flash.	The flash is reflecting off particles in the air. Lower the flash.	5



Problem	Cause/Solution	
Flash does not fire.	<ul style="list-style-type: none"> <li>• The flash is lowered.</li> <li>• A scene mode that restricts the flash is selected.</li> <li>• <b>On</b> is selected for <b>Blink proof</b> in the smart portrait menu.</li> <li>• A function that restricts the flash is enabled.</li> </ul>	5, 44 51 54,  41 55
Digital zoom cannot be used.	<ul style="list-style-type: none"> <li>• Digital zoom cannot be used in the following situations.                             <ul style="list-style-type: none"> <li>- When <b>Portrait, Night portrait, Night landscape, Backlighting</b> (when <b>HDR</b> is set to <b>ON</b>), <b>Easy panorama</b>, or <b>Pet portrait</b> is selected in scene mode</li> <li>- When smart portrait mode is selected</li> <li>- When <b>Continuous</b> in the shooting menu is set to <b>Multi-shot 16</b></li> <li>- When <b>AF area mode</b> in the shooting menu is set to <b>Subject tracking</b></li> </ul> </li> </ul>	32 40 54,  32 54,  36
<b>Image mode</b> not available.	A function that restricts the <b>Image mode</b> option is enabled.	55
No sound when shutter is released.	<ul style="list-style-type: none"> <li>• <b>Off</b> is selected for <b>Sound settings &gt; Shutter sound</b> in the setup menu. No sound is produced with some shooting modes and settings, even when <b>On</b> is selected.</li> <li>• Do not block the speaker.</li> </ul>	72,  65 1
AF-assist illuminator does not light.	<b>Off</b> is selected for the <b>AF assist</b> option in the setup menu. AF-assist illuminator may not light depending on the position of the focus area or the current scene mode, even when <b>Auto</b> is selected.	72,  65
Images appear smeared.	The lens is dirty. Clean the lens.	 6
Colors are unnatural.	White balance or hue is not adjusted properly.	34, 54,  29
Randomly spaced bright pixels ("noise") appear in image.	The subject is dark, and the shutter speed is too slow or ISO sensitivity is too high. Noise can be reduced by: <ul style="list-style-type: none"> <li>• Using the flash.</li> <li>• Specifying a lower ISO sensitivity setting.</li> </ul>	44 54,  34



Problem	Cause/Solution	
Images are too dark (underexposed).	<ul style="list-style-type: none"> <li>The flash is lowered or a shooting mode that restricts the flash is selected.</li> <li>The flash window is blocked.</li> <li>The subject is beyond the range of the flash.</li> <li>Adjust exposure compensation.</li> <li>Increase ISO sensitivity.</li> <li>The subject is backlit. Select <b>Backlighting</b> scene mode or raise the flash and set the flash mode setting to  (fill flash).</li> </ul>	5, 44, 51 24  16 50 54,  34 35, 44
Images are too bright (overexposed).	Adjust exposure compensation.	50
Unexpected results when flash set to  (auto with red-eye reduction).	When taking images using the flash with  (auto with red-eye reduction), In-Camera Red Eye Fix may be applied to areas not affected by red-eye in rare cases. Use any scene mode other than <b>Night portrait</b> , and change the flash mode to any setting other than  (auto with red-eye reduction) and try taking an image again.	33, 44
Skin tones are not softened.	<ul style="list-style-type: none"> <li>In some shooting conditions, facial skin tones may not be softened.</li> <li>For images containing four or more faces, try using the <b>Skin softening</b> effect in the playback menu.</li> </ul>	58 64,  11
Saving images takes time.	It may take more time to save images in the following situations. <ul style="list-style-type: none"> <li>When the noise reduction function is in operation, such as when shooting in a dark environment</li> <li>When the flash mode is set to  (auto with red-eye reduction)</li> <li>When shooting in <b>Night portrait</b>, <b>Night landscape</b>, or <b>Backlighting</b> (when <b>HDR</b> is set to <b>ON</b>) scene mode</li> <li>When the skin softening function is applied while shooting</li> <li>When using continuous shooting mode</li> </ul>	– 46 33, 34, 35 58 54,  32

## Playback Issues

Problem	Cause/Solution	
File cannot be played back.	<ul style="list-style-type: none"> <li>• This camera may not be able to play back images saved with another make or model of digital camera.</li> <li>• This camera cannot play back movies recorded with another make or model of digital camera.</li> <li>• This camera may not be able to play back data edited on a computer.</li> </ul>	–
Cannot zoom in on image.	<ul style="list-style-type: none"> <li>• Playback zoom cannot be used with movies.</li> <li>• When viewing small images, the playback zoom ratio that is displayed may not match the actual image zoom ratio.</li> <li>• This camera may not be able to zoom in on images captured with another make or model of digital camera.</li> </ul>	–
Cannot edit image.	<ul style="list-style-type: none"> <li>• Some images cannot be edited. Images that have already been edited may not be edited again.</li> <li>• There is not enough free space in the internal memory or on the memory card.</li> <li>• This camera is unable to edit images captured with other cameras.</li> <li>• Editing functions used for images are not available for movies.</li> </ul>	36,  – – –
Cannot rotate image.	This camera cannot rotate images captured with another make or model of digital camera.	–
Images are not displayed on TV.	<ul style="list-style-type: none"> <li>• <b>Video mode</b> or <b>HDMI</b> is not correctly set in the <b>TV settings</b> setup menu.</li> <li>• The cables are connected to the HDMI micro connector (Type D) and to the USB/audio/video output connector simultaneously.</li> <li>• The memory card contains no images. Replace the memory card. Remove the memory card to play back images from the internal memory.</li> </ul>	73,  68 74, 77,  16,  19 14

Problem	Cause/Solution	
Nikon Transfer 2 does not start when camera is connected to a computer.	<ul style="list-style-type: none"> <li>• The camera is off.</li> <li>• The batteries are exhausted.</li> <li>• The USB cable is not correctly connected.</li> <li>• The camera is not recognized by the computer.</li> <li>• The computer is not set to start Nikon Transfer 2 automatically. For more information about Nikon Transfer 2, refer to help information contained in ViewNX 2.</li> </ul>	20 20 74, 77 – 79
Images to be printed are not displayed.	<ul style="list-style-type: none"> <li>• The memory card contains no images. Replace the memory card.</li> <li>• Remove the memory card to print images from the internal memory.</li> </ul>	14  15
Cannot select paper size with camera.	<p>The camera cannot be used to select the paper size in the following situations, even when printing from a PictBridge-compatible printer. Use the printer to select the paper size.</p> <ul style="list-style-type: none"> <li>• The printer does not support the paper sizes specified by the camera.</li> <li>• The printer automatically selects the paper size.</li> </ul>	74,  20,  22 –

# Specifications

## Nikon COOLPIX L830 Digital Camera

Type	Compact digital camera
Number of effective pixels	16.0 million
Image sensor	$\frac{1}{2}$ -in. type CMOS; approx. 16.76 million total pixels
Lens	NIKKOR lens with 34 $\times$ optical zoom
Focal length	4.0–136 mm (angle of view equivalent to that of 22.5–765 mm lens in 35mm [135] format)
f/-number	f/3–5.9
Construction	12 elements in 9 groups (2 ED lens elements)
Digital zoom magnification	Up to 4 $\times$ (angle of view equivalent to that of approx. 3060 mm lens in 35mm [135] format)
Vibration reduction	Combination of lens-shift and electronic VR
Motion blur reduction	Motion detection (still pictures)
Autofocus (AF)	Contrast-detect AF
Focus range	<ul style="list-style-type: none"><li>• [W]: Approx. 50 cm (1 ft 8 in.)–<math>\infty</math>,     [T]: Approx. 1.5 m (5 ft)–<math>\infty</math></li><li>• Macro mode: Approx. 1 cm (0.4 in.) (when zoom is set to middle position)–<math>\infty</math></li></ul> (All distances measured from center of front surface of lens)
Focus-area selection	Face priority, manual with 99 focus areas, center, subject tracking, target finding AF

<b>Monitor</b>	7.5 cm (3-in.), approx. 921k-dot (RGBW), wide viewing angle TFT LCD with 6-level brightness adjustment, tiltable approx. 85° downward, approx. 90° upward
<b>Frame coverage (shooting mode)</b>	Approx. 99% horizontal and 99% vertical (compared to actual picture)
<b>Frame coverage (playback mode)</b>	Approx. 100% horizontal and 100% vertical (compared to actual picture)
<b>Storage</b>	
<b>Media</b>	Internal memory (approx. 59 MB), SD/SDHC/SDXC memory card
<b>File system</b>	DCF, Exif 2.3, and DPOF compliant
<b>File formats</b>	Still pictures: JPEG Movies: MOV (Video: H.264/MPEG-4 AVC, Audio: LPCM stereo)
<b>Image size (pixels)</b>	<ul style="list-style-type: none"> <li>• 16M (High) [4608 × 3456★]</li> <li>• 16M [4608 × 3456]</li> <li>• 8M [3264 × 2448]</li> <li>• 4M [2272 × 1704]</li> <li>• 2M [1600 × 1200]</li> <li>• VGA [640 × 480]</li> <li>• 16:9 [4608 × 2592]</li> <li>• 1:1 [3456 × 3456]</li> </ul>
<b>ISO sensitivity (Standard output sensitivity)</b>	<ul style="list-style-type: none"> <li>• ISO 125–1600</li> <li>• ISO 3200 (available when using Auto mode)</li> </ul>
<b>Exposure</b>	
<b>Metering mode</b>	Matrix, center-weighted (digital zoom less than 2×), spot (digital zoom 2× or more)
<b>Exposure control</b>	Programmed auto exposure and exposure compensation (–2.0 – +2.0 EV in steps of 1/3 EV)
<b>Shutter</b>	Mechanical and CMOS electronic shutter
<b>Speed</b>	<ul style="list-style-type: none"> <li>• 1/1500–1 s</li> <li>• 1/4000 s (maximum speed during high-speed continuous shooting)</li> <li>• 4 s (<b>Fireworks show</b> scene mode)</li> </ul>

<b>Aperture</b>	Electronically-controlled ND filter (–2 AV) selection
Range	2 steps (f/3 and f/6 [W])
<b>Self-timer</b>	Can be selected from 10 s and 2 s
<b>Flash</b>	
Range (approx.) (ISO sensitivity: Auto)	[W]: 0.5–9.0 m (1 ft 8 in.–29 ft) [T]: 1.5–4.5 m (5–14 ft)
Flash control	TTL auto flash with monitor preflashes
<b>Interface</b>	Hi-Speed USB
Data transfer protocol	MTP, PTP
<b>Video output</b>	Can be selected from NTSC and PAL
<b>HDMI output</b>	Can be selected from Auto, 480p, 720p, and 1080i
<b>I/O terminal</b>	Audio/video (A/V) output; digital I/O (USB) HDMI micro connector (Type D) (HDMI output), DC input connector
<b>Supported languages</b>	Arabic, Bengali, Bulgarian, Chinese (Simplified and Traditional), Czech, Danish, Dutch, English, Finnish, French, German, Greek, Hindi, Hungarian, Indonesian, Italian, Japanese, Korean, Marathi, Norwegian, Persian, Polish, Portuguese (European and Brazilian), Romanian, Russian, Serbian, Spanish, Swedish, Tamil, Telugu, Thai, Turkish, Ukrainian, Vietnamese
<b>Power sources</b>	<ul style="list-style-type: none"> <li>• Four LR6/L40 (AA-size) alkaline batteries</li> <li>• Four FR6/L91 (AA-size) lithium batteries</li> <li>• Four EN-MH2 rechargeable Ni-MH batteries (available separately)</li> <li>• AC Adapter EH-67 (available separately)</li> </ul>

<b>Battery life<sup>1</sup></b>	
Still pictures	<ul style="list-style-type: none"> <li>• Approx. 390 shots when using alkaline batteries</li> <li>• Approx. 1180 shots when using lithium batteries</li> <li>• Approx. 680 shots when using EN-MH2 batteries</li> </ul>
Movies (actual battery life for recording) <sup>2</sup>	<ul style="list-style-type: none"> <li>• Approx. 1 h 10 min when using alkaline batteries</li> <li>• Approx. 3 h 55 min when using lithium batteries</li> <li>• Approx. 2 h 5 min when using EN-MH2 batteries</li> </ul>
Tripod socket	1/4 (ISO 1222)
Dimensions (W × H × D)	Approx. 111.0 × 75.8 × 91.2 mm (4.4 × 3.0 × 3.6 in.) (excluding projections)
Weight	Approx. 508 g (1 lb 2.0 oz) (including batteries and SD memory card)
<b>Operating environment</b>	
Temperature	0°C–40°C (32°F–104°F)
Humidity	85% or less (no condensation)

- Unless otherwise stated, all figures assume fresh LR6/L40 (AA-size) alkaline batteries and an ambient temperature of 23 ±3°C (73.4 ±5.4°F) as specified by the Camera and Imaging Products Association (CIPA).

<sup>1</sup> Battery life may vary depending on conditions of use, such as the interval between shots or the length of time that menus and images are displayed. The included batteries are for trial use only. Figures listed for lithium batteries are measured using commercially available FR6/L91 (AA-size) Energizer(R) Ultimate Lithium batteries.

<sup>2</sup> Individual movie files cannot exceed 4 GB in size or 29 minutes in length. Recording may end before this limit is reached if camera temperature becomes elevated.

## Specifications

- Nikon will not be held liable for any errors this manual may contain.
- The appearance of this product and its specifications are subject to change without notice.

## Approved Memory Cards

The following Secure Digital (SD) memory cards have been tested and approved for use in this camera.

- Memory cards with an SD Speed Class rating of 6 or faster are recommended for recording movies. When using a memory card with a lower Speed Class rating, movie recording may stop unexpectedly.

	SD memory card	SDHC memory card <sup>2</sup>	SDXC memory card <sup>3</sup>
SanDisk	2 GB <sup>1</sup>	4 GB, 8 GB, 16 GB, 32 GB	64 GB, 128 GB
TOSHIBA	–	4 GB, 8 GB, 16 GB, 32 GB	64 GB
Panasonic	2 GB <sup>1</sup>	4 GB, 8 GB, 16 GB, 32 GB	64 GB
Lexar	–	4 GB, 8 GB, 16 GB, 32 GB	64 GB, 128 GB

<sup>1</sup> If the memory card will be used with a card reader or similar device, make sure that the device supports 2 GB cards.

<sup>2</sup> SDHC compliant.

If the memory card will be used with a card reader or similar device, make sure that the device supports SDHC.



<sup>3</sup> SDXC compliant.

If the memory card will be used with a card reader or similar device, make sure that the device supports SDXC.



- Contact the manufacturer for details on the above cards. We cannot guarantee camera performance when using memory cards made by other manufacturers.



## **AVC Patent Portfolio License**

This product is licensed under the AVC Patent Portfolio License for the personal and noncommercial use of a consumer to (i) encode video in compliance with the AVC standard (“AVC video”) and/or (ii) decode AVC video that was encoded by a consumer engaged in a personal and non-commercial activity and/or was obtained from a video provider licensed to provide AVC video. No license is granted or shall be implied for any other use.

Additional information may be obtained from MPEG LA, L.L.C.

See **<http://www.mpegla.com>**.

## Trademark Information

- Microsoft, Windows and Windows Vista are either registered trademarks or trademarks of Microsoft Corporation in the United States and/or other countries.
- Mac, OS X, the iFrame logo and the iFrame symbol are trademarks or registered trademarks of Apple Inc. in the U.S. and other countries.
- Adobe and Acrobat are registered trademarks of Adobe Systems Inc.
- SDXC, SDHC and SD Logos are trademarks of SD-3C, LLC.
- PictBridge is a trademark.
- HDMI, HDMI logo and High-Definition Multimedia Interface are trademarks or registered trademarks of HDMI Licensing LLC.

## HDMI

- All other trade names mentioned in this manual or the other documentation provided with your Nikon product are trademarks or registered trademarks of their respective holders.

## FreeType License (FreeType2)

Portions of this software are copyright © 2012 The FreeType Project (<http://www.freetype.org>). All rights reserved.

## MIT License (HarfBuzz)

Portions of this software are copyright © 2014 The HarfBuzz Project (<http://www.freedesktop.org/wiki/Software/HarfBuzz>). All rights reserved.

# Index

## Symbols

<b>T</b> Telephoto .....	25
<b>W</b> Wide-angle .....	25
Playback zoom .....	62
Thumbnail playback .....	63
Easy auto mode .....	31
Scene mode .....	32
<b>SO</b> Special effects mode .....	38
Smart portrait mode .....	40
Auto mode .....	42
Playback mode .....	28
Setup menu .....	72,  57
Apply selection button .....	3
Shooting mode button .....	3
Movie-record button .....	3
Playback button .....	3, 28
Delete button .....	3, 29
<b>MENU</b> button .....	3, 6, 53, 64, 69, 72
(flash pop-up) button .....	1, 5, 44
Flash mode .....	44
Self-timer .....	47
Macro mode .....	49
Exposure compensation .....	50
Help .....	32
<b>A</b>	
AC adapter .....	78

AF area mode .....	54, 69,  36,  55
AF assist .....	72,  65
AF-assist illuminator .....	1
Alkaline batteries .....	13
Aperture value .....	27
Audio/video cable .....	75,  16,  78
Audio/video-in jack .....	75,  16
Auto flash .....	45
Auto mode .....	42
Auto off .....	21, 72,  66
Autofocus .....	60
Autofocus mode .....	69,  55
<b>B</b>	
Backlighting  .....	32, 35
Battery .....	12, 19
Battery charger .....	78
Battery level .....	20
Battery type .....	73,  72
Battery-chamber/memory card slot cover .....	3, 14
Beach  .....	32
Best shot selector .....	35,  32
Black and white copy  .....	32, 35
Black-and-white .....	35
Blink proof .....	54,  41
Blink warning .....	73,  69

Brightness .....		60
BSS .....		35,
Button sound .....		65
<b>C</b>		
Calendar display .....		63
Choose key picture .....		64,
Close-up		32, 34
Color options .....		54,
Compression ratio .....		27
Computer .....		75, 77
Connector cover .....		1
Continuous shooting .....		54,
Copy .....		64,
Crop .....		15
Cross process		38
Cyanotype .....		35
<b>D</b>		
Date and time .....		16, 72,
Date format .....		17,
Daylight saving time .....		17,
Delete .....		29
Digital zoom .....		25
Direct print .....		75,
D-Lighting .....		64,
DPOF print .....		24
DSCN .....		77
Dusk/dawn		32

<b>E</b>		
Easy auto mode .....		31
Easy panorama		32, 36,
Easy panorama playback .....		36,
Editing movies .....		25
EN-MH2 .....		78,
Exposure compensation .....		50
Extension .....		77
Extracting still images .....		71,
Eye-Fi upload .....		73,
Eyellet for camera strap .....		1
<b>F</b>		
Face detection .....		57
Face priority .....		36,
File name .....		77
Fill flash .....		45
Filter effects .....		64,
Fireworks show		32, 35
Firmware version .....		73,
Fixed range auto .....		34
Flash .....		1, 5, 44
Flash lamp .....		3, 46
Flash mode .....		44
Flash pop-up button .....		1, 5, 44
Focus .....		26, 57
Focus area .....		26
Focus indicator .....		9
Focus lock .....		61

Food  ..... 32, 34

Format internal memory ..... 73, 67

Format memory cards ..... 15, 73, 67

Formatting ..... 15, 73, 67

FSCN ..... 77

Full-frame playback ..... 28

Full-time AF ..... 69, 55

**H**

HDMI ..... 68

HDMI cable ..... 75, 16



HDMI device control ..... 68

HDMI micro connector ..... 1

Help ..... 32

High key  ..... 38

High-contrast monochrome  ..... 38

HS movie ..... 69, 53, 54

**I**

Identifier ..... 77





Image mode ..... 54, 27

Image review ..... 60

Imprinting date and time ..... 19, 62

Internal memory ..... 15

ISO sensitivity ..... 54, 34

**J**

JPG ..... 77

**L**

Landscape  ..... 32

Language ..... 73, 68

Lens ..... 1, 14

Lithium batteries ..... 13

Low key  ..... 38

**M**

Macro mode ..... 49

Memory card ..... 14, 18

Memory card slot ..... 14

Microphone (stereo) ..... 1

Monitor ..... 3, 8, 6

Monitor settings ..... 72, 60

Motion detection ..... 72, 64

MOV ..... 77

Movie length ..... 65

Movie menu ..... 69, 52

Movie options ..... 69, 52

Movie playback ..... 70

Movie recording ..... 65

Movie VR ..... 69, 56

Movie-record button ..... 3

Multi selector ..... 3

Multi-shot 16 ..... 32

Museum  ..... 32, 35

**N**

Night landscape  ..... 32, 34

Night portrait  ..... 32, 33

Nikon Transfer 2 ..... 77

Nostalgic sepia **SE** ..... 38

Number of exposures remaining ..... 20, 28  
**Q**  
 Optical zoom ..... 25  
 Optional accessories ..... 78  
**P**  
 Paper size ..... 20, 22  
 Party/indoor ..... 32, 33  
 Pet portrait auto release ..... 37  
 Pet portrait ..... 32, 37  
 Photo info ..... 60  
 Photo VR ..... 72, 63  
 PictBridge ..... 75, 18  
 Playback ..... 28, 70  
 Playback button ..... 3, 28  
 Playback menu ..... 64, 42  
 Playback mode ..... 28  
 Playback zoom ..... 62  
 Pop **POP** ..... 38  
 Portrait ..... 32  
 Power ..... 20  
 Power switch/power-on lamp ..... 1, 20  
 Preset manual ..... 30  
 Pressing halfway ..... 27  
 Print ..... 64, 75, 20, 22, 42  
 Print date ..... 19, 72, 62  
 Print order ..... 64, 42  
 Print order option ..... 19, 43, 44

Printer ..... 75, 18  
 Protect ..... 64, 46  
**Q**  
 Quick retouch ..... 64, 9  
**R**  
 Rechargeable battery ..... 78  
 Rechargeable nickel-metal hydride  
     batteries ..... 13  
 Recording movies ..... 65  
 Recording slow motion movies  
     ..... 69, 53, 54  
 Red-eye correction ..... 64, 10  
 Red-eye reduction ..... 45, 46  
 Reset all ..... 73, 71  
 Rotate image ..... 64, 48  
 RSCN ..... 77  
**S**  
 Scene mode ..... 32  
 Selective color ..... 38  
 Self-timer ..... 47  
 Self-timer lamp ..... 1, 48  
 Sepia ..... 35  
 Sequence display options  
     ..... 64, 66, 51  
 Setup menu ..... 72, 57  
 Shooting ..... 20, 24, 26  
 Shooting menu ..... 53, 27  
 Shooting mode button ..... 3

Shutter sound.....	65	Thumbnail playback.....	63
Shutter speed.....	27	Time difference .....	58
Shutter-release button .....	1, 26	Time zone.....	17,  58
Side zoom control .....	1, 25	Time zone and date.....	16, 72,  58
Single AF.....	69,  55	Toy camera effect 1  1.....	38
Single-frame shooting .....	54,  32	Toy camera effect 2  2.....	38
Skin softening.....	54, 64,  11,  40	Tripod socket .....	3,  17
Sleep mode.....	66	TV.....	75,  16
Slide show .....	64,  45	TV settings.....	73,  68
Slow sync .....	45	<b>U</b>	
Small picture .....	64,  14	USB cable .....	74, 77,  19
Smart portrait menu.....	53,  40	USB/audio/video output connector .....	1, 74, 77,  16,  18
Smart portrait mode .....	40	<b>V</b>	
Smile timer.....	54,  40	Video mode.....	68
Snow .....	32	ViewNX 2.....	76
Soft <b>SO</b> .....	38	Vivid color.....	35
Sound settings.....	72,  65	Volume .....	70
Speaker.....	1	<b>W</b>	
Special effects mode.....	38	Welcome screen .....	72,  57
Sports .....	32, 33	White balance .....	54,  29
SSCN.....	77	Wind noise reduction.....	69,  56
Standard color.....	35	<b>Z</b>	
Strap .....	4	Zoom .....	25
Subject tracking.....	37,  39	Zoom control.....	1, 25
Sunset .....	32	Zoom in.....	25
Super vivid <b>V</b> .....	38	Zoom out .....	25
<b>I</b>			
Target finding AF.....	54, 59,  38		

No reproduction in any form of this manual, in whole or in part (except for brief quotation in critical articles or reviews), may be made without written authorization from NIKON CORPORATION.

**NIKON CORPORATION**

© 2014 Nikon Corporation



CT4C02(11)  
6MN34111-02