

# ***Nikon***

DIGITAL CAMERA

# COOLPIX S9700

## Reference Manual

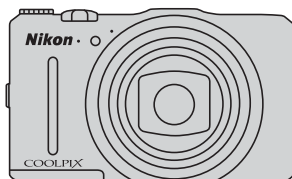

**En**



<b>Introduction</b>	
<b>Parts of the Camera</b>	
<b>The Basics of Shooting and Playback</b>	
<b>Shooting Features</b>	
<b>Playback Features</b>	
<b>Recording and Playing Back Movies</b>	
<b>General Camera Setup</b>	
<b>Using Location Data Functions/Displaying Maps</b>	
<b>Using the Wi-Fi (Wireless LAN) Function</b>	
<b>Connecting the Camera to a TV, Computer, or Printer</b>	
<b>Reference Section</b>	
<b>Technical Notes and Index</b>	

# Introduction

## Read This First

Thank you for purchasing the Nikon COOLPIX S9700 digital camera. Before using the camera, please read the information in "For Your Safety" (vii-ix), "<Important> Notes About Location Data Functions (GPS/GLONASS, Electronic Compass)" (xii), and "Wi-Fi (Wireless LAN Network)" (xiv), and familiarize yourself with the information provided in this manual. After reading, please keep this manual handy and refer to it to enhance your enjoyment of your new camera.

## About This Manual





If you want to start using the camera right away, see “The Basics of Shooting and Playback” (📖10).

To learn about the parts of the camera and information that is displayed in the monitor, see “Parts of the Camera” (📖1).

### Other Information

- Symbols and Conventions

To make it easier to find the information you need, the following symbols and conventions are used in this manual:

Symbol	Description
	This icon indicates cautions and information that should be read before using the camera.
	This icon indicates notes and information that should be read before using the camera.
	These icons indicate other pages containing relevant information;  : “Reference Section”,  : “Technical Notes and Index.”

- SD and SDHC/SDXC memory cards are referred to as “memory cards” in this manual.
- The setting at the time of purchase is referred to as the “default setting.”
- The names of menu items displayed in the camera monitor, and the names of buttons or messages displayed on a computer monitor appear in bold.
- In this manual, images are sometimes omitted from monitor display samples so that monitor indicators can be more clearly shown.
- Illustrations and monitor content shown in this manual may differ from the actual product.

## Information and Precautions

### Life-Long Learning

As part of Nikon's "Life-Long Learning" commitment to ongoing product support and education, continually updated information is available online at the following sites:

- For users in the U.S.A.: <http://www.nikonusa.com/>
- For users in Europe and Africa: <http://www.europe-nikon.com/support/>
- For users in Asia, Oceania, and the Middle East: <http://www.nikon-asia.com/>

Visit these sites to keep up-to-date with the latest product information, tips, answers to frequently asked questions (FAQs), and general advice on digital imaging and photography. Additional information may be available from the Nikon representative in your area. Visit the site below for contact information:

<http://imaging.nikon.com/>

### Use Only Nikon Brand Electronic Accessories

Nikon COOLPIX cameras are designed to the highest standards and include complex electronic circuitry. Only Nikon brand electronic accessories (including battery chargers, batteries, charging AC adapters, AC adapters, and cables) certified by Nikon specifically for use with this Nikon digital camera are engineered and proven to operate within the operational and safety requirements of this electronic circuitry.

**THE USE OF NON-NIKON ELECTRONIC ACCESSORIES COULD DAMAGE THE CAMERA AND MAY VOID YOUR NIKON WARRANTY.**

The use of third-party rechargeable Li-ion batteries not bearing the Nikon holographic seal could interfere with normal operation of the camera or result in the batteries overheating, igniting, rupturing, or leaking.

For more information about Nikon brand accessories, contact a local authorized Nikon dealer.

**Holographic seal:** Identifies this device as an authentic Nikon product.



### Before Taking Important Pictures

Before taking pictures on important occasions (such as at weddings or before taking the camera on a trip), take a test shot to ensure that the camera is functioning normally. Nikon will not be held liable for damages or lost profits that may result from product malfunction.

## About the Manuals

- No part of the manuals included with this product may be reproduced, transmitted, transcribed, stored in a retrieval system, or translated into any language in any form, by any means, without Nikon's prior written permission.
- Nikon reserves the right to change the specifications of the hardware and software described in these manuals at any time and without prior notice.
- Nikon will not be held liable for any damages resulting from the use of this product.
- While every effort was made to ensure that the information in these manuals is accurate and complete, we would appreciate it were you to bring any errors or omissions to the attention of the Nikon representative in your area (address provided separately).

## Notice Concerning Prohibition of Copying or Reproduction

Note that simply being in possession of material that was digitally copied or reproduced by means of a scanner, digital camera or other device may be punishable by law.

### • **Items prohibited by law from being copied or reproduced**

Do not copy or reproduce paper money, coins, securities, government bonds or local government bonds, even if such copies or reproductions are stamped "Sample." The copying or reproduction of paper money, coins, or securities which are circulated in a foreign country is prohibited. Unless the prior permission of the government was obtained, the copying or reproduction of unused postage stamps or post cards issued by the government is prohibited.

The copying or reproduction of stamps issued by the government and of certified documents stipulated by law is prohibited.

### • **Cautions on certain copies and reproductions**

The government has issued cautions on copies or reproductions of securities issued by private companies (shares, bills, checks, gift certificates, etc.), commuter passes, or coupon tickets, except when a minimum of necessary copies are to be provided for business use by a company. Also, do not copy or reproduce passports issued by the government, licenses issued by public agencies and private groups, ID cards and tickets, such as passes and meal coupons.

### • **Comply with copyright notices**

The copying or reproduction of copyrighted creative works such as books, music, paintings, woodcut prints, maps, drawings, movies, and photographs is governed by national and international copyright laws. Do not use this product for the purpose of making illegal copies or to infringe copyright laws.

## Disposing of Data Storage Devices

Please note that deleting images or formatting data storage devices such as memory cards or built-in camera memory does not completely erase the original image data. Deleted files can sometimes be recovered from discarded storage devices using commercially available software, potentially resulting in the malicious use of personal image data. Ensuring the privacy of such data is the user's responsibility.

Before discarding a data storage device or transferring ownership to another person, erase all data using commercial deletion software, or set **Record location data** of **Location data options** (📖91) to **Off** after formatting the device and then completely refill it with images containing no private information (for example, pictures of empty sky). Be sure to also replace any pictures selected for the **Select an image** option in the **Welcome screen** setting (📖83). Care should be taken to avoid injury or damage to property when physically destroying data storage devices. For the COOLPIX S9700, the log data saved on the memory card is handled in the same way as other data. To erase the log data that is obtained but not stored on the memory card, select **Create log** → **End log** → **Erase log**.

You can clear the Wi-Fi settings using **Restore default settings** in the Wi-Fi options menu (📖89).



## For Your Safety

To prevent damage to your Nikon product or injury to yourself or to others, read the following safety precautions in their entirety before using this equipment. Keep these safety instructions where all those who use the product will read them.

The consequences that could result from failure to observe the precautions listed in this section are indicated by the following symbol:



This icon marks warnings, information that should be read before using this Nikon product, to prevent possible injury.

### WARNINGS

#### **Turn off in the event of malfunction**

Should you notice smoke or an unusual smell coming from the camera or charging AC adapter, unplug the charging AC adapter and remove the battery immediately, taking care to avoid burns. Continued operation could result in injury. After removing or disconnecting the power source, take the equipment to a Nikon-authorized service representative for inspection.

#### **Do not disassemble**

Touching the internal parts of the camera or charging AC adapter could result in injury. Repairs should be performed only by qualified technicians. Should the camera or charging AC adapter break open as the result of a fall or other accident, take the product to a Nikon-authorized service representative for inspection, after unplugging the product and/or removing the battery.

#### **Do not use the camera or charging AC adapter in the presence of flammable gas**

Do not use electronic equipment in the presence of flammable gas, as this could result in explosion or fire.

#### **Handle the camera strap with care**

Never place the strap around the neck of an infant or child.

#### **Keep out of reach of children**

Particular care should be taken to prevent infants from putting the battery or other small parts into their mouths.

#### **Do not remain in contact with the camera, charging AC adapter, or AC adapter for extended periods while the devices are on or in use**

Parts of the devices become hot. Leaving the devices in direct contact with the skin for extended periods may result in low-temperature burns.

**⚠ Do not leave the product where it will be exposed to extremely high temperatures, such as in an enclosed automobile or in direct sunlight**

Failure to observe this precaution could cause damage or fire.

**⚠ Use the appropriate power supply (battery, charging AC adapter, AC adapter, USB cable)**

Using a power supply other than those provided or sold by Nikon could result in damage or malfunction.

**⚠ Observe caution when handling the battery**

The battery may leak, overheat, or explode if improperly handled. Observe the following precautions when handling the battery for use in this product:

- Before replacing the battery, turn the product off. If you are using the charging AC adapter/AC adapter, be sure it is unplugged.
- Use only a Rechargeable Li-ion Battery EN-EL12 (included). Charge the battery by using a camera that supports battery charging. To perform this operation, use the Charging AC Adapter EH-71P (included) and USB Cable UC-E21 (included). The Battery Charger MH-65 (available separately) is also available to charge the battery without using a camera.
- When inserting the battery, do not attempt to insert it upside down or backwards.
- Do not short or disassemble the battery or attempt to remove or break the battery insulation or casing.

- Do not expose the battery to flame or to excessive heat.
- Do not immerse in or expose to water.
- Put the battery in a plastic bag, etc. to insulate the terminal before transporting it. Do not transport or store with metal objects such as necklaces or hairpins.
- The battery is prone to leakage when fully discharged. To avoid damage to the product, be sure to remove the battery when no charge remains.
- Discontinue use immediately should you notice any change in the battery, such as discoloration or deformation.
- If liquid from the damaged battery comes in contact with clothing or skin, rinse immediately with plenty of water.

**⚠ Observe the following precautions when handling the charging AC adapter**

- Keep dry. Failure to observe this precaution could result in fire or electric shock.
- Dust on or near the metal parts of the plug should be removed with a dry cloth. Continued use could result in fire.
- Do not handle the plug or go near the charging AC adapter during lightning storms. Failure to observe this precaution could result in electric shock.

- Do not damage, modify, forcibly tug or bend the USB cable, place it under heavy objects, or expose it to heat or flames. Should the insulation be damaged and the wires become exposed, take it to a Nikon-authorized service representative for inspection. Failure to observe these precautions could result in fire or electric shock.
- Do not handle the plug or charging AC adapter with wet hands. Failure to observe this precaution could result in electric shock.
- Do not use with travel converters or adapters designed to convert from one voltage to another or with DC-to-AC inverters. Failure to observe this precaution could damage the product or cause overheating or fire.

#### **Use appropriate cables**

When connecting cables to the input and output jacks, use only the cables provided or sold by Nikon for the purpose, to maintain compliance with product regulations.

#### **Handle moving parts with care**

Be careful that your fingers or other objects are not pinched by the lens cover or other moving parts.

#### **Using the flash close to your subject's eyes could cause temporary visual impairment**

The flash should be no less than 1 m (3 ft 4 in.) from the subject. Particular care should be observed when photographing infants.

#### **Do not operate the flash with the flash window touching a person or object**

Failure to observe this precaution could result in burns or fire.

#### **Turn the power off when using inside an airplane or the hospital**

Turn the power off while inside the airplane during take off or landing. Before boarding an airplane, set the record location data function to OFF. End log recording. Do not use wireless network functions while in the air. Follow the instructions of the hospital when using while in a hospital. The electromagnetic waves emitted by this camera may disrupt the electronic systems of the airplane or the instruments of the hospital. If you are using an Eye-Fi card, remove it from the camera before boarding an aircraft or entering a hospital.

# Notices

## Notices for Customers in the U.S.A.

### **IMPORTANT SAFETY INSTRUCTIONS -**

#### **SAVE THESE INSTRUCTIONS.**

#### **DANGER - TO REDUCE THE RISK OF FIRE OR ELECTRIC SHOCK, CAREFULLY FOLLOW THESE INSTRUCTIONS**

For connection to a supply not in the U.S.A., use an attachment plug adapter of the proper configuration for the power outlet if needed.

The power supply unit is intended to be correctly orientated in a vertical or floor mount position.

#### **Federal Communications Commission (FCC) Radio Frequency Interference Statement**

This equipment has been tested and found to comply with the limits for a Class B digital device, pursuant to Part 15 of the FCC Rules. These limits are designed to provide reasonable protection against harmful interference in a residential installation. This equipment generates, uses, and can radiate radio frequency energy and, if not installed and used in accordance with the instructions, may cause harmful interference to radio communications. However, there is no guarantee that interference will

not occur in a particular installation. If this equipment does cause harmful interference to radio or television reception, which can be determined by turning the equipment off and on, the user is encouraged to try to correct the interference by one or more of the following measures:

- Reorient or relocate the receiving antenna.
- Increase the separation between the equipment and receiver.
- Connect the equipment into an outlet on a circuit different from that to which the receiver is connected.
- Consult the dealer or an experienced radio/TV technician for help.



**Nikon**

COOLPIX S9700

### **CAUTIONS**

#### **Modifications**

The FCC requires the user to be notified that any changes or modifications made to this device that are not expressly approved by Nikon Corporation may void the user's authority to operate the equipment.

#### **Interface Cables**

Use the interface cables sold or provided by Nikon for your equipment. Using other interface cables may exceed the limits of Class B Part 15 of the FCC Rules.

## **Notice for customers in the State of California**

### **WARNING**

Handling the cord on this product will expose you to lead, a chemical known to the State of California to cause birth defects or other reproductive harm.

***Wash hands after handling.***

Nikon Inc.,

1300 Walt Whitman Road  
Melville, New York 11747-3064  
USA

Tel: 631-547-4200

## **Notice for customers in Canada**

CAN ICES-3 B / NMB-3 B

## **Notices for customers in Europe**

### **CAUTIONS**

### **RISK OF EXPLOSION IF BATTERY IS REPLACED BY AN INCORRECT TYPE.**

### **DISPOSE OF USED BATTERIES ACCORDING TO THE INSTRUCTIONS.**

This symbol indicates that electrical and electronic equipment is to be collected separately.



The following apply only to users in European countries:

- This product is designated for separate collection at an appropriate collection point. Do not dispose of as household waste.
- Separate collection and recycling helps conserve natural resources and prevent negative consequences for human health and the environment that might result from incorrect disposal.
- For more information, contact the retailer or the local authorities in charge of waste management.

This symbol on the battery indicates that the battery is to be collected separately.



The following apply only to users in European countries:

- All batteries, whether marked with this symbol or not, are designated for separate collection at an appropriate collection point. Do not dispose of as household waste.
- For more information, contact the retailer or the local authorities in charge of waste management.

# <Important> Notes About Location Data Functions (GPS/GLONASS, Electronic Compass)

## ● Map/location name data of this camera

Before using the location data functions, make sure to read "USER LICENSE AGREEMENT FOR MAP DATA AND LOCATION NAME DATA" (☞19) and agree to the terms.

- The maps and location name information (Points of Interest: POI) are as of April 2013.  
The maps and location name information will not be updated.
- The details of geological formations are displayed simplistically according to the scale of a map. The scale of a map and level of detail of the location data vary depending on country and region.  
If the latitude becomes higher, the horizontal and vertical scales displayed on the monitor vary, therefore displayed geological formations differ from the actual formations. Use the maps and location name information only as a guide.
- The detailed map data and location name information (Points of Interest: POI) of the People's Republic of China ("China") and the Republic of Korea are not provided for the COOLPIX S9700.

## ● Notes about record location data functions and log recording

- When **Record location data** in **Location data options** of the Location data options menu is set to **On** or during log recording, record location data functions and log recording function will continue to operate even after the camera is turned off (☞86).  
The electromagnetic waves emitted by this camera may disrupt the electronic systems of the airplane or the instruments of the hospital. When use of the camera is prohibited or restricted during airplane takeoffs and landings or inside a hospital, end log recording, set **Record location data** to **Off**, and then turn off the camera.
- An individual may be identified from still images or movies that have been recorded with location data. Observe caution when you transfer still images or movies recorded with location data, or log files to a third party or upload them to a network such as the Internet where the public can view them.  
Make sure to read "Disposing of Data Storage Devices" (☞vi).

## ● Notes about measurement functions

The COOLPIX S9700 is a camera. Do not use this camera as a navigation device or measuring instrument.

- Use information (such as direction) measured by the camera as a guideline only. Do not use this information for navigation of an airplane, car, and person or land survey applications.
- When you use the camera for mountain climbing or trekking, make sure to take a map, navigation device, or measuring instrument separately.

## ● Using the camera overseas

- Before taking the camera with location data functions overseas for travel, consult your travel agency or embassy of the country you are visiting to confirm whether there is any restriction on use. For example, you cannot record location data logs without permission from the government in China.

Set **Record location data** to **Off**.

- The location data may not function properly in China and on the borders between China and neighboring countries (as of December 2013).

## Wi-Fi (Wireless LAN Network)

This product is controlled by the United States Export Administration Regulations, and you are required to obtain permission from the United States government if you export or re-export this product to any country to which the United States embargoes goods. The following countries were subject to embargo: Cuba, Iran, North Korea, Sudan, and Syria. Since the target countries are subject to change, please contact the United States Department of Commerce for the latest information.

### **Restrictions on Wireless Devices**

The wireless transceiver included in this product conforms to wireless regulations in the country of sale and is not for use in other countries (products purchased in the EU or EFTA can be used anywhere within the EU and EFTA). Nikon does not accept liability for use in other countries. Users who are unsure as to the original country of sale should consult with their local Nikon service center or Nikon-authorized service representative. This restriction applies to wireless operation only and not to any other use of the product.

### **Notice for Customers in the U.S.A. and Canada**

#### **Federal Communications Commission (FCC) and Industry of Canada (IC)**

#### **Declaration of Conformity**

This device complies with Part 15 of FCC Rules and Industry Canada licence-exempt RSS standard(s). Operation is subject to the following two conditions: (1) this device may not cause interference, and (2) this device must accept any interference, including interference that may cause undesired operation of this device.

#### **FCC/IC RF Exposure Statement**

This transmitter must not be co-located or operated in conjunction with any other antenna or transmitter.

The available scientific evidence does not show that any health problems are associated with using low power wireless devices. There is no proof, however, that these low power wireless devices are absolutely safe. Low power wireless devices emit low levels of radio frequency energy (RF) in the microwave range while being used. Whereas high levels of RF can produce health effects (by heating tissue), exposure to low-level RF that does not produce heating effects causes no known adverse health effects. Many studies of low-level RF exposures have not found any biological effects. Some studies have suggested that some biological effects might occur, but such findings have not been confirmed by additional research.



COOLPIX S9700, which is equipped with a DW092 (FCC ID: EW4DW092/IC ID: 4634A-3149EC) Wireless LAN Module, has been tested and found to comply with FCC/IC radiation exposure limits set forth for an uncontrolled environment and meets the FCC radio frequency (RF) Exposure Guidelines in Supplement C to OET65 and RSS-102 of the IC radio frequency (RF) Exposure rules. Please refer to the SAR test report that was uploaded to FCC website.

### **Declaration of Conformity (Europe)**

Hereby, Nikon Corporation, declares that COOLPIX S9700 is in compliance with the essential requirements and other relevant provisions of Directive 1999/5/EC. The declaration of conformity may be consulted at [http://imaging.nikon.com/support/pdf/DoC\\_S9700.pdf](http://imaging.nikon.com/support/pdf/DoC_S9700.pdf).

### **Notice for Customers in Jamaica**

This product contains a Type Approved Module by Jamaica:  
"SMA - DW092"

## **הודעה ללקוחות במדינת ישראל**

ההתקן תואם לתקנות תדרי רדיו.

יש לנהוג באמצעי זהירות בעת השימוש באפשרויות התקשורת

- א. נקודות הגישה תהיה מיועדת אך ורק לחיבור משתמש תמצוי בחצרים מתוחמים (דוגמת בית, בית עסק, מתחם שדה תעופה, קמפוס אוניברסיטאי וכ'י
- ב. לצורך גישה לאינטרנט, נקודת הגישה תקושר מחוץ לחצרים אך ורק אל בעל רשיון למתן שירות גישה לאינטרנט (ISP, להלן-ספק אינטרנט). הקישור לספק אינטרנט יהיה אך ורק באמצעות קו תקשורת נתונים המסופק בידי בעל רשיון למתן שירותי תקשורת נתונים ;
- ג. קישור נקודת הגישה מחוץ לחצרים לצורך תקשורת נתונים ייעשה באמצעות תשתיות של בעל רשיון מתאים ובלבד שלא ייעשה שימוש בקישור כאמור לצורך העברת קול (VOICE)
- ד. לצורך שרות לצד ג' נדרש רשיון נוסף מאגף הנדסה ורישוי (משרד התקשורת).

## Precautions when Using Radio Transmissions

Always keep in mind that radio transmission or reception of data is subject to interception by third parties. Note that Nikon is not responsible for data or information leaks that may occur during data transfer.













## Personal Information Management and Disclaimer

- User information registered and configured on the product, including wireless LAN connection settings and other personal information, is susceptible to alteration and loss resulting from operational error, static electricity, accident, malfunction, repair or other handling. Always keep separate copies of important information. Nikon is not responsible for any direct or indirect damages or lost profits resulting from alteration or loss of content that is not attributable to Nikon.
- Before discarding this product or transferring it to another owner, perform **Restore default settings** in the Wi-Fi options menu (0-089) to delete all user information registered and configured with the product, including wireless LAN connection settings and other personal information.

# Table of Contents

Introduction .....	ii
Read This First .....	ii
About This Manual .....	iii
Information and Precautions .....	iv
For Your Safety .....	vii
WARNINGS .....	vii
Notices .....	x
<Important> Notes About Location Data Functions (GPS/GLONASS, Electronic Compass) .....	xii
Wi-Fi (Wireless LAN Network) .....	xiv
<hr/>	
Parts of the Camera .....	1
The Camera Body .....	1
Attaching the Camera Strap .....	3
Using Menus (the MENU Button) .....	4
The Monitor .....	6
Shooting Mode .....	6
Playback Mode .....	8
<hr/>	
The Basics of Shooting and Playback .....	10
Preparation 1 Insert the Battery .....	10
Preparation 2 Charge the Battery .....	12
Preparation 3 Insert a Memory Card .....	14
Internal Memory and Memory Cards .....	15
Preparation 4 Setting the Display Language, Date, and Time .....	16
Step 1 Turn the Camera On .....	20
Step 2 Select a Shooting Mode .....	22
Available Shooting Modes .....	23
Step 3 Frame a Picture .....	24
Using the Zoom .....	25
Step 4 Focus and Shoot .....	26
The Shutter-release Button .....	27
Step 5 Play Back Images .....	28
Step 6 Delete Images .....	29

Shooting Features.....	31
 (Auto) Mode.....	31
Scene Mode (Shooting Suited to Scenes).....	32
Tips and Notes.....	33
Smart Portrait Mode (Capturing Images of Smiling Faces).....	39
Special Effects Mode (Applying Effects When Shooting).....	41
<b>P, S, A, M</b> Modes (Setting the Exposure for Shooting).....	43
Using Quick Effects.....	44
The Control Range of the Shutter Speed.....	48
<b>Functions That Can Be Set Using the Multi Selector</b> .....	49
Using the Flash.....	50
Using the Self-timer.....	53
Using Macro Mode.....	54
Adjusting Brightness (Exposure Compensation), Vividness, and Hue (Creative Slider).....	55
Adjusting Brightness (Exposure Compensation).....	58
Default Settings.....	59
<b>Functions That Can Be Set with the MENU Button (Shooting Menu)</b> .....	61
Options Available in the Shooting Menu.....	62
<b>Functions That Cannot Be Used Simultaneously</b> .....	64
<b>Focusing</b> .....	68
Using Target Finding AF.....	68
Using Face Detection.....	69
Using Skin Softening.....	70
Subjects Not Suitable for Autofocus.....	70
Focus Lock.....	71
Playback Features.....	72
Playback Zoom.....	72
Thumbnail Playback, Calendar Display.....	73
<b>Functions That Can Be Set with the MENU Button (Playback Menu)</b> .....	74
Recording and Playing Back Movies.....	76
Recording Movies.....	76
<b>Functions That Can Be Set with the MENU Button (Movie Menu)</b> .....	80
Playing Back Movies.....	81

General Camera Setup.....	83
Functions That Can Be Set with the <b>MENU</b> Button (Setup Menu) .....	83
Using Location Data Functions/Displaying Maps .....	85
Starting Location Data Recording .....	85
Displaying Maps.....	88
When Using Shooting Mode .....	88
When Using Playback Mode.....	89
Functions That Can Be Set Using the <b>MENU</b> Button (Location Data Options Menu) .....	91
Using the Wi-Fi (Wireless LAN) Function .....	93
Functions That Can Be Performed Using Wi-Fi.....	93
Take Photos .....	93
View Photos.....	93
Installing the Software on the Smart Device .....	93
Connecting the Smart Device to the Camera.....	94
Connecting the Camera to a TV, Computer, or Printer.....	96
Connection Methods.....	96
Using ViewNX 2 .....	98
Installing ViewNX 2 .....	98
Transferring Images to the Computer .....	99
Viewing Images.....	101
<b>Reference Section .....</b>	<b> 1</b>
Using Easy Panorama (Shooting and Playback) .....	 2
Shooting with Easy Panorama.....	 2
Viewing Images Captured with Easy Panorama .....	 4
Favorite Pictures Mode.....	 5
Adding Images to Albums .....	 5
Playing Back Images in Albums .....	 6
Removing Images from Albums.....	 7
Changing the Favorites Album Icon .....	 8
Auto Sort Mode .....	 9
List by Date Mode.....	 10
Viewing and Deleting Images Captured Continuously (Sequence).....	 11

Viewing Images in a Sequence .....	11
Deleting Images in a Sequence .....	12
<b>Editing Still Images</b> .....	<b>13</b>
Before Editing Images .....	13
Quick Effects: Changing Hue or Mood .....	14
Quick Retouch: Enhancing Contrast and Saturation .....	15
D-Lighting: Enhancing Brightness and Contrast .....	15
Red-eye Correction: Correcting Red-eye When Shooting with the Flash .....	16
Glamour Retouch: Enhancing Human Faces.....	17
Small Picture: Reducing the Size of an Image .....	18
Crop: Creating a Cropped Copy .....	19
<b>Connecting the Camera to a TV (Viewing Images on a TV)</b> .....	<b>20</b>
<b>Connecting the Camera to a Printer (Direct Print)</b> .....	<b>21</b>
Connecting the Camera to a Printer .....	22
Printing Individual Images.....	23
Printing Multiple Images.....	25
<b>Editing Movies</b> .....	<b>27</b>
Extracting Only the Desired Portion of a Movie.....	27
Saving a Frame from a Movie as a Still Image.....	28
<b>The Common Shooting Options (Image Quality and Image Size)</b> .....	<b>29</b>
Image Quality .....	29
Image Size.....	30
<b>The Shooting Menu (P, S, A, or M Mode)</b> .....	<b>31</b>
White Balance (Adjusting Hue) .....	31
Metering .....	33
Continuous Shooting.....	34
ISO Sensitivity .....	37
AF Area Mode.....	38
Autofocus Mode.....	41
Quick Effects .....	41
M Exposure Preview .....	42
<b>The Smart Portrait Menu</b> .....	<b>43</b>
Skin Softening .....	43
Smile Timer .....	44
Blink Proof.....	45
<b>The Playback Menu</b> .....	<b>46</b>
Print Order (Creating a DPOF Print Order) .....	46
Slide Show .....	49
Protect.....	50
Rotate Image.....	51

Voice Memo .....	852
Copy (Copy Between Internal Memory and Memory Card).....	853
Sequence Display Options .....	854
Choose Key Picture .....	854
<b>The Movie Menu .....</b>	<b>855</b>
Movie Options.....	855
Open with HS Footage .....	859
AF Area Mode .....	859
Autofocus Mode.....	860
Movie VR.....	861
Wind Noise Reduction .....	862
Frame Rate .....	862
<b>The Setup Menu .....</b>	<b>863</b>
Welcome Screen.....	863
Time Zone and Date .....	864
Monitor Settings.....	866
Print Date (Imprinting Date and Time) .....	868
Photo VR .....	869
Motion Detection.....	870
AF Assist .....	870
Digital Zoom.....	871
Sound Settings .....	872
Auto Off .....	872
Format Memory/Format Card.....	873
Language .....	874
TV Settings.....	874
Charge by Computer.....	875
Blink Warning.....	876
Eye-Fi Upload.....	877
Reset All.....	878
Firmware Version .....	878
<b>The Location Data Options Menu.....</b>	<b>879</b>
Location Data Options.....	879
Distance Units .....	880
Calculate Distance.....	881
Points of Interest (POI) (Recording and Displaying Location Name Information).....	882
Create Log (Record the Log of Movement Information) .....	883
View Log .....	885
Set Clock from Satellite .....	886

Electronic Compass .....	87
The Wi-Fi Options Menu.....	89
Error Messages.....	91
File Names .....	96
Optional Accessories .....	97

---



---

## Technical Notes and Index..... 1

---



---



<b>Caring for the Product</b> .....	2
The Camera.....	2
The Battery .....	3
Charging AC Adapter .....	4
Memory Cards.....	5
<b>Cleaning and Storage</b> .....	6
Cleaning.....	6
Storage .....	7
<b>Troubleshooting</b> .....	8
<b>USER LICENSE AGREEMENT FOR MAP DATA AND LOCATION NAME</b>	
<b>DATA</b> .....	19
<b>Specifications</b> .....	25
Approved Memory Cards.....	29
<b>Index</b> .....	32

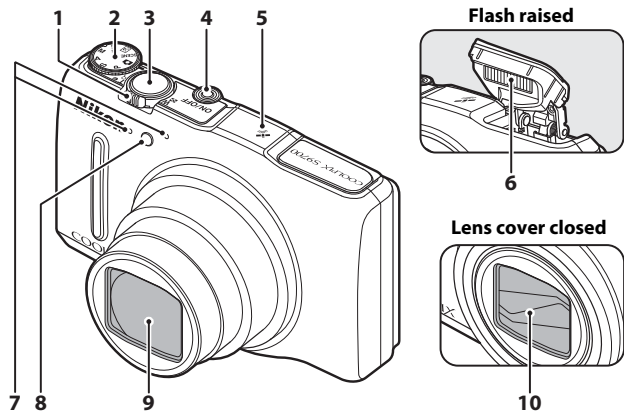

# Parts of the Camera

## The Camera Body



<b>1</b>	Zoom control.....25	<b>5</b>	Positioning antenna.....85
	<b>W</b> : wide-angle.....25	<b>6</b>	Flash.....50
	<b>T</b> : telephoto.....25	<b>7</b>	Microphone (stereo).....74, 76
	 : thumbnail playback.....73	<b>8</b>	Self-timer lamp.....53
	 : playback zoom.....72	<b>9</b>	AF-assist illuminator.....83
	 : help.....33	<b>10</b>	Lens cover
<b>2</b>	Mode dial.....22		
<b>3</b>	Shutter-release button.....26		
<b>4</b>	Power switch/power-on lamp.....20		

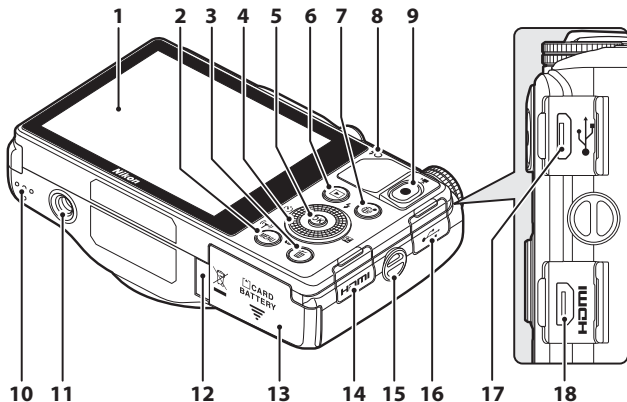

<b>1</b>	OLED monitor (monitor) <sup>1</sup> .....6, 20
<b>2</b>	<b>MENU</b> (menu) button.....4
<b>3</b>	(delete) button.....29, 82
<b>4</b>	Rotary multi selector (multi selector) <sup>2</sup> .....4
<b>5</b>	(apply selection) button .....4
<b>6</b>	(playback) button.....28
<b>7</b>	(map) button.....88
<b>8</b>	Charge lamp.....12 Flash lamp.....50
<b>9</b>	(movie-record) button .....76
<b>10</b>	Speaker .....81, 83

<b>11</b>	Tripod socket
<b>12</b>	Power connector cover (for connection with optional AC adapter).....97
<b>13</b>	Battery-chamber/ memory card slot cover ..... 10, 14
<b>14</b>	HDMI connector cover ..... 96
<b>15</b>	Eyelet for camera strap ..... 3
<b>16</b>	USB connector cover ..... 12, 96, 99
<b>17</b>	Micro-USB connector..... 12, 96, 99
<b>18</b>	HDMI micro connector (Type D) .....96

<sup>1</sup> Also referred to as the “monitor” in this manual.

<sup>2</sup> Also referred to as the “multi selector” in this manual.

## Attaching the Camera Strap

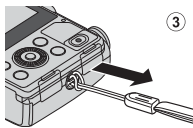
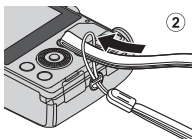
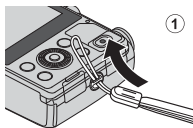

# Using Menus (the MENU Button)

Use the multi selector and **OK** button to navigate the menus.

## 1 Press the **MENU** button.

- The menu is displayed.

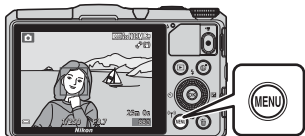

## 2 Press the multi selector **◀**.

- The current menu icon is displayed in yellow.



Menu icons

## 3 Select the desired menu icon.

- The menu is changed.
- The menu icons can also be selected by rotating the multi selector.

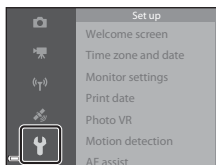

## 4 Press the **OK** button.

- The menu options become selectable.

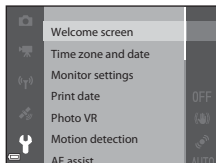

## 5 Select a menu option.

- The menu options can also be selected by rotating the multi selector.

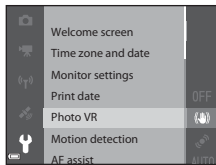

## 6 Press the **OK** button.

- The settings for the option you selected are displayed.

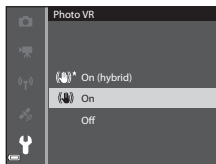

## 7 Select a setting.

- The settings can also be selected by rotating the multi selector.



## 8 Press the **OK** button.







- The setting you selected is applied.
- When you are finished using the menu, press the **MENU** button.



### Notes About Setting Menu Options

- Certain menu options cannot be set depending on the current shooting mode or the state of the camera. Unavailable options are displayed in gray and cannot be selected.
- When a menu is displayed, you can switch to shooting mode by pressing the shutter-release button or  (movie-record) button.



<b>1</b>	Shooting mode.....	22, 23	<b>25</b>	ISO sensitivity.....	62
<b>2</b>	Flash mode.....	50	<b>26</b>	(a) Battery level indicator.....	20
<b>3</b>	Macro mode.....	54	<b>26</b>	(b) Charging AC adapter connection indicator	
<b>4</b>	Zoom indicator.....	25, 54	<b>27</b>	Print date.....	83
<b>5</b>	Focus indicator.....	26	<b>28</b>	Travel destination icon.....	 65
<b>6</b>	Movie options (normal speed movies).....	80,  55	<b>29</b>	"Date not set" indicator.....	16
<b>7</b>	Movie options (HS movies) .....	80,  56	<b>30</b>	Eye-Fi communication indicator .....	84
<b>8</b>	Image quality.....	62,  29	<b>31</b>	Wi-Fi communication indicator .....	93
<b>9</b>	Image size.....	62,  30	<b>32</b>	Log display.....	91
<b>10</b>	Easy panorama.....	37	<b>33</b>	Location data reception.....	87
<b>11</b>	Vibration reduction icon.....	80, 83	<b>34</b>	White balance mode.....	62
<b>12</b>	Motion detection icon.....	83	<b>35</b>	Skin softening.....	63
<b>13</b>	Wind noise reduction.....	80	<b>36</b>	Hue.....	57
<b>14</b>	Exposure compensation value .....	56, 58	<b>37</b>	Vividness.....	57
<b>15</b>	Movie recording time remaining .....	76	<b>38</b>	Quick effects icon.....	44, 62
<b>16</b>	Number of exposures remaining (still images).....	20	<b>39</b>	Continuous shooting mode.....	62
<b>17</b>	Internal memory indicator.....	20	<b>40</b>	Blink proof icon.....	63
<b>18</b>	Aperture value.....	27, 43	<b>41</b>	Hand-held/tripod.....	34, 35
<b>19</b>	Focus area (target finding AF) .....	62, 68	<b>42</b>	Backlighting (HDR).....	36
<b>20</b>	Focus area (for manual or center) .....	62, 71	<b>43</b>	Self-timer indicator.....	53
<b>21</b>	Focus area (face detection, pet detection).....	38, 39, 62, 69	<b>44</b>	Smile timer.....	63
<b>22</b>	Focus area (subject tracking) .....	62,  40	<b>45</b>	Pet portrait auto release.....	38
<b>23</b>	Center-weighted area.....	62		Compass display.....	92
<b>24</b>	Shutter speed.....	27, 43	<b>46</b>	(a) Direction gauge (b) Compass	
			<b>47</b>	Location name information (POI information).....	87
			<b>48</b>	Exposure indicator.....	46

# Playback Mode

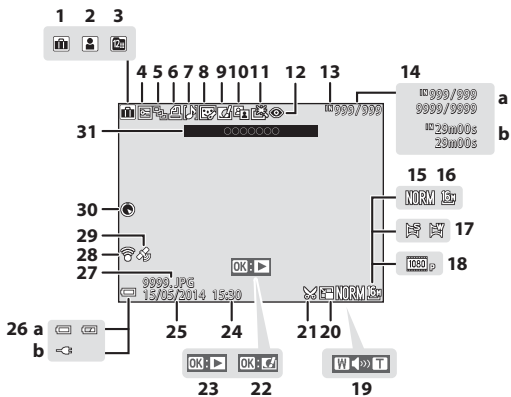



1	Album icon in favorite pictures mode.....	5
2	Category icon in auto sort mode .....	9
3	List by date icon.....	10
4	Protect icon.....	74, 50
5	Sequence display (when <b>Individual pictures</b> is selected) .....	75, 54
6	Print order icon.....	74, 46
7	Voice memo indicator....	74, 52
8	Glamour retouch icon....	74, 17
9	Quick effects icon.....	28, 44, 14
10	D-Lighting icon.....	74, 15
11	Quick retouch icon.....	74, 15
12	Red-eye correction.....	74, 16
13	Internal memory indicator.....	20
14	(a) Current image number/ total number of images (b) Movie length	
15	Image quality .....	62, 29
16	Image size .....	62, 30
17	Easy panorama.....	37
18	Movie options .....	80, 55
19	Volume indicator .....	81, 52
20	Small picture icon .....	74, 18
21	Crop icon.....	72, 19
22	Quick effects guide .....	28
23	Easy panorama playback guide .....	37, 4
	Sequence playback guide .....	75, 11
	Movie playback guide .....	81
24	Time of recording	
25	Date of recording	
26	(a) Battery level indicator .....	20
	(b) Charging AC adapter connection indicator	
27	File number and type.....	96
28	Eye-Fi communication indicator .....	84, 77
29	Recorded location data indicator .....	87
30	Compass display (compass).....	92
31	Location name information (POI information).....	87

# The Basics of Shooting and Playback

## Preparation 1 Insert the Battery

- 1** Open the battery-chamber/  
memory card slot cover.

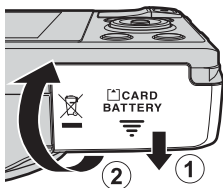

- 2** Insert the battery.

- Push the orange battery latch in the direction indicated by the arrow (1), and fully insert the battery (2).
- The battery locks into place when inserted correctly.

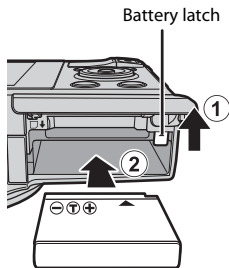

- ✓ Be Careful to Insert the Battery in Correct Direction**

*Inserting the battery upside down or backwards could damage the camera.*



- 3** Close the battery-chamber/  
memory card slot cover.

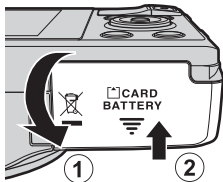

## Removing the Battery

Turn the camera off and make sure that the power-on lamp and the monitor have turned off, and then open the battery-chamber/memory card slot cover.

Move the battery latch in the direction indicated by the arrow (①) to eject the battery (②).

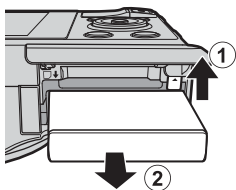

### High Temperature Caution

The camera, battery, and memory card may be hot immediately after using the camera.

## Preparation 2 Charge the Battery

### 1 Prepare the included charging AC adapter.

If a plug adapter\* is included with your camera, attach the plug adapter to the plug on the charging AC adapter. Push the plug adapter firmly until it is securely held in place. Once the two are connected, attempting to forcibly remove the plug adapter could damage the product.

\* The shape of the plug adapter varies according to the country or region in which the camera was purchased.

This step can be omitted if the plug adapter comes permanently bonded to the charging AC adapter.

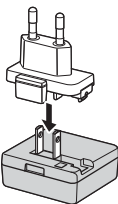
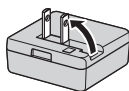

### 2 Make sure the battery is installed in the camera, and then connect the camera to the charging AC adapter in order of ① to ③.

- Keep the camera turned off.
- Make sure that the plugs are properly oriented. Do not insert or remove the plugs at an angle when connecting or disconnecting them.

#### ✓ Notes

Do not use a USB cable other than the UC-E21. Using a USB cable other than the UC-E21 could result in overheating, fire or electric shock.

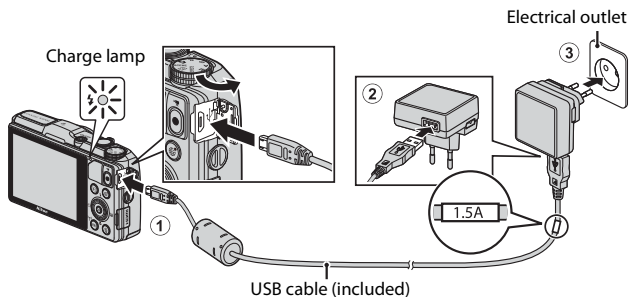

- The charge lamp slowly flashes green to indicate that the battery is charging.



Charge lamp	Description
Flashes slowly (green)	The battery is charging.
Off	When charging is complete, the charge lamp stops flashing green and turns off. About 2 hours and 20 minutes are required to charge a fully exhausted battery.
Flashes quickly (green)	<ul style="list-style-type: none"> <li>The ambient temperature is not suited to charging. Charge the battery indoors with an ambient temperature of 5°C to 35°C (41°F to 95°F).</li> <li>The USB cable or charging AC adapter is not properly connected, or there is a problem with the battery. Disconnect the USB cable or unplug the charging AC adapter and correctly connect it again, or change the battery.</li> </ul>

### 3 Disconnect the charging AC adapter from the electrical outlet and then disconnect the USB cable.

#### Notes About Charging

Do not, under any circumstances, use another make or model of AC adapter other than Charging AC Adapter EH-71P, and do not use a commercially available USB-AC adapter or a battery charger for a mobile phone. Failure to observe this precaution could result in overheating or in damage to the camera.

#### Charging Using a Computer or Battery Charger

- You can also charge the battery by connecting the camera to a computer ( 96,  75).
- You can use the Battery Charger MH-65 (available separately;  97) to charge the battery without using the camera.

## Preparation 3 Insert a Memory Card

- 1 Turn off the camera and open the battery-chamber/memory card slot cover.

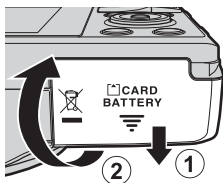

- 2 Insert the memory card.

- Slide the memory card in until it clicks into place.

Memory card slot

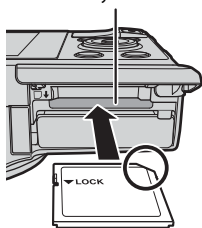

- ✓ **Be Careful to Insert the Memory Card in Correct Direction**

*Inserting the memory card upside down or backwards could damage the camera and the memory card.*



- 3 Close the battery-chamber/memory card slot cover.

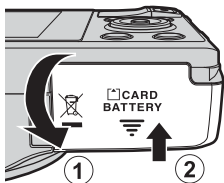

- ✓ **Formatting Memory Cards**

The first time you insert a memory card that has been used in another device into this camera, make sure to format it with this camera. Insert the card into the camera, press the **MENU** button, and select **Format card** in the setup menu.

## Removing Memory Cards

Turn the camera off and make sure that the power-on lamp and the monitor have turned off, and then open the battery-chamber/memory card slot cover.

Gently push the memory card into the camera (①) to partially eject the card (②).

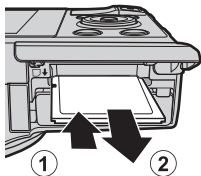

### **✓ High Temperature Caution**

The camera, battery, and memory card may be hot immediately after using the camera.

## Internal Memory and Memory Cards

Camera data, including images and movies, can be saved either in the camera's internal memory or on a memory card. To use the camera's internal memory, first remove the memory card.



## Preparation 4 Setting the Display Language, Date, and Time

When the camera is turned on for the first time, the language-selection screen and the date and time setting screen for the camera clock are displayed.

- If you exit without setting the date and time,  will flash when the shooting screen is displayed.

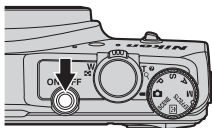
- 1** Press the power switch to turn on the camera.



- 2** Use the multi selector   to select the desired language and press the  button.

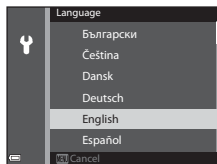

- 3** Select **Yes** and press the  button.

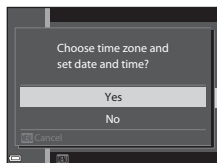



#### 4 Select your home time zone and press the **OK** button.

- To enable daylight saving time, press **▲**. When the daylight saving time function is enabled,  is displayed above the map.

To turn off the daylight saving time function, press **▼**.

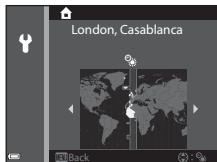

#### 5 Select the date format and press the **OK** button.

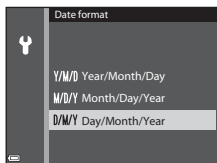

#### 6 Set the date and time, and press the **OK** button.

- Select a field: Press **◀▶** (changes between **D**, **M**, **Y**, **h**, and **m**).
- Edit the date and time: Press **▲▼**.  
Date and time can also be changed by rotating the multi selector.
- Confirm the setting: Select the **m** field and press the **OK** button.

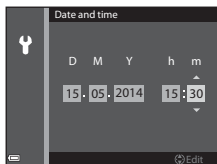

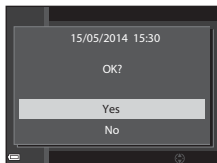

#### 7 Select **Yes** and press the **OK** button.

- When settings are finished, the lens extends and the camera switches to shooting mode.





## Changing the Language Setting and the Date and Time Setting

- You can change these settings using the **Language** and **Time zone and date** settings in the  setup menu (83).
- You can enable or disable daylight saving time in the  setup menu by selecting **Time zone and date** followed by **Time zone**. Enabling daylight saving time moves the clock forward one hour, and disabling it moves the clock back one hour.

## The Clock Battery

- The camera's clock is powered by a built-in backup battery. The backup battery charges when the main battery is inserted into the camera or when the camera is connected to an optional AC adapter, and it can run the clock for several days after about 10 hours of charging.
- If the camera's backup battery becomes exhausted, the date and time setting screen is displayed when the camera is turned on. Set the date and time again. See step 3 (16) of "Preparation 4 Setting the Display Language, Date, and Time" for more information.

## Imprinting the Shooting Date on Printed Images

- You can permanently imprint the shooting date on images as they are captured by setting **Print date** in the setup menu (83).
- If you want the shooting date to be printed without using the **Print date** setting, print using the ViewNX 2 software (98).



A series of horizontal dashed lines spanning the width of the page, intended for handwriting practice.

# Step 1 Turn the Camera On

## 1 Press the power switch.

- The monitor turns on.
- To turn the camera off, press the power switch again.
- Note that the power switch is enabled a few seconds after the battery is inserted. Wait a few seconds before pressing the power switch.

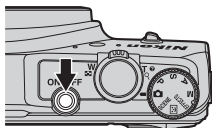

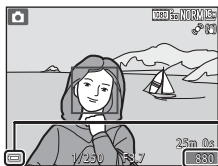

## 2 Check the battery level indicator and the number of exposures remaining.



Battery level indicator

Number of exposures remaining

### Battery level indicator

Display	Description
	The battery level is high.
	The battery level is low.
 Battery exhausted.	The camera cannot capture images. Recharge the battery.





### Number of Exposures Remaining

The number of images that can be taken is displayed.

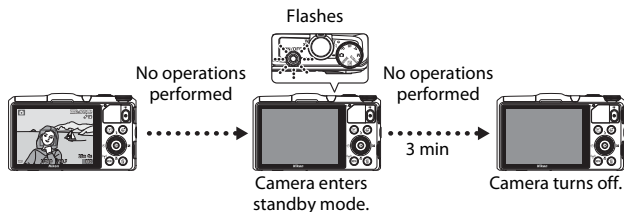
- **IN** is displayed when no memory card is inserted in the camera, and images are saved in the internal memory.



## The Auto Off Function



- The time that elapses before the camera enters standby mode is about 1 minute. The time can be changed using the **Auto off** setting in the setup menu (83).
- While the camera is in standby mode, the monitor turns back on if you perform any of the following operations:
  - Press the power switch, shutter-release button,  button, or  (movie-record) button.
  - Rotate the mode dial.
- While the charging AC adapter is connected to the camera, the monitor turns back on if you press the power switch. The camera turns off if you operate the shutter-release button, mode dial,  button, or  (movie-record) button.





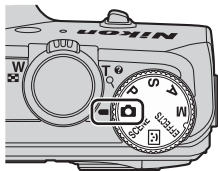

## Step 2 Select a Shooting Mode

Rotate the mode dial to select a shooting mode.

-  (auto) mode is used in this example.  
Rotate the mode dial to .



## Available Shooting Modes

	<b>Auto mode</b>	 31
	Used for general shooting.	
<b>SCENE</b>	<b>Scene mode</b>	 32
	Camera settings are optimized according to the scene that you select. When using scene auto selector, the camera automatically selects the optimum scene mode when you frame an image, making it even easier to take images using settings that suit the scene.	
	<b>Smart portrait</b>	 39
	The camera detects smiling faces and releases the shutter automatically.	
<b>EFFECTS</b>	<b>Special effects</b>	 41
	Effects can be applied to images during shooting.	
<b>P, S, A, M</b>	<b>modes</b>	 43
	Select these modes for greater control over shutter speed and aperture value.	

## Step 3 Frame a Picture

### 1 Hold the camera steady.

- Keep fingers and other objects away from the lens, flash, AF-assist illuminator, microphones, and speaker.
- When taking pictures in portrait (“tall”) orientation, turn the camera so that the flash is above the lens.

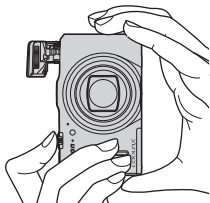
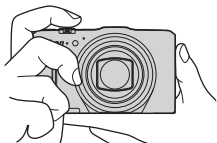

### 2 Frame the picture.



#### When Using a Tripod

- We recommend using a tripod to stabilize the camera in the following situations.
  - When shooting in dim lighting
  - When shooting with the flash mode (📖52) set to  (off)
  - When using the telephoto setting
- When using a tripod to stabilize the camera during shooting, set **Photo VR** to **Off** in the setup menu (📖83) to prevent potential errors caused by this function.



## Using the Zoom

When you move the zoom control, the zoom lens position changes.

- To zoom in closer to the subject: Move toward **T** (telephoto)
- To zoom out and view a larger area: Move toward **W** (wide-angle)

When you turn the camera on, the zoom moves to the maximum wide-angle position.

- A zoom indicator is displayed at the top of the shooting screen when the zoom control is moved.
- Digital zoom, which allows you to further magnify the subject up to approximately 4× the maximum optical zoom ratio, can be activated by moving and holding the zoom control toward **T** when the camera is zoomed in to the maximum optical zoom position.

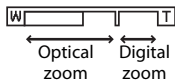
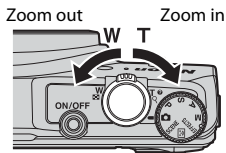

### Notes About Digital Zoom

The zoom indicator turns blue when the digital zoom is activated, and it turns yellow when the zoom magnification is increased further.

- Zoom indicator is blue: Image quality is not noticeably reduced by using the Dynamic Fine Zoom.
- Zoom indicator is yellow: Image quality is noticeably reduced.
- The indicator remains blue across a wider area when the image size is smaller.

## Step 4 Focus and Shoot

### 1 Press the shutter-release button halfway.

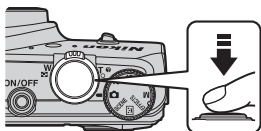

- When the subject is in focus, the focus area that includes the subject or focus indicator (📖7) glows green (multiple focus areas can glow green).
- When you are using digital zoom, the camera focuses on the subject in the center of the frame and the focus area is not displayed. When the camera has focused, the focus indicator (📖7) glows green.
- If the focus area or focus indicator flashes red, the camera is unable to focus. Modify the composition and try pressing the shutter-release button halfway again.



### 2 Without lifting your finger, press the shutter-release button the rest of the way down.



## The Shutter-release Button

<p>Press halfway</p> 	<p>To set focus and exposure (shutter speed and aperture value), press the shutter-release button lightly until you feel a slight resistance. Focus and exposure remain locked while the shutter-release button is pressed halfway.</p>
<p>Press all the way</p> 	<p>Press the shutter-release button all the way to release the shutter and take an image. Do not use force when pressing the shutter-release button, as this may result in camera shake and blurred images. Press the button gently.</p>

### ✓ Notes About Saving Images and Recording Movies

The indicator showing the number of exposures remaining or the indicator showing the maximum movie length flashes while images are being saved or while a movie is being recorded. **Do not open the battery-chamber/memory card slot cover or remove the battery or memory card** while an indicator is flashing. Doing this could result in loss of data, or in damage to the camera or the memory card.

### 📌 Flash

- If the subject is dimly lit, the flash will pop up automatically when you press the shutter-release button halfway when the flash mode is set to **⚡ AUTO** (auto; default setting). The flash will fire when you press the shutter-release button all the way. See “Using the Flash” (📖50) for more information.
- Lower the flash by gently pushing it down. When not taking images, lower the flash.

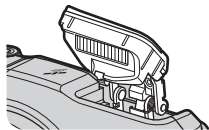



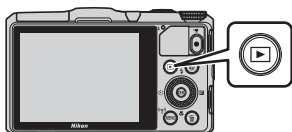

## Step 5 Play Back Images

### 1 Press the (playback) button.

- If you press and hold down the  (playback) button while the camera is turned off, the camera turns on in playback mode.



### 2 Use the multi selector to select an image to display.

- Press and hold down     to scroll through the images quickly.
- Images can also be selected by rotating the multi selector.
- To return to shooting mode, press the  button or shutter-release button.







Display the previous image



Display the next image



### Notes About the Quick Effects Function

- When  is displayed in full-frame playback mode, you can press the  button to apply an effect to the image.
- When the effect selection screen is displayed, use the multi selector   or rotate it to select an effect, press the  button, and then select **Yes** in the confirmation dialog and press the  button to save the image as a separate file. See “Quick Effects: Changing Hue or Mood” ( 14) for more information.





## Step 6 Delete Images

- 1** Press the  button to delete the image currently displayed in the monitor.

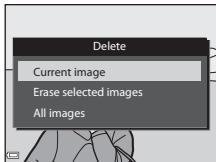

- 2** Use the multi selector   to select the desired deletion method and press the  button.
- To exit without deleting, press the **MENU** button.



- 3** Select **Yes** and press the  button.
- Deleted images cannot be recovered.
  - To cancel, select **No** and press the  button.

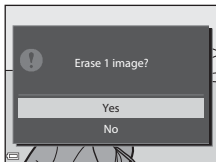

## Operating the Erase Selected Images Screen

**1** Use the multi selector ◀▶ to select an image to be deleted, and then use ▲ to display 🗑️.

- To undo the selection, press ▼ to remove 🗑️.
- Move the zoom control (📖1) toward T (🔍) to switch to full-frame playback or W (🖼️) to switch to thumbnail playback.



**2** Add 🗑️ to all images that you want to delete and then press the OK button to confirm the selection.

- A confirmation dialog is displayed. Follow the instructions displayed in the monitor.

### ✓ Deleting Images in a Sequence

- If you press the 🗑️ button and delete a key picture while only key pictures are displayed for sequences of images (📖75), all images in the sequence, including the key picture, are deleted.
- To delete individual images in a sequence, press the OK button to display them one at a time and press the 🗑️ button.

### 📎 Deleting the Last Image Captured While in Shooting Mode

When using shooting mode, press the 🗑️ button to delete the last image that was saved.

# Shooting Features

## (Auto) Mode

Used for general shooting.

- When the camera detects the main subject, a yellow border (focus area) is displayed around it (Target finding AF (📖68)).

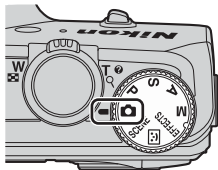

## Functions Available in (Auto) Mode

- Flash mode (📖50)
- Self-timer (📖53)
- Macro mode (📖54)
- Exposure compensation (📖58)
- Shooting menu (📖61)

## Scene Mode (Shooting Suited to Scenes)

When a scene is selected, camera settings are automatically optimized for the selected scene.

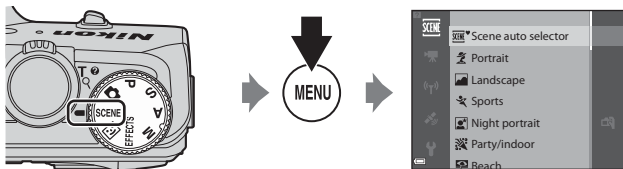

Press the **MENU** button to display the scene menu and select a scene using the multi selector.

Scene auto selector (default setting) (📖33)	Night landscape (📖35) <sup>1</sup>
Portrait	Close-up (📖35)
Landscape <sup>1</sup>	Food (📖35)
Sports (📖34) <sup>2</sup>	Museum (📖36) <sup>2</sup>
Night portrait (📖34)	Fireworks show (📖36) <sup>1, 3</sup>
Party/indoor (📖34) <sup>2</sup>	Black and white copy (📖36) <sup>2</sup>
Beach <sup>2</sup>	Backlighting (📖36) <sup>2</sup>
Snow <sup>2</sup>	Easy panorama (📖37)
Sunset <sup>2, 3</sup>	Pet portrait (📖38)
Dusk/dawn <sup>1, 3</sup>	



<sup>1</sup> The camera focuses at infinity.

<sup>2</sup> The camera focuses on the area in the center of the frame.

<sup>3</sup> Use of a tripod is recommended because the shutter speed is slow. Set **Photo VR** to **Off** in the setup menu (📖83) when using a tripod to stabilize the camera during shooting.













## To View a Description (Help Display) of Each Scene



Select a scene and move the zoom control () toward **T** () to view a description of that scene. To return to the original screen, move the zoom control toward **T** () again.

## Tips and Notes

### Scene auto selector

- When you point the camera at the subject, the camera automatically selects the optimum scene mode from the list below and adjusts the shooting settings accordingly.



	Portrait (for taking close-up portraits of one or two people)
	Portrait (for taking portraits of three or more people, or framing images with a large background size)
	Landscape
	Night portrait (for taking close-up portraits of one or two people)
	Night portrait (for taking portraits of three or more people, or framing images with a large background size)
	Night landscape
	Close-up
	Backlighting (for taking images of subjects other than people)
	Backlighting (for taking portrait images)
	Other scenes

- The focus area depends on the composition of the image. When the camera detects a human face, it focuses on that face ()69).
- In some shooting conditions, the camera may not select the appropriate scene mode that you intended. If this happens, switch to  (auto) mode or select the scene mode that you want to use when taking images ()22).

## Sports

- While the shutter-release button is held all the way down, the camera shoots up to about 5 images continuously at a rate of about 6.9 fps (when image quality is set to **Normal** and when image size is set to  **4608×3456**).
- The frame rate for continuous shooting may become slow depending upon the current image quality setting, image size setting, the memory card used, or shooting condition.
- Focus, exposure, and hue are fixed at the values determined with the first image in each series.



## Night portrait

- From the screen displayed after  **Night portrait** is selected, select **Hand-held** or **Tripod**.
- **Hand-held** (default setting):
  - When the  icon at the top left of the monitor glows green, press the shutter-release button all the way to capture a series of images which are combined into a single image and saved.
  - Once the shutter-release button is pressed all the way, hold the camera still until a still image is displayed. After taking an image, do not turn the camera off before the monitor switches to the shooting screen.
  - If the subject moves while the camera is shooting continuously, the image may be distorted, overlapped, or blurred.
- **Tripod**:
  - One image is captured at a slow shutter speed when the shutter-release button is pressed all the way.
  - Vibration reduction is disabled regardless of the **Photo VR** ( 83) setting in the setup menu.



## Party/indoor

- To avoid the effects of camera shake, hold the camera steady. Set **Photo VR** to **Off** in the setup menu ( 83) when using a tripod to stabilize the camera during shooting.





## Night landscape

- From the screen displayed after  **Night landscape** is selected, select **Hand-held** or **Tripod**.
- **Hand-held** (default setting):
  - When the  icon at the top left of the monitor glows green, press the shutter-release button all the way to capture a series of images which are combined into a single image and saved.
  - Once the shutter-release button is pressed all the way, hold the camera still until a still image is displayed. After taking an image, do not turn the camera off before the monitor switches to the shooting screen.
  - The angle of view (i.e., the area visible in the frame) seen in the saved image is narrower than that seen in the monitor at the time of shooting.
- **Tripod:**
  - One image is captured at a slow shutter speed when the shutter-release button is pressed all the way.
  - Vibration reduction is disabled regardless of the **Photo VR** (📖83) setting in the setup menu.

## Close-up

- Macro mode (📖54) is enabled and the camera automatically zooms to the closest position at which it can focus.
- You can move the focus area. Press the  button, use the multi selector  or rotate it to move the focus area, and press the  button to apply the setting.

## Food

- Macro mode (📖54) is enabled and the camera automatically zooms to the closest position at which it can focus.
- You can adjust hue by using the multi selector . The hue setting is saved in the camera's memory even after the camera is turned off.
- You can move the focus area. Press the  button, use the multi selector  or rotate it to move the focus area, and press the  button to apply the setting.



## Museum

- The camera captures a series of up to 10 images while the shutter-release button is held all the way down, and the sharpest image in the series is automatically selected and saved (BSS (Best Shot Selector)).
- The flash does not fire.



## Fireworks show

- The shutter speed is fixed at about 4 seconds.
- The zoom is restricted to 10 fixed positions.



## Black and white copy

- Use together with macro mode ( 54) when shooting subjects that are close to the camera.

## Backlighting

- From the screen displayed after  **Backlighting** is selected, select **On** or **Off** of **HDR** (high dynamic range) composition based on the type of image you want to take.
- **Off** (default setting): The flash fires to prevent the subject from being hidden in shadow.
  - When the shutter-release button is pressed all the way down, one image is captured.
- **On**: Use when taking images with very bright and dark areas in the same frame.
  - When the shutter-release button is pressed all the way, the camera shoots images continuously at high speed, and saves the following two images.
    - A non-HDR composite image
    - An HDR composite image in which the loss of details in highlights or shadows is minimized
  - If there is only enough memory to save one image, an image processed by D-Lighting ( 74) at the time of shooting, in which dark areas of the image are corrected, is the only image saved.
  - Once the shutter-release button is pressed all the way, hold the camera still until a still image is displayed. After taking an image, do not turn the camera off before the monitor switches to the shooting screen.
  - The angle of view (i.e., the area visible in the frame) seen in the saved image is narrower than that seen in the monitor at the time of shooting.

## Easy panorama

- From the screen displayed after  **Easy panorama** is selected, select the shooting range from **Normal (180°)** or **Wide (360°)**.
- The zoom position is fixed at wide-angle.
- Press the shutter-release button all the way down, remove your finger from the button, and then slowly pan the camera horizontally. Shooting ends when the camera captures the specified shooting range.
- Focus and exposure are locked when shooting starts.
- If you press the  button when a captured image is displayed in full-frame playback mode, the image scrolls automatically.
- You cannot use any image editing functions other than cropping for images captured with easy panorama on this camera.

See “Using Easy Panorama (Shooting and Playback)” (2) for more information.



### **Notes About Printing Panorama Images**

The entire image may not be able to be printed depending on the printer's settings. Additionally, printing may not be possible depending on the printer.

## Pet portrait

- When you point the camera at a dog or cat, the camera detects the pet's face and focuses on it. By default, the shutter is automatically released when the camera detects a dog or cat face (pet portrait auto release).
- From the screen displayed after  **Pet portrait** is selected, select **Single** or **Continuous**.
  - **Single**: Whenever the camera detects a dog or cat face, the camera captures 1 image.
  - **Continuous**: Whenever the camera detects a dog or cat face, the camera captures 3 images continuously.

### **Pet Portrait Auto Release**

- Press the multi selector  to change the **Pet portrait auto release** settings.
  - : When the camera detects a dog or cat face, the camera automatically releases the shutter.
  - **OFF**: The camera does not release the shutter automatically, even if a dog or cat face is detected. Press the shutter-release button. The camera also detects human faces when **OFF** is selected.
- **Pet portrait auto release** is set to **OFF** after five bursts have been taken.
- Shooting is also possible by pressing the shutter-release button, regardless of the **Pet portrait auto release** setting.

### **Focus Area**

- When the camera detects a face, the face is displayed inside a yellow border. When the camera acquires focus on a face displayed inside a double border (focus area), the double border turns green. If no faces are detected, the camera focuses on the subject in the center of the frame.
- In some shooting conditions, the pet face may not be detected and other subjects may be displayed inside a border.

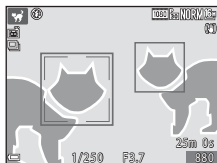

## Smart Portrait Mode (Capturing Images of Smiling Faces)

When the camera detects a smiling face, you can take an image automatically without pressing the shutter-release button (smile timer (📖63)). You can use the skin softening option to smooth the skin tones of human faces.

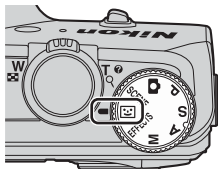

### 1 Frame the picture.

- Point the camera at a human face.

### 2 Without pressing the shutter-release button, wait for the subject to smile.

- If the camera detects that the face framed by the double border is smiling, the shutter is automatically released.
- Whenever the camera detects a smiling face, it automatically releases the shutter.

### 3 End automatic shooting.

- Perform one of the operations listed below to end shooting.
  - Set **Smile timer** to **Off**.
  - Rotate the mode dial to switch to a shooting mode other than 📷 (smart portrait) mode.
  - Turn off the camera.





### 📌 Notes About Smart Portrait Mode

Under some shooting conditions, the camera may be unable to detect faces or detect smiles (📖69). The shutter-release button can also be used for shooting.

## **When the Self-timer Lamp Flashes**

When using smile timer, the self-timer lamp flashes when the camera detects a face and flashes quickly immediately after the shutter is released.

## **Functions Available in Smart Portrait Mode**

- Flash mode ( 50)
- Self-timer ( 53)
- Exposure compensation ( 58)
- Shooting menu ( 61)



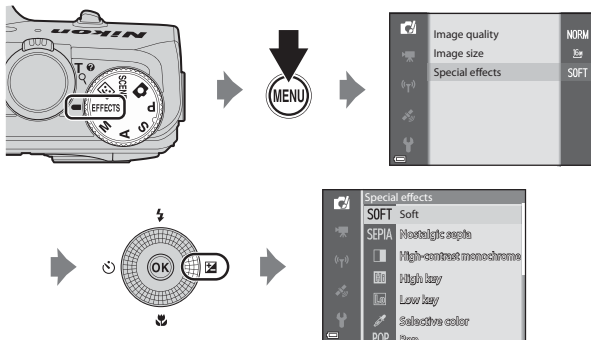

## Special Effects Mode (Applying Effects When Shooting)

Effects can be applied to images during shooting.







Press the **MENU** button to display the special effects menu and select an effect using the multi selector.

Category	Description
<b>SOFT</b> Soft (default setting)	Softens the image by adding a slight blur to the entire image.
<b>SEPIA</b> Nostalgic sepia	Adds a sepia tone and reduces the contrast to simulate the qualities of an old photograph.
High-contrast monochrome	Changes the image to black and white and gives it sharp contrast.
High key	Gives the entire image a bright tone.
Low key	Gives the entire image a dark tone.
Selective color	Creates a black and white image in which only the specified color remains.
<b>POP</b> Pop	Increases the color saturation of the entire image to create a bright look.
<b>VI</b> Super vivid	Increases the color saturation of the entire image and sharpens the contrast.

Category	Description
 Cross process	Gives the image a mysterious appearance based on a specific color.
 Toy camera effect 1	Gives the entire image a yellowish hue and darkens the image periphery.
 Toy camera effect 2	Decreases the color saturation of the entire image and darkens the image periphery.

- The camera focuses on the area in the center of the frame.
- When **Selective color** or **Cross process** is selected, use the multi selector ▲▼ to select the desired color from the slider.

To change settings for any of the following functions, press the  button to end color selection.

- Flash mode ( 50)
- Self-timer ( 53)
- Macro mode ( 54)
- Exposure compensation ( 58)

To return to the color selection screen, press the  button again.

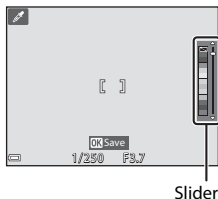

Slider

# P, S, A, M Modes (Setting the Exposure for Shooting)

Images can be shot with greater control by setting the shutter speed or aperture value manually. Settings can also be adjusted to suit the shooting conditions and the type of shot you want to capture.

- You can change how the camera selects the area of the frame to focus on by changing the **AF area mode** setting (📖62).

The default setting is **Target finding AF** (📖68).

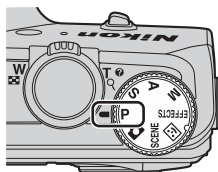

Rotate the multi selector to set the shutter speed and aperture value.



Multi selector

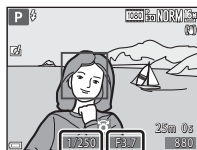

Shutter speed

Aperture value

Exposure mode	Shutter speed (📖48)	Aperture value (📖45)
<b>P</b> Programmed auto (📖46)	Automatically adjusted (flexible program is enabled by the multi selector).	
<b>S</b> Shutter-priority auto (📖46)	Adjusted by the multi selector.	Automatically adjusted.
<b>A</b> Aperture-priority auto (📖46)	Automatically adjusted.	Adjusted by the multi selector.
<b>M</b> Manual (📖46)	Adjusted by the multi selector when the shutter speed is selected using	Adjusted by the multi selector when the aperture value is selected using

## Using Quick Effects

When in **P**, **S**, **A**, or **M** mode, you can apply effects to images immediately after releasing the shutter.

- The edited image is saved as a separate file with a different name.

### 1 Press the **OK** button when the image is displayed after it is taken in **P**, **S**, **A**, or **M** mode.

- When you press the **MENU** button or when no operations are performed for about 5 seconds, the monitor display returns to the shooting screen.
- To not display the screen shown on the right, set **Quick effects** to **Off** in the shooting menu (📖61).

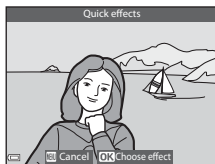

### 2 Use the multi selector **◀▶** or rotate it to select the desired effect and press the **OK** button.

- Move the zoom control (📖1) toward **T** (📖) to display a confirmation dialog for the applied effect. Move the zoom control toward **W** (📖) to return to the selection screen for effects.
- To exit without saving the edited image, press the **MENU** button. When a confirmation dialog is displayed, select **Yes** and press the **OK** button.
- See “Quick Effects: Changing Hue or Mood” (📖14) for information about the effect types.

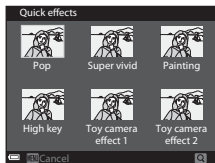

### 3 Select **Yes** and press the **OK** button.

## Exposure

The procedure for shooting images at the desired brightness (exposure) by adjusting the shutter speed or aperture value is called “determine exposure”. The sense of dynamism and amount of background defocus in images to be shot vary depending on the combinations of shutter speed and aperture value even if the exposure is the same.

### Adjusting the Shutter Speed

In **S** and **M** modes, the range is from a maximum of 1/2000 to 8 seconds. See “The Control Range of the Shutter Speed” (📖48) for more information.



Faster 1/1000 s



Slower 1/30 s

### Adjusting the Aperture Value

In **A** and **M** modes, the range is from f/3.7 to 8 (wide-angle position) and from f/6.4 to 8 (telephoto zoom position).



Larger aperture (Small f-number)  
f/3.7



Smaller aperture (Large f-number)  
f/8

### Aperture Value (F-number) and Zoom

Large apertures (expressed by small f-numbers) let more light into the camera, and small apertures (large f-numbers) let less light.

The aperture value of the zoom lens of this camera changes depending on the zoom position. When zooming to the wide-angle position and telephoto zoom position, the aperture values are f/3.7 and f/6.4, respectively.

## P (Programmed auto)

Use for automatic control of the exposure by the camera.

- Different combinations of shutter speed and aperture value can be selected without changing the exposure by rotating the multi selector (“flexible program”). While flexible program is in effect, a flexible program mark (✳) is displayed next to the mode indicator (P) in the upper left of the monitor.
- To cancel flexible program, rotate the multi selector until the flexible program mark (✳) is no longer displayed. Selecting another shooting mode, or turning off the camera, also cancels flexible program.

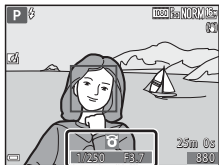

## S (Shutter-priority auto)

Use to shoot fast moving subjects at a fast shutter speed, or use to emphasize the movements of a moving subject at a slow shutter speed.

- The shutter speed can be adjusted by rotating the multi selector.

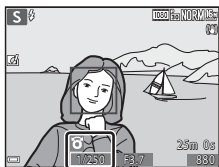

## A (Aperture-priority auto)

Use to bring subjects including both the foreground and background into focus or blur the subject's background intentionally.

- The aperture value can be adjusted by rotating the multi selector.

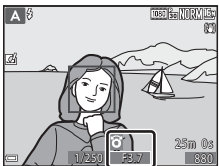

## M (Manual)

Use to control the exposure according to shooting requirements.

- When adjusting the aperture value or shutter speed, the degree of deviation from the exposure value measured by the camera is displayed in the exposure indicator of the monitor. The degree of deviation in the exposure indicator is displayed in EVs (-2 to +2 EV in increments of 1/3 EV).
- Use the multi selector ► to select the shutter speed or aperture value and rotate the multi selector to adjust either of them.

Exposure indicator

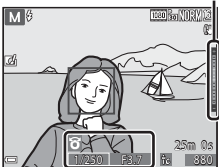

## ✓ Notes About Shooting

- When zooming is performed after the exposure is set, exposure combinations or aperture value may be changed.
- When the subject is too dark or too bright, it may not be possible to obtain the appropriate exposure. In such cases, the shutter speed indicator or aperture value indicator flashes (in **P**, **S**, and **A** modes), or the exposure indicator is displayed in red (in **M** mode) when the shutter-release button is pressed halfway. Change the shutter speed setting or aperture value.

## ✓ Notes About ISO Sensitivity



When **ISO sensitivity** (📖62) is set to **Auto** (default setting), **ISO 125-400** or **ISO 125-800**, the ISO sensitivity in **M** mode is fixed at ISO 125.

## Functions Available in P, S, A, M Modes

- Flash mode (📖50)
- Self-timer (📖53)
- Macro mode (📖54)
- Creative slider (📖55)
- Shooting menu (📖62)

## The Control Range of the Shutter Speed

The control range of the shutter speed differs depending on the aperture value or the ISO sensitivity setting. Additionally, the control range changes in the following continuous shooting settings.

Setting		Control range (second)			
		P mode	S mode	A mode	M mode
ISO sensitivity (  62)	Auto <sup>1</sup>	1/2000 - 1 s	1/2000 <sup>2</sup> - 2 s		1/2000 - 8 s
	ISO 125-400 <sup>1</sup> , ISO 125-800 <sup>1</sup>		1/2000 <sup>2</sup> - 4 s		
	ISO 125, 200		1/2000 <sup>2</sup> - 8 s		
	ISO 400, 800		1/2000 <sup>2</sup> - 4 s		
	ISO 1600		1/2000 <sup>2</sup> - 2 s		
	ISO 3200, 6400		1/2000 <sup>2</sup> - 1 s		
Continuous (  62)	Continuous H, Continuous L, BSS	1/2000 <sup>2</sup> - 1 s			
	Pre-shooting cache	1/4000 - 1/120 s	1/4000 - 1/125 s	1/4000 - 1/120 s	1/4000 - 1/125 s
	Continuous H: 120 fps				
	Continuous H: 60 fps	1/4000 - 1/60 s			
	Multi-shot 16	1/4000 - 1/30 s			

<sup>1</sup> In **M** mode, the ISO sensitivity is fixed at ISO 125.

<sup>2</sup> In **A** mode, the maximum shutter speed varies depending on the aperture value. When the aperture value is set to f/3.7 to 5.3 at the wide-angle position or f/6.4 to 8 at the telephoto zoom position, the maximum shutter speed is 1/1000 second.



## Functions That Can Be Set Using the Multi Selector

The functions that are available vary with the shooting mode, as shown below.

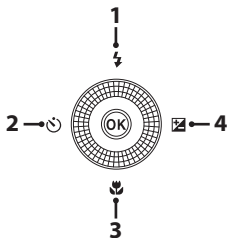

Function		SCENE		EFFECTS	P, S, A, M
<b>1</b> Flash mode (📖50)	✓		✓ <sup>1</sup>	✓	✓
<b>2</b> Self-timer (📖53)	✓		✓ <sup>1</sup>	✓	✓
<b>3</b> Macro mode (📖54)	✓		-	✓	✓
<b>4</b> Creative slider Brightness (Exp. +/-)/ Vividness/ Hue (📖55)	-	1	-	-	✓ <sup>2</sup>
Exposure compensation (📖58)	✓		✓	✓	-

<sup>1</sup> Availability depends on the setting. See “Default Settings” (📖59) for more information.

<sup>2</sup> Brightness (Exp. +/-) cannot be set in **M** mode.

## Using the Flash

You can select the flash mode to match the shooting conditions.

- 1 Press the multi selector ▲ (⚡).

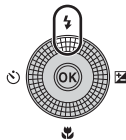

- 2 Select the desired flash mode (ⓘ52) and press the OK button.

- If a setting is not applied by pressing the OK button within a few seconds, the selection will be canceled.

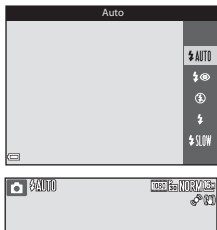

### ✓ The Flash Lamp

- The status of the flash can be confirmed by pressing the shutter-release button halfway.
  - On: The flash fires when you press the shutter-release button all the way down.
  - Flashing: The flash is charging. The camera cannot shoot images.
  - Off: The flash does not fire when an image is taken.
- If the battery level is low, the monitor turns off while the flash is charging.



## Raising the Flash

When you press the shutter-release button halfway, the flash will automatically pop up if the conditions required for flash photography are met.

- Auto flash (⚡AUTO auto, ⚡👁 auto with red-eye reduction, or ⚡SLOW slow sync): If the lighting is dim, the flash automatically pops up when the shutter-release button is pressed halfway. The camera determines whether or not the flash pops up based on the brightness of the subject and the settings used during shooting.
- 🚫 off: The flash does not pop up, even when the shutter-release button is pressed halfway. The camera can shoot images with the flash lowered.
- ⚡👁 red-eye reduction, ⚡ fill flash/standard flash: The flash pops up when the shutter-release button is pressed halfway during shooting.

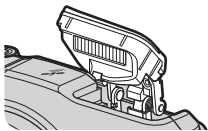

## Lowering the Flash

When not using the flash, gently push to lower the flash until it clicks shut.

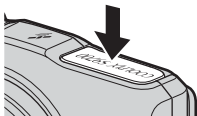

## Available Flash Modes

### AUTO Auto

The flash fires when necessary, such as in dim lighting.

- The flash mode icon on the shooting screen is displayed only immediately after the setting is made.
- Not available in shooting modes **P**, **S**, **A**, and **M**, and in some scene modes.

### Auto with red-eye reduction/Red-eye reduction

Reduce “red-eye” in portraits caused by the flash.

- Red-eye reduction is used in shooting modes **P**, **S**, **A**, and **M** to fire the flash whenever an image is taken.

### Off

The flash does not fire.

- We recommend using a tripod to stabilize the camera when shooting in dark surroundings.

### Fill flash/Standard flash

The flash fires whenever an image is taken.

- **Standard flash** is displayed in shooting modes **P**, **S**, **A**, and **M**.

### SLOW Slow sync

Suited to evening and night portraits that include background scenery.

The flash fires when necessary to illuminate the main subject; slow shutter speeds are used to capture background at night or under dim lighting.

- Not available in shooting modes **S** and **A**, and in some scene modes.

## The Flash Mode Setting

- The setting may not be available with some shooting modes.
- For shooting modes **P**, **S**, **A** and **M**, the setting is saved in the camera’s memory even after the camera is turned off.

## Auto with Red-eye Reduction/Red-eye Reduction

Pre-flashes are fired repeatedly at low intensity before the main flash, reducing the red-eye effect. If the camera detects red-eye while saving an image, the affected area is processed to reduce red-eye before the image is saved.

Note the following when shooting:

- Because pre-flashes are fired, there is a slight lag between when the shutter-release button is pressed and when the image is shot.
- More time than usual is required to save images.
- Red-eye reduction may not produce the desired results in all situations.
- In some rare cases, red-eye reduction may be applied unnecessarily to other areas of the image. In these cases, select another flash mode and take the image again.

## Using the Self-timer

The camera is equipped with a self-timer that releases the shutter about 10 seconds or 2 seconds after you press the shutter-release button. Set **Photo VR** to **Off** in the setup menu (📖83) when using a tripod to stabilize the camera during shooting.

- 1 Press the multi selector ◀ (🕒).

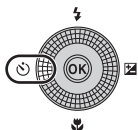

- 2 Select 🕒 10s or 🕒 2s, and press the OK button.

- 🕒 10s (10 seconds): Use on important occasions, such as weddings.
- 🕒 2s (2 seconds): Use to prevent camera shake.
- If a setting is not applied by pressing the OK button within a few seconds, the selection will be canceled.
- When the shooting mode is **Pet portrait** scene mode, 🐾 (pet portrait auto release) is displayed (📖38). The self-timer cannot be used.

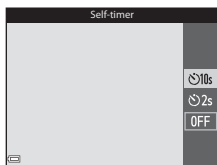

- 3 Frame the picture and press the shutter-release button halfway.

- Focus and exposure are set.

- 4 Press the shutter-release button the rest of the way down.

- Countdown starts. The self-timer lamp flashes and then glows steadily about one second before the shutter is released.
- When the shutter is released, the self-timer is set to **OFF**.
- To stop the countdown, press the shutter-release button again.

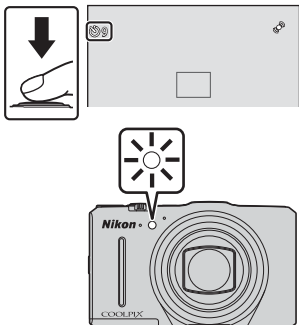

# Using Macro Mode

Use macro mode when taking close-up images.

- 1 Press the multi selector ▼ (🌿).

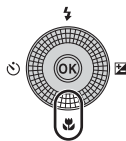

- 2 Select ON and press the OK button.

- If a setting is not applied by pressing the OK button within a few seconds, the selection will be canceled.

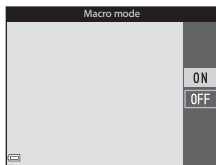

- 3 Move the zoom control to set the zoom ratio to a position where the zoom indicator glow green.

- When the zoom ratio is set to a position where the zoom indicator glows green, the camera can focus on subjects as close as approximately 10 cm (4 in.) from the lens.  
When the zoom is at the position where 🏠 is displayed, the camera can focus on subjects as close as approximately 1 cm (0.4 in.) from the lens.



## ✓ Notes About Using the Flash

The flash may be unable to light the entire subject at distances of less than 50 cm (1 ft 8 in.).

## 📎 The Macro Mode Setting

- The setting may not be available with some shooting modes.
- For shooting modes **P**, **S**, **A** and **M**, the setting is saved in the camera's memory even after the camera is turned off.

## Adjusting Brightness (Exposure Compensation), Vividness, and Hue (Creative Slider)

When the shooting mode is set to **P**, **S**, **A**, or **M** mode, use the creative slider to adjust brightness (exposure compensation), vividness, and hue for taking images.





### Operating the Creative Slider

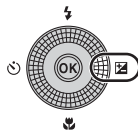

#### 1 Press the multi selector .

- In **M** mode, use  to select  (creative slider) and press the  button.



#### 2 Select the item you want to adjust and make an adjustment.

- : Select an item.
  - : "Adjusting Brightness (Exposure Compensation)" (📖56)
  - : "Adjusting Vividness (Saturation Adjustment)" (📖57)
  - : "Adjusting Hue (White Balance Adjustment)" (📖57)

-  or  or rotation: The slider moves. The effect can be adjusted while confirming the results on the monitor.
- To turn off the effects of the creative slider, select **R** and press the  button.

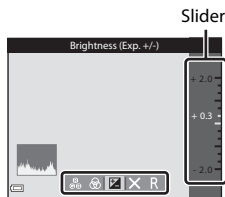

#### 3 When adjustment is complete, select and press the button.

- If the  button (except when **R** is selected) or the shutter-release button is pressed in step 2, the selected amount of effect is applied. When the effect is applied, the camera returns to the shooting screen.



#### Creative Slider Settings

The settings for Brightness (Exp. +/-), Vividness and Hue are saved in the camera's memory even after the camera is turned off.

## Adjusting Brightness (Exposure Compensation)

Adjust the overall brightness of the image.

- To brighten the image, set a positive (+) value.
- To darken the image, set a negative (-) value.

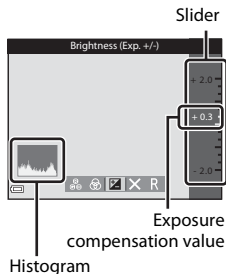

### ✓ Notes About Exposure Compensation

Brightness adjustment (exposure compensation) cannot be used in **M** mode.

### 📎 Using the Histogram

A histogram is a graph showing the distribution of tones in the image. Use as a guide when using exposure compensation and shooting without the flash.

- The horizontal axis corresponds to pixel brightness, with dark tones to the left and bright tones to the right. The vertical axis shows the number of pixels.
- Increasing exposure compensation shifts tone distribution to the right, and decreasing it shifts tone distribution to the left.



## Adjusting Vividness (Saturation Adjustment)

Adjust the overall vividness of the image.

- The overall image vividness increases as the slider is moved up. The overall image vividness decreases as the slider is moved down.

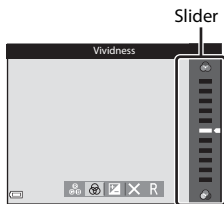

## Adjusting Hue (White Balance Adjustment)

Adjust the overall hue of the image.

- The overall image becomes more reddish as the slider is moved up. The overall image becomes more bluish as the slider is moved down.

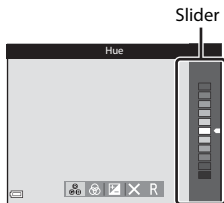

### Notes About White Balance Adjustment

The setting may not be changed when using certain settings of other functions.

## Adjusting Brightness (Exposure Compensation)

When the shooting mode is set to  (auto) mode, scene mode, smart portrait mode or special effects mode, you can adjust the brightness (exposure compensation).

- 1 Press the multi selector .

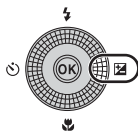

- 2 Select a compensation value and press the  button.

- To brighten the image, set a positive (+) value.
- To darken the image, set a negative (-) value.
- The compensation value is applied, even without pressing the  button.

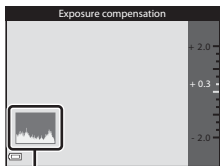





Histogram









### Exposure Compensation Value



































- When the shooting mode is **Fireworks show**  (36) in scene mode, the exposure compensation cannot be used.
- When the exposure compensation is set while using the flash, the compensation is applied to both the background exposure and to the flash output.

















## Default Settings

Default settings for each shooting mode are described below.

Shooting mode	Flash (  50)	Self-timer (  53)	Macro (  54)	Creative slider (  55)
<b>P, S, A, M</b>		OFF	OFF	Off

Shooting mode	Flash (  50)	Self-timer (  53)	Macro (  54)	Exposure compensation (  58)
 (auto)	 AUTO	OFF	OFF	0.0
 (smart portrait)	 AUTO <sup>1</sup>	OFF <sup>2</sup>	OFF <sup>3</sup>	0.0
<b>EFFECTS</b> (special effects)		OFF	OFF	0.0

Shooting mode	Flash (  50)	Self-timer (  53)	Macro (  54)	Exposure compensation (  58)
<b>SCENE</b>				
 (scene auto selector)	 AUTO <sup>4</sup>	OFF	OFF <sup>5</sup>	0.0
 (portrait)	 	OFF	OFF <sup>3</sup>	0.0
 (landscape)	 <sup>3</sup>	OFF	OFF <sup>3</sup>	0.0
 (sports)	 <sup>3</sup>	OFF <sup>3</sup>	OFF <sup>3</sup>	0.0
 (night portrait)	  <sup>3</sup>	OFF	OFF <sup>3</sup>	0.0
 (party/indoor)	  <sup>6</sup>	OFF	OFF <sup>3</sup>	0.0
 (beach)	 AUTO	OFF	OFF <sup>3</sup>	0.0
 (snow)	 AUTO	OFF	OFF <sup>3</sup>	0.0
 (sunset)	 <sup>3</sup>	OFF	OFF <sup>3</sup>	0.0
 (dusk/dawn)	 <sup>3</sup>	OFF	OFF <sup>3</sup>	0.0
 (night landscape)	 <sup>3</sup>	OFF	OFF <sup>3</sup>	0.0
 (close-up)	 <sup>3</sup>	OFF	ON <sup>3</sup>	0.0
 (food)	 <sup>3</sup>	OFF	ON <sup>3</sup>	0.0
 (museum)	 <sup>3</sup>	OFF	OFF	0.0

Shooting mode	Flash (  50)	Self-timer (  53)	Macro (  54)	Exposure compensation (  58)
 (fireworks show)	 <sup>3</sup>	OFF <sup>3</sup>	OFF <sup>3</sup>	0.0 <sup>3</sup>
 (black and white copy)		OFF	OFF	0.0
 (backlighting)	 <sup>7</sup> /  <sup>7</sup>	OFF	OFF <sup>3</sup>	0.0
 (easy panorama)	 <sup>3</sup>	OFF <sup>3</sup>	OFF <sup>3</sup>	0.0
 (pet portrait)	 <sup>3</sup>	 <sup>8</sup>	OFF	0.0

<sup>1</sup> Cannot be used when **Blink proof** is set to **On** or when **Smile timer** is set to **On (continuous)** or **On (BSS)**.



<sup>2</sup> Can be set when **Smile timer** is set to **Off**.

<sup>3</sup> The setting cannot be changed.

<sup>4</sup> The camera automatically selects the flash mode appropriate for the scene it has selected.  (off) can be selected manually.

<sup>5</sup> Cannot be changed. The camera enters macro mode when  is selected.

<sup>6</sup> May switch to slow sync with red-eye reduction flash mode.

<sup>7</sup> Flash is fixed at  (fill flash) when **HDR** is set to **Off**, and is fixed at  (off) when **HDR** is set to **On**.

<sup>8</sup> Self-timer cannot be used. Pet portrait auto release can be turned on or off (38).

## Functions That Can Be Set with the MENU Button (Shooting Menu)

The settings listed below can be changed by pressing the **MENU** button during shooting (📖4).

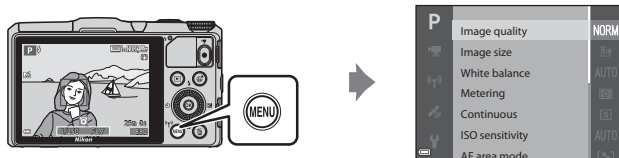















Available functions vary depending on the shooting mode, as shown below.





Function	📷	SCENE <sup>2</sup>	😊	EFFECTS	P, S, A, M
Image quality <sup>1</sup>	✓	✓	✓	✓	✓
Image size <sup>1</sup>	✓	✓	✓	✓	✓
White balance	-	-	-	-	✓
Metering	-	-	-	-	✓
Continuous	-	-	-	-	✓
ISO sensitivity	-	-	-	-	✓
AF area mode	-	-	-	-	✓
Autofocus mode	-	-	-	-	✓
Quick effects	-	-	-	-	✓
M exposure preview	-	-	-	-	✓
Skin softening	-	-	✓	-	-
Smile timer	-	-	✓	-	-
Blink proof	-	-	✓	-	-

<sup>1</sup> The setting is also applied to other shooting modes (except **Easy panorama** scene mode).

<sup>2</sup> Additional settings are available for some scene modes. See “Tips and Notes” (📖33) for more information.





## Options Available in the Shooting Menu

Option	Description	
Image quality	Allows you to set the image quality (compression ratio) used when saving images. • Default setting: <b>Normal</b>	 29
Image size	Allows you to set the image size used when saving images. • Default setting:  <b>4608×3456</b>	 30
White balance	Allows you to adjust white balance to suit the weather conditions or light source in order to make the colors in images match what you see with your eyes. • Default setting: <b>Auto</b>	 31
Metering	Allows you to set the method that the camera uses to measure the brightness of the subject. • Default setting: <b>Matrix</b>	 33
Continuous	Allows you to select single or continuous shooting. • Default setting: <b>Single</b>	 34
ISO sensitivity	Allows you to control the camera's sensitivity to light. • Default setting: <b>Auto</b> When <b>Auto</b> is selected, <b>ISO</b> is displayed in the monitor while shooting if ISO sensitivity increases.	 37
AF area mode	Allows you to determine how the camera selects the focus area that is used for autofocus. • Default setting: <b>Target finding AF</b> (  68)	 38
Autofocus mode	Allows you to set the method how the camera focuses. • Default setting: <b>Pre-focus</b>	 41
Quick effects	Allows you to enable or disable the quick effects function (  44). • Default setting: <b>On</b>	 41
M exposure preview	Allows you to select whether or not changes in the brightness are also reflected on the shooting screen when the exposure is changed in <b>M</b> (manual) mode. • Default setting: <b>On</b>	 42

Option	Description	
Skin softening	Allows you to select the skin softening level for human faces. <ul style="list-style-type: none"><li>• Default setting: <b>Normal</b></li></ul>	 43
Smile timer	Allows you to select whether or not the camera automatically releases the shutter when it detects a human smiling face. <ul style="list-style-type: none"><li>• Default setting: <b>On (single)</b></li></ul>	 44
Blink proof	The camera automatically releases the shutter twice with every shot and saves one image in which the subject's eyes are open. <ul style="list-style-type: none"><li>• Default setting: <b>Off</b></li></ul>	 45

## Functions That Cannot Be Used Simultaneously

Some functions cannot be used with other menu options.

Restricted function	Option	Description
Flash mode	Continuous (📖62)	When a setting other than <b>Single</b> is selected, the flash cannot be used.
	Blink proof (📖63)	When <b>Blink proof</b> is set to <b>On</b> , the flash cannot be used.
Self-timer	Smile timer (📖63)	When <b>Smile timer</b> is selected, the self-timer cannot be used.
	AF area mode (📖62)	When <b>Subject tracking</b> is selected, the self-timer cannot be used.
Macro mode	AF area mode (📖62)	When <b>Subject tracking</b> is selected, macro mode cannot be used.
Image quality	Continuous (📖62)	When <b>Pre-shooting cache</b> , <b>Continuous H: 120 fps</b> , <b>Continuous H: 60 fps</b> , or <b>Multi-shot 16</b> is selected, the setting is fixed at <b>Normal</b> .
Image size	Continuous (📖62)	<p><b>Image size</b> is fixed as follows depending on the continuous shooting setting:</p> <ul style="list-style-type: none"> <li>• <b>Pre-shooting cache:</b>   (image size: 1280 × 960 pixels)</li> <li>• <b>Continuous H: 120 fps:</b>   <b>640×480</b></li> <li>• <b>Continuous H: 60 fps:</b>   (image size: 1280 × 960 pixels)</li> <li>• <b>Multi-shot 16:</b>   (image size: 2560 × 1920 pixels)</li> </ul>



Restricted function	Option	Description
White balance	Hue (using the creative slider) (📖55)	When hue is adjusted using the creative slider, <b>White balance</b> in the shooting menu cannot be set. To set <b>White balance</b> , select <b>R</b> in the creative slider setting screen to reset the brightness, vividness, and hue.
Continuous	Self-timer (📖53)	If the self-timer is used when <b>Pre-shooting cache</b> is selected, <b>Continuous</b> operates using the <b>Single</b> setting.
ISO sensitivity	Continuous (📖62)	When <b>Pre-shooting cache</b> , <b>Continuous H: 120 fps</b> , <b>Continuous H: 60 fps</b> , or <b>Multi-shot 16</b> is selected, the <b>ISO sensitivity</b> setting is automatically specified according to the brightness.
AF area mode	White balance (📖62)	When a setting other than <b>Auto</b> is selected for <b>White balance</b> in <b>Target finding AF</b> mode, the camera does not detect the main subject.
Quick effects	Continuous (📖62)	The quick effects function cannot be used for images with continuous shooting.
Smile timer	Blink proof (📖63)	When <b>Blink proof</b> is set to <b>On</b> , <b>Smile timer</b> operates using the <b>On (single)</b> setting if <b>On (continuous)</b> or <b>On (BSS)</b> is set.
Blink proof	Smile timer (📖63)	When <b>Smile timer</b> is set to <b>On (continuous)</b> or <b>On (BSS)</b> , <b>Blink proof</b> operates using the <b>Off</b> setting.

Restricted function	Option	Description
Monitor settings	Quick effects (📖62)	When <b>Quick effects</b> is set to <b>On</b> , the captured image is displayed after each shot regardless of the <b>Image review</b> setting.
Print date	Continuous (📖62)	When <b>Continuous H</b> , <b>Continuous L</b> , <b>Pre-shooting cache</b> , <b>Continuous H: 120 fps</b> , <b>Continuous H: 60 fps</b> or <b>BSS</b> is selected, date and time cannot be imprinted on images.
	Smile timer (📖63)	When <b>Smile timer</b> is set to <b>On (continuous)</b> or <b>On (BSS)</b> , date and time cannot be imprinted on images.
	Blink proof (📖63)	When <b>Blink proof</b> is set to <b>On</b> , date and time cannot be imprinted on images.
Photo VR	Flash mode (📖50)	If the flash fires when <b>On (hybrid)</b> is selected, <b>Photo VR</b> operates using the <b>On</b> setting.
	Self-timer (📖53)	If the self-timer is used when <b>On (hybrid)</b> is selected, <b>Photo VR</b> operates using the <b>On</b> setting.
	Continuous (📖62)	If <b>Continuous</b> is set to any setting other than <b>Single</b> when <b>On (hybrid)</b> is selected, <b>Photo VR</b> operates using the <b>On</b> setting.
	ISO sensitivity (📖62)	If <b>ISO sensitivity</b> is set to <b>Fixed range auto</b> or ISO 400 or higher when <b>On (hybrid)</b> is selected, <b>Photo VR</b> operates using the <b>On</b> setting.
	Motion detection (📖83)	If <b>Motion detection</b> is set to <b>Auto</b> when <b>On (hybrid)</b> is selected, <b>Photo VR</b> operates using the <b>On</b> setting.

Restricted function	Option	Description
Motion detection	Flash mode (📖50)	When the flash fires, <b>Motion detection</b> is disabled.
	Continuous (📖62)	When <b>Pre-shooting cache</b> , <b>Continuous H: 120 fps</b> , <b>Continuous H: 60 fps</b> or <b>Multi-shot 16</b> is selected, <b>Motion detection</b> is disabled.
	ISO sensitivity (📖62)	When <b>ISO sensitivity</b> is set to any setting other than <b>Auto</b> , <b>Motion detection</b> is disabled.
Blink warning	Continuous (📖62)	When a setting other than <b>Single</b> is selected, <b>Blink warning</b> is disabled.
Digital zoom	Continuous (📖62)	When <b>Multi-shot 16</b> is selected, digital zoom cannot be used.
	AF area mode (📖62)	When <b>Subject tracking</b> is selected, digital zoom cannot be used.
Shutter sound	Continuous (📖62)	When a setting other than <b>Single</b> is selected, the shutter sound is disabled.

### ✔ Notes About Digital Zoom

- Depending on the shooting mode or the current settings, digital zoom may not be available (📖71).
- When digital zoom is in effect, the camera focuses in the center of the frame.

# Focusing

The focus area varies depending on the shooting mode.

## Using Target Finding AF

In auto mode or when **AF area mode** (📖62) in **P**, **S**, **A**, or **M** mode is set to **Target finding AF**, the camera focuses in the manner described below.

- When the camera detects the main subject, a yellow border (focus area) is displayed around it. If a human face is detected, the camera automatically sets focus priority on it. When you press the shutter-release button halfway, the focus area that is in focus glows green.

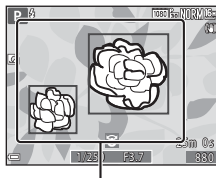

Focus areas

- If no main subject is detected, the camera automatically selects one or more of the 9 focus areas containing the subject closest to the camera when you press the shutter-release button halfway. When the subject is in focus, the focus areas that are in focus glow green.

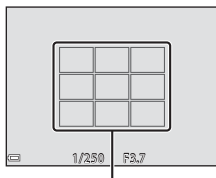

Focus areas

### ✓ Notes About Target Finding AF

- Depending on shooting conditions, the subject that the camera determines to be the main subject may vary.
- The main subject may not be detected when using certain **White balance** settings.
- The camera may not detect the main subject appropriately in the following situations:
  - When the subject is very dark or bright
  - When the main subject lacks clearly defined colors
  - When the shot is framed so that the main subject is at the edge of the monitor
  - When the main subject is composed of a repeating pattern

## Using Face Detection

In the following shooting modes, the camera uses face detection to automatically focus on human faces.

- **Scene auto selector**, **Portrait**, or **Night portrait** scene mode (📖32)
- Smart portrait mode (📖39)
- When **AF area mode** (📖62) in **P**, **S**, **A**, or **M** mode (📖43) is set to **Face priority**.

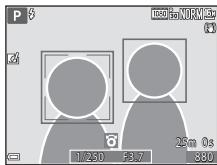

If the camera detects more than one face, a double border is displayed around the face that the camera focuses on, and single borders are displayed around the other faces.

If the shutter-release button is pressed halfway when no faces are detected:

- When **Scene auto selector** is selected, the focus area changes depending on the scene.
- In **Portrait** or **Night portrait** scene mode or smart portrait mode, the camera focuses on the area in the center of the frame.
- In **P**, **S**, **A**, or **M** mode, the camera selects the focus area containing the subject closest to the camera.

### ✓ Notes About Face Detection

- The camera's ability to detect faces depends on a variety of factors, including the direction in which the faces are looking.
- The camera may be unable to detect faces in the following situations:
  - When faces are partially hidden by sunglasses or otherwise obstructed
  - When faces take up too much or too little of the frame

### 📎 Face Detection During Movie Recording

When **AF area mode** (📖80) in the movie menu is set to **Face priority**, the camera focuses on human faces during movie recording.

If the **Movie-Record** button (📷) is pressed when no faces are detected, the camera focuses on the area in the center of the frame.

## Using Skin Softening

When the shutter is released while using one of the shooting modes listed below, the camera detects human faces and processes the image to soften facial skin tones (up to 3 faces).

- Smart portrait mode (📖39)
  - The skin softening level can be adjusted.
- **Scene auto selector, Portrait, or Night portrait** scene mode (📖32)

Editing functions such as **Skin softening** can be applied to saved images by using **Glamour retouch** (📖74) even after shooting.

### ✔ Notes About Skin Softening

- It may take more time than usual to save images after shooting.
- Under some shooting conditions, the desired skin softening results may not be achieved, and skin softening may be applied to areas of the image where there are no faces.

## Subjects Not Suitable for Autofocus

The camera may not focus as expected in the following situations. In some rare cases, the subject may not be in focus despite the fact that the focus area or the focus indicator glows green:

- Subject is very dark
- Objects of sharply differing brightness are included in the scene (e.g. the sun behind the subject makes that subject appear very dark)
- No contrast between the subject and surroundings (e.g. a portrait subject wearing a white shirt is standing in front of a white wall)
- Several objects are at different distances from the camera (e.g. the subject is inside a cage)
- Subjects with repeating patterns (window blinds, buildings with multiple rows of similarly shaped windows, etc.)
- Subject is moving rapidly

In the situations noted above, try pressing the shutter-release button halfway to refocus several times, or focus on another subject positioned at the same distance from the camera as the actual desired subject, and use focus lock (📖71).

## Focus Lock

Focus lock shooting is recommended when the camera does not activate the focus area that contains the desired subject.

### 1 Set AF area mode to Center (📖61).

- **AF area mode** can be set when the shooting mode is set to **P**, **S**, **A**, or **M**.

### 2 Position the subject in the center of the frame and press the shutter-release button halfway.

- Confirm that the focus area glows green.
- Focus and exposure are locked.

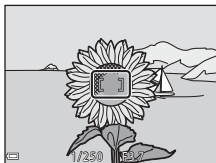

### 3 Without lifting your finger, recompose the picture.

- Make sure to maintain the same distance between the camera and the subject.

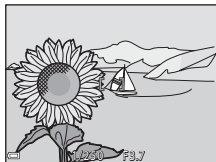

### 4 Press the shutter-release button the rest of the way down to take the picture.



# Playback Features

## Playback Zoom

Moving the zoom control toward **T** (Q) in full-frame playback mode (📖28) zooms in on the image.

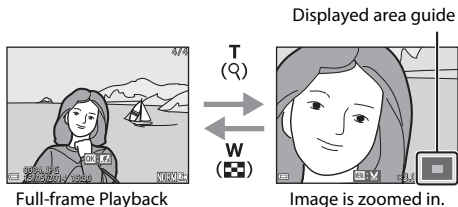

- You can change the zoom ratio by moving the zoom control toward **W** (checkered icon) or **T** (Q).
- To view a different area of the image, press the multi selector ▲▼◀▶.
- If you are viewing an image that was captured using face detection or pet detection, the camera zooms in on the face detected at the time of shooting (except when viewing an image captured in a series). To zoom in on an area of the image where there are no faces, adjust the zoom ratio and then press ▲▼◀▶.
- When a zoomed image is displayed, press the **OK** button to return to full-frame playback mode.

### Cropping Images

When a zoomed image is displayed, you can press the **MENU** button to crop the image to include only the visible portion and save it as a separate file (📖19).



## Thumbnail Playback, Calendar Display

Moving the zoom control toward **W** (📐) in full-frame playback mode (📖28) displays images as thumbnails.



- You can change the number of thumbnails displayed by moving the zoom control toward **W** (📐) or **T** (🔍).
- While using thumbnail playback mode, use the multi selector ▲▼◀▶ or rotate it to select an image, and then press the **OK** button to display that image full-frame.
- While using calendar display mode, use the multi selector ▲▼◀▶ or rotate it to select a date, and then press the **OK** button to display the images captured on that day.

### ☑ **Calendar Display**



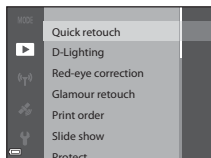
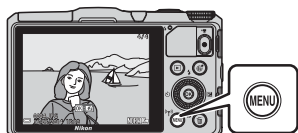

Images captured when the camera's date is not set are treated as images captured on January 1, 2014.

## Functions That Can Be Set with the MENU Button (Playback Menu)

When viewing images in full-frame playback mode or thumbnail playback mode, you can configure the menu operations listed below by pressing the **MENU** button (📖4).



Option	Description	📖
Quick retouch*	Allows you to create retouched copies in which contrast and saturation have been enhanced.	👓15
D-Lighting*	Allows you to create copies with enhanced brightness and contrast, brightening dark portions of an image.	👓15
Red-eye correction*	Corrects "red-eye" that may occur in images when shooting with a flash.	👓16
Glamour retouch*	Detects faces in images and retouches the detected faces glamorously.	👓17
Print order	Allows you to select which images are printed, and how many copies of each image are printed, prior to printing.	👓46
Slide show	Allows you to view images in an automatic slide show.	👓49
Protect	Protects selected images from accidental deletion.	👓50
Rotate image	Allows you to rotate the displayed image to portrait or landscape orientation.	👓51
Small picture*	Creates a small copy of images.	👓18
Voice memo	Allows you to use the camera's microphones to record voice memos and attach them to images.	👓52
Copy	Allows you to copy images between the internal memory and a memory card.	👓53

Option	Description	
Sequence display options	<p>Allows you to select whether to display only the key picture for a sequence of images captured continuously or to display the sequence as individual images.</p> <ul style="list-style-type: none"> <li>When only the key picture is displayed for a sequence, press the <b>OK</b> button to display each image in the sequence. Press the multi selector <b>▲</b> to return to the key picture display.</li> </ul>	 54
Choose key picture	Allows you to change the key picture for images captured in sequence.	 54
Favorite pictures	Allows you to add images to an album. This option is not displayed in favorite pictures mode.	 5
Remove from favorites	Allows you to remove images from an album. This option is displayed only in favorite pictures mode.	 7

\* Edited images are saved as separate files. Some images may not be edited.

# Recording and Playing Back Movies

## Recording Movies

### 1 Display the shooting screen.

- Check the remaining amount of movie recording time.
- If **Photo info** in the **Monitor settings** (☰83) in the setup menu is set to **Movie frame+auto info**, the area that will be visible in the movie can be confirmed before movie recording starts.



Movie recording time remaining

### 2 Press the **MOVIE** (movie-record) button to start movie recording.

- The focus area for autofocus differs depending on the setting of **AF area mode** (☰80).

The default setting is **Face priority**.

- Press the multi selector **▶** to pause recording, and press **▶** again to resume recording (except when **iFrame 720/30p** or **iFrame 720/25p**, or an HS movie option is selected in **Movie options**). Recording automatically ends if it remains paused for about five minutes.

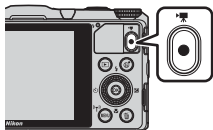

### 3 Press the **MOVIE** (movie-record) button again to end recording.

## ✓ Maximum Movie Length

Individual movie files cannot exceed 4 GB in size or 29 minutes in length, even when there is sufficient free space on the memory card for longer recording.

- The maximum movie length for a single movie is displayed on the shooting screen.
- Recording may end before either limit is reached if camera temperature becomes elevated.
- The actual movie length may vary depending on the movie content, subject movement, or type of memory card.

## ✓ Notes About Saving Images and Recording Movies

The indicator showing the number of exposures remaining or the indicator showing the maximum movie length flashes while images are being saved or while a movie is being recorded. **Do not open the battery-chamber/memory card slot cover or remove the battery or memory card** while an indicator is flashing. Doing this could result in loss of data, or in damage to the camera or the memory card.

## ✓ Notes About Movie Recording

- Memory cards with an SD Speed Class rating of 6 or faster are recommended when recording movies (⚙:29). Movie recording may stop unexpectedly when memory cards with a lower Speed Class rating are used.
- When using the camera's internal memory, saving movies may take some time.
- Depending on the file size of a movie, it may not be possible to save the movie in the internal memory or copy it from a memory card to the internal memory.
- There may be some degradation in image quality when digital zoom is used.
- The sounds of zoom control operation, zoom, autofocus lens drive movement, vibration reduction, and aperture operation when brightness changes may be recorded.
- The following phenomena may be seen in the monitor while recording movies. These phenomena are saved in the recorded movies.
  - Banding may occur in images under fluorescent, mercury-vapor, or sodium-vapor lighting.
  - Subjects that move quickly from one side of the frame to the other, such as a moving train or car, may appear skewed.
  - The entire movie image may be skewed when the camera is panned.
  - Lighting or other bright areas may leave residual images when the camera is moved.
- Depending on the distance to the subject or the amount of zoom applied, subjects with repeating patterns (fabrics, lattice windows, etc.) may have colored stripes (interference patterns, moire, etc.) in them during movie recording and playback. This occurs when the pattern in the subject and the layout of the image sensor interfere with each other; it is not a malfunction.

### ✓ Notes About Vibration Reduction During Movie Recording

- When **Movie VR** (📖80) in the movie menu is set to **On (hybrid)**, the angle of view (i.e., the area visible in the frame) becomes narrower during movie recording.
- When using a tripod to stabilize the camera during recording, set **Movie VR** to **Off** to prevent potential errors caused by this function.

### ✓ Camera Temperature

- The camera may become warm when shooting movies for an extended period of time or when the camera is used in a hot area.
- If the inside of the camera becomes extremely hot when recording movies, the camera will automatically stop recording.  
The amount of time remaining until the camera stops recording (🕒10s) is displayed.  
After the camera stops recording, it turns itself off.  
Leave the camera off until the inside of the camera has cooled.



### ✓ Notes About Autofocus

Autofocus may not perform as expected (📖70). Should this occur, try the following:

1. Set **AF area mode** to **Center** and **Autofocus mode** to **Single AF** (default setting) in the movie menu before starting movie recording.
2. Frame another subject—positioned at the same distance from the camera as the intended subject—in the center of the frame, press the ● (📹 movie-record) button to start recording, and then modify the composition.





## Saving Still Images While Recording Movies

If the shutter-release button is pressed all the way while recording a movie, one frame is saved as a still image. Movie recording continues while the still image is being saved.

-  is displayed at the top left of the monitor. When  is displayed, a still image cannot be saved.
- The image size of the still images to be saved is the same as the **Movie options** ()80 setting.



### Notes About Saving Still Images During Movie Recording









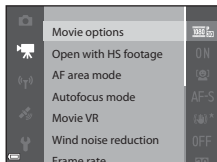

- Still images cannot be saved during movie recording in the following situations.
  - When movie recording is paused
  - When the remaining movie length is less than 5 seconds
  - When **Movie options** is set to  **1080/60i**,  **1080/50i**,  **480/30p**,  **480/25p** or HS movie
- Frames of a movie that were recorded when a still image was being taken may not be played back in a seamless manner.
- The sounds of operating the shutter-release button when saving a still image may be heard in the recorded movie.
- If the camera moves when the shutter-release button is pressed, the image may be blurred.

## Functions That Can Be Set with the MENU Button (Movie Menu)

Enter shooting mode → MENU button →  menu icon →  button



The settings of the menu options listed below can be configured.





Option	Description	
Movie options	Select the movie type. Select normal speed to record movies at normal speed, or HS (high speed) to record movies that play in slow or fast motion. • Default setting:  <b>1080/30p</b>  <b>1080/25p</b>	 55
Open with HS footage	Set whether to start recording HS movies or at normal speed when recording HS movies. • Default setting: <b>On</b>	 59
AF area mode	Set the method how the camera selects the focus area for autofocus during movie recording. • Default setting: <b>Face priority</b>	 59
Autofocus mode	Select either <b>Single AF</b> , which locks focus when movie recording begins, or <b>Full-time AF</b> , which continues focusing during movie recording. • Default setting: <b>Single AF</b>	 60
Movie VR	Select the vibration reduction setting used when recording movies. • Default setting: <b>On (hybrid)</b>	 61
Wind noise reduction	Set whether or not to reduce wind noise during movie recording. • Default setting: <b>Off</b>	 62
Frame rate	Select the frame rate used when recording movies.	 62



## Playing Back Movies

Press the  button to enter playback mode.  
Movies are indicated by the movie options icon  
(80).

Press the  button to play back movies.

- To adjust the volume, move the zoom control  
(1).

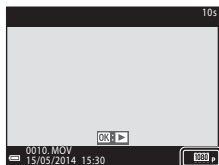

Movie options





Volume indicator













## Functions Available During Playback

Rotate the multi selector to fast forward or rewind.

Playback controls are displayed at the bottom of the monitor.

The operations listed below can be performed by using the multi selector  to select a control and then pressing the  button.



Function	Icon	Description
Rewind		Hold down the  button to rewind the movie.
Advance		Hold down the  button to advance the movie.
Pause		Pause playback. The operations listed below can be performed while paused.
		 Rewind the movie one frame. Hold down the  button for continuous rewinding.*
		 Advance the movie one frame. Hold down the  button for continuous advancing.*
		 Resume playback.
		 Extract the desired portion of a movie and save it as a separate file.
 Extract a single frame of a movie and save it as a still image.		
End		Return to full-frame playback mode.

\* The movie can also be advanced or rewound by rotating the multi selector.

## Deleting Movies

To delete a movie, select the desired movie in full-frame playback mode ()28) or thumbnail playback mode ()73) and press the  button ()29).









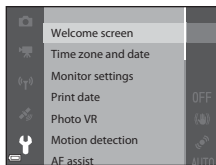

# General Camera Setup









## Functions That Can Be Set with the MENU Button (Setup Menu)

Press the MENU button → Y (setup) menu icon → OK button

The settings of the menu options listed below can be configured.



Option	Description	
Welcome screen	Allows you to select whether or not the welcome screen is displayed in the monitor when the camera is turned on.	 63
Time zone and date	Allows you to set the camera clock.	 64
Monitor settings	Allows you to adjust photo information display, post-shooting image review, and monitor brightness settings.	 66
Print date	Allows you to imprint the shooting date and time on images.	 68
Photo VR	Allows you to select the vibration reduction setting used when shooting still images.	 69
Motion detection	Allows you to set whether or not the camera automatically increases the shutter speed to reduce blurring caused by camera shake if motion is detected when shooting still images.	 70
AF assist	Allows you to enable or disable the AF-assist illuminator.	 70
Digital zoom	Allows you to enable and disable digital zoom.	 71
Sound settings	Allows you to adjust sound settings.	 72
Auto off	Allows you to set the amount of time that passes before the monitor turns off to save power.	 72

Option	Description	
<b>Format memory/ Format card</b>	Allows you to format the internal memory or the memory card.	 73
<b>Language</b>	Allows you to change the camera's display language.	 74
<b>TV settings</b>	Allows you to adjust TV-connection settings.	 74
<b>Charge by computer</b>	Allows you to set whether or not the battery in the camera is charged when the camera is connected to a computer.	 75
<b>Blink warning</b>	Allows you to set whether or not closed eyes are detected when taking images of people using face detection.	 76
<b>Eye-Fi upload</b>	Allows you to set whether or not to enable the function for sending images to a computer using a commercially available Eye-Fi card.	 77
<b>Reset all</b>	Allows you to reset the camera's settings to their default values.	 78
<b>Firmware version</b>	View the current camera firmware version.	 78

# Using Location Data Functions/ Displaying Maps

## Starting Location Data Recording

This camera receives signals from positioning satellites and obtains its current time and location data.

The obtained location data (latitude and longitude) can be recorded on the images to be shot.

### Turn the Location Data Functions On

Press the **MENU** button → 📍 (location data options) menu icon → Location data options → **OK** button

Set **Time zone and date** (📖83) correctly before using the location data functions.

- 1 Use the multi selector ▲▼ to select **Record location data**, and then press the **OK** button.

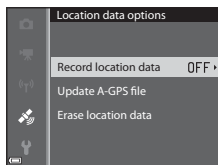

- 2 Select **On** and press the **OK** button.

- Signals are received from the positioning satellites and positioning starts.

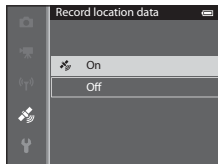

- 3 Press the **MENU** button.

- The camera returns to shooting screen.
- Operate in an open-air area when starting to receive signals from positioning satellites.





## ✓ Notes About Location Data Functions

- Before using the location data functions, read “<Important> Notes About Location Data Functions (GPS/GLONASS, Electronic Compass)” (📖xii).
- It takes a few minutes to obtain location data when positioning is performed for the first time or in a situation where positioning cannot be performed for a long period of time, or just after the battery is replaced.
- Positions of the positioning satellites change constantly.  
You may not be able to determine the position or it may take some time depending on your location and the time.  
To use the location data functions, use the camera in an open-air area with few obstacles in the sky.  
Signal receiving will be smoother if the positioning antenna (📖1) is facing the sky.
- The following locations which block or reflect signals may result in failed or inaccurate positioning.
  - Inside buildings or underground locations
  - Between high-rise buildings
  - Under overpasses
  - Inside tunnels
  - Near high-voltage electrical power lines
  - Between clusters of trees
- Using a mobile phone of 1.5 GHz band near this camera may disrupt positioning.
- When carrying this camera around while positioning, do not place it in a metal bag. Positioning cannot be performed if the camera is covered with metal materials.
- When there is a significant difference in the signals from the positioning satellites, there could be a deviation of up to several hundred meters.
- Be aware of your surroundings when positioning.
- The shooting date and time that is displayed when playing back images is determined by the camera's internal clock at the time of shooting.  
The time obtained by the location data and recorded on images will not be displayed on the camera.
- The location data for the first frame will be recorded on a series of images shot using continuous shooting.

## ✓ Battery Drain While Recording Location Data and Log Recording

- When **Record location data** is set to **On**, record location data functions will continue to operate at the specified interval for approximately 6 hours even after the camera is turned off. Also, record location data functions and log recording function will continue to operate during log recording (📖91) even after the camera is turned off.
- When **Record location data** is set to **On** or during log recording, the battery power will drain faster than usual.

## Location Data Reception Indicator and Points of Interest (POI) Information

- Location data reception can be checked on the shooting screen.
  - : Signals are being received from four or more satellites and positioning is being performed. The location data is recorded on the image.
  - : Signals are being received from three satellites and positioning is being performed. The location data is recorded on the image.
  - : Signals are being received from the satellites, but positioning is not possible. The location data is not recorded on the image.
  - : Signals cannot be received from the satellites, and positioning is not possible. The location data is not recorded on the image.
- POI information is location name information for landmarks (facilities) and other details.
  - When **Display POI** in **Points of interest (POI)** of the Location data options menu (📖91) is set to **On**, the nearest location name information for the current position is displayed during shooting.
  - When **Embed POI** is set to **On**, location name information can be recorded on the image during shooting.
  - If the location name information was recorded on the image during shooting, this information is displayed when **Display POI** is set to **On** during playback.
- The location name information may not be displayed depending on the setting level in **Level of detail** of **Points of interest (POI)**. Also, certain landmark names may not be registered, or the landmark name may be different.

### Location name information (POI information)



Location data reception

## Images with Recorded Location Data

- The  icon is displayed during playback for images which have the location data recorded (📖8).
- The location data recorded on an image can be checked on a map with ViewNX 2 after transferring the image to a computer (📖98).
- The actual place of shooting may differ from the location data recorded on the image files due to the accuracy of the location data obtained and a difference in the geodetic system used.
- The location data and POI information recorded on images can be erased using **Erase location data** in **Location data options** (📖91). The erased information cannot be recovered.

## Displaying Maps

The current position or image shooting location can be displayed on the screen using the camera's internal map information.



To display the map, press the  (map) button in shooting mode or playback mode.



- Maps cannot be displayed while the camera is being charged with the charging AC adapter.

## When Using Shooting Mode

To display the current position on the screen, press the  (map) button in shooting mode when **Record location data** in **Location data options** of the Location data options menu is set to **On**.

- To display the current position, the location data must have been obtained.
- To adjust the scale of the map, use the zoom control (**W** ) / (**T** ).

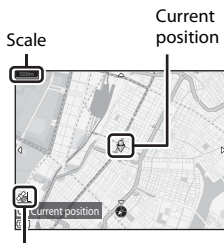

Location data reception

- To move the map display, use the multi selector.
- The following operations can be performed when you press the **OK** button.
  - **Center on current location:** Display the current position at the center of the map.
  - **Save location:** Select a location on the map and save it by pressing the **OK** button.
  - **Center on saved location:** Move the map by selecting a location you have saved (90). You can cancel a location you have saved.
- When the camera lens faces downward, a compass is displayed. A compass is displayed even if **Compass display** in the Location data options menu is set to **Off**.





## ✓ Map Display

- The map display cannot be rotated. Only the north up display (the top of the screen indicates the north) is available.
- The map display scale varies depending on which country is shown on the map.
- In shooting mode, when **Record location data** in **Location data options** of the Location data options menu is set to **Off** or when positioning could not be performed, a world map centered on the region that was set in **Time zone** of **Time zone and date** in the setup menu (📖83) or the last displayed map is displayed.

## When Using Playback Mode

If an image displaying 📷 in the full-frame display is selected and the 🗺️ (map) button is pressed, the image shooting location is displayed on the screen.

- To display the map and the image shooting location, the location data must have been recorded on playback image.
- To adjust the scale of the map, use the zoom control (W 🗺️/T 📏).
- To move the map display, use the multi selector.

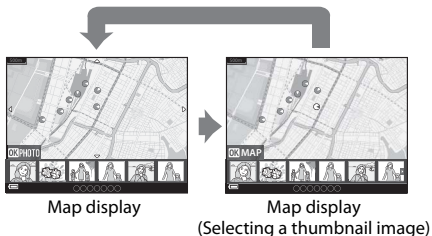
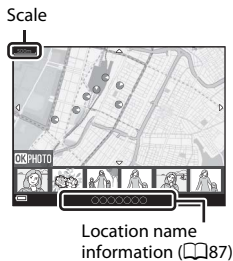

- When the Ⓞ button is pressed, another image can be selected. Only images with the recorded location data are displayed in the thumbnail display.

- The following operations can be performed when you press the **OK** button while thumbnails are displayed.
  - **Scroll map:** Return to the map display screen.
  - **Save location:** Save the shooting location of the image displayed as a location.
  - **Center on saved location:** Move the map by selecting a location you have saved (📖90). You can cancel a location you have saved.
- The image shooting location and a rough direction are indicated by 📍 on the map (📍 indicates north), and the selected image is highlighted in yellow.
- Press the multi selector **◀▶** to select the image.
- Move the zoom control toward **T** (🔍) to enlarge the image. Move the zoom control toward **W** (🗺️) to return to the map display.

Image shooting location and direction

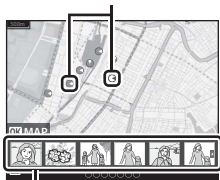

Thumbnail display



### Notes About Saving Locations

Up to 30 locations can be saved.

- When you select **Center on saved location**, the map scrolls to the closest saved location from the center of the screen.
- Use the multi selector **▲▼◀▶** to move to other saved locations.
- Press the **🗑️** button to cancel a location.
- When you press the **OK** button, the monitor display returns to the previous screen.









## Functions That Can Be Set Using the MENU Button (Location Data Options Menu)

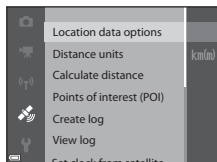



Press the MENU button →  (location data options) menu icon →  button

The settings of the menu options listed below can be configured.

- The Location data options menu can be displayed also by pressing the MENU button while the map is displayed.



Option	Description	
Location data options	Allows you to enable location data functions. To update the A-GPS file, access the website below: <a href="http://nikonimglib.com/agps3/">http://nikonimglib.com/agps3/</a> <ul style="list-style-type: none"> <li>Default setting:           <ul style="list-style-type: none"> <li><b>Record location data: Off</b></li> </ul> </li> </ul>	 79
Distance units	Allows you to set the distance units of the map display. <ul style="list-style-type: none"> <li>Default setting: <b>km (m)</b></li> </ul>	 80
Calculate distance	Allows you to calculate the linear distance from the current position to the shooting location of the image or between image shooting locations.	 81
Points of interest (POI)	Allows you to make the settings for the POI (points of interest, location name information). <ul style="list-style-type: none"> <li>Default setting:           <ul style="list-style-type: none"> <li><b>Embed POI: Off</b></li> <li><b>Display POI: Off</b></li> <li><b>Level of detail: Level 6 (detailed)</b></li> </ul> </li> </ul>	 82
Create log	Allows you to make settings for log recording of obtained location data. You can delete the log data or save it to memory card. <ul style="list-style-type: none"> <li>Default setting:           <ul style="list-style-type: none"> <li><b>Log interval: 15 s</b></li> <li><b>Start log: Log data for next 24 hrs</b></li> </ul> </li> </ul>	 83

Option	Description	
View log	Allows you to check or erase the log data saved on a memory card.	 85
Set clock from satellite	Allows you to set the date and time of the camera's internal clock using signals from the positioning satellites.	 86
Electronic compass	Allows you to set whether or not to display the electronic compass. You can display the electronic compass and calibrate it if it is not displaying the correct directions. <ul style="list-style-type: none"><li>• Default setting:<ul style="list-style-type: none"><li>- <b>Compass display: Off</b></li></ul></li></ul>	 87

# Using the Wi-Fi (Wireless LAN) Function

## Functions That Can Be Performed Using Wi-Fi

You can perform the following functions if you install the dedicated software “Wireless Mobile Utility” on your smart device that runs on Android OS or iOS, and connect it to the camera.

### Take Photos

You can take still images using the two methods described below.

- Release the shutter on the camera and save the captured images to a smart device.
- Use a smart device to remotely\* release the camera shutter and save images to the smart device.
  - \* Operations cannot be performed on the camera during remote control operation.

### View Photos

You can copy the images saved in the camera’s memory card and view them on your smart device.

## Installing the Software on the Smart Device

- 1** Use your smart device to connect to Google Play Store, App Store or other online apps marketplace and search for “Wireless Mobile Utility.”
  - Check the user’s manual provided with your smart device for further details.
- 2** Check the description and other information and install the software.
  - For more information about how to operate the software, download the user’s manual from the website below.
    - Android OS: <http://nikonimglib.com/ManDL/WMAU/>
    - iOS: <http://nikonimglib.com/ManDL/WMAU-ios/>

# Connecting the Smart Device to the Camera

Press the MENU button →  menu icon →  button

## 1 Use the multi selector ▲▼ to select **Connect to smart device** and press the button.

- If **Connect to smart device** cannot be selected, see “Notes About Wi-Fi Connection” (95).
- When the Wi-Fi function is turned on, the SSID and password of the camera are displayed.
- If no connection confirmation is received from the smart device within 3 minutes, the message “No access.” is displayed and the camera returns to the Wi-Fi options screen.

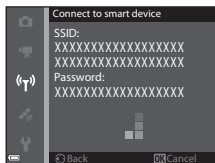
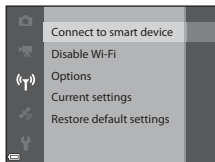

## 2 Set the Wi-Fi setting on the smart device to On.

- Check the user's manual provided with your smart device for further details.
- After the network name (SSID) that can be used for the smart device is displayed, select the SSID displayed on the camera.
- When the message for entering a password is displayed, enter the password that is displayed on the camera.
- When the camera is successfully connected to a Wi-Fi network, the shooting screen is displayed on the camera with the Wi-Fi communication indicator (7).

## 3 Start the “Wireless Mobile Utility” installed on the smart device.



- The screen for selecting “Take photos” or “View photos” is displayed.
- When the message “Cannot connect to camera.” is displayed, return to step 1 and retry the procedure.

## To Terminate the Wi-Fi Connection

Perform one of the following operations.

- Turn off the camera.
- Select **Disable Wi-Fi** in the Wi-Fi options menu on the camera (except when the camera is operated by remote control).
- Set the Wi-Fi setting on the smart device to Off.

### Notes About Wi-Fi Connection

- **Connect to smart device** cannot be selected in the following situations:
  - When no memory card is inserted in the camera.
  - When an Eye-Fi card (📷77) is inserted in the camera.
  - When the camera is connected to a TV, computer, or printer.
  - When the battery level indicator in the monitor indicates . In addition, if  is indicated when Wi-Fi is connected, the connection is terminated.
- Select **Disable Wi-Fi** in a place where the use of radio waves is prohibited.
- When Wi-Fi is connected, **Auto off** is disabled.
- When Wi-Fi is connected, the battery drains faster than normal.

### Notes About Security Settings

If the camera is installed with the Wi-Fi function without proper security settings (encryption and password), unauthorized third parties may access the network and cause harm. We strongly recommend performing the required security settings before using the Wi-Fi function.

Use **Options** of the Wi-Fi options menu (📷89) to perform the security settings.

# Connecting the Camera to a TV, Computer, or Printer

## Connection Methods

You can enhance your enjoyment of images and movies by connecting the camera to a TV, computer, or printer.

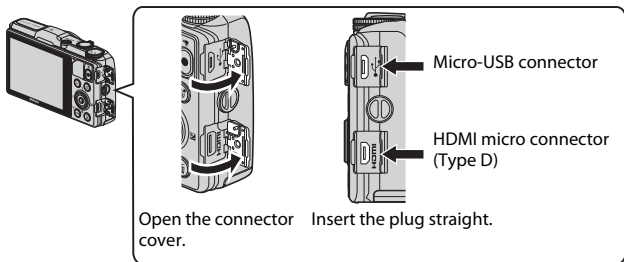

- Before connecting the camera to an external device, make sure the remaining battery level is sufficient and turn the camera off. Before disconnecting, make sure to turn the camera off.
- If the AC Adapter EH-62F (available separately) is used, this camera can be powered from an electrical outlet. Do not use any other make or model of AC adapter as it may cause the camera to heat up or malfunction.
- For information about the connection methods and subsequent operations, refer to the documentation included with the device in addition to this document.



## Viewing images on a TV

 20



Images and movies captured with the camera can be viewed on a TV.

Connection method: Connect a commercially available HDMI cable to the TV's HDMI input jack.

## Viewing and organizing images on a computer

 99



You can transfer images to a computer to perform simple retouching and manage image data.

Connection method: Connect the camera to the computer's USB port with the USB cable.

- Before connecting to a computer, install ViewNX 2 on the computer ( 98).
- If any USB devices that draw the power from the computer are connected, disconnect them from the computer before you connect the camera to it. Connecting the camera and other USB-powered devices to the same computer simultaneously may cause a camera malfunction or excessive power supply from the computer, which could damage the camera or memory card.

## Printing images without using a computer

 22



If you connect the camera to a PictBridge-compatible printer, you can print images without using a computer.

Connection method: Connect the camera directly to the printer's USB port with the USB cable.

## Using ViewNX 2

Install ViewNX 2 to upload, view, edit, and share photos and movies.



### Installing ViewNX 2

An Internet connection is required. For system requirements and other information, see the Nikon website for your region.

---

#### 1 Download the ViewNX 2 installer.

Start the computer and download the installer from:

*<http://nikonimglib.com/nvnx/>*

---

#### 2 Double-click the downloaded file.

---

#### 3 Follow the on-screen instructions.

---

#### 4 Exit the installer.

Click **Yes** (Windows) or **OK** (Mac).

# Transferring Images to the Computer

## 1 Choose how images will be copied to the computer.

Choose one of the following methods:

- **Direct USB connection:** Turn the camera off and ensure that the memory card is inserted in the camera. Connect the camera to the computer using the USB cable. The camera automatically turns on.

To transfer images that are saved in the camera's internal memory, remove the memory card from the camera before connecting it to the computer.

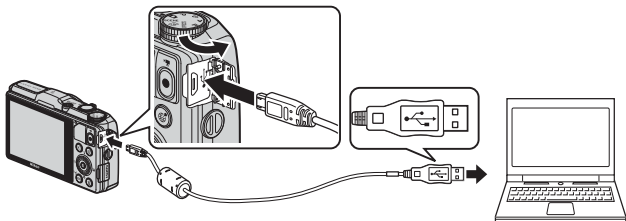

- **SD card slot:** If your computer is equipped with an SD card slot, the card can be inserted directly in the slot.
- **SD card reader:** Connect a card reader (available separately from third-party suppliers) to the computer and insert the memory card.

If a message is displayed prompting you to choose a program, select Nikon Transfer 2.

### • When using Windows 7

If the dialog shown at right is displayed, follow the steps below to select Nikon Transfer 2.

- 1 Under **Import pictures and videos**, click **Change program**. A program selection dialog will be displayed; select **Import File using Nikon Transfer 2** and click **OK**.
- 2 Double-click **Import File**.



If the memory card contains a large number of images, it may take a while for Nikon Transfer 2 to start. Wait until Nikon Transfer 2 starts.

## ✓ Connecting the USB Cable

The connection may not be recognized if the camera is connected to the computer via a USB hub.

---

## 2 Transfer images to the computer.

- Click **Start Transfer**.

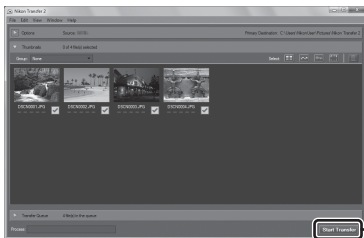

- At default settings, all the images on the memory card will be copied to the computer.

---

## 3 Terminate the connection.

- If the camera is connected to the computer, turn the camera off and disconnect the USB cable.
- If you are using a card reader or card slot, choose the appropriate option in the computer operating system to eject the removable disk corresponding to the memory card and then remove the card from the card reader or card slot.

# Viewing Images

## Start ViewNX 2.

- Images are displayed in ViewNX 2 when transfer is complete.
- Consult online help for more information on using ViewNX 2.

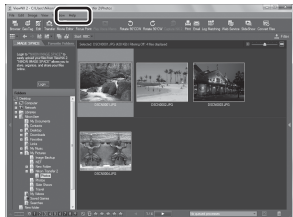

### Starting ViewNX 2 Manually

- **Windows:** Double-click the **ViewNX 2** shortcut on the desktop.
- **Mac:** Click the **ViewNX 2** icon in the Dock.



A series of horizontal dashed lines spanning the width of the page, intended for handwriting practice.



# Reference Section

The Reference Section provides detailed information and hints about using the camera.

## Shooting

---

Using Easy Panorama (Shooting and Playback) ..... 2

## Playback

---

Favorite Pictures Mode ..... 5  
Auto Sort Mode ..... 9  
List by Date Mode ..... 10  
Viewing and Deleting Images Captured Continuously  
(Sequence) ..... 11  
Editing Still Images ..... 13  
Connecting the Camera to a TV (Viewing Images on a TV) ... 20  
Connecting the Camera to a Printer (Direct Print) ..... 21  
Editing Movies ..... 27

## Menu

---

The Common Shooting Options (Image Quality and Image  
Size) ..... 29  
The Shooting Menu (**P**, **S**, **A**, or **M** Mode) ..... 31  
The Smart Portrait Menu ..... 43  
The Playback Menu ..... 46  
The Movie Menu ..... 55  
The Setup Menu ..... 63  
The Location Data Options Menu ..... 79  
The Wi-Fi Options Menu ..... 89

## Additional Information

---

Error Messages ..... 91  
File Names ..... 96  
Optional Accessories ..... 97

# Using Easy Panorama (Shooting and Playback)

## Shooting with Easy Panorama

Rotate the mode dial to **SCENE** → **MENU** button → Easy panorama → **OK** button

- 1 Select **Normal (180°)** or **Wide (360°)** as the shooting range and press the **OK** button.

- When the camera is readied in the horizontal position, the image size (width × height) is as follows.
  - **Normal (180°)**:  
4800 × 920 when moved horizontally,  
1536 × 4800 when moved vertically
  - **Wide (360°)**:  
9600 × 920 when moved horizontally,  
1536 × 9600 when moved vertically

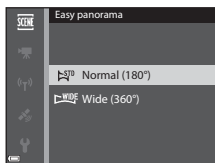

- 2 Frame the first edge of the panorama scene, and then press the shutter-release button halfway to focus.

- The zoom position is fixed at wide-angle position.
- The camera focuses on the area in the center of the frame.

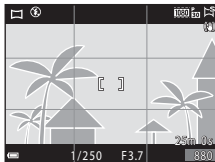

- 3 Press the shutter-release button all the way, and then remove your finger from the shutter-release button.

- $\triangle \nabla \langle \rangle$  are displayed to indicate the direction of camera movement.





#### 4 Move the camera in one of the four directions until the guide indicator reaches the end.

- When the camera detects which direction it is moving in, shooting begins.

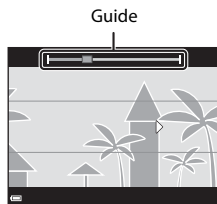

#### Example of Camera Movement

- Using your body as the axis of rotation, move the camera slowly in an arc, in the direction of the marking ( $\triangle \nabla \triangleleft \triangleright$ ).
- Shooting stops if the guide does not reach the edge within about 15 seconds (when **Normal (180°)** is selected) or within about 30 seconds (when **Wide (360°)** is selected) after shooting starts.



#### ✓ Notes About Easy Panorama Shooting

- The range of the image seen in the saved image is narrower than that seen in the monitor at the time of shooting.
- If the camera is moved too quickly or shaken too much, or if the subject is too uniform (e.g. walls or darkness), an error may occur.
- If shooting is stopped before the camera reaches the half-way point in the panorama range, a panorama image is not saved.
- If more than half of the panorama range is captured but shooting ends before reaching the edge of the range, the range not captured is recorded and displayed in gray.

## Viewing Images Captured with Easy Panorama

Switch to playback mode (📖28), display an image captured using easy panorama in full-frame playback mode, and then press the **OK** button to scroll the image in the direction that was used when shooting.

- Rotate the multi selector to scroll forward or backward quickly.

Playback controls are displayed at the bottom of the monitor during playback.

Use the multi selector **◀▶** to select a control, and then press the **OK** button to perform the following operations.

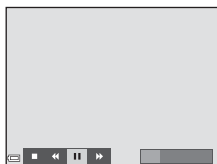

Function	Icon	Description
Rewind	◀◀	Hold down the <b>OK</b> button to scroll backward quickly.*
Advance	▶▶	Hold down the <b>OK</b> button to scroll forward quickly.*
Pause	⏸	Pause playback. The operations listed below can be performed while paused.
		◀◀   Hold down the <b>OK</b> button to rewind.*
		▶▶   Hold down the <b>OK</b> button to scroll.*
	▶	Resume automatic scrolling.
End	■	Switch to full-frame playback mode.

\* These operations can also be performed by rotating the multi selector.

### ✓ Notes About Scroll Playback

This camera may not be able to scroll the playback of, or zoom in on, easy panorama images captured with another make or model of digital camera.

## Favorite Pictures Mode

By adding images (except movies) to albums as favorite pictures, you can play back only the added images.

- Images can be sorted into nine albums. Up to 200 images can be added to each album.
- The original images are not copied or moved.
- The same image can be added to multiple albums.

## Adding Images to Albums

Press the button (playback mode\*) → MENU button → , or menu icon → Favorite pictures → button

\* Images cannot be added in favorite pictures playback mode.

**1** Use the multi selector to select an image and use to display .

- You can add to multiple images. To remove , press .
- Move the zoom control ( 1) toward **T** () to switch to full-frame playback or **W** () to switch to thumbnail playback.





**2** Press the button after configuring the settings.

**3** Select the desired album and press the button.

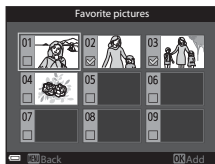

- The selected images are added.



## Playing Back Images in Albums

Press the  button (playback mode) → MENU button → MODE menu icon →  Favorite pictures →  button

Use the multi selector to select an album and then press the  button to play back the images in the selected album.

- Functions in the playback menu (74) can be used for the images in the selected album (except **Copy** and **Favorite pictures**).
- The following operations are available from the album selection screen.
  - MENU button: Changes the album icon (8).
  -  button: Deletes all original images added to the selected album.

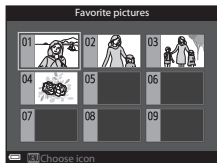

### Notes About Deletion

If an image is deleted while using favorite pictures mode, the original image is deleted. When removing images from albums, see "Removing Images from Albums" (67).

## Removing Images from Albums

Enter favorite pictures mode → select the album containing the image you want to remove → **OK** button → **MENU** button → Remove from favorites → **OK** button

**1** Use the multi selector **◀▶** to select an image and use **▲** to hide **★**.

- To display the icons again, press **▼**.
- Move the zoom control (**1**) toward **T** (**Q**) to switch to full-frame playback or **W** (**Q**) to switch to thumbnail playback.





**2** Press the **OK** button after configuring the settings.

**3** Select **Yes** and press the **OK** button.



- To cancel removal, select **No**.

## Changing the Favorites Album Icon

Press the  button (playback mode) → MENU button → MODE menu icon →  Favorite pictures →  button

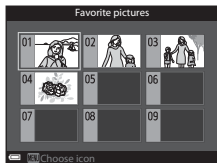
- 1 Use the multi selector to select an album and press the MENU button.



- 2 Use   to select an icon color and press the  button.

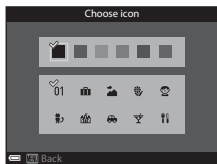

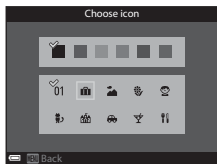

- 3 Select an icon and press the  button.

- The icon changes.





## Auto Sort Mode

Images are automatically sorted into categories, such as portraits, landscapes, and movies, based on the camera settings at the time of shooting.

Press the  button (playback mode) → MENU button → MODE menu icon →  Auto sort →  button

Use the multi selector to select a category and then press the  button to play back the images in the selected category.

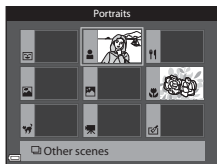

- Functions in the playback menu ( 74) can be used for the images in the selected category (except **Copy** and **Remove from favorites**).
- While the category selection screen is displayed, press the  button to delete all original images in the selected category.





### Notes About Auto Sort Mode





- Up to 999 images and movie files can be sorted into each category in auto sort mode.
- Images or movies saved by cameras other than this camera cannot be played back in auto sort mode.

## List by Date Mode

Press the  button (playback mode) → MENU button → MODE menu icon →  List by date →  button

Use the multi selector to select a date and then press the  button to play back the images captured on the selected date.

- Functions in the playback menu ( 74) can be used for the images in the selected shooting date (except **Copy** and **Remove from favorites**).
- The following operations are available while the shooting date selection screen is displayed.
  - **MENU** button: The functions listed below are available.
    - Print order\*
    - Slide show
    - Protect\*
  - \* The same settings can be applied to all images captured on the selected date.
  -  button: Deletes all images captured on the selected date.

List by date		
	20/05/2014	[ 3 ]
	15/05/2014	[ 2 ]
	10/05/2014	[ 1 ]
	05/05/2014	[ 10 ]

### Notes About List by Date Mode

- Up to the most recent 29 dates can be selected. If images exist for more than 29 dates, all images saved earlier than the most recent 29 dates will be combined under **Others**.
- The 9,000 most recent images can be displayed.
- Images captured when the camera's date is not set are treated as images captured on January 1, 2014.



# Viewing and Deleting Images Captured Continuously (Sequence)

## Viewing Images in a Sequence

Images captured continuously are saved as a sequence.

The first image of a sequence is used as the key picture to represent the sequence when displayed in full-frame playback mode or thumbnail playback mode (default setting).

To display each image in the sequence individually, press the **OK** button.



After pressing the **OK** button, the operations listed below are available.

- To display the previous or next image, rotate the multi selector or press **◀▶**.
- To display images that are not included in the sequence, press **▲** to return to the key picture display.
- To display images in a sequence as thumbnails, or to play them back in a slide show, set **Sequence display options** to **Individual pictures** in the playback menu (**54**).



### **✓** Sequence Display Options

Images captured continuously with cameras other than this camera cannot be displayed as a sequence.

### **📎** Playback Menu Options Available When Using Sequence

- When images in a sequence are displayed in full-frame playback mode, press the **MENU** button to select functions in playback menu (**74**).
- If you press the **MENU** button when a key picture is displayed, the following settings can be applied to all images in the sequence:
  - Favorite pictures, Print order, Protect, Copy

## Deleting Images in a Sequence

When the  button is pressed for images in a sequence, the images that are deleted vary depending on how the sequences are displayed.

- When the key picture is displayed:
  - **Current image:** All images in the displayed sequence are deleted.
  - **Erase selected images:** When a key picture is selected on the erase selected images screen (30), all images in that sequence are deleted.
  - **All images:** All images in the internal memory or on the memory card are deleted.
- When images in a sequence are displayed in full-frame playback mode:
  - **Current image:** The image currently displayed is deleted.
  - **Erase selected images:** Images that are selected in the sequence are deleted.
  - **Entire sequence:** All images in the displayed sequence are deleted.

# Editing Still Images

## Before Editing Images

You can easily edit images on this camera. Edited copies are saved as separate files.

Edited copies are saved with the same shooting date and time as the original.



### **Restrictions on Image Editing**

An image can be edited up to ten times.

## Quick Effects: Changing Hue or Mood

Quick effects option	Description
Pop and Super vivid	Mainly enhances the color saturation.
Painting, High key, Toy camera effect 1, Toy camera effect 2, Low key, Cross process (red), Cross process (yellow), Cross process (green), and Cross process (blue)	Mainly adjusts hue and creates a different look for the image.
Soft, Soft portrait, Fisheye, Cross screen, and Miniature effect	Processes images with a variety of effects.
High-contrast monochrome, Sepia, Cyanotype, and Selective color	Turns multicolor images into single color images. Selective color transforms all colors, except a specified color, to black and white.

- 1 Display the image to which you want to apply an effect in full-frame playback mode and press the **OK** button.



- 2 Use the multi selector **◀▶** or rotate it to select the desired effect and press the **OK** button.

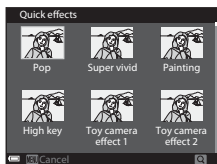

- Move the zoom control (**1**) toward **T** (**Q**) to display a confirmation dialog for the applied effect. Move the zoom control toward **W** (**⊞**) to return to the selection screen for effects.
- To exit without saving the edited image, press the **MENU** button.



- 3 Select **Yes** and press the **OK** button.

- An edited copy is created.

## Quick Retouch: Enhancing Contrast and Saturation



Press the  button (playback mode) → select an image → MENU button → Quick retouch →  button

Use the multi selector ▲▼ to select the amount of effect applied and press the  button.

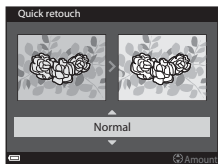
- The edited version is displayed on the right.
- To exit without saving the copy, press ◀.



## D-Lighting: Enhancing Brightness and Contrast



Press the  button (playback mode) → select an image → MENU button → D-Lighting →  button

Use the multi selector ▲▼ to select **OK** and press the  button.

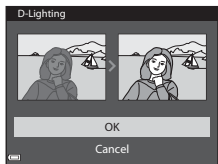
- The edited version is displayed on the right.
- To exit without saving the copy, select **Cancel** and press the  button.



## Red-eye Correction: Correcting Red-eye When Shooting with the Flash

Press the  button (playback mode) → select an image → MENU button → Red-eye correction →  button

Preview the result and press the  button.

- To exit without saving the copy, press the multi selector .

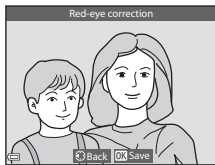

### Notes About Red-eye Correction

- Red-eye correction can only be applied to images when red-eye is detected.
- Red-eye correction can be applied to pets (dogs or cats) even if their eyes are not red.
- Red-eye correction may not produce the desired results in some images.
- In some rare cases, red-eye correction may be applied unnecessarily to other areas of the image.

# Glamour Retouch: Enhancing Human Faces

Press the button (playback mode) → select an image → MENU button → Glamour retouch → button

**1** Use the multi selector to select the face that you want to retouch and press the button.

- When only one face is detected, proceed to step 2.

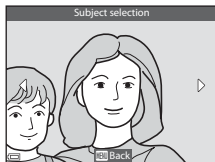

**2** Use to select the effect, use to select the effect level, and press the button.

- You can simultaneously apply multiple effects.

Adjust or check the settings for all effects before pressing the button.

(small face), (skin softening), (powder), (glare reduction), (hide eye bags), (big eyes), (whiten eyes), (eye shadow), (mascara), (whiten teeth), (lipstick), (redden cheeks)

- Press the MENU button to return to the screen for selecting a face.



**3** Preview the result and press the button.

- To change the settings, press to return to step 2.
- To exit without saving the edited image, press the MENU button.



**4** Select **Yes** and press the button.

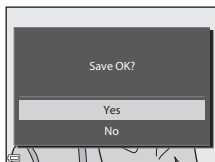

- An edited copy is created.



## ✓ Notes About Glamour Retouch

- Only one face can be edited at a time using the glamour retouch function. The function can be used for up to ten faces (up to ten times) on the same image if you edit a different face each time.
- Depending upon the direction in which faces are looking, or the brightness of faces, the camera may be unable to accurately detect faces, or the glamour retouch function may not perform as expected.
- If no faces are detected, a warning is displayed and the screen returns to the playback menu.
- The glamour retouch function is available only for images captured when the ISO sensitivity is 1600 or lower.

## Small Picture: Reducing the Size of an Image

Press the  button (playback mode) → select an image → MENU button → Small picture →  button

**1** Use the multi selector ▲▼ to select the desired copy size and press the  button.

- Images taken at an image size setting of  $\frac{16:9}{12M}$  **4608x2592** are saved at 640 x 360 pixels. Proceed to step 2.

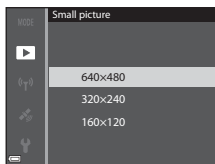

**2** Select **Yes** and press the  button.

- An edited copy is created (compression ratio of approximately 1:8).

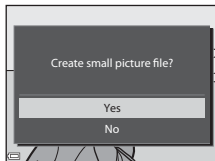

## ✓ Notes About Small Picture





Images at a 1:1 aspect ratio cannot be edited.



## Crop: Creating a Cropped Copy

**1** Move the zoom control to enlarge the image (72).

**2** Refine copy composition and press the **MENU** button.

- Move the zoom control toward **T** () or **W** () to adjust the zoom ratio. Set a zoom ratio at which **MENU**: is displayed.
- Use the multi selector  to scroll the image so that only the portion to be copied is visible in the monitor.



**3** Select **Yes** and press the **OK** button.

- An edited copy is created.



### **Image Size**

When the image size of the cropped copy is 320 × 240 or smaller, the image is displayed at a smaller size during playback.

### **Cropping the Image in Its Current “Tall” Orientation**

Use the **Rotate image** option (51) to rotate the image so that it is displayed in landscape orientation. After cropping the image, rotate the cropped image back to “tall” orientation.

# Connecting the Camera to a TV (Viewing Images on a TV)

## 1 Turn off the camera and connect it to the TV.

- Make sure that the plugs are properly oriented. Do not insert or remove the plugs at an angle when connecting or disconnecting them.

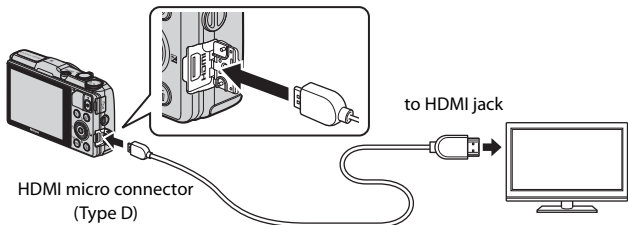

## 2 Set the TV's input to external input.

- See the documentation provided with your TV for details.

## 3 Hold down the button to turn on the camera.

- Images are displayed on the TV.
- The camera monitor does not turn on.

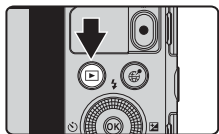

### Using a TV Remote Control (HDMI Device Control)

The remote control of an HDMI-CEC-compatible TV can be used to select images, start and pause movie playback, switch between full-screen playback mode and four-image thumbnail display, etc.

- Set the **HDMI device control** setting ( 74) of **TV settings** to **On** (default setting) and then connect the camera and TV using an HDMI cable.
- Aim the remote control at the TV when operating it.

## Connecting the Camera to a Printer (Direct Print)

Users of PictBridge-compatible printers can connect the camera directly to the printer and print images without using a computer.

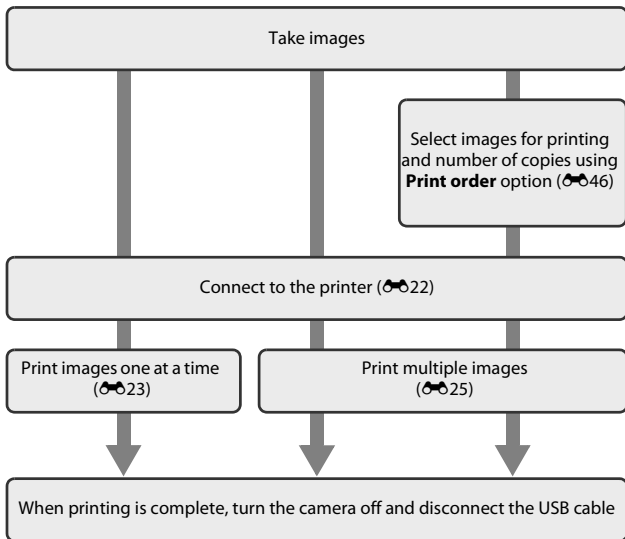

## Connecting the Camera to a Printer

- 1 Turn off the camera.
- 2 Turn on the printer.
  - Check printer settings.
- 3 Connect the camera to the printer using the USB cable.
  - Make sure that the plugs are properly oriented. Do not insert or remove the plugs at an angle when connecting or disconnecting them.

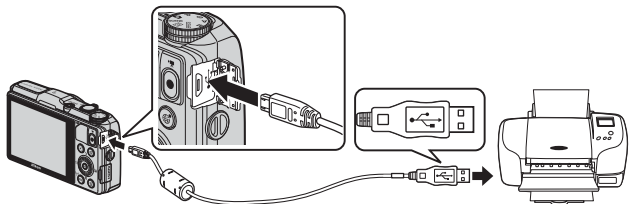

- 4 The camera is automatically turned on.
  - The **PictBridge** startup screen (①) is displayed in the camera monitor, followed by the **Print selection** screen (②).

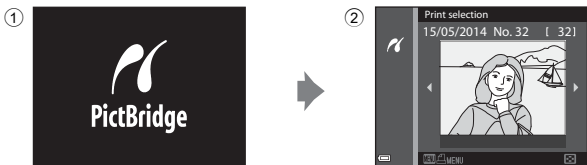

### ✓ If the PictBridge Startup Screen Is not Displayed

When **Auto** is selected for **Charge by computer** (0675), it may be impossible to print images with direct connection of the camera to some printers. If the PictBridge startup screen is not displayed after the camera is turned on, turn the camera off and disconnect the USB cable. Set **Charge by computer** to **Off** and reconnect the camera to the printer.

## Printing Individual Images

**1** Use the multi selector to select the desired image and press the **OK** button.

- Move the zoom control toward **W** (📐) to switch to thumbnail playback or **T** (🔍) to switch to full-frame playback.

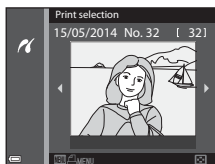

**2** Use **▲▼** to select **Copies** and press the **OK** button.

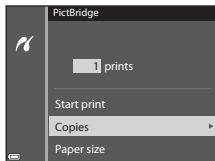

**3** Select the desired number of copies (up to 9) and press the **OK** button.



**4** Select **Paper size** and press the **OK** button.

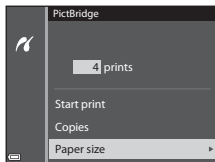

**5** Select the desired paper size and press the **OK** button.

- To apply the paper size setting configured on the printer, select **Default** as the paper size option.
- The paper size options available on the camera vary depending on the printer that you use.

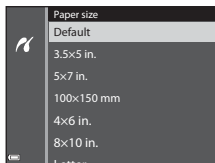

**6** Select **Start print** and press the **OK** button.

- Printing starts.
- To cancel printing, press the **OK** button.

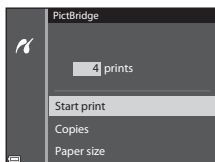

## Printing Multiple Images

- 1 When the **Print selection** screen is displayed, press the **MENU** button.

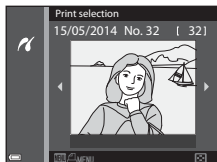

- 2 Use the multi selector ▲▼ to select **Paper size** and press the **OK** button.

- To exit the print menu, press the **MENU** button.

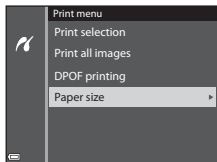

- 3 Select the desired paper size and press the **OK** button.

- To apply the paper size setting configured on the printer, select **Default** in the paper size option.
- The paper size options available on the camera vary depending on the printer that you use.

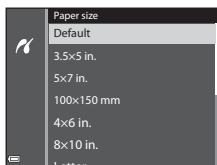

- 4 Select **Print selection**, **Print all images**, or **DPOF printing** and press the **OK** button.

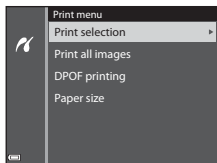

## Print selection

Select images (up to 99) and the number of copies (up to 9) of each.

- Use the multi selector ◀▶ to select images, and use ▲▼ to specify the number of copies to be printed.
- Images selected for printing are indicated by 🖨️ and the numeral indicating the number of copies to be printed. If no copies have been specified for images, the selection is canceled.
- Move the zoom control toward **T** (🔍) to switch to full-frame playback or **W** (🖼️) to switch to thumbnail playback.
- Press the **OK** button when setting is complete.
- When the screen shown on the right is displayed, select **Start print** and press the **OK** button to start printing.

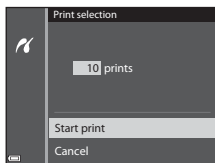

## Print all images

One copy each of all images saved in the internal memory, or on the memory card, is printed.

- When the screen shown on the right is displayed, select **Start print** and press the **OK** button to start printing.

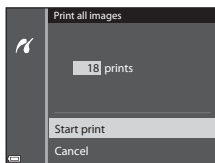

## DPOF printing

Print images for which a print order was created using the **Print order** option (📄46).

- When the screen shown on the right is displayed, select **Start print** and press the **OK** button to start printing. To view the current print order, select **View images** and press the **OK** button. To print images, press the **OK** button again.

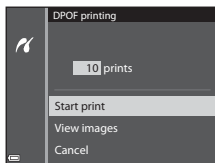



## Editing Movies

### Extracting Only the Desired Portion of a Movie

The desired portions of a recorded movie can be saved as a separate file.

**1** Play back the desired movie and pause at the start point of the portion that is to be extracted (📖81).

**2** Use the multi selector ◀▶ to select 🎞️ in the playback controls, and then press the Ⓞ button.

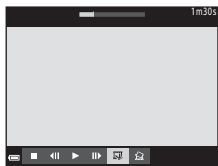

**3** Use ▲▼ to select ✂️ (Choose start point) in the editing controls.

- Use the multi selector ◀▶ or rotate it to move the start point.
- To cancel editing, select ↶ (Back), and press the Ⓞ button.

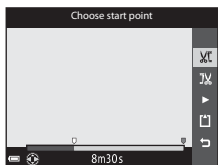

**4** Use ▲▼ to select 🎞️ (Choose end point).

- Use the multi selector ◀▶ or rotate it to move the end point.
- To preview the specified portion, select ▶ and then press the Ⓞ button. Press the Ⓞ button again to stop previewing.

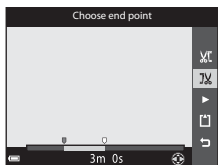

**5** Use ▲▼ to select 📁 (Save) and press the Ⓞ button.

- Follow the instructions on the screen to save the movie.



## ✓ Notes About Movie Editing

- Use a sufficiently charged battery to prevent the camera from turning off during editing.
- A movie that was created by editing cannot be trimmed again.
- The actual trimmed portion of a movie may differ slightly from the portion selected using the start and end points.
- Movies cannot be trimmed so that they are less than two seconds long.

## Saving a Frame from a Movie as a Still Image

The desired frame of a recorded movie can be extracted and saved as a still image.

- Pause a movie and display the frame to be extracted (📖82).
- Use the multi selector ◀▶ to select the 📷 control and press the Ⓞ button.

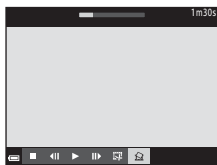

- Select **Yes** when a confirmation dialog is displayed, and press the Ⓞ button to save the image.
- The image quality of the saved still image is **Normal**. The image size is determined by the type (image size) (🔑55) of the original movie. For example, a still image saved from a movie recorded with  $\frac{1080}{60} \text{p}$  **1080/30p** or  $\frac{1080}{25} \text{p}$  **1080/25p** is  $\frac{1080}{24}$  (1920 × 1080 pixels).

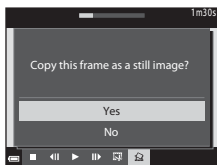

## ✓ Notes About Saving Still Images

Frames of movies recorded with  $\frac{1080}{60} \text{i}$  **1080/60i** or  $\frac{1080}{50} \text{i}$  **1080/50i**, or  $\frac{480}{60} \text{p}$  **480/30p** or  $\frac{480}{25} \text{p}$  **480/25p**, and HS movies (🔑55) cannot be saved as still images.

# The Common Shooting Options (Image Quality and Image Size)

## Image Quality

Enter shooting mode → MENU button → Image quality → OK button

Set the image quality (compression ratio) used when saving images. Lower compression ratios result in higher quality images, but the number of images that can be saved is reduced.

Option		Description
<b>FINE</b>	Fine	Finer image quality than <b>Normal</b> . Compression ratio: Approx. 1:4
<b>NORM</b>	Normal (default setting)	Normal image quality, suitable for most applications. Compression ratio: Approx. 1:8



### Image Quality Setting

- The image quality can be set in any shooting mode. The setting is also applied to other shooting modes.
- The setting may not be changed when using certain settings of other functions.



### Number of Images That Can Be Saved







- The approximate number of images that can be saved can be checked in the monitor when shooting (📖20).
- Note that due to JPEG compression, the number of images that can be saved may vary greatly depending on the image content, even when using memory cards with the same capacity and the same image quality and image size settings. In addition, the number of images that can be saved may vary depending on the make of the memory card.
- If the number of exposures remaining is 10,000 or more, the number of exposures remaining display shows "9999".

# Image Size

Enter shooting mode → MENU button → Image size →  button

Set the image size (number of pixels) used when saving images.

The larger the image size, the larger the size at which it can be printed, but the number of images that can be saved is reduced.

Option*	Aspect ratio (horizontal to vertical)
 4608×3456 (default setting)	4:3
 3264×2448	4:3
 2272×1704	4:3
 1600×1200	4:3
 640×480	4:3
 4608×2592	16:9
 3456×3456	1:1

\* The total number of pixels captured, and the number of pixels captured horizontally and vertically.

Example:  **4608×3456** = approx. 16 megapixels, 4608 × 3456 pixels



## Image Size Setting

- The image size can be set in any shooting mode. The setting is also applied to other shooting modes.
- The setting may not be changed when using certain settings of other functions.



## Printing Images of Size 1:1

Change the printer setting to "Border". The images may not be printed in 1:1 ratio depending on the printer.

## The Shooting Menu (P, S, A, or M Mode)

- See “Image Quality” (📷29) and “Image Size” (📷30) for information about **Image quality** and **Image size**.

### White Balance (Adjusting Hue)

Select **P, S, A, or M** mode → MENU button → **P, S, A, or M** menu icon → White balance → ⓧ button

Adjust white balance to suit the light source or weather conditions in order to make the colors in images match what you see with your eyes.

- Use **Auto** under most conditions. Change the setting when you want to adjust the hue of the image you are taking.

Option	Description
<b>AUTO</b> Auto (default setting)	White balance is automatically adjusted to suit lighting conditions.
<b>PRE</b> Preset manual	Use when the desired result is not achieved with <b>Auto</b> , <b>Incandescent</b> , etc. (📷32).
☀️ Daylight	White balance adjusted for direct sunlight.
💡 Incandescent	Use under incandescent lighting.
💡 Fluorescent	Use under fluorescent lighting.
☁️ Cloudy	Use when taking images under overcast skies.
⚡ Flash	Use with the flash.

#### ✓ Notes About White Balance

- Set the flash to ⓧ (off) when white balance is set to any setting other than **Auto** and **Flash** (📷50).
- The setting may not be changed when using certain settings of other functions.

## Using Preset Manual

Use the procedure below to measure the white balance value under the lighting used during shooting.

**1** Place a white or gray reference object under the lighting that will be used during shooting.

**2** Use the multi selector ▲▼ to select **Preset manual** in the **White balance** menu, and press the **OK** button.

- The camera zooms in to the position for measuring white balance.

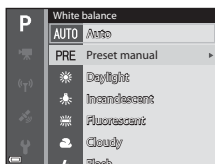

**3** Select **Measure**.

- To apply the last measured value, select **Cancel** and press the **OK** button.

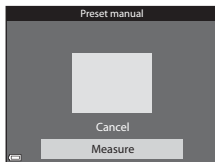

**4** Frame the reference object in the measuring window.

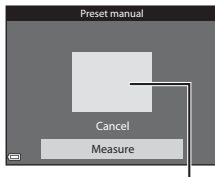

Measuring window

**5** Press the **OK** button to measure the value.

- The shutter is released and measurement is complete. No image is saved.

### ✓ Notes About Preset Manual



A value for flash lighting cannot be measured with **Preset manual**. When shooting using the flash, set **White balance** to **Auto** or **Flash**.

# Metering

Select **P**, **S**, **A**, or **M** mode → MENU button → **P**, **S**, **A**, or **M** menu icon → Metering → 

The process of measuring the brightness of the subject to determine the exposure is known as “metering.”

Use this option to set the method of how the camera meters exposure.

Option	Description
 <b>Matrix</b> (default setting)	The camera uses a wide area of the screen for metering. Recommended for typical shooting.
 <b>Center-weighted</b>	The camera meters the entire frame but assigns greatest weight to the subject in the center of the frame. The classic metering for portraits; it preserves background details while letting lighting conditions in the center of the frame determine exposure. Can be used with focus lock (  71) to meter off-center subjects.

## Notes About Metering











- When digital zoom is in effect, **Center-weighted** or spot metering (where the center of the frame is metered) is selected depending on the magnification of an enlargement.
- The setting may not be changed when using certain settings of other functions.

## Metering Area





When **Center-weighted** is selected for **Metering**, the metering range guide (7) is displayed (except when digital zoom is used).

## Continuous Shooting

Select **P**, **S**, **A**, or **M** mode → MENU button → **P**, **S**, **A**, or **M** menu icon → Continuous →  button

Option	Description
 Single (default setting)	One image is taken each time the shutter-release button is pressed.
 Continuous H	While the shutter-release button is held all the way down, images are captured continuously. <ul style="list-style-type: none"><li>The frame rate for continuous shooting is about 6.9 fps and the maximum number of continuous shots is about 5 (when image quality is set to <b>Normal</b> and when image size is set to  <b>4608x3456</b>).</li></ul>
 Continuous L	While the shutter-release button is held all the way down, images are captured continuously. <ul style="list-style-type: none"><li>The frame rate for continuous shooting is about 2.2 fps and the maximum number of continuous shots is about 36 (when image quality is set to <b>Normal</b> and when image size is set to  <b>4608x3456</b>).</li></ul>
 Pre-shooting cache	When the shutter-release button is pressed halfway, pre-shooting cache shooting begins. When the shutter-release button is pressed the rest of the way down, the camera saves the current image as well as the images captured immediately before the button is pressed (  36). This function helps you to avoid missing the shot. <ul style="list-style-type: none"><li>The frame rate for continuous shooting is about 20 fps and the maximum number of continuous shots is 25, including a maximum of 5 frames captured in the pre-shooting cache.</li><li>The image quality is fixed at <b>Normal</b> and the image size is fixed at  (1280 × 960 pixels).</li></ul>
 120 Continuous H: 120 fps	Each time the shutter-release button is pressed all the way, images are captured at a high speed rate. <ul style="list-style-type: none"><li>The frame rate for continuous shooting is about 120 fps and the maximum number of continuous shots is 50.</li><li>The image quality is fixed at <b>Normal</b> and the image size is fixed at  <b>640x480</b>.</li></ul>



Option	Description
 <b>60 Continuous H: 60 fps</b>	<p>Each time the shutter-release button is pressed all the way, images are captured at a high speed rate.</p> <ul style="list-style-type: none"> <li>• The frame rate for continuous shooting is about 60 fps and the maximum number of continuous shots is 25.</li> <li>• The image quality is fixed at <b>Normal</b> and the image size is fixed at  (1280 × 960 pixels).</li> </ul>
<b>BSS BSS</b> (Best Shot Selector)	<p>While the shutter-release button is held all the way down, the camera captures a series of up to 10 images and automatically saves the sharpest image.</p> <p>Use when shooting a stationary subject in a place where flash photography is prohibited and camera shake is likely to occur.</p>
 <b>Multi-shot 16</b>	<p>Each time the shutter-release button is pressed all the way down, the camera captures a series of 16 images and saves it as a single image.</p>  <ul style="list-style-type: none"> <li>• The frame rate for continuous shooting is about 30 fps.</li> <li>• The image quality is fixed at <b>Normal</b> and the image size is fixed at  (2560 × 1920 pixels).</li> <li>• Digital zoom cannot be used.</li> </ul>

### **Notes About Continuous Shooting**

- Focus, exposure, and white balance are fixed at the values determined with the first image in each series.
- It may take some time to save the images after shooting.
- When ISO sensitivity increases, noise may appear in captured images.
- The frame rate for continuous shooting may become slow depending upon the current image quality setting, image size setting, the memory card used, or shooting condition.
- When using **Pre-shooting cache**, **Continuous H: 120 fps**, **Continuous H: 60 fps**, or **Multi-shot 16**, banding or variance in brightness or hue may occur in images that were captured under lighting that flickers at high speeds, such as fluorescent, mercury-vapor, or sodium-vapor lighting.

## Pre-shooting Cache

When the shutter-release button is pressed halfway or all the way down, images are saved in the manner described below.

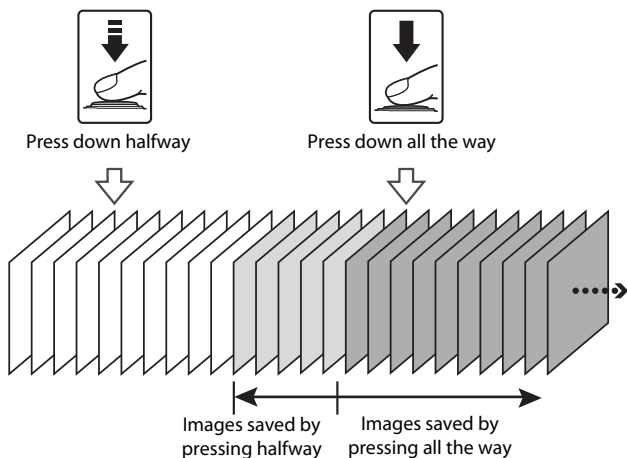

- The pre-shooting cache icon () in the monitor glows green while the shutter-release button is pressed halfway.

## ISO Sensitivity

Select **P**, **S**, **A**, or **M** mode → MENU button → **P**, **S**, **A**, or **M** menu icon → ISO sensitivity →  button

Higher ISO sensitivity allows darker subjects to be captured. Additionally, even with subjects of similar brightness, images can be taken at faster shutter speeds, and blurring caused by camera shake and subject movement can be reduced.

- When higher ISO sensitivity is set, images may contain noise.

Option	Description
<b>AUTO</b> Auto (default setting)	Sensitivity is automatically selected from the range of ISO 125 to 1600.
 Fixed range auto	Select the range in which the camera automatically adjusts ISO sensitivity, from <b>ISO 125-400</b> or <b>ISO 125-800</b> .
125, 200, 400, 800, 1600, 3200, 6400	Sensitivity is locked at the specified value.

### Notes About ISO Sensitivity

The setting may not be changed when using certain settings of other functions.



### ISO Sensitivity Display on the Shooting Screen



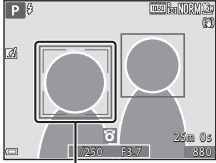
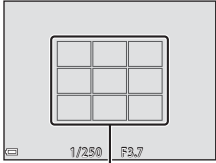

- When **Auto** is selected, **ISO** is displayed if the ISO sensitivity automatically increases.
- When **Fixed range auto** is selected, the maximum value for ISO sensitivity is displayed.

## AF Area Mode

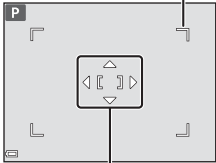
Select **P**, **S**, **A**, or **M** mode → MENU button → **P**, **S**, **A**, or **M** menu icon → AF area mode → **OK** button

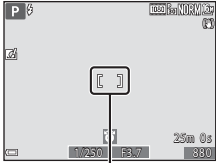
Use this option to determine how the camera selects the focus area for autofocus when shooting still images.

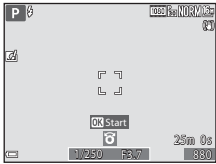
Option	Description
<p> Face priority</p>	<p>When the camera detects a human face, it focuses on that face. See “Using Face Detection” (📖69) for more information.</p>  <p>Focus area</p> <p>When framing a composition with no human subjects or detected faces, the camera automatically selects one or more of the 9 focus areas containing the subject closest to the camera when the shutter-release button is pressed halfway.</p>  <p>Focus areas</p>
<p> Manual</p>	<p>Use the multi selector  to move the focus area to where you want to focus.</p> <ul style="list-style-type: none"> <li>To use the multi selector to configure the flash mode or other settings, press the <b>OK</b> button. To return to moving the focus area, press the <b>OK</b> button again.</li> </ul> <p>Scope of movable focus area</p>  <p>Focus area</p>

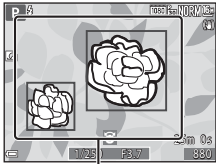
Option	Description	
<p>[▪] Center</p>	<p>The camera focuses on the subject in the center of the frame.</p>	 <p>The image shows a camera viewfinder with a central focus area bracket. The camera is in Program mode (P). The viewfinder displays various settings: 1/250, F3.7, 25m 0s, and 880. A bracket is centered on the frame, and a line points from the text 'Focus area' below to it.</p>
<p> Subject tracking</p>	<p>Use this function to take images of moving subjects. Register the subject on which the camera focuses. The focus area automatically moves to track the subject. See “Using Subject Tracking” (📖40) for more information.</p>	 <p>The image shows a camera viewfinder with a subject tracking focus area. The camera is in Program mode (P). The viewfinder displays various settings: 1/250, F3.7, 25m 0s, and 880. A focus area is shown, and a line points from the text 'Focus area' below to it.</p>
<p> Target finding AF (default setting)</p>	<p>When the camera detects the main subject, it focuses on that subject. See “Using Target Finding AF” (📖68) for more information.</p>	 <p>The image shows a camera viewfinder with target finding AF focus areas. The camera is in Program mode (P). The viewfinder displays various settings: 1/250, F3.7, 25m 0s, and 880. Two focus areas are shown, one larger than the other, and a line points from the text 'Focus areas' below to them.</p>

### Notes About AF Area Mode

- When digital zoom is in effect, the camera focuses on the area in the center of the frame regardless of the **AF area mode** setting.
- The setting may not be changed when using certain settings of other functions.

### AF Area Mode for Movie Recording

AF area mode for movie recording can be set with **AF area mode** (📖59) in the movie menu.

## Using Subject Tracking

Select **P**, **S**, **A**, or **M** mode → MENU button → **P**, **S**, **A**, or **M** menu icon → AF area mode → OK button →  Subject tracking → OK button → MENU button

### 1 Register a subject.

- Align the subject that you want to track with the border in the center of the monitor and press the OK button.
- When the subject is registered, a yellow border (focus area) is displayed around that subject and the camera begins tracking that subject.
- If the subject cannot be registered, the border glows red. Change the composition and try registering the subject again.
- To cancel subject registration, press the OK button.
- If the camera can no longer track the registered subject, the focus area disappears. Register the subject again.

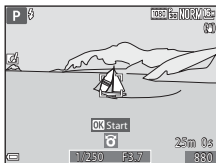

### 2 Press the shutter-release button fully to take the picture.

- If the shutter-release button is pressed while the focus area is not displayed, the camera focuses on the subject in the center of the frame.



### ✓ Notes About Subject Tracking

- If you perform operations such as zooming while the camera is tracking the subject, the registration is canceled.
- Subject tracking may not be possible in certain shooting conditions.

## Autofocus Mode

Select **P**, **S**, **A**, or **M** mode → MENU button → **P**, **S**, **A**, or **M** menu icon → Autofocus mode →  button

Select how the camera focuses when shooting still images.

Option	Description
<b>AF-S</b> Single AF	The camera focuses only when the shutter-release button is pressed halfway.
<b>AF-F</b> Full-time AF	The camera continues focusing even when the shutter-release button is not pressed halfway. The sound of lens drive movement is heard while the camera focuses.
<b>PRE-AF</b> Pre-focus (default setting)	Even when the shutter-release button is not pressed halfway, the camera focuses automatically if the composition of the framed image is significantly changed.





### Autofocus Mode for Movie Recording

Autofocus mode for movie recording can be set with **Autofocus mode** () in the movie menu.

## Quick Effects

Select **P**, **S**, **A**, or **M** mode → MENU button → **P**, **S**, **A**, or **M** menu icon → Quick effects →  button

Option	Description
 On (default setting)	In <b>P</b> , <b>S</b> , <b>A</b> , or <b>M</b> mode, press the  button immediately after releasing the shutter to display the effect selection screen and use the quick effects function (  44).
Off	Disables the quick effects function (during shooting).



### Notes About Quick Effects

The setting may not be changed when using certain settings of other functions.

## M Exposure Preview

Select **P**, **S**, **A**, or **M** mode → MENU button → **P**, **S**, **A**, or **M** menu icon → M exposure preview →  button

Select whether or not changes in the brightness are also reflected on the shooting screen when the exposure is changed in **M** (manual) mode.

Option	Description
On (default setting)	Changes in the brightness are reflected on the shooting screen.
Off	Changes in the brightness are not reflected on the shooting screen.



## The Smart Portrait Menu

- See “Image Quality” (📷29) and “Image Size” (📷30) for information about **Image quality** and **Image size**.

---



### Skin Softening

Select smart portrait mode → MENU button → 😊 menu icon → Skin softening → Ⓜ button





Option	Description
⬆️⬆️ High	When the shutter is released, the camera detects one or more human faces (up to 3), and processes the image to soften facial skin tones before saving the image. You can select the amount of effect that is applied.
⬆️⬆️ Normal (default setting)	
⬆️ Low	
Off	Turns skin softening off.

The effects of skin softening are not visible when framing images for shooting. Check the results in playback mode, after taking images.

## Smile Timer

Select smart portrait mode → MENU button →  menu icon → Smile timer → 



The camera detects human faces and then automatically releases the shutter whenever a smile is detected.

Option	Description
 On (single) (default setting)	Whenever a smile is detected, the camera captures one image.
  On (continuous)	Whenever a smile is detected, the camera captures up to 5 images continuously and saves them all.
 <b>BSS</b> On (BSS)	Whenever a smile is detected, the camera captures up to 5 images continuously and saves the one that best captured the smile.
Off	Turns the smile timer off.

### Notes About Smile Timer

The setting may not be changed when using certain settings of other functions.

## Blink Proof

Select smart portrait mode → MENU button →  menu icon → Blink proof →  button

Option	Description
 On	<p>The camera automatically releases the shutter twice with every shot and saves one image in which the subject's eyes are open.</p> <ul style="list-style-type: none"><li>• If the camera saved an image in which the subject's eyes may have been closed, the dialog shown on the right is displayed for a few seconds.</li></ul>
Off (default setting)	Turns the blink proof off.

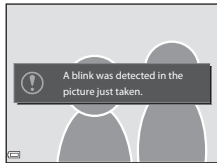



### Notes About Blink Proof

The setting may not be changed when using certain settings of other functions.

## The Playback Menu

- See “Editing Still Images” (📷13) for information about image editing functions.
- See “Favorite Pictures Mode” (📷5) for information about **Favorite pictures** and **Remove from favorites**.

### Print Order (Creating a DPOF Print Order)

Press the  button (playback mode) → MENU button → Print order →  button

If you configure print order settings in advance, you can use them with the printing methods listed below.

- Taking the memory card to a digital photo lab that supports DPOF (Digital Print Order Format) printing.
- Inserting the memory card into a DPOF-compatible printer’s card slot.
- Connecting the camera to a PictBridge-compatible printer (📷21).

**1** Use the multi selector ▲▼ to select **Select images** and press the  button.

- In favorite pictures, auto sort, or list by date mode, the screen shown on the right is not displayed. Proceed to step 2.

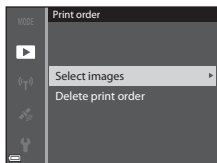

## 2 Select images (up to 99) and the number of copies (up to 9) of each.

- Use the multi selector ◀▶ to select images, and use ▲▼ to specify the number of copies to be printed.
- Images selected for printing are indicated by  and the numeral indicating the number of copies to be printed. If no copies have been specified for images, the selection is canceled.
- Move the zoom control toward **T** (Q) to switch to full-frame playback or **W** (R) to switch to thumbnail playback.
- Press the **OK** button when setting is complete.



## 3 Select whether or not to print shooting date and shooting information.

- Select **Date** and press the **OK** button to print the shooting date on all images.
- Select **Info** and press the **OK** button to print the shutter speed and aperture value on all images.
- Lastly, select **Done** and press the **OK** button to complete the print order.

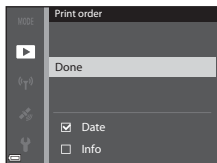

### ✓ Notes About Printing Shooting Date and Shooting Information

- Some printers may not be able to print the shooting date and shooting information.
- Shooting information is not printed when the camera is connected to a printer.
- The **Date** and **Info** settings are reset each time the **Print order** option is displayed.
- The date printed is that saved when the image was captured.
- For images taken with the **Print date** (68) option enabled, only the date imprinted at the time of shooting is printed, even if the **Print order** date option is enabled for the images.



## ✓ Notes About Print Order

When a print order is created in favorite pictures mode, auto sort mode, or list by date mode, the screen shown below is displayed if images other than those in the selected album, category, or shooting date have been marked for printing.

- **Yes:** Does not remove print markings from other images, and adds the current print order settings.
- **No:** Removes print markings from all other images, and uses only the current print order settings.

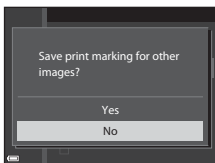

Favorite pictures mode or auto sort mode

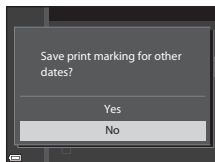

List by date mode

If the total number of the images in the print order exceeds 99 when the new settings are applied, the screen shown below is displayed.

- **Yes:** Removes print markings from all other images, and uses only the current print order settings.
- **Cancel:** Does not remove print markings from other images, and cancels the current print order settings.

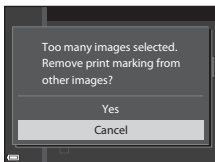

Favorite pictures mode or auto sort mode

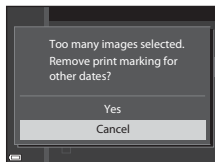

List by date mode



## 📎 Canceling Existing Print Order

Select **Delete print order** in step 1 (🔍46) of "Print Order (Creating a DPOF Print Order)".

## 📎 More Information



See "Printing Images of Size 1:1" (🔍30) for more information.

## Slide Show

Press the  button (playback mode) → MENU button → Slide show →  button



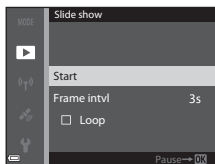

Play back images one by one in an automated “slide show.” When movie files are played back in the slide show, only the first frame of each movie is displayed.

### 1 Use the multi selector to select **Start** and press the button.

- The slide show begins.
- To change the interval between images, select **Frame intvl**, press the  button, and specify the desired interval time before selecting **Start**.
- To repeat the slide show automatically, select **Loop** and press the  button before selecting **Start**.
- The maximum playback time is up to about 30 minutes even if **Loop** is enabled.





### 2 Select End or Restart.



- The screen shown on the right is displayed after the slide show ends or is paused. To exit the show, select  and then press the  button. To resume the slide show, select  and then press the  button.



## Operations During Playback

- Use   to display the previous/next image. Press and hold to rewind/fast forward.
- Press the  button to pause or end the slide show.

## Protect

Press the  button (playback mode) → MENU button → Protect →  button

The camera protects selected images from accidental deletion.

Select images to protect or cancel protection for previously protected images from the image selection screen (50).



Note that formatting the camera's internal memory or the memory card permanently deletes protected files (73).

### The Image Selection Screen

When an image selection screen such as the one shown on the right is displayed while operating the camera, follow the procedures described below to select the images.



#### 1 Use the multi selector to select an image.

- Move the zoom control (1) toward **T** () to switch to full-frame playback or **W** () to switch to thumbnail playback.
- Only one image can be selected for **Rotate image**, **Choose key picture**, and **Welcome screen**. Proceed to step 3.



#### 2 Use to select or deselect (or to specify the number of copies).

- When an image is selected, an icon is displayed below the image. Repeat steps 1 and 2 to select additional images.





#### 3 Press the button to apply image selection.



- When **Selected images** is selected, a confirmation dialog is displayed. Follow the instructions displayed in the monitor.



## Rotate Image

Press the  button (playback mode) → MENU button → Rotate image →  button

Specify the orientation in which saved images are displayed during playback. Still images can be rotated 90 degrees clockwise or 90 degrees counterclockwise.

Select an image from the image selection screen (50). When the Rotate image screen is displayed, use the multi selector  or rotate it to rotate the image 90 degrees.



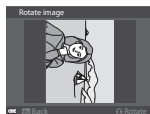

Rotate 90 degrees counterclockwise



Rotate 90 degrees clockwise





Press the  button to finalize display orientation, and save orientation information with the image.

## Voice Memo

Press the  button (playback mode) → select an image → MENU button → Voice memo →  button

Voice memos can be recorded and attached to images.

### Recording Voice Memos

- Press and hold the  button to record (up to about 20 seconds).
- Do not touch the microphones.
- During recording, **REC** and  flash in the monitor.
- The voice memo playback screen is displayed after recording ends. Press the  button to play back the voice memo.
- Delete the current voice memo before recording a new voice memo (52).
-  is displayed for images with a voice memo when in full-frame playback mode.







### Playing Voice Memos

Select an image with  displayed before pressing the MENU button.

- Press the  button to play the voice memo. Press the button again to stop playback.
- Move the zoom control during playback to adjust playback volume.





### Deleting Voice Memos

Press the  button while the screen described in "Playing Voice Memos" (52) is displayed. When the confirmation dialog is displayed, use the multi selector   to select **Yes** and press the  button.

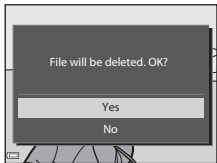

- To delete a voice memo for a protected image, the **Protect** setting must first be disabled.





# Copy (Copy Between Internal Memory and Memory Card)

Press the  button (playback mode) → MENU button → Copy →  button

Copy images between the internal memory and a memory card.

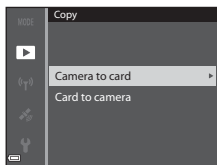
- 1 Use the multi selector   to select a destination option to which images are copied and press the  button.



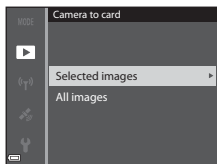

- 2 Select a copy option and press the  button.

- If you choose the **Selected images** option, use the image selection screen to specify images (50).
- If you choose the **Card to camera** option, the All images option is not available.



## Notes About Copying Images

- Only files in formats that this camera can record can be copied.
- Operation is not guaranteed with images captured with another make of camera or that have been modified on a computer.
- The **Print order** (46) settings configured for images are not copied.
- Copied images or movies cannot be displayed in auto sort mode (9).
- If an image added to an album (5) is copied, the copied image is not added to the album.



## Notes About Copying Images in a Sequence



- If you select a key picture of a sequence in **Selected images**, all images in the sequence are copied.
- If you press the **MENU** button while images in a sequence are displayed, only the **Card to camera** copy option is available. All images in the sequence are copied if you select **Current sequence**.







## Copying to a Memory Card That Contains No Images

When the camera is switched to playback mode, **Memory contains no images** is displayed. Press the **MENU** button to select **Copy**.

## Sequence Display Options



Press the  button (playback mode) → **MENU** button → Sequence display options →  button

Select the method used to display images in the sequence (11).

Option	Description
 Individual pictures	Displays each image in a sequence individually.  is displayed on the playback screen.
 Key picture only (default setting)	Displays only the key picture for images in a sequence.

Settings are applied to all sequences, and the setting is saved in the camera's memory even if the camera is turned off.

## Choose Key Picture



Press the  button (playback mode) → display a sequence for which you want to change the key picture → **MENU** button → Choose key picture →  button

Specify a different image in the sequence as the key picture.

- When the key picture selection screen is displayed, select an image (50).

# The Movie Menu

## Movie Options











Enter shooting mode → MENU button →  menu icon → Movie options  
→  button

Select the desired movie option to record.

Select normal speed movie options to record at normal speed, or HS movie options () to record in slow or fast motion.

- Memory cards (Class 6 or higher) are recommended for recording movies (:29).

## Normal Speed Movie Options

Option (Image size/Frame rate <sup>1</sup> , File format)	Image size	Aspect ratio (horizontal to vertical)
 1080/30p  1080/25p (default setting)	1920 × 1080	16:9
 1080/60i  1080/50i	1920 × 1080	16:9
 720/30p  720/25p	1280 × 720	16:9
 iFrame 720/30p <sup>2</sup>  iFrame 720/25p <sup>2</sup>	1280 × 720	16:9
 480/30p  480/25p	640 × 480	4:3





<sup>1</sup> The items and frame rate that can be set vary depending on the **Frame rate** setting in the movie menu (:62).

<sup>2</sup> iFrame is a format supported by Apple Inc. When recording movies to the internal memory, recording may stop before the maximum movie length is reached.

## HS Movie Options

Recorded movies are played back in fast or slow motion.

See “Recording Movies in Slow Motion and Fast Motion (HS Movie)” (📷57).



Option	Image size Aspect ratio (horizontal to vertical)	Description
 HS 240/8x	320 × 240 4:3	1/8-speed slow motion movies • Max. recording time*: 10 seconds (playback time: 1 minute 20 seconds)
 HS 480/4x	640 × 480 4:3	1/4-speed slow motion movies • Max. recording time*: 15 seconds (playback time: 1 minute)
 HS 720/2x	1280 × 720 16:9	1/2-speed slow motion movies • Max. recording time*: 30 seconds (playback time: 1 minute)
 HS 1080/0.5x	1920 × 1080 16:9	2x speed fast motion movies • Max. recording time*: 2 minutes (playback time: 1 minute)

- \* While recording movies, the camera can be switched between normal speed movie recording and slow motion or fast motion movie recording. The maximum recording time shown here refers only to the portion of the movie that is recorded in slow motion or fast motion.



### Notes About HS Movie

- Sound is not recorded.
- Zoom position, focus, exposure, and white balance are locked when movie recording starts.

## Recording Movies in Slow Motion and Fast Motion (HS Movie)

Enter shooting mode → MENU button →  menu icon → Movie options →  button



Movies recorded using HS movie can be played back in slow motion at 1/8, 1/4 or 1/2 of the normal playback speed, or in fast motion at twice the normal playback speed.

**1** Use the multi selector  to select an HS movie option () and press the  button.

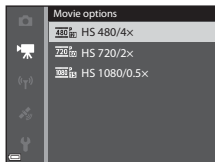
- After applying the option, press the **MENU** button to return to the shooting screen.



**2** Press the  (movie-record) button to start recording.

- Movie recording starts at high speed when the **Open with HS footage** option in the movie menu is set to **On**, or at normal speed when it is set to **Off**.
- The camera switches between normal speed movie recording and HS movie recording each time the  button is pressed.
- The movie options icon changes when switching between HS movie recording and normal speed movie recording.
- When the maximum recording time for HS movies () is reached, the camera automatically switches to normal speed movie recording.

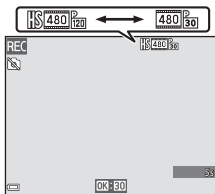

**3** Press the  (movie-record) button to end recording.

## **Playing Back in Slow Motion and Fast Motion**

**When recording at normal speed:**

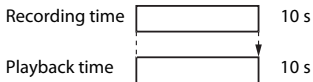

**When recording at  $\frac{480}{120}$  P HS 480/4x ( $\frac{480}{120}$  P HS 480/4x):**

Movies are recorded at 4x normal speed.

They are played back in slow motion at 4x slower speed.

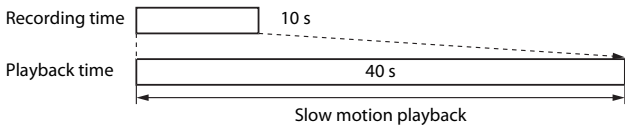

**When recording at  $\frac{1080}{120}$  P HS 1080/0.5x ( $\frac{1080}{120}$  P HS 1080/0.5x):**

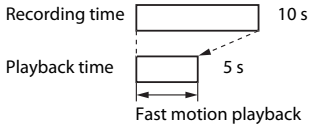

Movies are recorded at 1/2 normal speed.

They are played back in fast motion at 2x faster speed.







## Open with HS Footage

Enter shooting mode → MENU button →  menu icon → Open with HS footage →  button

Set whether to start recording HS movies or at normal speed when recording HS movies.

Option	Description
On (default setting)	Record HS movies when movie recording begins.
Off	Record normal speed movies when movie recording begins.

## AF Area Mode





Enter shooting mode → MENU button →  menu icon → AF area mode →  button

Use this option to determine how the camera selects the focus area for autofocus during movie recording.



Option	Description
 Face priority (default setting)	When the camera detects a human face, it focuses on that face. See “Using Face Detection” (📖69) for more information.
[ ■ ] Center	The camera focuses on the subject in the center of the frame.

### Notes About AF Area Mode for Movie Recording

**AF area mode** is set to focus on the center in the following situations even when **Face priority** is selected.

- When **Movie VR** is set to **On (hybrid)** and **Movie options** is set to  **1080/60i** or  **1080/50i**.
- When **Autofocus mode** in the movie menu is set to **Single AF** and no faces are detected before pressing the  ( movie-record) button.
- When an HS movie option is selected in **Movie options**.

## Autofocus Mode



Enter shooting mode → MENU button →  menu icon → Autofocus mode →  button

Set how the camera focuses in movie mode.

Option	Description
<b>AF-S</b> Single AF (default setting)	Focus is locked when the  (movie-record) button is pressed to start recording. Select this option when the distance between the camera and the subject will remain fairly consistent.
<b>AF-F</b> Full-time AF	Camera focuses continuously. Select this option when the distance between the camera and subject will change significantly during recording. The sound of the camera focusing may be heard in the recorded movie. Use of <b>Single AF</b> is recommended to prevent the sound of the camera focusing from interfering with recording.



- When an HS movie option is selected in **Movie options**, the setting is fixed at **Single AF**.

## Movie VR

Enter shooting mode → MENU button →  menu icon → Movie VR → 

Set to reduce the effects of camera shake while recording movies.



Set this option to **Off** when using a tripod to stabilize the camera during recording.

Option	Description
 * On (hybrid) (default setting)	Performs optical compensation for camera shake using the lens shift method. Also performs electronic VR using image processing. The angle of view (i.e., the area visible in the frame) becomes narrower.
 On	Compensates for camera shake using the lens shift method.
Off	Compensation is not performed.

### **Notes About Movie VR**

The effects of camera shake may not be completely eliminated in some situations.

## Wind Noise Reduction



Enter shooting mode → MENU button →  menu icon → Wind noise reduction →  button

Set whether or not to reduce wind noise during movie recording.

Option	Description
 On	Reduces the sound produced when wind passes over the microphones. Other sounds may become difficult to hear during playback.
Off (default setting)	Wind noise reduction is not enabled.

- When an HS movie option is selected in **Movie options**, the setting is fixed at **Off**.

## Frame Rate

Enter shooting mode → MENU button →  menu icon → Frame rate →  button

Select the frame rate used when recording movies.

When the frame rate is switched, available frame rates in **Movie options** (55) are changed.



- **30 fps (30p/60i)** is suitable for a TV using the NTSC system to play back movies, and **25 fps (25p/50i)** for a TV using the PAL system.

# The Setup Menu

## Welcome Screen

Press the **MENU** button →  menu icon → Welcome screen →  button

Configure the welcome screen that is displayed when you turn on the camera.

Option	Description
None (default setting)	Does not display the welcome screen.
COOLPIX	Displays a welcome screen with the COOLPIX logo.
Select an image	Displays an image selected for the welcome screen. <ul style="list-style-type: none"><li>• The image selection screen is displayed. Select an image () and press the  button.</li><li>• Because a copy of the selected image is saved in the camera, it will be displayed when the camera is turned on, even if the original image is deleted.</li><li>• Images captured using easy panorama cannot be selected.</li><li>• An image cannot be selected if the image size is extremely small after the small picture or crop function is applied.</li></ul>

## Time Zone and Date

Press the **MENU** button → **Y** menu icon → Time zone and date → **OK** button

Set the camera clock.

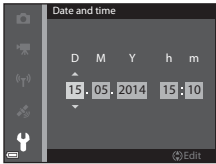
Option	Description
Date and time	<ul style="list-style-type: none"><li>• Select an item: Press the multi selector ◀▶ (changes between <b>D</b>, <b>M</b>, <b>Y</b>, <b>h</b>, and <b>m</b>).</li><li>• Edit the date and time: Press ▲▼. Date and time can also be changed by rotating the multi selector.</li><li>• Apply the setting: Select the <b>m</b> setting and press the <b>OK</b> button.</li></ul> 
Date format	Select <b>Year/Month/Day</b> , <b>Month/Day/Year</b> , or <b>Day/Month/Year</b> .
Time zone	Set time zone and daylight saving time. <ul style="list-style-type: none"><li>• When <b>Travel destination</b> (📍) is set after having set the home time zone (🏠), the time difference between the travel destination and the home time zone is automatically calculated, and the date and time are saved for the selected region.</li></ul>

## Setting the Time Zone

- 1 Use the multi selector ▲▼ to select **Time zone** and press the **OK** button.

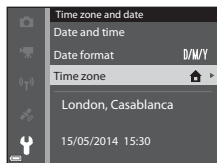

- 2 Select **Home time zone** or **Travel destination** and press the **OK** button.

- The date and time displayed in the monitor changes depending on whether the home time zone or travel destination is selected.

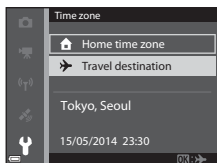

- 3 Press **▶**.

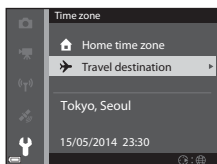

- 4 Use **◀▶** to select the time zone.

- Press ▲ to enable daylight saving time function, and ☀ is displayed. Press ▼ to disable the daylight saving time function.
- Press the **OK** button to apply the time zone.
- If the correct time is not displayed for the home or travel destination time zone setting, set the appropriate time in **Date and time**.

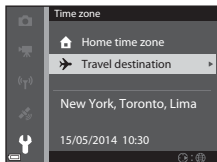
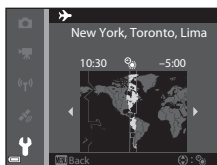

# Monitor Settings





Press the **MENU** button → **Y** menu icon → Monitor settings → **OK** button

Option	Description
Photo info	Set whether or not to display information in the monitor.
Image review	This setting determines whether or not the captured image is displayed immediately after shooting. <ul style="list-style-type: none"><li>• Default setting: <b>On</b></li></ul>
Brightness	Select from 5 settings. <ul style="list-style-type: none"><li>• Default setting: <b>3</b></li></ul>



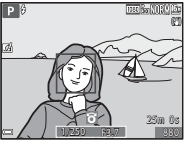

## ✓ Notes About Monitor Settings

When **Quick effects** (📷41) is set to **On**, the captured image is displayed after each shot regardless of the **Image review** setting.

## Photo Info

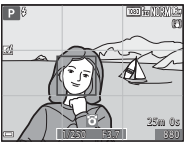
	Shooting mode	Playback mode
Show info		
Auto info (default setting)	Current settings and operation guide are displayed as in <b>Show info</b> . If no operations are performed for a few seconds, the information is hidden as in <b>Hide info</b> . Information is displayed again when the next operation is performed.	
Hide info		

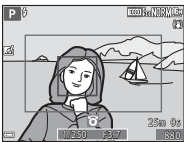

	Shooting mode	Playback mode
<p><b>Framing grid+auto info</b></p>	 <p>In addition to information shown with <b>Auto info</b>, a framing grid is displayed to help frame images. The framing grid is not displayed when recording movies.</p>	 <p>The current settings or operation guide is displayed as in <b>Auto info</b>.</p>
<p><b>Movie frame+auto info</b></p>	 <p>In addition to information shown with <b>Auto info</b>, a frame is displayed before recording begins that represents the area that will be captured when recording movies. The movie frame is not displayed when recording movies.</p>	 <p>The current settings or operation guide is displayed as in <b>Auto info</b>.</p>

## Print Date (Imprinting Date and Time)

Press the **MENU** button → **Y** menu icon → Print date → **OK** button

The shooting date and time can be imprinted on the images when shooting, allowing the information to be printed even from printers that do not support date printing (📷47).



Option	Description
<b>DATE</b> Date	Date is imprinted on images.
<b>DATE</b> 🕒 Date and time	Date and time are imprinted on images.
Off (default setting)	Date and time are not imprinted on images.



### ✓ Notes About Print Date

- Imprinted dates form a permanent part of image data and cannot be deleted. The date and time cannot be imprinted on images after they have been captured.
- The date and time cannot be imprinted in the following situations:
  - When the scene mode is set to **Sports**, **Night portrait** (when set to **Hand-held**), **Night landscape** (when set to **Hand-held**), **Museum**, **Backlighting** (when **HDR** is **On**), **Easy panorama** or **Pet portrait** (when set to **Continuous**)
  - When **Blink proof** is set to **On** or when **Smile timer** is set to **On (continuous)** or **On (BSS)** in smart portrait mode
  - When **Continuous H**, **Continuous L**, **Pre-shooting cache**, **Continuous H: 120 fps**, **Continuous H: 60 fps** or **BSS** is selected for **Continuous** (📷34)
  - When recording movies
  - When saving still images during movie recording
- The imprinted date and time may be difficult to read when using a small image size.

## Photo VR

Press the **MENU** button →  menu icon → Photo VR →  button

Set to reduce the effects of camera shake while shooting still images. Set this option to **Off** when using a tripod to stabilize the camera during shooting.

Option	Description
 * On (hybrid)	Performs optical compensation for camera shake using the lens shift method. Under the following conditions, also performs electronic VR using image processing. <ul style="list-style-type: none"><li>• Flash: Does not fire</li><li>• Shutter speed: Slower than 1/30 second at the maximum wide-angle position and 1/250 second at the maximum telephoto position</li><li>• Self-timer: <b>OFF</b></li><li>• <b>Continuous</b> setting: <b>Single</b></li><li>• ISO sensitivity: ISO 200 or lower</li></ul> The image recording time may be longer than usual.
 On (default setting)	Compensates for camera shake using the lens shift method.
Off	Compensation is not performed.





### Notes About Photo VR

- After turning on the camera or after switching from playback mode to shooting mode, wait for the shooting screen to be displayed completely before taking images.
- Images displayed on the shooting screen immediately after shooting may be displayed blurry.
- The effects of camera shake may not be completely eliminated in some situations.
- When the shutter speed is extremely slow, images cannot be compensated using image processing even when **On (hybrid)** is set.

## Motion Detection

Press the **MENU** button →  menu icon → Motion detection →  button



Enable motion detection to reduce the effects of subject movement and camera shake when shooting still images.

Option	Description
 Auto (default setting)	Motion detection is enabled with some shooting modes or settings, when  is displayed on the shooting screen. When the camera detects subject movement or camera shake,  turns green, and the ISO sensitivity and shutter speed are automatically increased to reduce blurring. <ul style="list-style-type: none"><li>• Set <b>ISO sensitivity</b> () to <b>Auto</b> in <b>P, S, A,</b> or <b>M</b> mode.</li></ul>
Off	Motion detection is disabled.

### Notes About Motion Detection

- Motion detection may be unable to eliminate the effects of subject movement and camera shake in some situations.
- Motion detection may be disabled if the subject exhibits significant movement or is too dark.
- The images captured using motion detection may be somewhat “grainy” in appearance.

## AF Assist





Press the **MENU** button →  menu icon → AF assist →  button

Enable or disable the AF-assist illuminator which assists autofocus operation.



Option	Description
<b>AUTO</b> Auto (default setting)	The AF-assist illuminator automatically lights up when the subject is dimly lit. The illuminator has a range of about 5.0 m (16 ft) at the maximum wide-angle position and about 4.5 m (14 ft) at the maximum telephoto position. <ul style="list-style-type: none"><li>• Note that for some scene modes or focus areas, the AF-assist illuminator may not light.</li></ul>
Off	The AF-assist illuminator does not light.

## Digital Zoom

Press the **MENU** button →  menu icon → Digital zoom →  button

Option	Description
On (default setting)	Digital zoom is enabled.
 Crop	The zoom ratio is limited within a range in which the image quality does not deteriorate (L25). <ul style="list-style-type: none"><li>• Digital zoom is not available when the image size is  <b>4608×3456</b>,  <b>4608×2592</b>, or  <b>3456×3456</b>.</li><li>• This setting functions in the same way as the <b>On</b> setting during movie recording.</li></ul>
Off	Digital zoom is disabled.

### Notes About Digital Zoom



- Digital zoom cannot be used in the following situations.
  - When the scene mode is set to **Scene auto selector**, **Portrait**, **Night portrait**, **Night landscape**, **Backlighting** (when **HDR** is **On**), **Easy panorama** or **Pet portrait**
  - When smart portrait mode is selected
  - When **Continuous** () is set to **Multi-shot 16** in **P**, **S**, **A**, or **M** mode
  - When **AF area mode** () is set to **Subject tracking** in **P**, **S**, **A**, or **M** mode
- When digital zoom is in effect, **Metering** () is set to **Center-weighted** or spot metering (where the center of the frame is metered) depending on the magnification of an enlargement.

## Sound Settings

Press the MENU button →  menu icon → Sound settings →  button

Option	Description
Button sound	When <b>On</b> (default setting) is selected, the camera produces one beep when operations are performed, two beeps when focus is acquired on the subject, and three beeps when an error occurs. The start-up sound is also produced. <ul style="list-style-type: none"><li>• Sounds are disabled when using <b>Pet portrait</b> scene mode.</li></ul>
Shutter sound	When <b>On</b> (default setting) is selected, the shutter sound is produced when the shutter is released. <ul style="list-style-type: none"><li>• The shutter sound is not produced when using continuous shooting mode, when recording movies, or when using <b>Pet portrait</b> scene mode.</li></ul>

## Auto Off

Press the MENU button →  menu icon → Auto off →  button

Set the amount of time that elapses before the camera enters standby mode (21).

You can select **30 s**, **1 min** (default setting), **5 min**, or **30 min**.

### Notes About Auto Off

The time that passes before the camera enters standby mode is fixed in the following situations:

- When shooting with **Pet portrait auto release**: 5 minutes (if **Auto off** is set to **30 s** or **1 min**)
- When shooting with **Smile timer**: 5 minutes (if **Auto off** is set to **30 s** or **1 min**)
- When a menu is displayed: 3 minutes (if **Auto off** is set to **30 s** or **1 min**)
- When the AC adapter is connected: 30 minutes

## Format Memory/Format Card

Press the MENU button → Y menu icon → Format memory/Format card → OK button

Use this option to format the internal memory or a memory card.

**Formatting the internal memory or memory cards permanently deletes all data. Data that has been deleted cannot be recovered.** Make sure to transfer important images to a computer before formatting.

- Do not turn the camera off or open the battery-chamber/memory card slot cover during formatting.

### Formatting the Internal Memory

Remove the memory card from the camera. The

**Format memory** option is displayed in the setup menu.

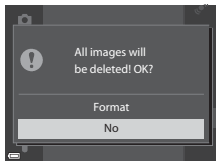



### Formatting Memory Cards

Insert a memory card in the camera. The

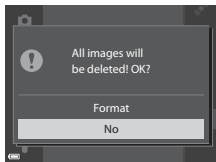
**Format card** option is displayed in the setup menu.





## Language

Press the **MENU** button →  menu icon → Language →  button

Select a language for display of camera menus and messages.

## TV Settings

Press the **MENU** button →  menu icon → TV settings →  button

Adjust settings for connection to a TV.

Option	Description
HDMI	Select a resolution for HDMI output. When <b>Auto</b> (default setting) is selected, the option best suited to the TV to which the camera is connected is automatically selected from <b>480p</b> , <b>720p</b> , or <b>1080i</b> .
HDMI device control	When <b>On</b> (default setting) is selected, the HDMI-CEC-compatible TV's remote control can be used to control the camera during playback (  20).





### HDMI and HDMI-CEC

HDMI (High-Definition Multimedia Interface) is a multimedia interface. HDMI-CEC (HDMI-Consumer Electronics Control) allows compatible devices to inter-operate.



## Charge by Computer

Press the **MENU** button →  menu icon → Charge by computer →  button

Option	Description
<b>AUTO</b> Auto (default setting)	When the camera is connected to a computer that is running (  96), the battery inserted into the camera is automatically charged using power supplied by the computer.
Off	The battery inserted into the camera is not charged when the camera is connected to a computer.

### **Notes About Charging with a Computer**

- When connected to a computer, the camera automatically turns on and starts charging. If the camera is turned off, charging stops.
- About 4 hours and 10 minutes are required to charge a fully exhausted battery. Charging time increases when images are transferred while the battery is charging.
- The camera turns off automatically if there is no communication with the computer for 30 minutes after the battery has finished charging.

### **When the Charge Lamp Quickly Flashes Green**

Charging cannot be performed, possibly due to one of the reasons described below.

- The ambient temperature is not suited to charging. Charge the battery indoors with an ambient temperature of 5°C to 35°C (41°F to 95°F).
- The USB cable is not connected correctly, or the battery is faulty. Make sure the USB cable is connected correctly and replace the battery if necessary.
- The computer is in sleep mode and is not supplying power. Wake up the computer.
- The battery cannot be charged because the computer cannot supply power to the camera due to the computer's settings or its specifications.

## Blink Warning

Press the **MENU** button → **Y** menu icon → **Blink warning** → **OK** button

Select whether or not the camera detects human subjects that have blinked using face detection (📖69) when shooting in the following modes:

- In the following scene modes: **Scene auto selector** (📖33), **Portrait**, **Night portrait** (when **Tripod** is selected) (📖34)
- **P**, **S**, **A**, or **M** mode (when **Face priority** (📖38) is selected for AF area mode option)

Option	Description
On	When one or more human subjects may have blinked in an image captured using face detection, the <b>Did someone blink?</b> screen is displayed in the monitor. Check the image and determine whether or not another image should be captured.
Off (default setting)	Blink warning is disabled.

### The Blink Warning Screen

Faces detected by the blink warning are displayed inside a border.

The operations described below are available.

- To enlarge the face: Move the zoom control toward **T** (📖). If more than one face is detected, use the multi selector ◀▶ to select the desired face.
- To switch to full-frame playback: Move the zoom control toward **W** (📖).

If you press the **OK** button, or if no operations are performed for a few seconds, the camera returns to shooting mode.

#### ✓ Notes About Blink Warning

- The blink warning is disabled at continuous settings other than **Single** (📖34).
- The blink warning may not function properly in some shooting conditions.



# Eye-Fi Upload

Press the **MENU** button →  menu icon → Eye-Fi upload →  button





Option	Description
 <b>Enable</b> (default setting)	Upload images created by the camera to a preselected destination.
 <b>Disable</b>	Images are not uploaded.

## **Notes About Eye-Fi Cards**

- Note that images will not be uploaded if signal strength is insufficient even if **Enable** is selected.
- Remove your Eye-Fi card from the camera where wireless devices are prohibited. Signals may be transmitted even if **Disable** is selected.
- Refer to the instruction manual of your Eye-Fi card for more information. In the event of malfunction, contact the card manufacturer.
- The camera can be used to turn Eye-Fi cards on and off, but may not support other Eye-Fi functions.
- The camera is not compatible with the Endless Memory function. When it is set on a computer, disable the function. If the Endless Memory function is enabled, the number of images taken may not be displayed correctly.
- Eye-Fi cards are for use only in the country of purchase. Observe all local laws concerning wireless devices.
- Leaving the setting as **Enable** will result in the battery being depleted in a shorter period of time.

## **Eye-Fi Communication Indicator**

The communication status of the Eye-Fi card in the camera can be confirmed in the monitor (7).

- : **Eye-Fi upload** is set to **Disable**.
-  (lights): Eye-Fi upload enabled; waiting to begin upload.
-  (flashes): Eye-Fi upload enabled; uploading data.
- : Eye-Fi upload enabled but no images available for upload.
- : An error occurred. The camera cannot control the Eye-Fi card.

## Reset All

Press the MENU button →  menu icon → Reset all →  button

When **Reset** is selected, the camera's settings are restored to their default values.

- Some settings, such as **Time zone and date** or **Language**, are not reset.



### Resetting File Numbering

To reset file numbering to "0001", delete all images saved in the internal memory or on the memory card ( 29) before selecting **Reset all**.

---



## Firmware Version

Press the MENU button →  menu icon → Firmware version →  button

View the current camera firmware version.

# The Location Data Options Menu

## Location Data Options

Press the **MENU** button →  (location data options) menu icon → Location data options →  button

Option	Description
Record location data	When set to <b>On</b> , signals are received from the positioning satellites, and positioning starts (85). <ul style="list-style-type: none"><li>• Default setting: <b>Off</b></li></ul>
Update A-GPS file	A memory card is used to update the A-GPS (assist GPS) file. Using the latest A-GPS file can shorten the time needed for obtaining the location data. <ul style="list-style-type: none"><li>• See "Updating the A-GPS File" (879) for more information.</li></ul>
Erase location data	The location data and POI information recorded on images are erased. <ul style="list-style-type: none"><li>• The deleted location data or POI information cannot be recovered.</li><li>• The location data of images captured with cameras other than this camera cannot be erased.</li></ul>

## Updating the A-GPS File

Download the latest A-GPS file from the website below, and use it to update the file.

<http://nikonimglib.com/agps3/>

- The A-GPS file for the COOLPIX S9700 is only available from the website above.
- To update the A-GPS file, set **Record location data** to **Off**. When **On** is selected, the A-GPS file cannot be updated.



- 1** Download the latest A-GPS file to the computer from the website.
- 2** Use a card reader or other device to copy the downloaded file to the "NCFL" folder of the memory card.
  - The "NCFL" folder is located directly under the memory card root directory. If the memory card does not have "NCFL" folder, create a new folder.

- 
- 3 Insert the memory card containing the copied file into the camera.
  - 4 Turn on the camera.
  - 5 Press the **MENU** button to display the Location data options menu, and use the multi selector to select **Location data options**.
  - 6 Select **Update A-GPS file**, and update the file.
    - About 2 minutes are needed to update the A-GPS file.
- 

 **Notes About Updating A-GPS File**





- The A-GPS file is disabled when a position is determined for the first time after the camera is purchased. The A-GPS file becomes active from the second operation for determining a location.
  - The validity period of the A-GPS file can be checked on the update screen. If the validity period has expired, it is displayed in gray.
  - Once the validity period of the A-GPS file has expired, obtaining the location data will not become faster. Updating of the A-GPS file before using the location data functions is recommended.
- 

## Distance Units



Press the **MENU** button →  (location data options) menu icon → Distance units →  button

The distance units of the map display can be selected from **km (m)** (kilometers, meters) (default setting) or **mi (yd)** (miles, yards).

# Calculate Distance



Press the  button (playback mode) → Display a map (88) → MENU button →  (location data options) menu icon → Calculate distance →  button

Calculate the linear distance from the current position to the shooting location of the image or between the shooting locations of two images.

**1** Use the multi selector   to select the desired option for calculating the distance, and press the  button.

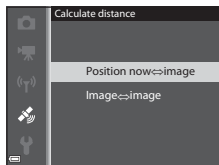

- **Position now ↔ image**: Calculates the distance from the current position to the image shooting location. Confirmation of the current position starts. Proceed to step 3.
- **Image ↔ image**: Calculates the distance between the shooting locations of two images.



**2** Use   to select the image that is the start point, and press the  button.

- To adjust the scale of the map, use the zoom control ( /T ).



**3** Press   to select the image that is the end point.

- Each time an image is selected, the distance is displayed on the screen.
- To end distance calculation, press the  button.





Distance



## Notes About Distance Calculation

- If the location data is not recorded on the image, the distance cannot be calculated.
- In order to calculate the distance using **Position now ↔ image**, the current position must have been obtained (85).

## Points of Interest (POI) (Recording and Displaying Location Name Information)

Press the **MENU** button →  (location data options) menu icon → Points of interest (POI) →  button

Configure the POI (points of interest, location name information) settings.

Option	Description
Embed POI	Set whether or not to record the location name information on the images to be shot. <ul style="list-style-type: none"><li>• Default setting: <b>Off</b></li><li>• The location name information can be recorded on both still images and movies.</li></ul>
Display POI	Set whether or not to display the location name information on the shooting screen or playback screen (  , 6, 8). If <b>Embed POI</b> was set to <b>On</b> when an image was taken, the location name information for the image is displayed on the playback screen. <ul style="list-style-type: none"><li>• Default setting: <b>Off</b></li></ul>
Level of detail	Set the display level of the location name information. A higher display level shows more detailed regional information. <ul style="list-style-type: none"><li>• When set to level 1: country names are displayed.</li><li>• When set to levels 2 to 5: the information displayed varies depending on the country.</li><li>• When set to level 6: landmark names (facilities) are displayed.</li></ul>
Edit POI	If <b>Update POI</b> is selected during playback mode, the location name information recorded on the image can be changed. Before pressing the <b>MENU</b> button, select the image to change the location name information. <ul style="list-style-type: none"><li>• When level 6 is selected, press the multi selector  to change the landmark name.</li><li>• To change the POI information level, press the multi selector .</li></ul> If <b>Remove POI</b> is selected, the location name information recorded on the image is deleted.



### POI Display

If there is no location name information at the set display level, no information may be displayed.



## Create Log (Record the Log of Movement Information)

Press the MENU button → 📍 (location data options) menu icon → Create log → Ⓞ button

When log recording starts, the measured movement information is recorded until a preset time has elapsed at the interval set for **Log interval**.

- The recorded log data cannot be used by itself. To use the data, end log recording and save it to a memory card.

**1** Use the multi selector ▲▼ to select **Start log**, and press the Ⓞ button.

- Before selecting **Start log**, select **Log interval** and press the Ⓞ button to select the intervals of log recording. The default setting is **15 s**.

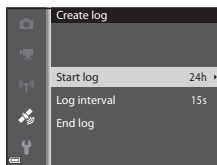

**2** Select the duration that the log will be recorded, and press the Ⓞ button.

- Log recording starts.
- The log data is recorded at the interval set for the **Log interval** until the preset time is reached.
- **LOG** is displayed on the screen during log recording (📖7).

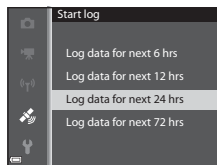

**3** When log recording is completed, select **End log** on the screen shown in step 1, and press the Ⓞ button.

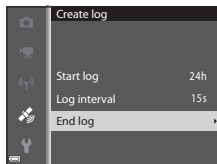

## 4 Select **Save log**, and press the **OK** button.

- The log data is saved to a memory card.

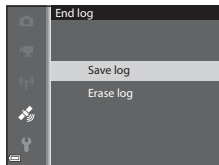

### **Notes About Log Recording**

- If the date and time are not set, the log cannot be recorded.
- Use a fully charged battery to prevent the camera from turning off during log recording. When the battery power becomes exhausted, log recording ends.
- Even when the camera is turned off, log recording is continuously performed until the preset time has elapsed if there is still time remaining for log recording.
- Log recording ends due to the operations below even when there is time remaining for log recording.
  - The battery is removed
  - **Record location data** in **Location data options** is set to **Off** when the location log is recorded
  - **Reset all** in the setup menu is performed
  - The setting of the internal clock (time zone or date and time) is changed
  - **End log** is selected in **Create log** (83) of the Location data options menu
- Log recording is paused during the operations below.
  - During continuous shooting
  - During movie recording
  - When connected with a USB cable or HDMI cable



Log recording is resumed when the above operations are finished. However, to resume log recording after using the charging AC adapter, you must turn on the camera after disconnecting the USB cable from it.

- The log data is temporarily stored in the camera. New logs cannot be recorded if the log data remains in the camera. After recording log data, save it to a memory card.
- See “Log Data Saved on Memory Cards” (96) for more information.

### **To Erase Log Data**



- To erase the log data that is temporarily stored in the camera, select **Erase log** in step 4.
- To erase the log data that is stored on the memory card, press the  button in **View log** (85).

# View Log

Press the **MENU** button →  (location data options) menu icon → View log →  button





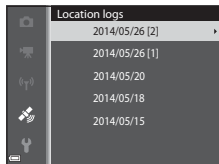

Check or erase the log data stored on the memory card using **Create log** (83).

## 1 Select the log data to be displayed, and press the button.

- See “Log Data Saved on Memory Cards” (96) for more information.
- See “To Erase Log Data” (86) for more information.



## 2 Check the movement route.

- Your movement route is displayed on the map.
- To adjust the scale of the map, use the zoom control (**W** /**T** .
- To move the map display, use the multi selector.
- To erase the displayed log data, press the  button.
- The following operations can be performed when you press the  button.
  - **Location logs:** The monitor display returns to that shown in step 1.
  - **Save location:** You can save the location by selecting the location on a map and pressing the  button.
  - **Center on saved location:** You can display the saved location in the center of the map by selecting it (90).

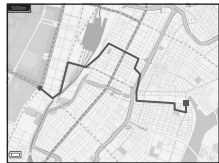

## To Erase Log Data

Press the  button in step 1 to select either function.



- **Selected log:** The selected log data is erased.
- **All logs:** All log data stored on the memory card is erased.

### Location Information Log Data

Log data is NMEA format-compliant. However, display in all NMEA format-compliant software or on all NMEA format-compliant cameras is not guaranteed.



---

## Set Clock from Satellite



Press the **MENU** button →  (location data options) menu icon → **Set clock from satellite** →  button

Signals from the positioning satellites are used to set the date and time of the camera's internal clock. Check the positioning status before setting the clock using this option.

### Notes About Set Clock from Satellite

- To set the camera's internal clock, positioning must have been done successfully (85).
- Date/time adjustment by **Set clock from satellite** is set according to the time zone set in **Time zone and date** (83, 64) of the setup menu. Check the time zone before setting **Set clock from satellite**.
- The date/time set using **Set clock from satellite** is not as accurate as radio clocks. Use **Time zone and date** in the setup menu to set the time if it is not accurate in **Set clock from satellite**.

# Electronic Compass

Press the **MENU** button →  (location data options) menu icon → Electronic compass →  button

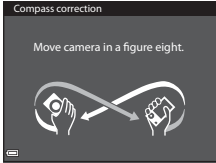
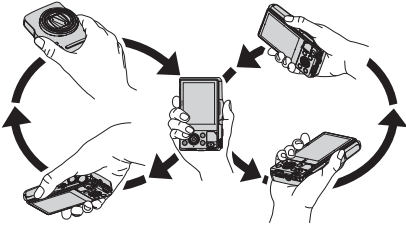
Option	Description
Compass display	<p>Set whether or not to display a compass on the shooting screen.</p> <ul style="list-style-type: none"><li>• Default setting: <b>Off</b></li><li>• The direction the camera is pointing is displayed based on measured direction information.</li><li>• When the camera lens faces downward, the compass display switches to a circle compass with a red arrow that points north.<ul style="list-style-type: none"><li>- Display style: north, east, south and west</li><li>- Display range: 16 cardinal points</li></ul></li></ul>
Compass correction	<p>Correct the compass when the compass direction is not displayed correctly. When the screen shown on the right is displayed, swing the camera to draw a figure eight in the air while turning your wrist to face the camera forward and backward, side to side, or up and down.</p>  



## **Notes About Using the Electronic Compass**

- The electronic compass is not displayed when the camera lens is facing upwards.
- Do not use the electronic compass in this camera for mountain climbing and other specialized applications. The displayed information is intended as a general guide only.
- Direction may not be measured correctly near the following objects:  
magnets, metals, electrical motors, electrical home appliances or electrical power cables.
- Direction may not be measured correctly in the following places:  
in automobiles, trains, ships, airplanes, inside buildings or in underground malls
- Direction may not be measured correctly if the location data is not obtained.

## The Wi-Fi Options Menu





Press the **MENU** button →  menu icon →  button

Configure the Wi-Fi (wireless LAN) settings to connect the camera and a smart device.

Option	Description
Connect to smart device	Select when wirelessly connecting the camera and a smart device. See "Using the Wi-Fi (Wireless LAN) Function" (  93) for more information.
Disable Wi-Fi	Select to terminate the wireless connection between the camera and a smart device. See "Using the Wi-Fi (Wireless LAN) Function" (  93) for more information.
Options	<b>SSID:</b> Change the SSID. The SSID configured here is displayed on the smart device. Set a 1- to 24-character alphanumeric SSID.
	<b>Auth./encryp.:</b> Select whether or not to encrypt the communications between the camera and the connected smart device. Communications are not encrypted when <b>Open</b> (default setting) is selected.
	<b>Password:</b> Set the password. Set an 8- to 16-character alphanumeric password.
	<b>Channel:</b> Select the channel used for wireless connections.
	<b>Subnet mask:</b> Use the default setting ( <b>255.255.255.0</b> ) under normal conditions.
	<b>DHCP server IP address:</b> Use the default setting ( <b>192.168.0.10</b> ) under normal conditions.
Current settings	Display the current settings.
Restore default settings	Restore the Wi-Fi settings to their default values.



## Operating the Text Input Keyboard

### Character Input for SSID and Password

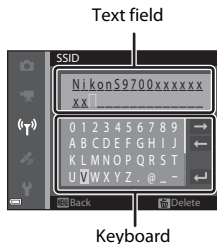
- Use the multi selector ▲▼◀▶ to select alphanumeric characters. Press the  button to enter the selected character in the text field and move the cursor to the next space.
- To move the cursor in the text field, select ← or → on the keyboard, and press the .
- To delete one character, press the  button.
- To apply the setting, select ↵ on the keyboard and press the .



### Character Input for Channel, Subnet mask and DHCP server IP address



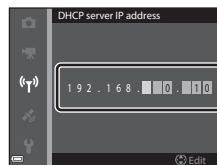

- Use the multi selector ▲▼ to set the numbers. To move to the next digit, press ▶ or the  button. To return to the previous digit, press ◀.
- To apply the setting, select the last digit and press the .





























## Error Messages









Refer to the table below if an error message is displayed.

Display	Cause/Solution	
Battery temperature is elevated. The camera will turn off.	The camera turns off automatically. Wait until the camera or battery temperature has cooled before resuming use.	-
The camera will turn off to prevent overheating.		
Memory card is write protected.	The write-protect switch is in the "lock" position. Slide the write-protect switch to the "write" position.	-
This card cannot be used.	An error occurred while accessing the memory card. <ul style="list-style-type: none"> <li>• Use an approved card.</li> <li>• Check that the terminals are clean.</li> <li>• Confirm that the memory card is correctly inserted.</li> </ul>	14,  29
This card cannot be read.		
Card is not formatted. Format card?	The memory card has not been formatted for use in the camera. Formatting deletes all data saved on the memory card. If you need to keep copies of any images, make sure to select <b>No</b> and save the copies to a computer or other medium before formatting the memory card. Select <b>Yes</b> and press the  button to format the memory card.	 5
Not available if Eye-Fi card is locked.	The write-protect switch of the Eye-Fi card is in the "lock" position.	-
	An error occurred while accessing the Eye-Fi card. <ul style="list-style-type: none"> <li>• Check that the terminals are clean.</li> <li>• Confirm that the Eye-Fi card is correctly inserted.</li> </ul>	14
Out of memory.	Delete images or insert a new memory card.	14, 29, 82

Display	Cause/Solution	
Image cannot be saved.	An error occurred while saving the image. Insert a new memory card or format the internal memory or memory card.	 73
	The camera has run out of file numbers. Insert a new memory card or format the internal memory or memory card.	 73
	The image cannot be used for the welcome screen.	 63
	There is insufficient space to save the copy. Delete images from the destination.	29
Album is full. No further pictures can be added.	200 images have already been added to the album. <ul style="list-style-type: none"> <li>Remove some images from the album.</li> <li>Add to other albums.</li> </ul>	 7  5
Sound file cannot be saved.	A voice memo cannot be attached to this image. <ul style="list-style-type: none"> <li>Voice memos cannot be attached to movies.</li> <li>Select an image captured with this camera.</li> </ul>	-
Image cannot be modified.	Select images that support the editing function.	 13,  15
Cannot record movie.	A time-out error occurred while saving the movie on the memory card. Select a memory card with a faster write speed.	77,  29
Memory contains no images.	There are no images in the internal memory or on the memory card. <ul style="list-style-type: none"> <li>Remove the memory card from the camera to play back images in the camera's internal memory.</li> <li>To copy the images saved in the camera's internal memory to the memory card, press the <b>MENU</b> button to select <b>Copy</b> in the playback menu.</li> </ul>	15   53
	No images have been added to the selected album.	 5,  6
	No images are contained in the category selected in auto sort mode.	 9
File contains no image data.	The file was not created or edited with this camera.	
This file cannot be played back.	The file cannot be viewed on this camera. View the file using a computer or the device used to create or edit this file.	-

Display	Cause/Solution	
All images are hidden.	There are no images available for a slide show, etc.	 49
This image cannot be deleted.	The image is protected. Disable protection.	 50
Failed to set clock from satellite.	The camera clock was not set correctly. Change the location or time and determine the location again.	-
No A-GPS file found on card.	An A-GPS file that can be updated is not found on the memory card. Check the following items. <ul style="list-style-type: none"> <li>• Whether the memory card is inserted</li> <li>• Whether the A-GPS file is stored on the memory card</li> <li>• Whether the A-GPS file saved on the memory card is more recent than the A-GPS file saved in the camera</li> <li>• Whether the A-GPS file is still valid</li> </ul>	-
Update failed.	Unable to update A-GPS file. The A-GPS file may be corrupted. Download the file from the website once more.	91,  79
Unable to determine current position.	Unable to determine the current position when distance is calculated. Change the location or time and determine the location again.	-
Cannot save to card.	A memory card is not inserted. Insert a memory card.	14
	The maximum number of log data events that can be saved per day is 36.	-
	The maximum number of log data events that can be saved in one memory card is 100. Replace the memory card with a new one or delete log data that is no longer required from a memory card.	 85
Unable to correct compass.	Unable to calibrate the electronic compass. Swing the camera to draw a figure eight in the air outdoors while turning your wrist to face the camera forward and backward, side to side, or up and down.	 87

Display	Cause/Solution	
No access.	The camera could not receive the communication signal from the smart device. Select <b>Connect to smart device</b> in the Wi-Fi options menu, and wirelessly connect the camera and smart device again.	94,  89
Could not connect.	The camera failed to establish the connection while receiving the communication signals from the smart device. Select a different channel in <b>Channel in Options</b> in the Wi-Fi options menu and establish the wireless connection again.	94,  89
Wi-Fi connection terminated.	A cable was connected to the camera while the camera and smart device were wirelessly connected, the battery level became low, or the connection was aborted due to poor connectivity. Check the status of the camera and establish the wireless connection again.	94,  89
Lens error	A lens error occurred. Turn the camera off and then on again. If the error persists, contact your retailer or Nikon-authorized service representative.	20
Communications error	An error occurred while communicating with the printer. Turn the camera off and reconnect the USB cable.	 22
System error	An error occurred in the camera's internal circuitry. Turn the camera off, remove and reinsert the battery, and turn the camera on. If the error persists, contact your retailer or Nikon-authorized service representative.	10, 20

Display	Cause/Solution	
Printer error: check printer status.	After solving the problem, select <b>Resume</b> and press the  button to resume printing.*	–
Printer error: check paper.	Load the specified size of paper, select <b>Resume</b> , and press the  button to resume printing.*	–
Printer error: paper jam.	Remove the jammed paper, select <b>Resume</b> , and press the  button to resume printing.*	–
Printer error: out of paper.	Load the specified size of paper, select <b>Resume</b> , and press the  button to resume printing.*	–
Printer error: check ink.	There is a problem with the printer's ink. Check the ink, select <b>Resume</b> , and press the  button to resume printing.*	–
Printer error: out of ink.	Replace the ink cartridge, select <b>Resume</b> , and press the  button to resume printing.*	–
Printer error: file corrupt.	There is a problem with the image file to be printed. Select <b>Cancel</b> and press the  button to cancel printing.	–

\* See the documentation provided with your printer for further guidance and information.

# File Names

Images, movies, or voice memos are assigned file names as follows.

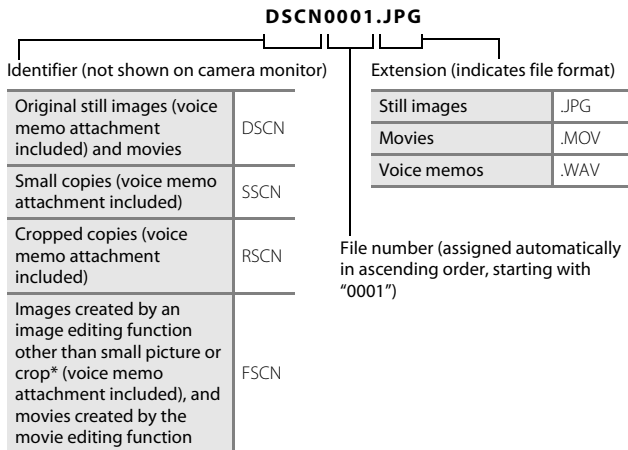

\* Including images edited using the quick effects function (📖44) in **P**, **S**, **A**, or **M** mode

- Voice memo file names have the same identifier and file number as the image to which the voice memo is attached.

## Log Data Saved on Memory Cards

The log data is saved in the "NCFL" folder.

- The file names consist of "N", "date (the last two digits of the year, month, and day in YYMMDD format)", "identification number (0 to 9 or A to Z)" and "extension (.log)".

Example: the first location data log recorded on 15 May 2014 is N1405150.log

- Up to 36 files can be recorded a day and up to 100 files can be recorded on a memory card.

## Optional Accessories

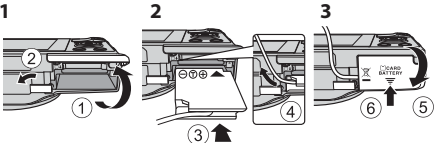
Battery charger	Battery Charger MH-65 (Charging time when no charge remains: Approx. 2 h 30 min)
AC adapter	<p data-bbox="332 253 715 278">AC Adapter EH-62F (connect as shown)</p>  <p data-bbox="332 492 912 627">Make sure that the power connector cord has been properly aligned in power connector and battery chamber grooves before closing the battery-chamber/memory card slot cover. If part of the cord runs out of the grooves, the cover or cord may be damaged when the cover is closed.</p>

Availability may vary with country or region.  
See our website or brochures for the latest information.



A series of horizontal dashed lines spanning the width of the page, intended for handwriting practice.





# Technical Notes and Index

<b>Caring for the Product</b> .....	2
The Camera.....	2
The Battery.....	3
Charging AC Adapter.....	4
Memory Cards.....	5
<b>Cleaning and Storage</b> .....	6
Cleaning.....	6
Storage.....	7
<b>Troubleshooting</b> .....	8
<b>USER LICENSE AGREEMENT FOR MAP DATA AND LOCATION NAME DATA</b> .....	19
<b>Specifications</b> .....	25
Approved Memory Cards.....	29
<b>Index</b> .....	32

# Caring for the Product

## The Camera

To ensure continued enjoyment of this Nikon product, observe the precautions described below in addition to the warnings in "For Your Safety" (vii-ix) when using or storing the device.

### **Do Not Drop**

The product may malfunction if subjected to strong shock or vibration.

### **Handle the Lens and All Moving Parts with Care**

Do not apply force to the lens, lens cover, monitor, memory card slot, or battery chamber. These parts are easily damaged. Applying force to the lens cover could result in camera malfunction or damage to the lens.

### **Keep Dry**

The device will be damaged if immersed in water or subjected to high humidity.

### **Avoid Sudden Changes in Temperature**

Sudden changes in temperature, such as when entering or leaving a heated building on a cold day, can cause condensation to form inside the device. To prevent condensation, place the device in a carrying case or a plastic bag before exposing it to sudden changes in temperature.

### **Keep away from Strong Magnetic Fields**

Do not use or store this device in the vicinity of equipment that generates strong electromagnetic radiation or magnetic fields. Strong static charge or the magnetic fields produced by equipment such as radio transmitters could interfere with the monitor, damage data saved on the memory card, or affect the product's internal circuitry.

### **Do Not Point the Lens at Strong Light Sources for Extended Periods**

Avoid pointing the lens at the sun or other strong light sources for extended periods when using or storing the camera. Intense light may cause deterioration of the image sensor, producing a white blur effect in photographs.

### **Turn the Product off Before Removing or Disconnecting the Power Source**

Do not remove the battery while the product is on, or while images are being saved or deleted. Forcibly cutting power in these circumstances could result in loss of data or in damage to product memory or internal circuitry.

## Notes About the Monitor

- Monitors and electronic viewfinders are constructed with extremely high precision; at least 99.99% of pixels are effective, with no more than 0.01% being missing or defective. Hence while these displays may contain pixels that are always lit (white, red, blue, or green) or always off (black), this is not a malfunction and has no effect on images recorded with the device.
- Due to the general characteristics of OLED monitors, prolonged or repeated display of the same screen or image may result in screen burn. Screen burn can be recognized by decreased brightness in portions of the monitor or mottled display. In some cases, screen burn may become permanent. However, images are in no way affected by screen burn.  
To prevent screen burn, do not set monitor brightness higher than necessary and do not display the same screen or image for an extended period of time.
- Images in the monitor may be difficult to see under bright lighting.
- The monitor is lit by an LED backlight. Should the monitor begin to dim or flicker, contact your Nikon-authorized service representative.

## The Battery

Be sure to read and follow the warnings in “For Your Safety” (📖vii-ix) before use.

- Check the battery level before using the camera and replace or charge the battery if necessary. Do not continue charging once the battery is fully charged as this will result in reduced battery performance. Whenever possible, carry a fully charged spare battery when taking images on important occasions.
- Do not use the battery at ambient temperatures below 0°C (32°F) or above 40°C (104°F).
- Charge the battery indoors with an ambient temperature of 5°C to 35°C (41°F to 95°F) before use.
- When charging the battery inserted into this camera using the charging AC adapter or a computer, the battery is not charged at battery temperatures below 0°C (32°F) or above 45°C (113°F).
- Note that the battery may become hot during use; wait for the battery to cool before charging. Failure to observe these precautions could damage the battery, impair its performance, or prevent it from charging normally.
- On cold days, the capacity of batteries tends to decrease. If an exhausted battery is used at a low temperature, the camera will not turn on. Be sure that the battery is fully charged before heading outside to take images in cold weather. Keep spare batteries in a warm place and exchange as necessary. Once warmed, a cold battery may recover some of its charge.
- Dirt on the battery terminals can prevent the camera from functioning. Should the battery terminals become dirty, wipe them off with a clean, dry cloth before use.

- If the battery will not be used for some time, insert it in the camera and completely exhaust it before removing it for storage. The battery should be stored in a cool location with an ambient temperature of 15°C to 25°C (59°F to 77°F). Do not store the battery in hot or extremely cold locations.
- Always remove the battery from the camera or optional battery charger when it is not being used. When inserted, minute amounts of current are drawn from the battery even when not in use. This may result in excessive draining of the battery and complete loss of function. Turning the camera on or off while the battery is exhausted can result in reduced battery life.
- Recharge the battery at least once every six months and completely exhaust it before returning it to storage.
- After removing the battery from the camera or optional battery charger, put the battery in a plastic bag, etc. to insulate the terminal and store it in a cool place.
- A marked drop in the time a fully-charged battery retains its charge, when used at room temperature, indicates that the battery needs to be replaced. Purchase a new EN-EL12 battery.
- Replace the battery when it no longer holds a charge. Used batteries are a valuable resource. Please recycle used batteries in accordance with local regulations.

## Charging AC Adapter

Be sure to read and follow the warnings in “For Your Safety” (📖vii-ix) before use.

- The Charging AC Adapter EH-71P is for use only with compatible devices. Do not use with another make or model of device.
- Do not use a USB cable other than the UC-E21. Using a USB cable other than the UC-E21 could result in overheating, fire or electric shock.
- Do not, under any circumstances, use another make or model of AC adapter other than Charging AC Adapter EH-71P, and do not use a commercially available USB-AC adapter or a battery charger for a mobile phone. Failure to observe this precaution could result in overheating or in damage to the camera.
- The EH-71P is compatible with AC 100-240 V, 50/60 Hz electrical outlets. When using in other countries, use a plug adapter (available commercially) as necessary. For more information about plug adapters, consult your travel agency.

## Memory Cards

- Use only Secure Digital memory cards. See “Approved Memory Cards” (p. 29) for recommended memory cards.
- Observe the precautions noted in the documentation included with your memory card.
- Do not affix labels or stickers to the memory card.
- Do not format the memory card using a computer.
- The first time you insert a memory card that has been used in another device into this camera, be sure to format it with this camera. We recommend formatting new memory cards with this camera before using them with this camera.
- Note that **formatting a memory card permanently deletes all images and other data on the memory card**. If there is data saved on the memory card that you wish to keep, copy that data to a computer before formatting.
- If the message **Card is not formatted. Format card?** is displayed when the camera is turned on, the memory card must be formatted. If there is data on the memory card that you do not want to delete, select **No** and press the **OK** button. Copy that data to a computer before formatting. To format the memory card, select **Yes**.
- Observe the following precautions while formatting the memory card, saving and deleting images, and copying images to a computer, otherwise data or the memory card itself may be damaged.
  - Do not open the battery-chamber/memory card slot cover or remove the memory card or battery.
  - Do not turn off the camera.
  - Do not disconnect the AC adapter.

# Cleaning and Storage

## Cleaning

Do not use alcohol, thinner, or other volatile chemicals.

Lens	Avoid touching glass parts with your fingers. Remove dust or lint with a blower (typically a small device with a rubber bulb attached to one end that is pumped to produce a stream of air out the other end). To remove fingerprints or other stains that cannot be removed with a blower, wipe the lens with a soft cloth, using a spiral motion that starts at the center of them and working toward the edges. If this fails, clean the lens using a cloth lightly dampened with commercial lens cleaner.
Monitor	Remove dust or lint with a blower. To remove fingerprints and other stains, clean the monitor with a soft, dry cloth, being careful not to apply pressure.
Body	Use a blower to remove dust, dirt, or sand, then wipe gently with a soft, dry cloth. After using the camera at the beach or other sandy or dusty environment, wipe off any sand, dust, or salt with a dry cloth lightly dampened with fresh water and dry thoroughly. <b>Note that foreign matter inside the camera could cause damage not covered by the warranty.</b>

## Storage

Turn the camera off when not in use. Be sure that the power-on lamp is off before putting the camera away. Remove the battery if the camera will not be used for an extended period. Do not store the camera with naphtha or camphor moth balls, or in any of the following locations:

- Next to equipment that produces strong electromagnetic fields, such as televisions or radios
- Exposed to temperatures below  $-10^{\circ}\text{C}$  ( $14^{\circ}\text{F}$ ) or above  $50^{\circ}\text{C}$  ( $122^{\circ}\text{F}$ )
- Places that are poorly ventilated or subject to humidity of over 60%



To prevent mold or mildew, take the camera out of storage at least once a month. Turn the camera on and release the shutter a few times before putting the camera away again.

For storing the battery, follow the precautions in "The Battery" (🔋:3) in "Caring for the Product" (🔧:2).











# Troubleshooting





If the camera fails to function as expected, check the list of common problems below before consulting your retailer or Nikon-authorized service representative.

## Power, Display, Settings Issues









Problem	Cause/Solution	
The camera is on but does not respond.	<ul style="list-style-type: none"><li>• Wait for recording to end.</li><li>• If the problem persists, turn the camera off. If the camera does not turn off, remove and reinsert the battery or batteries or, if you are using an AC adapter, disconnect and reconnect the AC adapter. Note that although any data currently being recorded will be lost, data that have already been recorded will not be affected by removing or disconnecting the power source.</li></ul>	– 20,  97
Battery inserted in the camera cannot be charged.	<ul style="list-style-type: none"><li>• Confirm all connections.</li><li>• When connected to a computer, the camera may not charge for any of the reasons described below.<ul style="list-style-type: none"><li>- <b>Off</b> is selected for <b>Charge by computer</b> in the setup menu.</li><li>- Battery charging stops if the camera is turned off.</li><li>- Battery charging is not possible if the camera's display language and date and time have not been set, or the date and time were reset after the camera's clock battery was exhausted. Use the charging AC adapter to charge the battery.</li><li>- Battery charging may stop if the computer is in sleep mode.</li><li>- Depending upon the computer specifications, settings, and status, battery charging may not be possible.</li></ul></li></ul>	12  84,  75 – 16, 18  – –
Camera cannot be turned on.	<ul style="list-style-type: none"><li>• The battery is exhausted.</li><li>• The power switch is enabled a few seconds after the battery is inserted. Wait a few seconds before pressing the power switch.</li></ul>	20 –





















Problem	Cause/Solution	
Camera turns off without warning.	<ul style="list-style-type: none"> <li>The camera automatically turns off to save power (auto off function).</li> <li>The camera or battery has become too cold and cannot operate properly.</li> <li>The inside of the camera has become hot. Leave the camera off until the inside of the camera has cooled, and then try turning it on again.</li> <li>The camera turns off if the USB cable connecting it to a computer or printer is disconnected. Reconnect the USB cable.</li> </ul>	21  3 – 96, 99,  22
Monitor is blank.	<ul style="list-style-type: none"> <li>The camera is off.</li> <li>The camera has entered standby mode to save power. Press the power switch, shutter-release button,  button, or  (  movie-record) button, or rotate the mode dial.</li> <li>The flash lamp flashes while the flash is charging. Wait for the flash to charge.</li> <li>The camera and computer are connected via the USB cable.</li> <li>The camera and TV are connected via an HDMI cable.</li> <li>The camera and smart device are connected using Wi-Fi connection and the camera is operated by remote control.</li> </ul>	20 1, 21  50 96, 99  96,  20 93
Monitor is hard to read.	<ul style="list-style-type: none"> <li>Adjust the monitor brightness.</li> <li>The monitor is dirty. Clean the monitor.</li> </ul>	83,  66  6
Date and time of recording are not correct.	<ul style="list-style-type: none"> <li>If the camera clock has not been set, the “Date not set” indicator flashes during shooting and movie recording. Images and movies saved before the clock is set are dated “00/00/0000 00:00” and “01/01/2014 00:00” respectively. Set the correct time and date from the <b>Time zone and date</b> option in the setup menu.</li> <li>The camera clock is not as accurate as ordinary watches or clocks. Periodically compare the time of the camera clock with that of a more accurate timepiece and reset as required.</li> </ul>	16, 83,  64



Problem	Cause/Solution	
No indicators displayed in monitor.	<b>Hide info</b> is selected for <b>Photo info</b> in <b>Monitor settings</b> in the setup menu.	83,  66
<b>Print date</b> not available.	<b>Time zone and date</b> has not been set in the setup menu.	16, 83,  64
Date not imprinted on images even when <b>Print date</b> is enabled.	<ul style="list-style-type: none"> <li>• The current shooting mode does not support <b>Print date</b>.</li> <li>• A function that restricts the print date is enabled.</li> <li>• The date cannot be imprinted on movies.</li> </ul>	 68  64  –
Screen for setting time zone and date is displayed when camera is turned on. <hr/> Camera settings reset.	The clock battery is exhausted; all settings were restored to their default values.	16, 18
Camera becomes hot.	The camera may become hot when used for an extended period of time to record movies or send images using an Eye-Fi card, or when used in a hot environment; this is not a malfunction.	–
Camera makes sound.	Depending on the <b>Autofocus mode</b> setting or the shooting mode, the camera may produce an audible focusing sound.	62, 80
Unable to select a menu	<ul style="list-style-type: none"> <li>• Some functions cannot be used with other menu options.</li> <li>• Some menus are not available when Wi-Fi is connected. Terminate the Wi-Fi connection.</li> </ul>	64  95

## Shooting Issues





Problem	Cause/Solution	
Cannot switch to shooting mode.	Disconnect the HDMI cable or USB cable.	96, 99,  20,  22
No image captured when the shutter-release button is pressed.	<ul style="list-style-type: none"> <li>• When the camera is in playback mode, press the  button, the shutter-release button, or the  button.</li> <li>• When menus are displayed, press the <b>MENU</b> button.</li> <li>• The battery is exhausted.</li> <li>• When the flash lamp is flashing, the flash is charging.</li> <li>• The camera and smart device are connected using Wi-Fi connection and the camera is operated by remote control.</li> </ul>	1, 28  4  20 50  93
Camera cannot focus.	<ul style="list-style-type: none"> <li>• The subject is too close. Try shooting using <b>Scene auto selector</b> or <b>Close-up</b> scene mode, or macro mode.</li> <li>• The subject is hard to focus on.</li> <li>• Set <b>AF assist</b> in the setup menu to <b>Auto</b>.</li> <li>• Turn the camera off and then on again.</li> </ul>	33, 35, 54  70 83,  70 20
Images are blurred.	<ul style="list-style-type: none"> <li>• Use the flash.</li> <li>• Increase the ISO sensitivity value.</li> <li>• Enable vibration reduction or motion detection.</li> <li>• Use <b>BSS</b> (Best Shot Selector).</li> <li>• Use a tripod to stabilize the camera when shooting (using the self-timer at the same time is more effective).</li> </ul>	50 62 83  36, 62,  34 53
Bright specks appear in images captured with flash.	The flash is reflecting off particles in the air. Set the flash mode setting to  (off).	52







Problem	Cause/Solution	
Flash does not fire.	<ul style="list-style-type: none"> <li>• The flash mode is set to  (off).</li> <li>• A shooting mode that restricts the flash is selected.</li> <li>• <b>On</b> is selected for <b>Blink proof</b> in the smart portrait menu.</li> <li>• <b>On (continuous)</b> or <b>On (BSS)</b> is selected for <b>Smile timer</b> in the smart portrait menu.</li> <li>• A function that restricts the flash is enabled.</li> </ul>	50 59 63 63 64
Digital zoom cannot be used.	<ul style="list-style-type: none"> <li>• <b>Digital zoom</b> is set to <b>Off</b> or <b>Crop</b> in the setup menu.</li> <li>• Digital zoom cannot be used in the following situations.                             <ul style="list-style-type: none"> <li>- When the scene mode is <b>Scene auto selector, Portrait, Night portrait, Night landscape, Backlighting</b> with <b>HDR</b> set to <b>On, Easy panorama</b> or <b>Pet portrait</b></li> <li>- When smart portrait mode is selected</li> <li>- When <b>Continuous</b> in the shooting menu is set to <b>Multi-shot 16</b></li> <li>- When <b>AF area mode</b> in the shooting menu is set to <b>Subject tracking</b></li> </ul> </li> <li>• Other functions that restrict the use of digital zoom are set.</li> </ul>	83,  71  32  39 62,  34 62,  38 64
<b>Image size</b> not available.	A function that restricts the <b>Image size</b> option is enabled.	64
No sound when shutter is released.	<b>Off</b> is selected for <b>Sound settings &gt; Shutter sound</b> in the setup menu. No sound is produced with some shooting modes and settings, even when <b>On</b> is selected.	83,  72
AF-assist illuminator does not light.	<b>Off</b> is selected for the <b>AF assist</b> option in the setup menu. AF-assist illuminator may not light depending on the position of the focus area or the current scene mode, even when <b>Auto</b> is selected.	83,  70
Images appear smeared.	The lens is dirty. Clean the lens.	 :6
Colors are unnatural.	White balance or hue is not adjusted properly.	35, 62,  31

Problem	Cause/Solution	
Randomly spaced bright pixels (“noise”) appear in image.	The subject is dark, and the shutter speed is too slow or ISO sensitivity is too high. Noise can be reduced by: <ul style="list-style-type: none"> <li>• Using the flash.</li> <li>• Specifying a lower ISO sensitivity setting.</li> </ul>	50 62,  37
Images are too dark (underexposed).	<ul style="list-style-type: none"> <li>• The flash mode is set to  (off).</li> <li>• The flash window is blocked.</li> <li>• The subject is beyond the range of the flash.</li> <li>• Adjust exposure compensation.</li> <li>• Increase ISO sensitivity.</li> <li>• The subject is backlit. Set the scene mode to <b>Backlighting</b> with <b>HDR</b> set to <b>Off</b>, or set the flash mode to .</li> </ul>	50 24 50  58 62,  37 36, 50
Images are too bright (overexposed).	Adjust exposure compensation.	58
Unexpected results when flash set to  (auto with red-eye reduction/red-eye reduction).	When taking images with  (auto with red-eye reduction/red-eye reduction) or <b>Scene auto selector</b> , In-Camera Red Eye Fix may be applied to areas not affected by red-eye in rare cases. Use any shooting mode other than <b>Night portrait</b> , and change the flash mode to any setting other than  (auto with red-eye reduction/red-eye reduction) and try taking an image again.	33, 34, 50
Skin tones are not softened.	<ul style="list-style-type: none"> <li>• In some shooting conditions, facial skin tones may not be softened.</li> <li>• For images containing four or more faces, try using the <b>Skin softening</b> effect in <b>Glamour retouch</b> in the playback menu.</li> </ul>	39  74,  17

Problem	Cause/Solution	
Saving images takes time.	<p>It may take more time to save images in the following situations.</p> <ul style="list-style-type: none"> <li>• When the noise reduction function is in operation, such as when shooting in a dark environment</li> <li>• When the flash mode is set to  (auto with red-eye reduction/red-eye reduction)</li> <li>• When taking images in the following scene modes               <ul style="list-style-type: none"> <li>- <b>Hand-held</b> in <b>Night portrait</b></li> <li>- <b>Hand-held</b> in <b>Night landscape</b></li> <li>- <b>HDR</b> set to <b>On</b> in <b>Backlighting</b></li> <li>- <b>Easy panorama</b></li> </ul> </li> <li>• When the skin softening function is applied while shooting</li> <li>• When using continuous shooting mode</li> </ul>	<p style="text-align: center;">–</p> <p style="text-align: right;">52</p> <p style="text-align: right;">34</p> <p style="text-align: right;">35</p> <p style="text-align: right;">36</p> <p style="text-align: right;">37</p> <p style="text-align: right;">63</p> <p style="text-align: right;">62, 34</p>
A ring-shaped belt or rainbow-colored stripe appears in the monitor or images.	<p>When shooting with backlighting or when a very strong light source (such as sunlight) is in the frame, a ring-shaped belt or rainbow-colored stripe (ghosting) may occur. Change the position of the light source, or frame the image so that the light source does not enter the frame, and try again.</p>	<p style="text-align: center;">–</p>







## Playback Issues





Problem	Cause/Solution	
File cannot be played back.	<ul style="list-style-type: none"> <li>• This camera may not be able to play back images saved with another make or model of digital camera.</li> <li>• This camera cannot play back movies recorded with another make or model of digital camera.</li> <li>• This camera may not be able to play back data edited on a computer.</li> </ul>	-
Cannot zoom in on image.	<ul style="list-style-type: none"> <li>• Playback zoom cannot be used with movies.</li> <li>• When zooming in on a small-sized image, the zoom ratio shown on the screen may differ from the actual zoom ratio of the image.</li> <li>• This camera may not be able to zoom in on images captured with another make or model of digital camera.</li> </ul>	-
Cannot record voice memos.	<ul style="list-style-type: none"> <li>• Voice memos cannot be attached to movies.</li> <li>• Voice memos cannot be attached to images captured with other cameras. Voice memos attached to images using another camera cannot be played back on this camera.</li> </ul>	- 74,  52
Cannot edit image.	<ul style="list-style-type: none"> <li>• Some images cannot be edited. Images that have already been edited may not be edited again.</li> <li>• There is not enough free space in the internal memory or on the memory card.</li> <li>• This camera is unable to edit images captured with other cameras.</li> <li>• Editing functions used for images are not available for movies.</li> </ul>	37,  13 - 74,  13 -
Cannot rotate image.	This camera cannot rotate images captured with another make or model of digital camera.	-

Problem	Cause/Solution	
Images are not displayed on TV.	<ul style="list-style-type: none"> <li>• <b>HDMI</b> is not correctly set in the <b>TV settings</b> setup menu.</li> <li>• A computer or printer is connected to the camera.</li> <li>• The memory card contains no images. Replace the memory card. Remove the memory card to play back images from the internal memory.</li> </ul>	84,  74 96, 99,  22 15
Nikon Transfer 2 does not start when camera is connected to a computer.	<ul style="list-style-type: none"> <li>• The camera is off.</li> <li>• The battery is exhausted.</li> <li>• The USB cable is not correctly connected.</li> <li>• The camera is not recognized by the computer.</li> <li>• The computer is not set to start Nikon Transfer 2 automatically. For more information about Nikon Transfer 2, refer to help information contained in ViewNX 2.</li> </ul>	20 20 96, 99 –  101
The PictBridge startup screen is not displayed when the camera is connected to a printer.	With some PictBridge-compatible printers, the PictBridge startup screen may not be displayed and it may be impossible to print images when <b>Auto</b> is selected for the <b>Charge by computer</b> option in the setup menu. Set the <b>Charge by computer</b> option to <b>Off</b> and reconnect the camera to the printer.	84,  75
Images to be printed are not displayed.	<ul style="list-style-type: none"> <li>• The memory card contains no images. Replace the memory card.</li> <li>• Remove the memory card to print images from the internal memory.</li> </ul>	14 15
Cannot select paper size with camera.	The camera cannot be used to select the paper size in the following situations, even when printing from a PictBridge-compatible printer. Use the printer to select the paper size. <ul style="list-style-type: none"> <li>• The printer does not support the paper sizes specified by the camera.</li> <li>• The printer automatically selects the paper size.</li> </ul>	96,  24,  25 –



## Location Data Functions

Problem	Cause/Solution	
Unable to identify the location or it takes time to identify the location.	<ul style="list-style-type: none"> <li>The camera may not be able to identify the location in some shooting environments. To use the location data functions, use the camera as much as possible in an open-air area.</li> </ul>	86
	<ul style="list-style-type: none"> <li>When positioning for the first time or when positioning was unable to be performed for about two hours, it takes a few minutes to obtain the location data.</li> </ul>	86
Unable to record location data on shot images.	When  or  is displayed on the shooting screen, the location data is not recorded. Before shooting images, check the location data reception.	87
Difference between the actual shooting location and recorded location data.	The acquired location data may deviate in some shooting environments. When there is a significant difference in the signals from the positioning satellites, there could be a deviation of up to several hundred meters.	86
The recorded location name is different from the intended one or is not displayed.	The desired landmark name may not be registered, or a different landmark name may be registered.	-
Unable to update the A-GPS file.	<ul style="list-style-type: none"> <li>Check the following items.               <ul style="list-style-type: none"> <li>Whether the memory card is inserted</li> <li>Whether the A-GPS file is stored on the memory card</li> <li>Whether the A-GPS file saved on the memory card is more recent than the A-GPS file saved in the camera</li> <li>Whether the A-GPS file is still valid</li> </ul> </li> <li>The A-GPS file may be corrupted. Download the file from the website once more.</li> </ul>	- 91,  79
Unable to display the map.	Maps cannot be displayed while the camera is being charged with the charging AC adapter, even if the  (map) button is pressed.	-
Unable to select <b>Create log</b> in the Location data options menu.	Clock not set. Set date and time.	83,  64

Problem	Cause/Solution	
Unable to select <b>Start log</b> .	<ul style="list-style-type: none"> <li>• <b>Record location data</b> in the Location data options menu is set to <b>Off</b>.</li> <li>• The camera is recording log data. To record a new log, select <b>End log</b>, and end the log currently being recorded.</li> </ul>	85 91,  83
Unable to save log data.	<ul style="list-style-type: none"> <li>• Make sure that a memory card is inserted in the camera.</li> <li>• Up to 36 log data events can be recorded per day.</li> <li>• The total number of log data events that can be saved on a single memory card is up to 100. Delete log data that is no longer required from a memory card or replace the memory card with a new one.</li> </ul>	– –  84,  85

## Wi-Fi

Problem	Cause/Solution	
SSID (network name) of the camera is not displayed on the smart device.	<p>Select <b>Connect to smart device</b> in the Wi-Fi options menu on the camera to enter connection standby mode.</p> <p>Turn off the Wi-Fi function of the smart device and then turn it on again.</p>	94

# USER LICENSE AGREEMENT FOR MAP DATA AND LOCATION NAME DATA

The map data and location name data that are stored in this digital camera ("Data") is provided for your personal, internal use only and not for resale. It is protected by copyright, and is subject to the following terms and conditions which are agreed to by you, on the one hand, and Nikon Corporation ("Nikon") and its licensors (including their licensors and suppliers) on the other hand.

## Terms and Conditions

Personal Use Only. You agree to use this Data together with this digital camera and the image data taken by the digital camera for the solely personal, non-commercial purposes for which you were licensed, and not for service bureau, time-sharing or other similar purposes.

Accordingly, but subject to the restrictions set forth in the following paragraphs, you agree not to otherwise reproduce, copy, modify, decompile, disassemble or reverse engineer any portion of this Data, and may not transfer or distribute it in any form, for any purpose, except to the extent permitted by mandatory laws.

Restrictions. Except where you have been specifically licensed to do so by Nikon, and without limiting the preceding paragraph, you may not (a) use this Data with any products, systems, or applications installed or otherwise connected to or in communication with vehicles, capable of vehicle navigation, positioning, dispatch, real time route guidance, fleet management or similar applications; or (b) with or in communication with any positioning devices or any mobile or wireless-connected electronic or computer devices, including without limitation cellular phones, palmtop and handheld computers, pagers, and personal digital assistants or PDAs.

Warning. The Data may contain inaccurate or incomplete information due to the passage of time, changing circumstances, sources used and the nature of collecting comprehensive geographic data, any of which may lead to incorrect results.

No Warranty. This Data is provided to you "as is," and you agree to use it at your own risk. Nikon and its licensors (and their licensors and suppliers) make no guarantees, representations or warranties of any kind, express or implied, arising by law or otherwise, including but not limited to, content, quality, accuracy, completeness, effectiveness, reliability, fitness for a particular purpose, usefulness, use or results to be obtained from this Data, or that the Data or server will be uninterrupted or error-free.

Disclaimer of Warranty: NIKON AND ITS LICENSORS (INCLUDING THEIR LICENSORS AND SUPPLIERS) DISCLAIM ANY WARRANTIES, EXPRESS OR IMPLIED, OF QUALITY, PERFORMANCE, MERCHANTABILITY, FITNESS FOR A PARTICULAR PURPOSE OR NON-INFRINGEMENT. Some States, Territories and Countries do not allow certain warranty exclusions, so to that extent the above exclusion may not apply to you.

Disclaimer of Liability: NIKON AND ITS LICENSORS (INCLUDING THEIR LICENSORS AND SUPPLIERS) SHALL NOT BE LIABLE TO YOU: IN RESPECT OF ANY CLAIM, DEMAND OR ACTION, IRRESPECTIVE OF THE NATURE OF THE CAUSE OF THE CLAIM, DEMAND OR ACTION ALLEGING ANY LOSS, INJURY OR DAMAGES, DIRECT OR INDIRECT, WHICH MAY RESULT FROM THE USE OR POSSESSION OF THE INFORMATION; OR FOR ANY LOSS OF PROFIT, REVENUE, CONTRACTS OR SAVINGS, OR ANY OTHER DIRECT, INDIRECT, INCIDENTAL, SPECIAL OR CONSEQUENTIAL DAMAGES ARISING OUT OF YOUR USE OF OR INABILITY TO USE THIS INFORMATION, ANY DEFECT IN THE INFORMATION, OR THE BREACH OF THESE TERMS OR CONDITIONS, WHETHER IN AN ACTION IN CONTRACT OR TORT OR BASED ON A WARRANTY, EVEN IF NIKON OR ITS LICENSORS HAVE BEEN ADVISED OF THE POSSIBILITY OF SUCH DAMAGES. Some States, Territories and Countries do not allow certain liability exclusions or damages limitations, so to that extent the above may not apply to you.

Export Control. You agree not to export from anywhere any part of the Data or any direct product thereof except in compliance with, and with all licenses and approvals required under, applicable export laws, rules and regulations, including but not limited to the laws, rules and regulations administered by the Office of Foreign Assets Control of the U.S. Department of Commerce and the Bureau of Industry and Security of the U.S. Department of Commerce. To the extent that any such export laws, rules or regulations prohibit Nikon and its licensors from complying with any of its obligations hereunder to deliver or distribute Data, such failure shall be excused and shall not constitute a breach of this Agreement.

Entire Agreement. These terms and conditions constitute the entire agreement between Nikon (and its licensors, including their licensors and suppliers) and you pertaining to the subject matter hereof, and supersedes in their entirety any and all written or oral agreements previously existing between us with respect to such subject matter.

Governing Law. The above terms and conditions shall be governed by the laws of the Japan, without giving effect to (i) its conflict of laws provisions, or (ii) the United Nations Convention for Contracts for the International Sale of Goods, which is explicitly excluded; provided that in the event that the laws of the Japan is not deemed applicable to this Agreement for any reason in the country where you obtained the Data, this Agreement shall be governed with the laws of the country where you obtained the Data. You agree to submit to the jurisdiction of Japan for any and all disputes, claims and actions arising from or in connection with the Data provided to you hereunder.

Government End Users. If the Data supplied by HERE is being acquired by or on behalf of the United States government or any other entity seeking or applying rights similar to those customarily claimed by the United States government, the Data is a "commercial item" as that term is defined at 48 C.F.R. ("FAR") 2.101, is licensed in accordance with the End-User Terms under which this Data was provided, and each copy of the Data delivered or otherwise furnished shall be marked and embedded as appropriate with the following "Notice of Use," and shall be treated in accordance with such Notice:

NOTICE OF USE  
CONTRACTOR (MANUFACTURER/ SUPPLIER) NAME:  
HERE  
CONTRACTOR (MANUFACTURER/SUPPLIER) ADDRESS:  
425 West Randolph Street, Chicago, Illinois 60606  
This Data is a commercial item as defined in  
FAR 2.101 and is subject to the End-User  
Terms under which this Data was provided.  
© 2013 HERE - All rights reserved.

If the Contracting Officer, federal government agency, or any federal official refuses to use the legend provided herein, the Contracting Officer, federal government agency, or any federal official must notify HERE prior to seeking additional or alternative rights in the Data.

## Notices related to licensed software copyright holders.

- Map data and location name data for Japan



© 2013 ZENRIN CO., LTD. All rights reserved.  
This service uses map and POI data of ZENRIN CO., LTD.  
"ZENRIN" is a registered trademark of ZENRIN CO., LTD.

- Map data and location name data except for Japan



Maps for Life

© 1987-2013 HERE  
All rights reserved.

Austria	© Bundesamt für Eich- und Vermessungswesen
Croatia Cyprus Estonia Latvia Lithuania Moldova Poland Slovenia Ukraine	© EuroGeographics
France	source: © IGN 2009 - BD TOPO ®
Germany	Die Grundlagendaten wurden mit Genehmigung der zuständigen Behörden entnommen
Great Britain	Contains Ordnance Survey data © Crown copyright and database right 2010 Contains Royal Mail data © Royal Mail copyright and database right 2010

Greece	Copyright Geomatics Ltd.
Hungary	Copyright © 2003; Top-Map Ltd.
Italy	La Banca Dati Italiana è stata prodotta usando quale riferimento anche cartografia numerica ed al tratto prodotta e fornita dalla Regione Toscana.
Norway	Copyright © 2000; Norwegian Mapping Authority
Portugal	Source: IgeoE - Portugal
Spain	Información geográfica propiedad del CNIG
Sweden	Based upon electronic data © National Land Survey Sweden.
Switzerland	Topografische Grundlage: © Bundesamt für Landestopographie
United Kingdom	Contains public sector information licensed under the Open Government Licence v1.0 (see for the license <a href="http://www.nationalarchives.gov.uk/doc/open-government-licence/">http://www.nationalarchives.gov.uk/doc/open-government-licence/</a> ) Adapted from data from the office for National Statistics licensed under the Open Government Licence v.1.0
Canada	This data includes information taken with permission from Canadian authorities, including © Her Majesty, © Queen's Printer for Ontario, © Canada Post, GeoBase ®, © Department of Natural Resources Canada. All rights reserved.
Mexico	Fuente: INEGI (Instituto Nacional de Estadística y Geografía.)
United States	© United States Postal Service ® 2013. Prices are not established, controlled or approved by the United States Postal Service ®. The following trademarks and registrations are owned by the USPS: United States Postal Service, USPS, and ZIP+4.
Australia	Copyright. Based on data provided under license from PSMA Australia Limited ( <a href="http://www.psm.com.au">www.psm.com.au</a> ). Product incorporates data which is © 2013 Telstra Corporation Limited, Intelomatics Australia Pty Ltd and HERE International LLC.
Nepal	Copyright © Survey Department, Government of Nepal.
Sri Lanka	This product incorporates original source digital data obtained from the Survey Department of Sri Lanka © 2009 Survey Department of Sri Lanka The data has been used with the permission of the Survey Department of Sri Lanka

<b>Israel</b>	© Survey of Israel data source
<b>Jordan</b>	© Royal Jordanian Geographic Centre.
<b>Mozambique</b>	Certain Data for Mozambique provided by Cenacarta © 2013 by Cenacarta
<b>Nicaragua</b>	The Pacific Ocean and Caribbean Sea maritime borders have not been entirely defined. Northern land border defined by the natural course of the Coco River (also known as Segovia River or Wangki River) corresponds to the source of information available at the moment of its representation.
<b>Réunion</b>	source: © IGN 2009 - BD TOPO ®
<b>Ecuador</b>	INSTITUTO GEOGRAFICO MILITAR DEL ECUADRO AUTORIZACION N° IGM-2011-01- PCO-01 DEL 25 DE ENERO DE 2011
<b>Guadeloupe</b>	source: © IGN 2009 - BD TOPO ®
<b>Guatemala</b>	Aprobado por el INSTITUTO GEOGRAFICO NACIONAL - Resolución del IGN N° 186-2011
<b>French Guiana</b>	source: © IGN 2009 - BD TOPO ®
<b>Martinique</b>	source: © IGN 2009 - BD TOPO ®



# Specifications

## Nikon COOLPIX S9700 Digital Camera

Type	Compact digital camera
Number of effective pixels	16.0 million
Image sensor	1/2.3-in. type CMOS; approx. 16.76 million total pixels
Lens	NIKKOR lens with 30× optical zoom
Focal length	4.5-135 mm (angle of view equivalent to that of 25-750 mm lens in 35mm [135] format)
f/-number	f/3.7-6.4
Construction	13 elements in 11 groups (3 ED lens elements)
Digital zoom magnification	Up to 4× (angle of view equivalent to that of approx. 3000 mm lens in 35mm [135] format)
Vibration reduction	Combination of lens shift and electronic VR
Motion blur reduction	Motion detection (still pictures)
Autofocus (AF)	Contrast-detect AF
Focus range	<ul style="list-style-type: none"><li>• [W]: Approx. 50 cm (1 ft 8 in.) - ∞,</li><li>  [T]: Approx. 2.0 m (6 ft 7 in.) - ∞</li><li>• Macro mode: Approx. 1 cm (0.4 in.) - ∞ (wide-angle position)</li></ul> (All distances measured from center of front surface of lens)
Focus-area selection	Face priority, manual with 99 focus areas, center, subject tracking, target finding AF
Monitor	7.5 cm (3-in.), approx. 921k-dot, wide viewing angle OLED monitor with anti-reflection coating and 5-level brightness adjustment
Frame coverage (shooting mode)	Approx. 98% horizontal and 98% vertical (compared to actual picture)
Frame coverage (playback mode)	Approx. 100% horizontal and 100% vertical (compared to actual picture)
Storage	
Media	Internal memory (approx. 329 MB) SD/SDHC/SDXC memory card
File system	DCF, Exif 2.3, and DPOF compliant
File formats	Still pictures: JPEG Sound files (voice memo): WAV Movies: MOV (video: H.264/MPEG-4 AVC, Audio: LPCM stereo)

Image size (pixels)	<ul style="list-style-type: none"> <li>• 16M <b>4608×3456</b></li> <li>• 8M <b>3264×2448</b></li> <li>• 4M <b>2272×1704</b></li> <li>• 2M <b>1600×1200</b></li> <li>• VGA <b>640×480</b></li> <li>• 16:9 12M <b>4608×2592</b></li> <li>• 1:1 <b>3456×3456</b></li> </ul>
ISO sensitivity (Standard output sensitivity)	<ul style="list-style-type: none"> <li>• ISO 125 - 1600</li> <li>• ISO 3200, 6400 (available when using <b>P, S, A,</b> or <b>M</b> mode)</li> </ul>
Exposure	
Metering mode	Matrix, center-weighted, spot (digital zoom 2× or more)
Exposure control	Programmed auto exposure with flexible program, shutter-priority auto, aperture-priority auto, manual, and exposure compensation (-2.0 - +2.0 EV in steps of 1/3 EV)
Shutter	Mechanical and CMOS electronic shutter
Speed	<ul style="list-style-type: none"> <li>• 1/2000 - 1 s</li> <li>• 1/2000 - 8 s (when ISO sensitivity is fixed at ISO 125 or 200 in <b>S, A*</b>, or <b>M</b> mode)</li> <li>• 1/4000 s (maximum speed during high-speed continuous shooting)</li> </ul> <p>* When the aperture value is f/5.6 - 8 at the wide-angle position</p>
Aperture	Electronically-controlled 3-blade iris diaphragm
Range	14 steps of 1/6 EV (W) ( <b>A, M</b> mode)
Self-timer	Can be selected from 10 s and 2 s
Flash	
Range (approx.) (ISO sensitivity: Auto)	[W]: 0.5 - 6.0 m (1 ft 8 in. - 19 ft) [T]: 1.5 - 3.5 m (5 - 11 ft)
Flash control	TTL auto flash with monitor preflashes
Interface	Hi-Speed USB equivalent
Data transfer protocol	MTP, PTP
HDMI output	Can be selected from Auto, 480p, 720p, and 1080i
I/O terminal	<ul style="list-style-type: none"> <li>• Micro-USB connector</li> <li>• HDMI micro connector (Type D) (HDMI output)</li> </ul>

<b>Wi-Fi (Wireless LAN)</b>	
Standards	IEEE 802.11b/g/n (standard wireless LAN protocol) ARIB STD-T66 (standard for low power data communication systems)
Communications protocols	IEEE 802.11b: DBPSK/DQPSK/CCK IEEE 802.11g: OFDM IEEE 802.11n: OFDM
Range (line of sight)	Approx. 30 m (32 yd)
Operating frequency	2412 - 2462 MHz (1 - 11 channels)
Data rates (actual measured values)	IEEE 802.11b: 5 Mbps IEEE 802.11g: 15 Mbps IEEE 802.11n: 15 Mbps
Security	OPEN/WPA2
Access protocols	CSMA/CA
Electronic compass	16 cardinal points (position correction using 3-axis acceleration sensor, automatic correction for the deviated angle, and automatic offset adjustment)
Location data	<ul style="list-style-type: none"> <li>• <b>GPS</b> Receiving frequency: 1575.42 MHz Geodetic system: WGS 84</li> <li>• <b>GLONASS</b> Receiving frequency: 1598.0625 MHz - 1605.3750 MHz Geodetic system: WGS 84</li> </ul>
Supported languages	Arabic, Bengali, Bulgarian, Chinese (Simplified and Traditional), Czech, Danish, Dutch, English, Finnish, French, German, Greek, Hindi, Hungarian, Indonesian, Italian, Japanese, Korean, Marathi, Norwegian, Persian, Polish, Portuguese (European and Brazilian), Romanian, Russian, Serbian, Spanish, Swedish, Tamil, Telugu, Thai, Turkish, Ukrainian, Vietnamese
Power sources	One Rechargeable Li-ion Battery EN-EL12 (included) AC Adapter EH-62F (available separately)
Charging time	Approx. 2 h 20 min (when using Charging AC Adapter EH-71P and when no charge remains)
<b>Battery life<sup>1</sup></b>	
Still pictures	Approx. 300 shots when using EN-EL12
Movies (actual battery life for recording) <sup>2</sup>	Approx. 1 h 5 min when using EN-EL12
Tripod socket	1/4 (ISO 1222)

<b>Dimensions (W × H × D)</b>	Approx. 109.6 × 63.5 × 34.5 mm (4.4 × 2.5 × 1.4 in.) (excluding projections)
<b>Weight</b>	Approx. 232 g (8.2 oz) (including battery and SD memory card)
<b>Operating environment</b>	
<b>Temperature</b>	0°C - 40°C (32°F - 104°F)
<b>Humidity</b>	85% or less (no condensation)

- Unless otherwise stated, all figures assume a fully-charged battery and an ambient temperature of 23 ±3°C (73.4 ±5.4°F) as specified by the Camera and Imaging Products Association (CIPA).
- 1 Battery life may vary depending on conditions of use, such as the interval between shots or the length of time that menus and images are displayed.
  - 2 Individual movie files cannot exceed 4 GB in size or 29 minutes in length. Recording may end before this limit is reached if camera temperature becomes elevated.

## Rechargeable Li-ion Battery EN-EL12

<b>Type</b>	Rechargeable lithium-ion battery
<b>Rated capacity</b>	DC 3.7 V, 1050 mAh
<b>Operating temperature</b>	0°C - 40°C (32°F - 104°F)
<b>Dimensions (W × H × D)</b>	Approx. 32 × 43.8 × 7.9 mm (1.3 × 1.7 × 0.3 in.)
<b>Weight</b>	Approx. 22.5 g (0.8 oz)

## Charging AC Adapter EH-71P

<b>Rated input</b>	AC 100 - 240 V, 50/60 Hz, MAX 0.2 A
<b>Rated output</b>	DC 5.0 V, 1.0 A
<b>Operating temperature</b>	0°C - 40°C (32°F - 104°F)
<b>Dimensions (W × H × D)</b>	Approx. 55 × 22 × 54 mm (2.2 × 0.9 × 2.2 in.) (excluding plug adapter) For Argentina: Approx. 55 × 63 × 59 mm (2.2 × 2.5 × 2.4 in.) For Brazil: Approx. 55 × 67 × 59 mm (2.2 × 2.7 × 2.4 in.)
<b>Weight</b>	Approx. 48 g (1.7 oz) (excluding plug adapter) For Argentina: Approx. 73 g (2.6 oz) For Brazil: Approx. 70 g (2.5 oz)

### Specifications

- Nikon will not be held liable for any errors this manual may contain.
- The appearance of this product and its specifications are subject to change without notice.

## Approved Memory Cards

The following Secure Digital (SD) memory cards have been tested and approved for use in this camera.

- Memory cards with an SD Speed Class rating of 6 or faster are recommended for recording movies. When using a memory card with a lower Speed Class rating, movie recording may stop unexpectedly.

	SD memory card	SDHC memory card <sup>2</sup>	SDXC memory card <sup>3</sup>
SanDisk	2 GB <sup>1</sup>	4 GB, 8 GB, 16 GB, 32 GB	64 GB, 128 GB
TOSHIBA	–	4 GB, 8 GB, 16 GB, 32 GB	64 GB
Panasonic	2 GB <sup>1</sup>	4 GB, 8 GB, 16 GB, 32 GB	64 GB
Lexar	–	4 GB, 8 GB, 16 GB, 32 GB	64 GB, 128 GB

<sup>1</sup> If the memory card will be used with a card reader or similar device, make sure that the device supports 2 GB cards.

<sup>2</sup> SDHC compliant.

If the memory card will be used with a card reader or similar device, make sure that the device supports SDHC.



<sup>3</sup> SDXC compliant.

If the memory card will be used with a card reader or similar device, make sure that the device supports SDXC.



- Contact the manufacturer for details on the above cards. We cannot guarantee camera performance when using memory cards made by other manufacturers.

## AVC Patent Portfolio License

This product is licensed under the AVC Patent Portfolio License for the personal and non-commercial use of a consumer to (i) encode video in compliance with the AVC standard (“AVC video”) and/or (ii) decode AVC video that was encoded by a consumer engaged in a personal and non-commercial activity and/or was obtained from a video provider licensed to provide AVC video. No license is granted or shall be implied for any other use. Additional information may be obtained from MPEG LA, L.L.C.

See <http://www.mpegla.com>.

## FreeType License (FreeType2)

Portions of this software are copyright © 2012 The FreeType Project (<http://www.freetype.org>). All rights reserved.

## MIT License (HarfBuzz)

Portions of this software are copyright © 2014 The HarfBuzz Project (<http://www.freedesktop.org/wiki/Software/HarfBuzz>). All rights reserved.

## Trademark Information

- Microsoft, Windows and Windows Vista are either registered trademarks or trademarks of Microsoft Corporation in the United States and/or other countries.
- Mac, OS X, the iFrame logo and the iFrame symbol are trademarks or registered trademarks of Apple Inc., in the U.S. and other countries.
- Adobe and Acrobat are registered trademarks of Adobe Systems Inc.
- SDXC, SDHC and SD Logos are trademarks of SD-3C, LLC.
- PictBridge is a trademark.
- HDMI, HDMI logo and High-Definition Multimedia Interface are trademarks or registered trademarks of HDMI Licensing LLC.

### **HDMI**

- Wi-Fi and the Wi-Fi logo are trademarks or registered trademarks of the Wi-Fi Alliance.
- Android and Google Play are trademarks or registered trademarks of Google, Inc.
- All other trade names mentioned in this manual or the other documentation provided with your Nikon product are trademarks or registered trademarks of their respective holders.

# Index

## Symbols

**A** Aperture-priority auto mode ..... 43, 46

 Auto mode ..... 22, 31

 Auto sort mode ..... 9

 Delete button... 29, 82, 52

 Exposure compensation ..... 56, 58

 Favorite pictures mode..... 5

 Flash mode ..... 50

 Help ..... 33

 List by date mode..... 10

 Macro mode ..... 54

**M** Manual mode ..... 43, 46

 Map button ..... 88

**MENU** Menu button ..... 4, 61, 74, 80, 83, 91

 (  movie-record) button ..... 2, 76

 Playback button ..... 2, 28

 Playback mode..... 28

 Playback zoom ..... 72

**P** Programmed auto mode ..... 43, 46

**SCENE** Scene mode..... 32

 Self-timer..... 53

**S** Shutter-priority auto mode ..... 43, 46

 Smart portrait mode ..... 39

**EFFECTS** Special effects mode..... 41

**T** (Telephoto) ..... 25

 Thumbnail playback..... 73



**W** (Wide-angle) ..... 25  
.JPG..... 96

.log ..... 96

.MOV ..... 96

.WAV ..... 96

**A**  
AC adapter ..... 96, 97

AF area mode ..... 62, 80, 38, 59

AF assist ..... 83, 70

AF-assist illuminator..... 1

A-GPS file ..... 91, 79

Album ..... 5

Aperture value..... 27, 43

Aperture-priority auto mode ..... 43, 46



Auto flash ..... 52

Auto mode ..... 22, 31

Auto off..... 21, 83, 72

Auto sort mode ..... 9

Auto with red-eye reduction ..... 52

Autofocus ..... 62, 80, 41, 60

**B**  
Backlighting  ..... 36

Battery ..... 10, 12, 18

Battery charger..... 13, 97

Battery latch..... 10

Battery level indicator..... 20

Battery-chamber/memory card slot cover..... 2, 10, 14

Beach  ..... 32

Best Shot Selector ..... 36, 35

Black and white copy  ..... 36

Blink proof ..... 63, 45



Blink warning ..... 84, 76  
Brightness ..... 83, 66  
Brightness (exposure compensation) ..... 56, 58  
BSS ..... 36, 35  
Button sound ..... 72

## C

Calculate distance ..... 91, 81  
Calendar display ..... 73  
Charge by computer .... 84, 75  
Charge lamp ..... 2, 13  
Charger ..... 13, 97  
Charging AC adapter ..... 12  
Choose key picture ..... 75, 11, 54  
Close-up ..... 35  
Computer ..... 97, 99  
Continuous ..... 62, 34  
Create log ..... 91, 83  
Crop ..... 19  
Cross process ..... 42

## D

Date and time ..... 16, 83, 64  
Date format ..... 17, 64  
Daylight saving time ..... 17, 18, 64  
Delete ..... 29, 82, 12, 52  
Digital zoom ..... 25, 83, 71  
Direct print ..... 97, 21  
Displaying maps ..... 88  
Distance units ..... 91, 80  
D-Lighting ..... 74, 15  
DPOF print ..... 26  
DSCN ..... 96  
Dusk/dawn ..... 32

## E

Easy panorama ..... 37, 2  
Easy panorama playback ..... 37, 4  
Electronic compass ..... 92, 87  
Exposure compensation ..... 56, 58  
Exposure mode ..... 43  
Extension ..... 96  
Eye-Fi upload ..... 84, 77  
Eyelet for camera strap ..... 2

## F

Face detection ..... 69  
Face priority ..... 69, 80, 38, 59  
Favorite pictures ..... 75, 5  
Favorite pictures mode ..... 5  
File name ..... 96  
Fill flash ..... 52  
Fireworks show ..... 36  
Firmware version ..... 84, 78  
Fixed range auto ..... 37  
Flash ..... 1, 50  
Flash lamp ..... 2, 50  
Flash mode ..... 50, 52  
Flash off ..... 52  
Focus ..... 26, 62, 80, 38, 59  
Focus area ..... 26  
Focus indicator ..... 7  
Focus lock ..... 71  
Food ..... 35  
Format internal memory ..... 84, 73  
Format memory cards ..... 14, 84, 73  
Formatting ..... 14, 84, 73

Frame rate.....	80,	62	List by date mode .....		10
FSCN.....		96	Location data options ...	91,	79
Full-frame playback .....	72		Low key	.....	41
Full-time AF .....	80,	41,	<b>M</b>		
<b>G</b>			M exposure preview.....	62,	42
Glamour retouch.....	74,	17	Macro mode.....	54	
<b>H</b>			Manual mode .....	43, 46	
HDMI.....		74	Map display .....	88	
HDMI cable .....	97,	20	Memory capacity.....	20	
HDMI connector cover .....	2		Memory card.....	14	
HDMI device control.....		74	Memory card slot.....	14	
HDMI micro connector.....	2		Microphone .....	1	
HDR.....	36		Micro-USB connector		
Help.....	33		.....	96, 99,	22
High key	.....	41	Monitor.....	2, 6,	6
High-contrast monochrome	.....	41	Monitor settings.....	83,	66
.....	41		Motion detection .....	83,	70
High-speed continuous.....		34	Movie editing.....	82,	27
Histogram.....	56		Movie length.....	76, 77	
HS movie .....	80,	56,	Movie menu .....	80,	55
Hue.....	57		Movie options.....	80,	55
<b>I</b>			Movie playback.....	81	
Identifier.....		96	Movie recording.....	76	
Image copy .....	74,	53	Movie VR .....	80,	61
Image quality .....	62,	29	Multi selector .....	2, 4, 28, 49	
Image review .....	83,	66	Multi-shot 16.....		35
Image size.....	62,	30	Museum	.....	36
Internal memory.....	15, 20		<b>N</b>		
Internal memory indicator.....	7, 9		Night landscape	.....	35
ISO sensitivity.....	62,	37	Night portrait	.....	34
<b>L</b>			Nikon Transfer 2.....	99	
Landscape	.....	32	Nostalgic sepia <b>SEPIA</b> .....	41	
Language.....	84,	74	Number of exposures remaining		
Lens.....	1,	6,	.....	20,	29
Lens cover.....	1				

**Q**

- Open with HS footage ..... 80, 57, 59
- Optical zoom ..... 25
- Optional accessories ..... 97

**P**

- Paper size ..... 24, 25
- Party/indoor ..... 34
- Pet portrait auto release ..... 38
- Pet portrait ..... 38
- Photo info ..... 83, 66
- Photo VR ..... 83, 69
- PictBridge ..... 97, 21
- Playback ..... 28, 72, 81, 52
- Playback menu ..... 74, 46
- Playback mode ..... 28
- Playback zoom ..... 72
- Points of interest (POI) ..... 87, 91, 82

**POP**

- Pop **POP** ..... 41
- Portrait ..... 32
- Power ..... 20
- Power switch ..... 1, 20
- Power-on lamp ..... 1
- Preset manual ..... 32
- Pre-shooting cache ..... 34, 36
- Pressing halfway ..... 27
- Print ..... 74, 97, 23, 25, 46
- Print date ..... 18, 83, 68
- Print order ..... 74, 46
- Print order date option ..... 18, 47, 68
- Printer ..... 97, 21
- Programmed auto mode .... 43, 46

- Protect ..... 74, 50

**Q**

- Quick effects ..... 28, 44, 62, 14, 41
- Quick retouch ..... 74, 15

**R**

- Recording movies ..... 76
- Recording slow motion movies ..... 80, 56, 57
- Red-eye correction ..... 74, 16
- Red-eye reduction ..... 52
- Remove from favorites .... 75, 7
- Reset all ..... 84, 78
- Rotary multi selector ..... 2, 4, 28, 49
- Rotate image ..... 74, 51
- RSCN ..... 96

**S**

- Scene auto selector ..... 33
- Scene mode ..... 32, 33
- Selective color ..... 41
- Self-timer ..... 53
- Self-timer lamp ..... 1, 53
- Sequence display options ..... 75, 11, 54
- Set clock from satellite ..... 92, 86
- Setup menu ..... 83, 63
- Shooting ..... 22, 24, 26
- Shooting menu ..... 61, 31
- Shooting mode ..... 22
- Shutter sound ..... 72
- Shutter speed ..... 27, 43, 48
- Shutter-priority auto mode ..... 43, 46

- Shutter-release button ..... 1, 26
- Single ..... 62, 34
- Single AF ..... 80, 41, 60
- Skin softening ..... 63, 70, 43
- Slide show ..... 74, 49
- Slow sync ..... 52
- Small picture ..... 74, 18
- Smart portrait menu ..... 61, 43
- Smart portrait mode ..... 39
- Smile timer ..... 63, 44
- Snow ..... 32
- Soft **SOFT** ..... 41
- Sound settings ..... 83, 72
- Speaker ..... 2
- Special effects mode ..... 41
- Sports ..... 34
- SSCN ..... 96
- Standard flash ..... 52
- Strap ..... 3
- Subject tracking ..... 39, 40
- Sunset ..... 32
- Super vivid **VI** ..... 41
- I**
- Target finding AF... 62, 68, 39
- Thumbnail playback ..... 73
- Time difference ..... 65
- Time zone ..... 18, 64
- Time zone and date  
..... 16, 83, 64
- Toy camera effect 1 1 ..... 42
- Toy camera effect 2 2 ..... 42
- Tripod socket ..... 2, 27
- TV ..... 97, 20
- TV settings ..... 84, 74
- U**
- USB cable ..... 96, 99, 22
- USB connector cover ..... 2
- V**
- Vibration reduction  
..... 80, 83, 61, 69
- View log ..... 92, 85
- ViewNX 2 ..... 98
- Vividness ..... 57
- Voice memo ..... 74, 52
- Volume ..... 81, 52
- W**
- Welcome screen ..... 83, 63
- White balance ..... 62, 31
- Wi-Fi options ..... 93, 89
- Wind noise reduction ... 80, 62
- Wireless LAN ..... 93, 89
- Z**
- Zoom ..... 25
- Zoom control ..... 1, 25
- Zoom in ..... 25
- Zoom out ..... 25



A series of horizontal dashed lines spanning the width of the page, intended for handwriting practice.

No reproduction in any form of this manual, in whole or in part (except for brief quotation in critical articles or reviews), may be made without written authorization from NIKON CORPORATION.

**NIKON CORPORATION**

© 2014 Nikon Corporation



FX4C02(11)  
6MN41311-02