

Nikon

DIGITAL CAMERA

COOLPIX S5300

Reference Manual



En

Introduction	
Parts of the Camera	
The Basics of Shooting and Playback	
Shooting Features	
Playback Features	
Recording and Playing Back Movies	
General Camera Setup	
Using the Wi-Fi (Wireless LAN) Function	
Connecting the Camera to a TV, Computer, or Printer	
Reference Section	
Technical Notes and Index	

Introduction

Read This First

Thank you for purchasing the Nikon COOLPIX S5300 digital camera. Before using the camera, please read the information in "For Your Safety" (📖viii-x) and familiarize yourself with the information provided in this manual. After reading, please keep this manual handy and refer to it to enhance your enjoyment of your new camera.





About This Manual

If you want to start using the camera right away, see “The Basics of Shooting and Playback” (📖10).

To learn about the parts of the camera and information that is displayed in the monitor, see “Parts of the Camera” (📖1).

Other Information

- Symbols and Conventions

Symbol	Description
	This icon marks cautions and information that should be read before using the camera.
	This icon marks notes and information that should be read before using the camera.
	These icons indicate other pages containing relevant information;  : "Reference Section",  : "Technical Notes and Index"

- SD, SDHC, and SDXC memory cards are referred to as "memory cards" in this manual.
- The setting at the time of purchase is referred to as the "default setting."
- The names of menu items displayed in the camera monitor, and the names of buttons or messages displayed on a computer monitor appear in bold.
- In this manual, images are sometimes omitted from monitor display samples so that monitor indicators can be more clearly shown.
- Illustrations and monitor content shown in this manual may differ from the actual product.

Information and Precautions

Life-Long Learning

As part of Nikon's "Life-Long Learning" commitment to ongoing product support and education, continually updated information is available online at the following sites:

- For users in the U.S.A.: <http://www.nikonusa.com/>
- For users in Europe and Africa: <http://www.europe-nikon.com/support/>
- For users in Asia, Oceania, and the Middle East: <http://www.nikon-asia.com/>

Visit these sites to keep up-to-date with the latest product information, tips, answers to frequently asked questions (FAQs), and general advice on digital imaging and photography. Additional information may be available from the Nikon representative in your area. Visit the site below for contact information.

<http://imaging.nikon.com/>

Use Only Nikon Brand Electronic Accessories

Nikon COOLPIX cameras are designed to the highest standards and include complex electronic circuitry. Only Nikon brand electronic accessories (including battery chargers, batteries, Charging AC Adapters, AC adapters and, USB cables) certified by Nikon specifically for use with this Nikon digital camera are engineered and proven to operate within the operational and safety requirements of this electronic circuitry.

THE USE OF NON-NIKON ELECTRONIC ACCESSORIES COULD DAMAGE THE CAMERA AND MAY VOID YOUR NIKON WARRANTY.

The use of third-party rechargeable Li-ion batteries not bearing the Nikon holographic seal could interfere with normal operation of the camera or result in the batteries overheating, igniting, rupturing, or leaking.

For more information about Nikon brand accessories, contact a local authorized Nikon dealer.

Holographic seal: Identifies this device as an authentic Nikon product.



Before Taking Important Images

Before taking images on important occasions (such as at weddings or before taking the camera on a trip), take a test shot to ensure that the camera is functioning normally. Nikon will not be held liable for damages or lost profits that may result from product malfunction.

About the Manuals

- No part of the manuals included with this product may be reproduced, transmitted, transcribed, stored in a retrieval system, or translated into any language in any form, by any means, without Nikon's prior written permission.
- Nikon reserves the right to change the specifications of the hardware and software described in these manuals at any time and without prior notice.
- Nikon will not be held liable for any damages resulting from the use of this product.
- While every effort was made to ensure that the information in these manuals is accurate and complete, we would appreciate it were you to bring any errors or omissions to the attention of the Nikon representative in your area (address provided separately).

Notice Concerning Prohibition of Copying or Reproduction

Note that simply being in possession of material that was digitally copied or reproduced by means of a scanner, digital camera or other device may be punishable by law.

• Items prohibited by law from being copied or reproduced

Do not copy or reproduce paper money, coins, securities, government bonds or local government bonds, even if such copies or reproductions are stamped "Sample." The copying or reproduction of paper money, coins, or securities which are circulated in a foreign country is prohibited. Unless the prior permission of the government was obtained, the copying or reproduction of unused postage stamps or post cards issued by the government is prohibited.

The copying or reproduction of stamps issued by the government and of certified documents stipulated by law is prohibited.

• Cautions on certain copies and reproductions

The government has issued cautions on copies or reproductions of securities issued by private companies (shares, bills, checks, gift certificates, etc.), commuter passes, or coupon tickets, except when a minimum of necessary copies are to be provided for business use by a company. Also, do not copy or reproduce passports issued by the government, licenses issued by public agencies and private groups, ID cards and tickets, such as passes and meal coupons.

• Comply with copyright notices

The copying or reproduction of copyrighted creative works such as books, music, paintings, woodcut prints, maps, drawings, movies, and photographs is governed by national and international copyright laws. Do not use this product for the purpose of making illegal copies or to infringe copyright laws.

Disposing of Data Storage Devices

Please note that deleting images or formatting data storage devices such as memory cards or built-in camera memory does not completely erase the original image data. Deleted files can sometimes be recovered from discarded storage devices using commercially available software, potentially resulting in the malicious use of personal image data. Ensuring the privacy of such data is the user's responsibility.

Before discarding a data storage device or transferring ownership to another person, erase all data using commercial deletion software, or format the device and then completely refill it with images containing no private information (for example, images of empty sky). Be sure to also replace any images selected for the **Select an image** option in the **Welcome screen** setting (📷77). Care should be taken to avoid injury or damage to property when physically destroying data storage devices.

To delete the Wi-Fi settings, select **Restore default settings** in the Wi-Fi options menu (📶71).

For Your Safety

To prevent damage to your Nikon product or injury to yourself or to others, read the following safety precautions in their entirety before using this equipment. Keep these safety instructions where all those who use the product will read them.

The consequences that could result from failure to observe the precautions listed in this section are indicated by the following symbol:



This icon marks warnings, information that should be read before using this Nikon product, to prevent possible injury.

WARNINGS

Turn off in the event of malfunction

Should you notice smoke or an unusual smell coming from the camera or Charging AC Adapter, unplug the Charging AC Adapter and remove the battery immediately, taking care to avoid burns. Continued operation could result in injury. After removing or disconnecting the power source, take the equipment to a Nikon-authorized service representative for inspection.

Do not disassemble

Touching the internal parts of the camera or Charging AC Adapter could result in injury. Repairs should be performed only by qualified technicians. Should the camera or Charging AC Adapter break open as the result of a fall or other accident, take the product to a Nikon-authorized service

representative for inspection, after unplugging the product and/or removing the battery.

Do not use the camera or Charging AC Adapter in the presence of flammable gas

Do not use electronic equipment in the presence of flammable gas, as this could result in explosion or fire.

 **Handle the camera strap with care**
Never place the strap around the neck of an infant or child.

 **Keep out of reach of children**
Particular care should be taken to prevent infants from putting the battery or other small parts into their mouths.

⚠ Do not remain in contact with the camera, Charging AC Adapter, or AC adapter for extended periods while the devices are on or in use

Parts of the devices become hot. Leaving the devices in direct contact with the skin for extended periods may result in low-temperature burns.

⚠ Do not leave the product where it will be exposed to extremely high temperatures, such as in an enclosed automobile or in direct sunlight

Failure to observe this precaution could cause damage or fire.

⚠ Observe caution when handling the battery

The battery may leak, overheat, or explode if improperly handled. Observe the following precautions when handling the battery for use in this product:

- Before replacing the battery, turn the product off. If you are using the Charging AC Adapter/AC adapter, be sure it is unplugged.
- Use only a Rechargeable Li-ion Battery EN-EL19 (included). Charge the battery by using a camera that supports battery charging. To perform this operation, use the Charging AC Adapter EH-71P (included) and USB cable UC-E21 (included). The Battery Charger MH-66 (available separately) is also available to charge the battery without using a camera.

- When inserting the battery, do not attempt to insert it upside down or backwards.
- Do not short or disassemble the battery or attempt to remove or break the battery insulation or casing.
- Do not expose the battery to flame or to excessive heat.
- Do not immerse in or expose to water.
- Put the battery in a plastic bag, etc. in order to insulate it before transporting. Do not transport or store with metal objects such as necklaces or hairpins.
- The battery is prone to leakage when fully discharged. To avoid damage to the product, be sure to remove the battery when no charge remains.
- Discontinue use immediately should you notice any change in the battery, such as discoloration or deformation.
- If liquid from the damaged battery comes in contact with clothing or skin, rinse immediately with plenty of water.

⚠ Observe the following precautions when handling the Charging AC Adapter

- Keep dry. Failure to observe this precaution could result in fire or electric shock.
- Dust on or near the metal parts of the plug should be removed with a dry cloth. Continued use could result in fire.
- Do not handle the plug or go near the Charging AC Adapter during lightning storms. Failure to observe this precaution could result in electric shock.

- Do not damage, modify, forcibly tug or bend the USB cable, place it under heavy objects, or expose it to heat or flames. Should the insulation be damaged and the wires become exposed, take it to a Nikon-authorized service representative for inspection. Failure to observe these precautions could result in fire or electric shock.
- Do not handle the plug or Charging AC Adapter with wet hands. Failure to observe this precaution could result in electric shock.
- Do not use with travel converters or adapters designed to convert from one voltage to another or with DC-to-AC inverters. Failure to observe this precaution could damage the product or cause overheating or fire.

 **Use the appropriate power supply (battery, Charging AC adapter, AC adapter, USB cable)**

Using a power supply other than those provided or sold by Nikon could result in damage or malfunction.

 **Use appropriate cables**

When connecting cables to the input and output jacks, use only the cables provided or sold by Nikon for the purpose, to maintain compliance with product regulations.

 **Handle moving parts with care**

Be careful that your fingers or other objects are not pinched by the lens cover or other moving parts.

 **Using the flash close to your subject's eyes could cause temporary visual impairment**

The flash should be no less than 1 meter (3 ft 4 in.) from the subject.

Particular care should be observed when photographing infants.

 **Do not operate the flash with the flash window touching a person or object**

Failure to observe this precaution could result in burns or fire.

 **Avoid contact with liquid crystal**

Should the monitor break, care should be taken to avoid injury caused by broken glass and to prevent liquid crystal from the monitor touching the skin or entering the eyes or mouth.

 **Turn the power off when using inside an airplane or the hospital**

Turn the power off while inside the airplane during take off or landing. Do not use wireless network functions while in the air. Follow the instructions of the hospital when using while in a hospital. The electromagnetic waves emitted by this camera may disrupt the electronic systems of the airplane or the instruments of the hospital. If you are using an Eye-Fi card, remove it from the camera before boarding an aircraft or entering a hospital.

Notices

Notices for Customers in the U.S.A.

IMPORTANT SAFETY INSTRUCTIONS -

SAVE THESE INSTRUCTIONS.

DANGER - TO REDUCE THE RISK OF FIRE OR ELECTRIC SHOCK, CAREFULLY FOLLOW THESE INSTRUCTIONS

For connection to a supply not in the U.S.A., use an attachment plug adapter of the proper configuration for the power outlet if needed.

The power supply unit is intended to be correctly orientated in a vertical or floor mount position.

Federal Communications Commission (FCC) Radio Frequency Interference Statement

This equipment has been tested and found to comply with the limits for a Class B digital device, pursuant to Part 15 of the FCC rules. These limits are designed to provide reasonable protection against harmful interference in a residential installation. This equipment generates, uses, and can radiate radio frequency energy and, if not installed and used in accordance with the

instructions, may cause harmful interference to radio communications. However, there is no guarantee that interference will not occur in a particular installation. If this equipment does cause harmful interference to radio or television reception, which can be determined by turning the equipment off and on, the user is encouraged to try to correct the interference by one or more of the following measures:

- Reorient or relocate the receiving antenna.
- Increase the separation between the equipment and receiver.
- Connect the equipment into an outlet on a circuit different from that to which the receiver is connected.
- Consult the dealer or an experienced radio/television technician for help.



Nikon

COOLPIX S5300

CAUTIONS

Modifications

The FCC requires the user to be notified that any changes or modifications made to this device that are not expressly approved by Nikon Corporation may void the user's authority to operate the equipment.

Interface Cables

Use the interface cables sold or provided by Nikon for your equipment. Using other interface cables may exceed the limits of Class B Part 15 of the FCC rules.

Notice for Customers in the State of California

WARNING

Handling the cord on this product will expose you to lead, a chemical known to the State of California to cause birth defects or other reproductive harm.

Wash hands after handling.

Nikon Inc.,
1300 Walt Whitman Road
Melville, New York 11747-3064
USA
Tel: 631-547-4200

Notice for Customers in Canada

CAN ICES-3 B / NMB-3 B

Notices for Customers in Europe

CAUTIONS

RISK OF EXPLOSION IF BATTERY IS REPLACED BY AN INCORRECT TYPE.

DISPOSE OF USED BATTERIES ACCORDING TO THE INSTRUCTIONS.

This symbol indicates that electrical and electronic equipment is to be collected separately.



The following apply only to users in European countries:

- This product is designated for separate collection at an appropriate collection point. Do not dispose of as household waste.
- Separate collection and recycling helps conserve natural resources and prevent negative consequences for human health and the environment that might result from incorrect disposal.
- For more information, contact the retailer or the local authorities in charge of waste management.

This symbol on the battery indicates that the battery is to be collected separately.



The following apply only to users in European countries:

- All batteries, whether marked with this symbol or not, are designated for separate collection at an appropriate collection point. Do not dispose of as household waste.
- For more information, contact the retailer or the local authorities in charge of waste management.

Wi-Fi (Wireless LAN Network)

This product is controlled by the United States Export Administration Regulations, and you are required to obtain permission from the United States government if you export or re-export this product to any country to which the United States embargoes goods. The following countries were subject to embargo: Cuba, Iran, North Korea, Sudan, and Syria. Since the target countries are subject to change, please contact the United States Department of Commerce for the latest information.

Restrictions on Wireless Devices

The wireless transceiver included in this product conforms to wireless regulations in the country of sale and is not for use in other countries (products purchased in the EU or EFTA can be used anywhere within the EU and EFTA). Nikon does not accept liability for use in other countries. Users who are unsure as to the original country of sale should consult with their local Nikon service center or Nikon-authorized service representative. This restriction applies to wireless operation only and not to any other use of the product.

Notice for Customers in the U.S.A. and Canada

Federal Communications Commission (FCC) and Industry of Canada (IC)

Declaration of Conformity

This device complies with Part 15 of FCC Rules and Industry Canada licence-exempt RSS standard(s). Operation is subject to the following two conditions: (1) this device may not cause interference, and (2) this device must accept any interference, including interference that may cause undesired operation of this device.

FCC/IC RF Exposure Statement

This transmitter must not be co-located or operated in conjunction with any other antenna or transmitter.

The available scientific evidence does not show that any health problems are associated with using low power wireless devices. There is no proof, however, that these low power wireless devices are absolutely safe. Low power wireless devices emit low levels of radio frequency energy (RF) in the microwave range while being used. Whereas high levels of RF can produce health effects (by heating tissue), exposure of low-level RF that does not produce heating effects causes no known adverse health effects. Many studies of low-level RF exposures have not found any biological effects. Some studies have suggested that some biological effects might occur, but such findings have not been confirmed by additional research.

COOLPIX S5300, which is equipped with a WSDB-686GN (FCC ID:2AAD3AA1G0J0 / IC ID:4634A-2150EC) Wireless LAN Module, has been tested and found to comply with FCC/IC radiation exposure limits set forth for an uncontrolled environment and meets the FCC radio frequency (RF) Exposure Guidelines in Supplement C to OET65 and RSS-102 of the IC radio frequency (RF) Exposure rules. Please refer to the SAR test report that was uploaded to FCC website.

Declaration of Conformity (Europe)

Hereby, Nikon Corporation, declares that COOLPIX S5300 is in compliance with the essential requirements and other relevant provisions of Directive 1999/5/EC. The declaration of conformity may be consulted at http://imaging.nikon.com/support/pdf/DoC_S5300.pdf.

Precautions when Using Radio Transmissions















- Always keep in mind that radio transmission or reception of data is subject to interception by third parties. Note that Nikon is not responsible for data or information leaks that may occur during data transfer.

























Personal Information Management and Disclaimer

- User information registered and configured on the product, including wireless LAN connection settings and other personal information, is susceptible to alteration and loss resulting from operational error, static electricity, accident, malfunction, repair or other handling. Always keep separate copies of important information. Nikon is not responsible for any direct or indirect damages or lost profits resulting from alteration or loss of content that is not attributable to Nikon.
- Before discarding this product or transferring it to another owner, perform **Reset all** in the setup menu (P.77) to delete all user information registered and configured with the product, including wireless LAN connection settings and other personal information.

Table of Contents

Introduction	ii
Read This First	ii
About This Manual	iii
Information and Precautions	v
For Your Safety	viii
WARNINGS	viii
Notices	xi
Wi-Fi (Wireless LAN Network)	xiii
<hr/>	
Parts of the Camera	1
The Camera Body	1
Attaching the Camera Strap	3
Using Menus (the MENU Button)	4
The Monitor	6
Shooting Mode	6
Playback Mode	8
<hr/>	
The Basics of Shooting and Playback	10
Preparation 1 Insert the Battery	10
Preparation 2 Charge the Battery	12
Preparation 3 Insert a Memory Card	14
Internal Memory and Memory Cards	15
Preparation 4 Setting the Display Language, Date, and Time	16
Step 1 Turn the Camera On	20
Step 2 Select a Shooting Mode	22
Available Shooting Modes	23
Step 3 Frame a Picture	24
Using the Zoom	25
Step 4 Focus and Shoot	26
The Shutter-release Button	27
Step 5 Play Back Images	28
Step 6 Delete Images	30
<hr/>	
Shooting Features	32
<i>SCN</i> (Scene Auto Selector) Mode	32
Scene Mode (Shooting Suited to Scenes)	34
Tips and Notes	35
Special Effects Mode (Applying Effects When Shooting)	40
Smart Portrait Mode (Capturing Images of Smiling Faces)	42
<i>Q</i> (Auto) Mode	44
Using Quick Effects	45
Functions That Can Be Set Using the Multi Selector	46
Using the Flash	47
Using the Self-timer	49
Using Macro Mode	51
Adjusting Brightness (Exposure Compensation)	52
Default Settings	53
Functions That Can Be Set with the MENU Button (Shooting Menu)	55

Options Available in the Shooting Menu	76	Take Photos.....	79
Functions That Cannot Be Used		View Photos	79
Simultaneously	58	Installing the Software on the Smart Device	
Focusing	61	Connecting the Smart Device to the Camera	81
Using Face Detection	61		
Using Skin Softening.....	62	Connecting the Camera to a TV, Computer, or Printer	83
Using Target Finding AF	63	Connection Methods	83
Subjects Not Suitable for Autofocus	64	Using ViewNX 2	85
Focus Lock.....	65	Installing ViewNX 2.....	85
		Transferring Images to the Computer.....	86
Playback Features	66	Viewing Images	89
Playback Zoom	66		
Thumbnail Playback/Calendar Display	67	Reference Section	 1
Functions That Can Be Set with the MENU Button (Playback Menu)	68	Using Easy Panorama (Shooting and Playback)	 2
		Shooting with Easy Panorama	 2
Recording and Playing Back Movies	70	Viewing Images Captured with Easy Panorama	 5
Recording Movies	70	Favorite Pictures Mode	 6
Functions That Can Be Set with the MENU Button (Movie Menu)	74	Adding Images to Albums.....	 6
Playing Back Movies	75	Playing Back Images in Albums.....	 7
		Removing Images from Albums	 8
General Camera Setup	77	Changing the Favorites Album Icon	 9
Functions That Can Be Set with the MENU Button (Setup Menu)	77	Auto Sort Mode	 10
		List by Date Mode	 11
Using the Wi-Fi (Wireless LAN) Function	79	Viewing and Deleting Images Captured Continuously (Sequence)	 12
Functions That Can Be Performed Using Wi- Fi.....	79	Viewing Images in a Sequence.....	 12
		Deleting Images in a Sequence	 13

Editing Images (Still Images)		14
Before Editing Images		14
Quick Effects: Changing Hue or Mood		
.....		14
Quick Retouch: Enhancing Contrast and Saturation.....		16
D-Lighting: Enhancing Brightness and Contrast.....		16
Red-eye Correction: Correcting Red-eye When Shooting with the Flash.....		17
Glamour Retouch: Enhancing Human Faces		18
Small Picture: Reducing the Size of an Image.....		20
Crop: Creating a Cropped Copy		21
Connecting the Camera to a TV (Playback on a TV)		22
Connecting the Camera to a Printer (Direct Print)		24
Connecting the Camera to a Printer		25
Printing Images One at a Time.....		27
Printing Multiple Images.....		29
Editing Movies		32
The Shooting Menu (for  (Auto) Mode)		34
Image Mode (Image Size and Quality)		34
White Balance (Adjusting Hue)		36
Continuous Shooting		39
ISO Sensitivity		42
Color Options		43
AF Area Mode.....		44
Autofocus Mode		48
Quick Effects		48
The Smart Portrait Menu		49
Skin Softening.....		49
Smile Timer.....		50
Blink Proof.....		51
The Playback Menu		52
Print Order (Creating a DPOF Print Order)		52
Slide Show		56
Protect		57
Rotate Image.....		59
Voice Memo.....		60
Copy (Copy Between Internal Memory and Memory Card).....		61
Sequence Display Options		63
Choose Key Picture		63
The Movie Menu		64
Movie Options.....		64
Open with HS Footage		68
Autofocus Mode		68
Movie VR		69
Wind Noise Reduction		70
Frame Rate.....		70
The Wi-Fi Options Menu		71
The Setup Menu		73
Welcome Screen.....		73
Time Zone and Date.....		74
Monitor Settings		76
Print Date (Imprinting Date and Time)		78
Photo VR.....		79
Motion Detection.....		80

AF Assist	081
Digital Zoom	081
Sound Settings	082
Auto Off	082
Format Memory/Format Card	083
Language	084
TV Settings	084
Charge by Computer	085
Blink Warning	086
Eye-Fi Upload	087
Reset All	088
Firmware Version	088
Error Messages	089
File Names	094
Optional Accessories	095
<hr/>	
Technical Notes and Index	1
Caring for the Product	2
The Camera	2
The Battery	3
Charging AC Adapter	4
Memory Cards	5
Cleaning and Storage	6
Cleaning	6
Storage	6
Troubleshooting	7
Specifications	17
Approved Memory Cards	22
Index	25



A series of ten horizontal dashed lines spanning the width of the page, intended for handwriting practice.

Parts of the Camera

The Camera Body

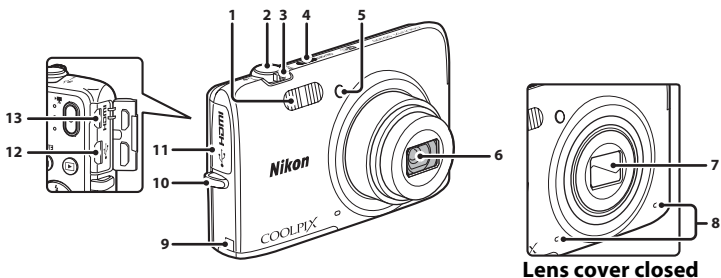

1	Flash.....	47
2	Shutter-release button.....	26
3	Zoom control.....	25
	W : Wide-angle.....	25
	T : Telephoto.....	25
	: Thumbnail playback.....	67
	Q : Playback zoom.....	66
	: Help.....	34
4	Power switch/power-on lamp.....	20
5	Self-timer lamp.....	50
	AF-assist illuminator.....	78

6	Lens.....	
7	Lens cover.....	2
8	Microphone (stereo).....	60
9	Power connector cover (for connection with optional AC adapter).....	
10	Eyelet for camera strap.....	3
11	Connector cover.....	83
12	Micro-USB connector.....	83
13	HDMI micro connector (Type D).....	83

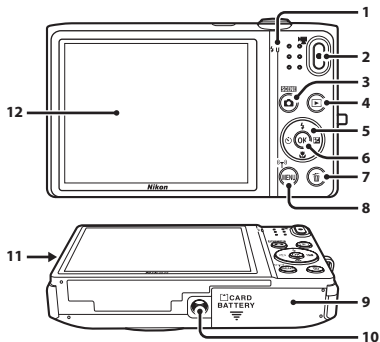

1	Charge lamp.....	13
	Flash lamp.....	47
2	● (movie-record) button.....	70
3	📷 (shooting mode) button	22, 34, 40, 42, 44
4	▶ (playback) button.....	28
5	Multi selector.....	4
6	OK (apply selection) button	4

7	🗑️ (delete) button.....	30, 76, 61
8	MENU (menu) button	4, 55, 68, 74, 77, 81
9	Battery-chamber/ memory card slot cover.....	10, 14
10	Tripod socket.....	19
11	Speaker	
12	Monitor.....	6

Attaching the Camera Strap

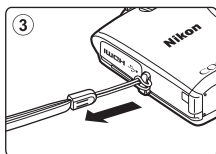
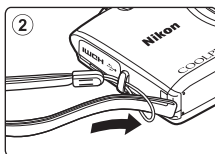
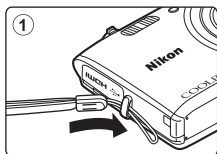

Using Menus (the MENU Button)

Use the multi selector and the **OK** button to navigate the menus.

1 Press the MENU button.

- The menu is displayed.

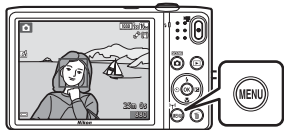

2 Press the multi selector ◀.

- The current menu icon is displayed in yellow.



Menu icons

3 Select the desired menu icon.

- The menu is changed.

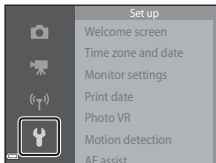

4 Press the OK button.

- The menu options become selectable.

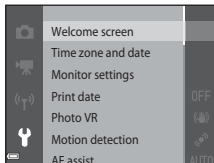

5 Select a menu option.

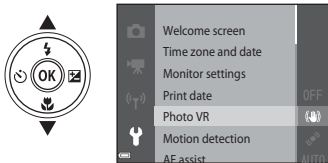

6 Press the **OK** button.

- The settings for the option you selected are displayed.



7 Select a setting.

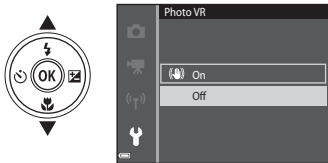



8 Press the **OK** button.

- The setting you selected is applied.
- When you are finished using the menu, press the **MENU** button.



Setting Menu Options

- Certain menu options cannot be set depending on the current shooting mode or the state of the camera. Unavailable options are displayed in gray and cannot be selected.
- When a menu is displayed, you can switch to shooting mode by pressing the shutter-release button,  (shooting mode) button, or  (movie-record) button.









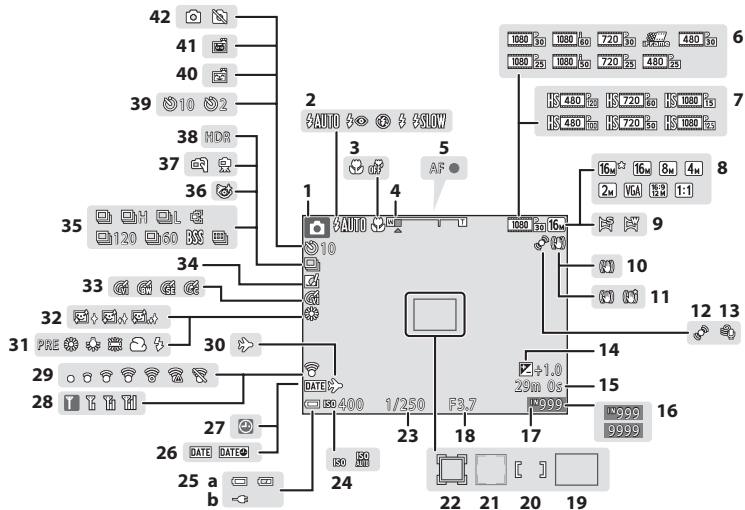















The Monitor

The information that is displayed in the monitor during shooting and playback changes depending on the camera's settings and state of use.

By default, information is displayed when the camera is turned on and when you operate the camera, and turns off after a few seconds (when **Photo info** is set to **Auto info** in **Monitor settings** (📖77)).









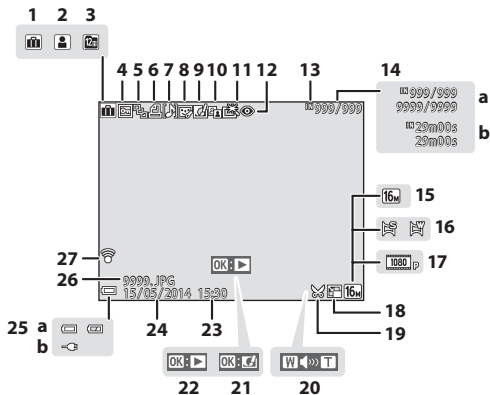











Shooting Mode



1	Shooting mode.....	22, 34, 40, 42, 44
2	Flash mode.....	47
3	Macro mode.....	51
4	Zoom indicator.....	25, 51
5	Focus indicator.....	26
6	Movie options (normal speed movies)	74,  64
7	Movie options (HS movies).....	74,  65
8	Image mode.....	56,  34
9	Easy panorama.....	38,  2
10	Photo VR icon.....	77,  79
11	Movie VR icon.....	74,  69
12	Motion detection icon.....	77,  80
13	Wind noise reduction.....	74,  70
14	Exposure compensation value.....	52
15	Movie recording time remaining.....	70
16	Number of exposures remaining (still images).....	20
17	Internal memory indicator.....	20
18	Aperture value.....	27
19	Focus area (target finding AF).....	63,  46
20	Focus area (for manual or center)	65,  45
21	Focus area (face detection, pet detection).....	26, 39, 42, 61,  44
22	Focus area (subject tracking)	 45,  47
23	Shutter speed.....	27
24	ISO sensitivity.....	56,  42
25	(a) Battery level indicator.....	20
	(b) Charging AC Adapter connection indicator.....	
26	Print date.....	77,  78
27	“Date not set” indicator.....	16
28	Wi-Fi communication indicator	81,  71
29	Eye-Fi communication indicator	78,  87
30	Travel destination icon.....	 74
31	White balance mode.....	56,  36
32	Skin softening.....	57,  49
33	Color options.....	56,  43
34	Quick effects icon.....	45, 56,  48
35	Continuous shooting mode.....	56,  39
36	Blink proof icon.....	57,  51
37	Hand-held/tripod.....	35, 36
38	Backlighting (HDR).....	37
39	Self-timer indicator.....	49
40	Smile timer.....	57,  50
41	Pet portrait auto release.....	39
42	Still image capture (during movie recording).....	73

Playback Mode



1	Album icon in favorite pictures mode  6	15	Image mode..... 56,  34
2	Category icon in auto sort mode  10	16	Easy panorama 38,  5
3	List by date icon  11	17	Movie options 74,  64
4	Protect icon 68,  57	18	Small picture icon 68,  20
5	Sequence display (when Individual pictures is selected) 69,  63	19	Crop icon..... 66,  21
6	Print order icon 68,  52	20	Volume indicator..... 75,  60
7	Voice memo indicator 68,  60	21	Quick effects guide
8	Glamour retouch icon 68,  18		Easy panorama playback guide
9	Quick effects icon 29,  14	22	Sequence playback guide
10	D-Lighting icon 68,  16		Movie playback guide
11	Quick retouch icon..... 68,  16	23	Time of recording
12	Red-eye correction icon 68,  17	24	Date of recording
13	Internal memory indicator		(a) Battery level indicator 20
	(a) Current image number/ total number of images	25	(b) Charging AC Adapter connection indicator
14	(b) Movie length	26	File number and type.....  94
		27	Eye-Fi communication indicator 78,  87

The Basics of Shooting and Playback

Preparation 1 Insert the Battery

- 1 Open the battery-chamber/memory card slot cover.

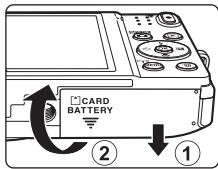

- 2 Insert the battery.

- Push the orange battery latch in the direction indicated by the arrow (1), and fully insert the battery (2).
- The battery locks into place when inserted correctly.

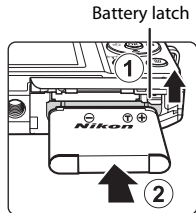

- ✓ Be Careful to Insert the Battery in Correct Direction**

Inserting the battery upside down or backwards could damage the camera.



- 3** Close the battery-chamber/memory card slot cover.

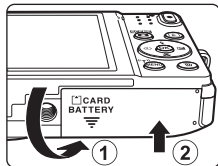

Removing the Battery

Turn the camera off and make sure that the power-on lamp and monitor have turned off, and then open the battery-chamber/memory card slot cover.

Move the battery latch in the direction indicated by the arrow (①) to eject the battery (②).

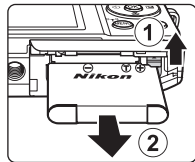

High Temperature Caution

The camera, battery, and memory card may be hot immediately after using the camera.

Preparation 2 Charge the Battery

1 Prepare the included Charging AC Adapter.

If a plug adapter* is included with your camera, attach the plug adapter to the Charging AC Adapter. Push the plug adapter firmly until it is securely held in place. Once the two are connected, attempting to forcibly remove the plug adapter could damage the product.

* The shape of the plug adapter varies according to the country or region in which the camera was purchased. This step can be omitted if the plug adapter comes permanently bonded to the Charging AC Adapter.

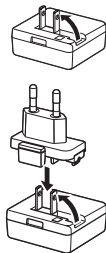

2 Make sure the battery is installed in the camera, and then connect the camera to the Charging AC Adapter in order of ① to ③.

- Make sure that the plugs are properly oriented. Do not insert or remove the plugs at an angle when connecting or disconnecting them.

Note

Do not use a USB cable other than the UC-E21. Using a USB cable other than the UC-E21 could result in overheating, fire or electric shock.

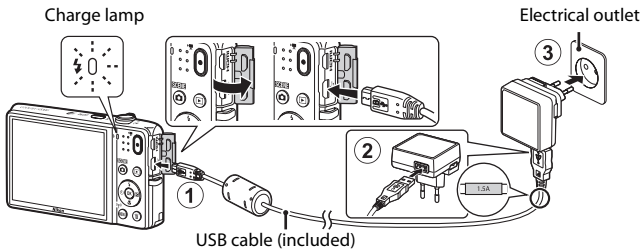

- The charge lamp slowly flashes green to indicate that the battery is charging.



Charge lamp	Description
Flashes slowly (green)	The battery is charging.
Off	When charging is complete, the charge lamp stops flashing green and turns off. About 1 hour and 50 minutes are required to charge a fully exhausted battery.
Flashes quickly (green)	<ul style="list-style-type: none"> • The ambient temperature is not suited to charging. Charge the battery indoors with an ambient temperature of 5°C to 35°C (41°F to 95°F). • The USB cable or Charging AC Adapter is not properly connected, or there is a problem with the battery. Disconnect the USB cable or unplug the Charging AC Adapter and correctly connect it again, or change the battery.

3 Disconnect the Charging AC Adapter from the electrical outlet and then disconnect the USB cable.

Notes About Charging the Battery

- The camera can be operated while the battery is charging, but the charging time increases.
- If the battery level is extremely low, you may not be able to operate the camera while the battery is charging.
- Do not, under any circumstances, use another make or model of AC adapter other than Charging AC Adapter EH-71P, and do not use a commercially available USB-AC adapter or a battery charger for a mobile phone. Failure to observe this precaution could result in overheating or in damage to the camera.

Charging Using a Computer or Battery Charger

- You can also charge the battery by connecting the camera to a computer (83, 85).
- You can use the Battery Charger MH-66 (available separately; 95) to charge the battery without using the camera.

Preparation 3 Insert a Memory Card

- 1 Turn off the camera and open the battery-chamber/memory card slot cover.

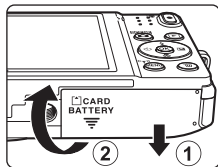

- 2 Insert the memory card.
 - Slide the memory card in until it clicks into place.

Memory card slot

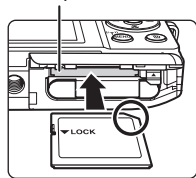

- Be Careful to Insert the Memory Card in Correct Direction**

Inserting the memory card upside down or backwards could damage the camera and memory card.



- 3 Close the battery-chamber/memory card slot cover.

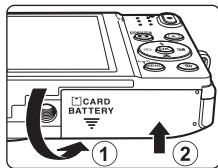

✓ Formatting a Memory Card

The first time you insert a memory card that has been used in another device into this camera, make sure to format it with this camera. Insert the memory card into the camera, press the **MENU** button, and select **Format card** in the setup menu.

Removing the Memory Card

Turn the camera off and make sure that the power-on lamp and monitor have turned off, and then open the battery-chamber/memory card slot cover.

Gently push the memory card into the camera (①) to partially eject the card (②).

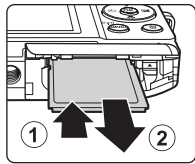

✓ High Temperature Caution

The camera, battery, and memory card may be hot immediately after using the camera.

Internal Memory and Memory Cards

Camera data, including images and movies, can be saved either in the camera's internal memory or on a memory card. To use the camera's internal memory, first remove the memory card.



Preparation 4 Setting the Display Language, Date, and Time

When the camera is turned on for the first time, the language-selection screen and the date and time setting screen for the camera clock are displayed.

- If you exit without setting the date and time,  will flash when the shooting screen is displayed.

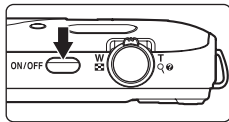
- 1 Press the power switch to turn on the camera.



- 2 Use the multi selector   to select the desired language and press the  button.

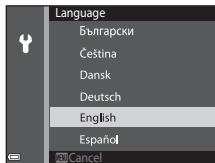

- 3 Select **Yes** and press the  button.

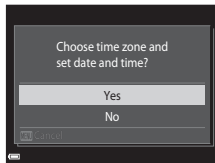

4 Select your home time zone and press the **OK** button.

- To enable daylight saving time, press ▲. When the daylight saving time function is enabled, ☀ is displayed above the map. To disable the daylight saving time function, press ▼.

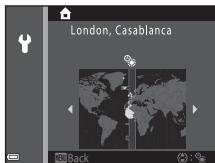

5 Select the date format and press the **OK** button.

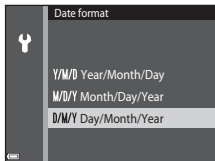

6 Set the date and time, and press the **OK** button.

- Select a field: Press ◀▶ (changes between **D**, **M**, **Y**, hour, and minute).
- Edit the date and time: Press ▲▼.
- Confirm the settings: Select the minute field and press the **OK** button.

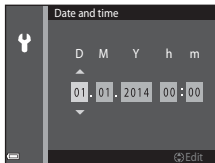

7 Select **Yes** and press the **OK** button.

- When settings are finished, the lens extends and the camera switches to shooting mode.

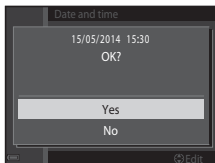

Changing the Language or the Date and Time Setting

- You can change these settings using the **Language** and **Time zone and date** settings in the **Y** setup menu (📖77).
- You can enable or disable daylight saving time in the **Y** setup menu by selecting **Time zone and date** followed by **Time zone**. Press the multi selector **▶** and then **▲** to enable daylight saving time and move the clock forward one hour, or **▼** to disable daylight saving time and move the clock back one hour.

The Clock Battery

- The camera's clock is powered by a built-in backup battery. The backup battery charges when the main battery is inserted into the camera or when the camera is connected to an optional AC adapter, and it can run the clock for several days after about ten hours of charging.
- If the camera's backup battery becomes exhausted, the date and time setting screen is displayed when the camera is turned on. Set the date and time again. See step 3 (📖16) of "Preparation 4 Setting the Display Language, Date, and Time" for more information.

Imprinting the Shooting Date on Printed Images

- You can permanently imprint the shooting date on images as they are captured by setting **Print date** in the setup menu (📖77).
- You can use the ViewNX 2 software (📖85) to print the shooting date on images that were captured without using the **Print date** option.



A series of ten horizontal dashed lines spanning the width of the page, intended for handwriting practice.

Step 1 Turn the Camera On

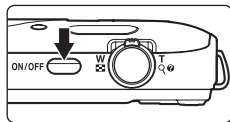

1 Press the power switch.

- The monitor turns on.
- To turn the camera off, press the power switch again.



2 Check the battery level indicator and the number of exposures remaining.

Battery Level Indicator

Display	Description
	The battery level is high.
	The battery level is low.
 Battery exhausted.	The camera cannot capture images. Recharge the battery.

Number of exposures remaining



Battery level indicator



Number of Exposures Remaining

The number of images that can be taken is displayed.

-  is displayed when no memory card is inserted in the camera, and images are saved in the internal memory.

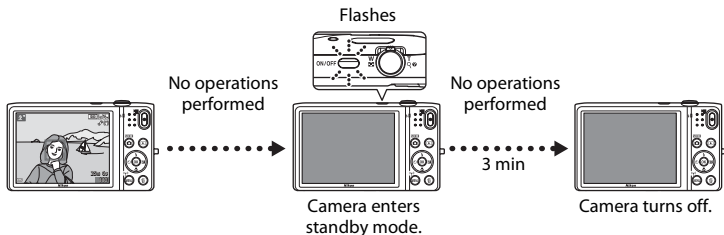
The Auto Off Function







- The time that elapses before the camera enters standby mode is about one minute. The time can be changed using the **Auto off** setting in the setup menu (p.77).
- While the camera is in standby mode, the monitor turns back on if you perform any of the following operations:
 - Press the power switch, shutter-release button,  (shooting mode) button,  (playback) button, or  movie-record button.

Step 2 Select a Shooting Mode

- 1 Press the  button.







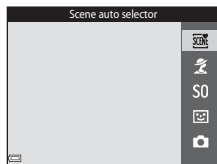



- 2 Use the multi selector   to select a shooting mode and press the  button.

-  (scene auto selector) mode is used in this example.
- The shooting mode setting is saved even after the camera is turned off.



Available Shooting Modes

	Scene auto selector  32
	The camera automatically selects the optimum scene mode when you frame an image, making it even easier to take images using settings that suit the scene.
	Scene mode  34
	Camera settings are optimized according to the scene that you select.
S0	Special effects  40
	Effects can be applied to images during shooting.
	Smart portrait  42
	When the camera detects a smiling face, you can take an image automatically without pressing the shutter-release button (smile timer). You can also use the skin softening option to smooth the skin tones of human faces.
	Auto mode  44
	Used for general shooting. Settings can be adjusted to suit the shooting conditions and the type of shot you want to capture.

Step 3 Frame a Picture

1 Hold the camera steady.

- Keep fingers and other objects away from the lens, flash, AF assist-illuminator, microphone, and speaker.
- When taking pictures in portrait (“tall”) orientation, turn the camera so that the flash is above the lens.

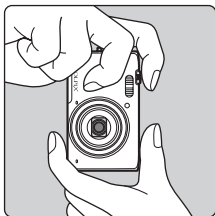
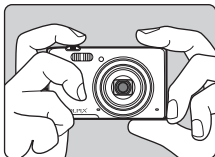

2 Frame the picture.

- When the camera automatically determines the scene mode, the shooting mode icon changes (📖32).

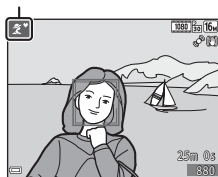

Shooting mode icon



✓ Notes About **SCN** (Scene Auto Selector) Mode

- Depending upon shooting conditions, the camera may not select the desired scene mode. In this case, select another shooting mode (📖34, 40, 42, 44).
- When the digital zoom is in effect, the scene mode changes to **DMF**.

When Using a Tripod

- We recommend using a tripod to stabilize the camera in the following situations:
 - When shooting in dim lighting
 - When shooting with the flash mode () set to  (off)
 - When using the telephoto setting
- When using a tripod to stabilize the camera during shooting, set **Photo VR** to **Off** in the setup menu () to prevent potential errors caused by this function.

Using the Zoom

When you move the zoom control, the zoom lens position changes.

- To zoom in closer to the subject: Move toward **T** (telephoto).
- To zoom out and view a larger area: Move toward **W** (wide-angle).

When you turn the camera on, the zoom moves to the maximum wide-angle position.

- A zoom indicator is displayed at the top of the monitor when the zoom control is moved.
- Digital zoom, which allows you to further magnify the subject up to approximately 4x the maximum optical zoom ratio, can be activated by moving and holding the zoom control toward **T** when the camera is zoomed in to the maximum optical zoom position.

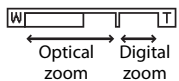
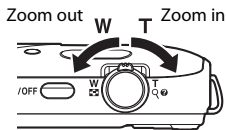

Notes About Digital Zoom

The zoom indicator turns blue when the digital zoom is activated, and it turns yellow when the zoom magnification is increased further.

- Zoom indicator is blue: Image quality is not noticeably reduced by using the Dynamic Fine Zoom.
- Zoom indicator is yellow: Image quality is noticeably reduced.
- The indicator remains blue across a wider area when the image size is smaller.
- The zoom indicator may not turn blue when using certain continuous shooting settings.

Step 4 Focus and Shoot

1 Press the shutter-release button halfway.

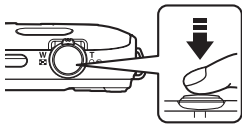

- When the subject is in focus, the focus area glows green (multiple focus areas can glow green).
- When you are using digital zoom, the camera focuses in the center of the frame and the focus area is not displayed. When the camera has focused, the focus indicator (L7) glows green.
- If the focus area or focus indicator flashes, the camera is unable to focus. Modify the composition and try pressing the shutter-release button halfway again.



2 Without lifting your finger, press the shutter-release button the rest of the way down.



The Shutter-release Button

<p>Press halfway</p> 	<p>To set focus and exposure (shutter speed and aperture value), press the shutter-release button lightly until you feel a slight resistance. Focus and exposure remain locked while the shutter-release button is pressed halfway.</p>
<p>Press all the way</p> 	<p>Press the shutter-release button all the way to release the shutter and take an image. Do not use force when pressing the shutter-release button, as this may result in camera shake and blurred images. Press the button gently.</p>

Notes About Saving Images and Recording Movies

The indicator showing the number of exposures remaining or the indicator showing the maximum movie length flashes while images are being saved or while a movie is being recorded. **Do not open the battery-chamber/memory card slot cover or remove the battery or memory card** while an indicator is flashing. Doing this could result in loss of data, or in damage to the camera or the memory card.

Step 5 Play Back Images

1 Press the (playback) button.

- If you press and hold down the  (playback) button while the camera is turned off, the camera turns on in playback mode.



2 Use the multi selector to select an image to display.

- Press and hold down     to scroll through the images quickly.

Display the previous image





Display the next image

- To return to shooting mode, press the  button or shutter-release button.



The Quick Effects Function



- When **OK**:  is displayed in full-frame playback mode, you can press the **OK** button to apply an effect to the image.
- When the effect selection screen is displayed, use the multi selector  to select an effect, press the **OK** button, and then select **Yes** in the confirmation dialog and press the **OK** button to save the image as a separate file.
See "Quick Effects: Changing Hue or Mood" (14) for more information.



Step 6 Delete Images

- 1 Press the  button to delete the image currently displayed in the monitor.



- 2 Use the multi selector   to select the desired deletion method and press the  button.

- To exit without deleting, press the **MENU** button.

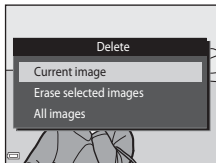

- 3 Select **Yes** and press the  button.

- Deleted images cannot be recovered.
- To cancel, select **No** and press the  button.

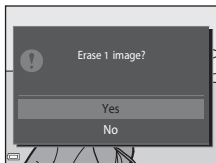

Operating the Erase Selected Images Screen

1 Use the multi selector ◀▶ to select an image to be deleted, and then use ▲ to display 🗑️.

- To undo the selection, press ▼ to remove 🗑️.
- Move the zoom control (📄1) toward **T** (🔍) to switch to full-frame playback or **W** (🖼️) to switch to thumbnail playback.



2 Add 🗑️ to all images that you want to delete and then press the **OK** button to confirm the selection.

- A confirmation dialog is displayed. Follow the on-screen instructions to complete operations.

✔ **Deleting Images in a Sequence**

- If you press the 🗑️ button and delete a key picture while only key pictures are displayed for sequences of images (📖69), all images in the sequence, including the key picture, are deleted.
- To delete individual images in a sequence, press the **OK** button to display them one at a time and press the 🗑️ button.



✍ **Deleting the Last Image Captured While in Shooting Mode**

When using shooting mode, press the 🗑️ button to delete the last image that was saved.











Shooting Features

(Scene Auto Selector) Mode



The camera automatically selects the optimum scene mode when you frame an image, making it even easier to take images using settings that suit the scene.

Enter shooting mode →  (shooting mode) button →  (scene auto selector) mode →  button

When the camera selects a scene mode, the shooting mode icon displayed in the shooting screen changes to that for the scene mode currently enabled.







	Portrait (for taking close-up portraits of one or two people)
	Portrait (for taking portraits of three or more people, or images in which a large background takes up the frame)
	Landscape
	Night portrait (for taking close-up portraits of one or two people)
	Night portrait (for taking portraits of three or more people, or images in which a large background takes up the frame)
	Night landscape
	Close-up
	Backlighting (for taking images of subjects other than people)
	Backlighting (for taking portrait images)
	Other scenes

Functions Available in (Scene Auto Selector) Mode



















- Flash mode ( 47)
- Self-timer ( 49)
- Exposure compensation ( 52)

Scene Mode (Shooting Suited to Scenes)

When a scene is selected, camera settings are automatically optimized for the selected scene.

Enter shooting mode →  (shooting mode) button →  (second icon from the top*)
→     → select a scene →  button

* The icon of the last scene selected is displayed.

 Portrait (default setting)	 Landscape ¹	 Sports ² (📖35)	 Night portrait (📖35)
 Party/indoor ² (📖35)	 Beach ²	 Snow ²	 Sunset ^{2,3}
 Dusk/dawn ^{1,3}	 Night landscape ¹ (📖36)	 Close-up (📖36)	 Food (📖36)
 Museum ² (📖37)	 Fireworks show ^{1,3} (📖37)	 Black and white copy ² (📖37)	 Backlighting ² (📖37)
 Easy panorama (📖38)	 Pet portrait (📖39)		

¹ The camera focuses at infinity.

² The camera focuses on the area in the center of the frame.

³ Use of a tripod is recommended, because the shutter speed is slow. Set **Photo VR** to **Off** in the setup menu (📖77) when using a tripod to stabilize the camera during shooting.

Displaying a Description of Each Scene Mode (Help Display)

Select a scene and move the zoom control (📖1) toward **T** (🔍) to view a description of that scene. To return to the original screen, move the zoom control toward **T** (🔍) again.

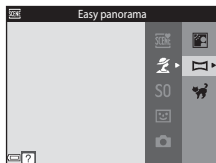







Tips and Notes

Sports

- While the shutter-release button is held all the way down, the camera shoots up to about 7 images continuously at a rate of about 2 fps (when image mode is set to **16M**).
- The frame rate for continuous shooting may vary depending on the current image mode setting, the memory card used, or shooting conditions.
- Focus, exposure, and hue are fixed at the values determined with the first image in each series.







Night portrait

- From the screen displayed after  **Night portrait** is selected, select  **Hand-held** or  **Tripod**.
-  **Hand-held** (default setting):
 - When the  icon at the top left of the monitor glows green, press the shutter-release button all the way to capture a series of images which are combined into a single image and saved.
 - Once the shutter-release button is pressed all the way, hold the camera still until a still image is displayed. After taking an image, do not turn the camera off before the monitor switches to the shooting screen.
 - If the subject moves while the camera is shooting continuously, the image may be distorted, overlapped, or blurred.
-  **Tripod**:
 - One image is captured at a slow shutter speed when the shutter-release button is pressed all the way.
 - Vibration reduction is disabled even when **Photo VR** in the setup menu () is set to **On**.



Party/indoor

- To avoid the effects of camera shake, hold the camera steady. Set **Photo VR** to **Off** in the setup menu () when using a tripod to stabilize the camera during shooting.





Night landscape

- From the screen displayed after  **Night landscape** is selected, select  **Hand-held** or  **Tripod**.
-  **Hand-held** (default setting):
 - When the  icon at the top left of the monitor glows green, press the shutter-release button all the way to capture a series of images which are combined into a single image and saved.
 - Once the shutter-release button is pressed all the way, hold the camera still until a still image is displayed. After taking an image, do not turn the camera off before the monitor switches to the shooting screen.
 - The angle of view (i.e., the area visible in the frame) seen in the saved image is narrower than that seen in the monitor at the time of shooting.
-  **Tripod**:
 - One image is captured at a slow shutter speed when the shutter-release button is pressed all the way.
 - Vibration reduction is disabled even when **Photo VR** in the setup menu (📖77) is set to **On**.

Close-up

- Macro mode (📖51) is enabled and the camera automatically zooms to the closest position at which it can focus.
- You can move the focus area. Press the  button, use the multi selector  to move the focus area, and press the  button to apply the setting.

Food

- Macro mode (📖51) is enabled and the camera automatically zooms to the closest position at which it can focus.
- You can adjust hue by using the multi selector . The hue setting is saved in the camera's memory even after the camera is turned off.
- You can move the focus area. Press the  button, use the multi selector  to move the focus area, and press the  button to apply the setting.

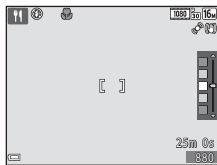

Museum

- The camera captures a series of up to ten images while the shutter-release button is held all the way down, and the sharpest image in the series is automatically selected and saved (BSS (Best Shot Selector)).
- The flash does not fire.



Fireworks show

- The shutter speed is fixed at four seconds.
- The zoom is restricted to four fixed positions.





Black and white copy

- Use together with macro mode (51) when shooting subjects that are close to the camera.

Backlighting

- From the screen displayed after  **Backlighting** is selected, select **ON** or **OFF** to enable or disable the high dynamic range (HDR) function based on the type of image you want to take.
- **OFF** (default setting): The flash fires to prevent the subject from being hidden in shadow.
 - When the shutter-release button is pressed all the way down, one image is captured.
- **ON**: Use when taking images with very bright and dark areas in the same frame.
 - When the shutter-release button is pressed all the way, the camera shoots images continuously at high speed, and saves the following two images.
 - A non-HDR composite image
 - An HDR composite image in which the loss of details in highlights or shadows is minimized
 - If there is only enough memory to save one image, an image processed by D-Lighting (68) at the time of shooting, in which dark areas of the image are corrected, is the only image saved.
 - Once the shutter-release button is pressed all the way, hold the camera still until a still image is displayed. After taking an image, do not turn the camera off before the monitor switches to the shooting screen.
 - The angle of view (i.e., the area visible in the frame) seen in the saved image is narrower than that seen in the monitor at the time of shooting.

Easy panorama





- From the screen displayed after  **Easy panorama** is selected, select the shooting range from  **Normal (180°)** or  **Wide (360°)**.
- The zoom position is fixed at wide-angle.
- Press the shutter-release button all the way down, remove your finger from the button, and then slowly pan the camera horizontally. Shooting ends when the camera captures the specified shooting range.
- Focus and exposure are locked when shooting starts.
- If you press the  button when a captured image is displayed in full-frame playback mode, the image scrolls automatically.
- The images cannot be edited on this camera.

See "Using Easy Panorama (Shooting and Playback)" ( 2) for more information.



Notes About Printing Panorama Images

The entire image may not be able to be printed depending on the printer's settings. Additionally, printing may not be possible depending on the printer.

Pet portrait

- When you point the camera at a dog or cat, the camera detects the pet's face and focuses on it. By default, the camera detects a dog or cat face and automatically releases the shutter (pet portrait auto release).
- On the screen displayed when  **Pet portrait** is selected, select  **Single** or  **Continuous**.
 -  **Single**: The camera captures one image when a dog or cat face is detected.
 -  **Continuous**: The camera captures three images continuously when a dog or cat face is detected.

Pet Portrait Auto Release

- Press the multi selector  (⏻) to change the **Pet portrait auto release** setting.
 - : The camera detects a dog or cat face and automatically releases the shutter.
 - **OFF**: The camera does not release the shutter automatically, even if a dog or cat face is detected. Press the shutter-release button. The camera also detects human faces when **OFF** is selected.
- **Pet portrait auto release** is set to **OFF** after five bursts have been taken.
- Shooting is also possible by pressing the shutter-release button, regardless of the **Pet portrait auto release** setting. When  **Continuous** is selected, you can take images continuously while holding down the shutter-release button all the way.



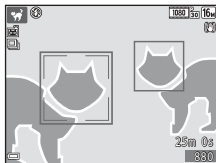

Focus Area

- When the camera detects a face, the face is displayed inside a yellow border. When the camera acquires focus on a face displayed inside a double border (focus area), the double border turns green. If no faces are detected, the camera focuses on the subject in the center of the frame.
- Under some shooting conditions, the pet face may not be detected and other subjects may be displayed inside a border.









Special Effects Mode (Applying Effects When Shooting)

Effects can be applied to images during shooting.

Enter shooting mode →  (shooting mode) button → **S0** (third icon from the top*) →  →   → select an effect →  button

* The icon of the last effect selected is displayed.

Category	Description
S0 Soft* (default setting)	Softens the image by adding a slight blur to the entire image.
SE Nostalgic sepia*	Adds a sepia tone and reduces the contrast to simulate the qualities of an old photograph.
 High-contrast monochrome	Changes the image to black and white and gives it sharp contrast.
 High key	Gives the entire image a bright tone.
 Low key	Gives the entire image a dark tone.
 Selective color	Creates a black and white image in which only the specified color remains.
POP Pop	Increases the color saturation of the entire image to create a bright look.
V1 Super vivid	Increases the color saturation of the entire image and sharpens the contrast.
 Painting	Gives the image a painting-like appearance.
 Toy camera effect 1	Gives the entire image a yellowish hue and darkens the image periphery.

Category	Description
Toy camera effect 2	Decreases the color saturation of the entire image and darkens the image periphery.
Cross process	Gives the image a mysterious appearance based on a specific color.
Mirror*	Creates a bilaterally symmetric image whose right half is an inverted mirror image of the left half.

* Some effects are not available when using certain **Movie options** (📖74) settings.

- The camera focuses on the area in the center of the frame.
- When **Selective color** or **Cross process** is selected, use the multi selector ▲▼ to select the desired color from the slider.

To change settings for any of the following functions, press the **OK** button to cancel color selection.

- Flash mode (📖47)
- Self-timer (📖49)
- Macro mode (📖51)
- Exposure compensation (📖52)

To return to the color selection screen, press the **OK** button again.

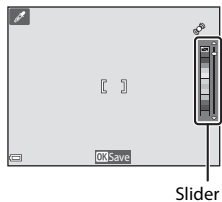

Smart Portrait Mode (Capturing Images of Smiling Faces)

When the camera detects a smiling face, you can take an image automatically without pressing the shutter-release button (smile timer (📖57)). You can use the skin softening option to smooth the skin tones of human faces.

Enter shooting mode → 📷 (shooting mode) button → 😊 Smart portrait → Ⓞ button

1 Frame the picture.

- Point the camera at a human face.

2 Without pressing the shutter-release button, wait for the subject to smile.

- If the camera detects that the face framed by the double border is smiling, the shutter is automatically released.
- Whenever the camera detects a smiling face, it automatically releases the shutter.

3 End automatic shooting.

- Perform one of the operations listed below to end shooting.
 - Set **Smile timer to Off**.
 - Press the 📷 button and select a different shooting mode.





✔ Notes About Smart Portrait Mode

Under some shooting conditions, the camera may be unable to detect faces or smiles (📖61). The shutter-release button can also be used for shooting.

When the Self-timer Lamp Flashes

When using smile timer, the self-timer lamp flashes when the camera detects a face and flashes quickly immediately after the shutter is released.

Functions Available in Smart Portrait Mode

- Flash mode (47)
- Self-timer (49)
- Exposure compensation (52)
- Smart portrait menu (55)





(Auto) Mode

Used for general shooting. Settings can be adjusted to suit the shooting conditions and the type of shot you want to capture.

Enter shooting mode →  (shooting mode) button →  (auto) mode →  button

- You can change how the camera selects the area of the frame to focus on by changing the **AF area mode** setting (47).
The default setting is **Target finding AF** (63).

Functions Available in (Auto) Mode

- Flash mode (47)
- Self-timer (49)
- Macro mode (51)
- Exposure compensation (52)
- Shooting menu (55)

Using Quick Effects

When in  (auto) mode, you can apply effects to images immediately after releasing the shutter.



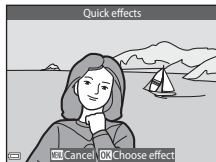

- The edited image is saved as a separate file with a different name.

1 Press the button when the image is displayed after it is taken in (auto) mode.

- When you press the **MENU** button or when no operations are performed for about five seconds, the monitor display returns to the shooting screen.
- To not display the screen shown on the right, set **Quick effects** to **Off** in the shooting menu (55).



2 Use the multi selector to select the desired effect and press the button.

- Move the zoom control (1) toward **T** () to switch to full-frame playback or **W** () to switch to thumbnail playback.
- To exit without saving the edited image, press the **MENU** button. When a confirmation dialog is displayed, select **Yes** and press the  button.
- See "Quick Effects: Changing Hue or Mood" (14) for information about the effect types.

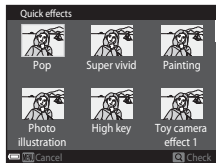

3 Select **Yes** and press the button.





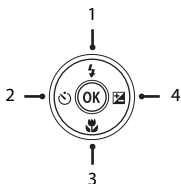

Notes About Quick Effects

The quick effects function is disabled when Wi-Fi is connected.

Functions That Can Be Set Using the Multi Selector

The functions that are available vary depending on the shooting mode, as shown below.



		 (scene auto selector)	Scene	Special effects	Smart portrait	 (auto)
1	 Flash mode (📖47)	✓	*	✓	✓*	✓
2	 Self-timer (📖49)	✓		✓	✓*	✓
3	 Macro mode (📖51)	-		✓	-	✓
4	 Exposure compensation (📖52)	✓		✓	✓	✓

* Availability depends on the setting.

Using the Flash

You can select a flash mode to match the shooting conditions.

- 1 Press the multi selector ▲ (⚡).



- 2 Select the desired flash mode (📖48) and press the **OK** button.

- If a setting is not applied by pressing the **OK** button within a few seconds, the selection will be canceled.

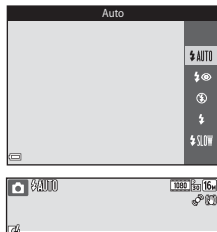

✓ The Flash Lamp

- The status of the flash can be confirmed by pressing the shutter-release button halfway.
 - On: The flash fires when you press the shutter-release button all the way down.
 - Flashing: The flash is charging. The camera cannot shoot images.
 - Off: The flash does not fire when an image is taken.
- If the battery level is low, the monitor turns off while the flash is charging.

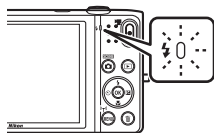

Available Flash Modes

AUTO Auto

The flash fires when necessary, such as in dim lighting.

- The flash mode icon on the shooting screen is displayed only immediately after the setting is made.

Auto with red-eye reduction

Reduce “red-eye” in portraits caused by the flash.

Off

The flash does not fire.

- We recommend using a tripod to stabilize the camera when shooting in dark surroundings.

Fill flash

The flash fires whenever an image is taken. Use to “fill-in” (illuminate) shadows and backlit subjects.

SLOW Slow sync

Suited to evening and night portraits that include background scenery. The flash fires when necessary to illuminate the main subject; slow shutter speeds are used to capture background at night or under dim lighting.

The Flash Mode Setting

- The setting may not be available with some shooting modes.
- The setting applied in  (auto) mode is saved in the camera’s memory even after the camera is turned off.

Red-eye Reduction

If the camera detects red eye while saving an image, the affected area is processed to reduce red-eye before the image is saved.

Note the following when shooting:

- More time than usual is required to save images.
- Red-eye reduction may not produce the desired results in some situations.
- In some rare cases, red-eye reduction may be applied unnecessarily to other areas of the image. In these cases, select another flash mode and take the image again.

Using the Self-timer

The camera is equipped with a self-timer that releases the shutter about ten seconds or two seconds after you press the shutter-release button.

Set **Photo VR** to **Off** in the setup menu (📖77) when using a tripod to stabilize the camera during shooting.

1 Press the multi selector ◀ (🕒).



2 Select 🕒10s or 🕒2s, and press the Ⓞ button.

- 🕒10s (ten seconds): Use on important occasions, such as weddings.
- 🕒2s (two seconds): Use to prevent camera shake.
- If a setting is not applied by pressing the Ⓞ button within a few seconds, the selection will be canceled.
- When the shooting mode is **Pet portrait** scene mode, 🐾 (pet portrait auto release) is displayed (📖39). The self-timer cannot be used.



3 Frame the picture and press the shutter-release button halfway.

- Focus and exposure are set.



4 Press the shutter-release button the rest of the way down.

- Countdown starts. The self-timer lamp flashes and then glows steadily about one second before the shutter is released.
- When the shutter is released, the self-timer is set to **OFF**.
- To stop the countdown, press the shutter-release button again.

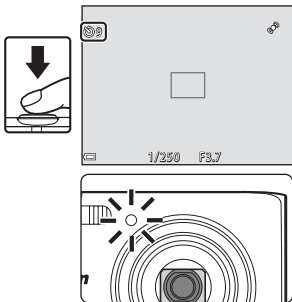

Using Macro Mode

Use macro mode when taking close-up images.

- 1 Press the multi selector ▼ (👉).



- 2 Select **ON** and press the **OK** button.

- If the setting is not applied by pressing the **OK** button within a few seconds, the selection will be canceled.



- 3 Move the zoom control to set the zoom ratio to a position where 📷 and the zoom indicator glow green.



- When the zoom ratio is set to a position where the zoom indicator glows green, the camera can focus on subjects as close as approximately 9 cm (3.6 in.) from the lens. When the zoom is at the position where 📷 is displayed, the camera can focus on subjects as close as approximately 2 cm (0.8 in.) from the lens.

👍 Notes About Using the Flash

The flash may be unable to light the entire subject at distances of less than 50 cm (1 ft 8 in.).

📎 The Macro Mode Setting

- The setting may not be available with some shooting modes.
- The setting applied in 📷 (auto) mode is saved in the camera's memory even after the camera is turned off.

Adjusting Brightness (Exposure Compensation)

You can adjust overall image brightness.

- 1 Press the multi selector ► (⊞).



- 2 Select a compensation value and press the OK button.

- To brighten the image, set a positive (+) value.
- To darken the image, set a negative (-) value.
- The compensation value is applied, even without pressing the OK button.





















































Exposure Compensation Value

The setting applied in  (auto) mode is saved in the camera's memory even after the camera is turned off.

Default Settings

Default settings for each shooting mode are described below.

	Flash ( 47)	Self-timer ( 49)	Macro ( 51)	Exposure compensation ( 52)
 (scene auto selector)	 AUTO ¹	Off	Off ²	0.0
Scene				
 (portrait)	 	Off	Off ³	0.0
 (landscape)	 ³	Off	Off ³	0.0
 (sports)	 ³	Off ³	Off ³	0.0
 (night portrait)	  ⁴	Off	Off ³	0.0
 (party/indoor)	  ⁵	Off	Off ³	0.0
 (beach)	 AUTO	Off	Off ³	0.0
 (snow)	 AUTO	Off	Off ³	0.0
 (sunset)	 ³	Off	Off ³	0.0
 (dusk/dawn)	 ³	Off	Off ³	0.0
 (night landscape)	 ³	Off	Off ³	0.0
 (close-up)		Off	On ³	0.0
 (food)	 ³	Off	On ³	0.0
 (museum)	 ³	Off	Off	0.0
 (fireworks show)	 ³	Off ³	Off ³	0.0 ³
 (black and white copy)		Off	Off	0.0

	Flash (47)	Self-timer (49)	Macro (51)	Exposure compensation (52)
 (backlighting)	 ⁶	Off	Off ³	0.0
 (easy panorama)	 ³	Off ³	Off ³	0.0
 (pet portrait)	 ³	 ⁷	Off	0.0
SO (special effects)	 ³	Off	Off	0.0
 (smart portrait)	 AUTO	Off	Off ³	0.0
 (auto)	 AUTO	Off	Off	0.0

¹ The camera automatically selects the flash mode appropriate for the scene it has selected.  (off) can be selected manually.

² Cannot be changed. The camera enters macro mode when  is selected.

³ The setting cannot be changed.

⁴ The setting cannot be changed. The flash mode setting is fixed at fill flash with red-eye reduction.

⁵ Slow sync with red-eye reduction flash mode may be used.

⁶ Flash is fixed at  (fill flash) when **HDR** is set to **OFF**, and is fixed at  (off) when **HDR** is set to **ON**.

⁷ Self-timer cannot be used. Pet portrait auto release can be turned on or off ([39](#)).

Functions That Can Be Set with the MENU Button (Shooting Menu)

The settings listed below can be changed by pressing the **MENU** button during shooting (📖4).

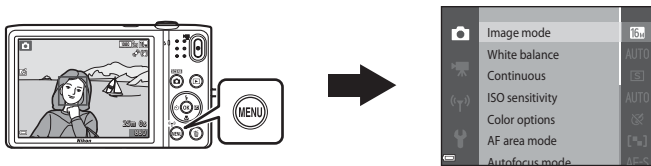













The settings that can be changed vary depending on the shooting mode, as shown below.





	Scene auto selector	Scene ²	Special effects	Smart portrait	Auto mode
Image mode ¹	✓	✓	✓	✓	✓
White balance	-	-	-	-	✓
Continuous	-	-	-	-	✓
ISO sensitivity	-	-	-	-	✓
Color options	-	-	-	-	✓
AF area mode	-	-	-	-	✓
Autofocus mode	-	-	-	-	✓
Quick effects	-	-	-	-	✓
Skin softening	-	-	-	✓	-
Smile timer	-	-	-	✓	-
Blink proof	-	-	-	✓	-

¹ The setting is also applied to other shooting modes.

² Additional settings are available for some scene modes. See "Tips and Notes" (📖35) for more information.

Options Available in the Shooting Menu

Option	Description	
Image mode	Allows you to set the combination of image size and image quality used when saving images. <ul style="list-style-type: none">• Default setting:  4608x3456	 34
White balance	Allows you to adjust white balance to suit the weather conditions or light source in order to make the colors in images match what you see with your eyes. <ul style="list-style-type: none">• Default setting: Auto	 36
Continuous	Allows you to select single or continuous shooting. <ul style="list-style-type: none">• Default setting: Single	 39
ISO sensitivity	Allows you to control the camera's sensitivity to light. <ul style="list-style-type: none">• Default setting: Auto When Auto is selected,  is displayed in the monitor while shooting if ISO sensitivity increases.	 42
Color options	Allows you to change the color tones of images. <ul style="list-style-type: none">• Default setting: Standard color	 43
AF area mode	Allows you to determine how the camera selects the focus area that is used for autofocus. <ul style="list-style-type: none">• Default setting: Target finding AF (63)	 44
Autofocus mode	Allows you to select either Single AF , which focuses only when the shutter-release button is pressed halfway, or Full-time AF , which continues focusing even when the shutter-release button is not pressed halfway. <ul style="list-style-type: none">• Default setting: Single AF	 48
Quick effects	Allows you to enable or disable the quick effects function ( 45). <ul style="list-style-type: none">• Default setting: On	 48

Option	Description	
Skin softening	Allows you to select the skin softening level for human faces. <ul style="list-style-type: none"> • Default setting: Normal 	 49
Smile timer	Allows you to select whether or not the camera automatically releases the shutter when it detects a human smiling face. <ul style="list-style-type: none"> • Default setting: On (BSS) 	 50
Blink proof	The camera automatically releases the shutter twice with every shot and saves one image in which the subject's eyes are open. <ul style="list-style-type: none"> • Default setting: Off 	 51

Functions That Cannot Be Used Simultaneously

Some functions cannot be used with other menu options.

Restricted function	Option	Description
Flash mode	Continuous (📖56)	When a setting other than Single is selected, the flash cannot be used.
	Blink proof (📖57)	When Blink proof is set to On , the flash cannot be used.
	Smile timer (📖57)	When On (continuous) or On (BSS) is selected, the flash cannot be used.
Self-timer	Smile timer (📖57)	When Smile timer is selected, the self-timer cannot be used.
	AF area mode (📖56)	When Subject tracking is selected, the self-timer cannot be used.
Macro mode	AF area mode (📖56)	When Subject tracking is selected, macro mode cannot be used.
Image mode	Continuous (📖56)	<p>Image mode is set as follows depending on the continuous shooting setting:</p> <ul style="list-style-type: none"> • Continuous H: 120 fps: VGA (image size: 640 × 480 pixels) • Continuous H: 60 fps: 1M (image size: 1280 × 960 pixels) • Multi-shot 16: 5M (image size: 2560 × 1920 pixels)
White balance	Color options (📖56)	When Black-and-white, Sepia , or Cyanotype is selected, the White balance setting is fixed at Auto .

Restricted function	Option	Description
Continuous	Self-timer (📖49)	If the self-timer is used when Pre-shooting cache is selected, the setting is fixed at Single .
ISO sensitivity	Continuous (📖56)	When Pre-shooting cache , Continuous H: 120 fps , Continuous H: 60 fps , or Multi-shot 16 is selected, ISO sensitivity is fixed at Auto .
AF area mode	White balance (📖56)	When a setting other than Auto is selected for White balance in Target finding AF mode, the camera does not detect the main subject.
Quick effects	Continuous (📖56)	The quick effects function cannot be used for images with continuous shooting.
Smile timer	Blink proof (📖57)	When Blink proof is set to On , Smile timer is fixed at On (single) if On (continuous) or On (BSS) is set.
Blink proof	Smile timer (📖57)	When Smile timer is set to On (continuous) or On (BSS) , Blink proof is fixed at Off .
Monitor settings	Quick effects (📖56)	When Quick effects is set to On while shooting still images, the captured image is displayed after shooting, regardless of the Image review setting.
Print date	Continuous (📖56)	When Pre-shooting cache , Continuous H: 120 fps , or Continuous H: 60 fps is selected, date and time cannot be imprinted on images.

Restricted function	Option	Description
Motion detection	Continuous (📖56)	When a setting other than Single is selected, Motion detection is disabled.
	ISO sensitivity (📖56)	When the ISO sensitivity is set to any setting other than Auto , Motion detection is disabled.
	AF area mode (📖56)	When Subject tracking is selected, Motion detection is disabled.
	Smile timer (📖57)	When On (continuous) or On (BSS) is selected, Motion detection is disabled.
Blink warning	Continuous (📖56)	When a setting other than Single is selected, Blink warning is disabled.
Digital zoom	Continuous (📖56)	When Multi-shot 16 is selected, digital zoom cannot be used.
	AF area mode (📖56)	When Subject tracking is selected, digital zoom cannot be used.
Shutter sound	Continuous (📖56)	When a setting other than Single is selected, the shutter sound is disabled.

✔ Notes About Digital Zoom

- Depending on the shooting mode or the current settings, digital zoom may not be available (📷81).
- When digital zoom is in effect, the camera focuses in the center of the frame.

Focusing

The focus area varies depending on the shooting mode.

Using Face Detection

In the following shooting modes, the camera uses face detection to automatically focus on human faces.

- **Portrait**, **Night portrait**, or **Smart portrait**
- **Backlighting** in **Scene auto selector** mode (32)
- **Portrait** or **Night portrait** scene mode (34)
- Smart portrait mode (42)
- When **AF area mode** (56) in **(auto)** mode (44) is set to **Face priority**.

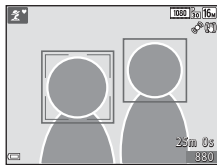

If the camera detects more than one face, a double border is displayed around the face that the camera focuses on, and single borders are displayed around the other faces.

If the shutter button is pressed halfway when no faces are detected:





- In **Scene auto selector** mode, the focus area changes depending on the scene.
- In **Portrait** and **Night portrait** scene modes or in smart portrait mode, the camera focuses in the center of the frame.
- In **(auto)** mode, the camera selects the focus area containing the subject closest to the camera.

✓ Notes About Face Detection

- The camera's ability to detect faces depends on a variety of factors, including the direction in which the faces are looking.
- The camera may be unable to detect faces in the following situations:
 - When faces are partially hidden by sunglasses or otherwise obstructed
 - When faces take up too much or too little of the frame

Using Skin Softening

When the shutter is released while using one of the shooting modes listed below, the camera detects human faces and processes the image to soften facial skin tones (up to three faces).

- Smart portrait mode (📖42)
 - The skin softening level can be adjusted.
-  **Portrait**,  **Night portrait**, or  **Backlighting** in  (scene auto selector) mode (📖32)
- **Portrait** or **Night portrait** scene mode (📖34)

Editing functions such as **Skin softening** can be applied to saved images by using **Glamour retouch** (📖68) even after shooting.

Notes About Skin Softening

- It may take more time than usual to save images after shooting.
- Under some shooting conditions, the desired skin softening results may not be achieved, and skin softening may be applied to areas of the image where there are no faces.

Using Target Finding AF

When **AF area mode** (📖56) in 📷 (auto) mode is set to **Target finding AF**, the camera focuses in the manner described below when you press the shutter-release button halfway.

- The camera detects the main subject and focuses on it. When the subject is in focus, the focus area glows green. If a human face is detected, the camera automatically sets focus priority on it.
- If no main subject is detected, the camera automatically selects one or more of the nine focus areas containing the subject closest to the camera. When the subject is in focus, the focus areas that are in focus glow green.

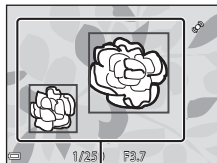

Focus areas

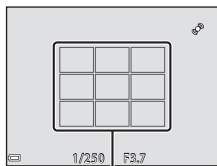

Focus areas

✔ Notes About Target Finding AF

- Depending on shooting conditions, the subject that the camera determines to be the main subject may vary.
- The main subject may not be detected when using certain **White balance** settings.
- The camera may not detect the main subject appropriately in the following situations:
 - When the subject is very dark or bright
 - When the main subject lacks clearly defined colors
 - When the shot is framed so that the main subject is at the edge of the monitor
 - When the main subject is composed of a repeating pattern

Subjects Not Suitable for Autofocus

The camera may not focus as expected in the following situations. In some rare cases, the subject may not be in focus despite the fact that the focus area or the focus indicator glows green:

- Subject is very dark
- Objects of sharply differing brightness are included in the scene (e.g. the sun behind the subject makes that subject appear very dark)
- No contrast between the subject and surroundings (e.g. a portrait subject wearing a white shirt is standing in front of a white wall)
- Several objects are at different distances from the camera (e.g. the subject is inside a cage)
- Subjects with repeating patterns (window blinds, buildings with multiple rows of similarly shaped windows, etc.)
- Subject is moving rapidly

In the situations noted above, try pressing the shutter-release button halfway to refocus several times, or focus on another subject positioned at the same distance from the camera as the actual desired subject, and use focus lock (📖65).

Focus Lock

Focus lock shooting is recommended when the camera does not activate the focus area that contains the desired subject.

1 Set **AF area mode** to **Center** in  (auto) mode (55).

2 Position the subject in the center of the frame and press the shutter-release button halfway.

- The camera focuses on the subject and the focus area glows green.
- Focus and exposure are locked.

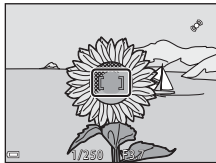

3 Without lifting your finger, recompose the picture.

- Make sure to maintain the same distance between the camera and the subject.

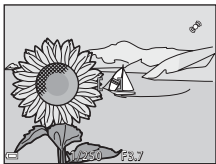

4 Press the shutter-release button the rest of the way down to take the picture.



Playback Features

Playback Zoom

Moving the zoom control toward **T** (Q) in full-frame playback mode (📖28) zooms in on the image.

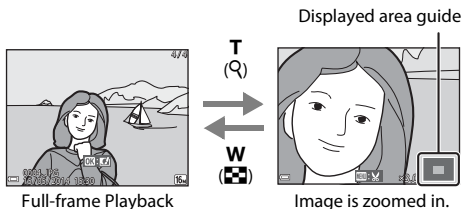

- You can change the zoom ratio by moving the zoom control toward **W** (📐) or **T** (Q).
- To view a different area of the image, press the multi selector ▲▼◀▶.
- If you are viewing an image that was captured using face detection or pet detection, the camera zooms in on the face detected at the time of shooting (except when viewing an image captured in a series). To zoom in on an area of the image where there are no faces, adjust the magnification rate and then press ▲▼◀▶.
- When a zoomed image is displayed, press the **OK** button to return to full-frame playback mode.

Cropping Images

When a zoomed image is displayed, you can press the **MENU** button to crop the image to include only the visible portion and save it as a separate file (🔧21).

Thumbnail Playback/Calendar Display

Moving the zoom control toward **W** (🗉) in full-frame playback mode (📖28) displays images as thumbnails.













- You can change the number of thumbnails displayed by moving the zoom control toward **W** (🗉) or **T** (🔍).
- While using thumbnail playback mode, press the multi selector ▲▼◀▶ to select an image and then press the **OK** button to display that image in full-frame playback mode.
- While using calendar display mode, press ▲▼◀▶ to select a date and then press the **OK** button to display the images captured on that day.









✓ Notes About Calendar Display

Images captured when the camera's date is not set are treated as images captured on January 1, 2014.

Functions That Can Be Set with the MENU Button (Playback Menu)

When viewing images in full-frame playback mode or thumbnail playback mode, you can configure the menu operations listed below by pressing the **MENU** button (📖4).

Option	Description	
Quick retouch*	Allows you to create retouched copies in which contrast and saturation have been enhanced.	 16
D-Lighting*	Allows you to create copies with enhanced brightness and contrast, brightening dark portions of an image.	 16
Red-eye correction*	Corrects “red-eye” that may occur in images when shooting with a flash.	 17
Glamour retouch*	Detects faces in images and retouches the detected faces glamorously.	 18
Print order	Allows you to select which images are printed, and how many copies of each image are printed, prior to printing.	 52
Slide show	Allows you to view images in an automatic slide show.	 56
Protect	Protects selected images from accidental deletion.	 57
Rotate image	Allows you to rotate the displayed image to portrait or landscape orientation.	 59
Small picture*	Creates a small copy of images.	 20
Voice memo	Allows you to use the camera’s microphone to record voice memos and attach them to images.	 60

Option	Description	
Copy	Allows you to copy images between the internal memory and a memory card.	 61
Sequence display options	<p>Allows you to select whether to display only the key picture for a sequence of images captured continuously or to display the sequence as individual images.</p> <ul style="list-style-type: none"> When only the key picture is displayed for a sequence, press the  button to display each image in the sequence. Press the multi selector  to return to the key picture display. 	 63
Choose key picture	Allows you to change the key picture for images captured in sequence.	 63
Favorite pictures	Allows you to add images to an album. This option is not displayed in favorite pictures mode.	 66
Remove from favorites	Allows you to remove images from an album. This option is displayed only in favorite pictures mode.	 8

* Edited images are saved as separate files. Some images may not be edited.

Recording and Playing Back Movies

Recording Movies

1 Display the shooting screen.

- Check the remaining amount of movie recording time.
- If **Photo info** in the **Monitor settings** in the setup menu (☰77) is set to **Movie frame+auto info**, the area that will be visible in the movie can be confirmed before movie recording starts.



Movie recording time remaining

2 Press the **Movie-record** button to start movie recording.

- The camera focuses in the center of the frame.
- Press the multi selector **▶** to pause recording, and press **▶** again to resume recording (except when **iFrame 720/30p** (**iFrame iFrame 720/25p**) or an HS movie option is selected in **Movie options**). Recording automatically ends if it remains paused for about five minutes.
- A still image can be captured during movie recording (☰73).

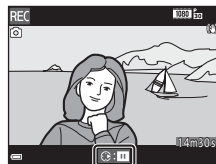
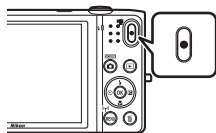

3 Press the **Movie-record** button again to end recording.

✔ Maximum Movie Length

Individual movie files cannot exceed 4 GB in size or 29 minutes in length, even when there is sufficient free space on the memory card for longer recording.

- The maximum movie length for a single movie is displayed on the shooting screen.
- Recording may end before either limit is reached if camera temperature becomes elevated.
- The actual movie length may vary depending on the movie content, subject movement, or type of memory card.



✔ Notes About Saving Images and Recording Movies

The indicator showing the number of exposures remaining or the indicator showing the maximum movie length flashes while images are being saved or while a movie is being recorded. **Do not open the battery-chamber/memory card slot cover or remove the battery or memory card** while an indicator is flashing. Doing this could result in loss of data, or in damage to the camera or the memory card.

✔ Notes About Movie Recording

- Memory cards with an SD Speed Class rating of 6 or faster are recommended when recording movies (U22). Movie recording may stop unexpectedly when memory cards with a lower Speed Class rating are used.
- There may be some degradation in image quality when digital zoom is used.
- The sounds of zoom control operation, zoom, autofocus lens drive movement, movie vibration reduction, and aperture operation when brightness changes may be recorded.
- The following phenomena may be seen in the monitor while recording movies. These phenomena are saved in the recorded movies.
 - Banding may occur in images under fluorescent, mercury-vapor, or sodium-vapor lighting.
 - Subjects that move quickly from one side of the frame to the other, such as a moving train or car, may appear skewed.
 - The entire movie image may be skewed when the camera is panned.
 - Lighting or other bright areas may leave residual images when the camera is moved.
- Depending on the distance to the subject or the amount of zoom applied, subjects with repeating patterns (fabrics, lattice windows, etc.) may have colored stripes (interference patterns, moiré, etc.) in them during movie recording and playback. This occurs when the pattern in the subject and the layout of the image sensor interfere with each other; it is not a malfunction.

✔ Notes About Vibration Reduction During Movie Recording

- When **Movie VR** in the movie menu (74) is set to **On (hybrid)**, the angle of view (i.e., the area visible in the frame) becomes narrower during movie recording.
- In special effects mode, only lens shift VR is used to compensate for camera shake when **Movie options** is set to  **1080/60i** ( **1080/50i**), even if **Movie VR** is set to **On (hybrid)**.
- When using a tripod to stabilize the camera during shooting, set **Movie VR** to **Off** to prevent potential errors caused by this function.

✔ Notes About Camera Temperature

- The camera may become hot when shooting movies for an extended period of time or when the camera is used in a hot area.
- If the inside of the camera becomes extremely hot when recording movies, the camera will automatically stop recording.
The amount of time remaining until the camera stops recording (10s) is displayed.
After the camera stops recording, it turns itself off.
Leave the camera off until the inside of the camera has cooled.



✔ Notes About Autofocus for Movie Recording

Autofocus may not perform as expected (64). Should this occur, try the following:

1. Set **Autofocus mode** in the movie menu to **Single AF** (default setting) before starting movie recording.
2. Frame another subject (positioned at the same distance from the camera as the intended subject) in the center of the frame, press the  movie-record) button to start recording, and modify the composition.



Capturing Still Images While Recording Movies

If the shutter-release button is pressed all the way while recording a movie, one frame is saved as a still image. Movie recording continues while the still image is being saved.

-  is displayed at the top left of the monitor. When  is displayed, still images cannot be captured.
- The size of the captured image varies depending on the **Movie options** setting (74).



Notes About Capturing Still Images During Movie Recording







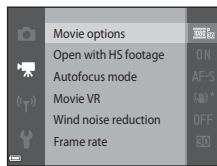

- Still images cannot be captured during a movie recording in the following situations:
 - When the remaining movie recording time is less than 30 seconds
 - When **Movie options** is set to  **1080/60i** ( **1080/50i**) or HS movie
- Frames of a movie that were recorded when a still image was being taken may not be played back in a seamless manner.
- The sound of pressing the shutter-release button may be recorded in the movie.
- If the camera moves when the shutter-release button is pressed, the image may be blurred.

Functions That Can Be Set with the MENU Button (Movie Menu)

Enter shooting mode → MENU button →  menu icon →  button

The settings of the menu options listed below can be configured.



Option	Description	
Movie options	Select the movie type. Select normal speed to record movies at normal speed, or HS (high speed) to record movies that play in slow or fast motion. <ul style="list-style-type: none"> Default setting:  1080/30p  1080/25p 	 64
Open with HS footage	Set whether to start recording at high speed or normal speed when recording HS movies. <ul style="list-style-type: none"> Default setting: On 	 68
Autofocus mode	Select either Single AF , which locks focus when movie recording begins, or Full-time AF , which continues focusing during movie recording. <ul style="list-style-type: none"> Default setting: Single AF 	 68
Movie VR	Select the vibration reduction setting used when recording movies. <ul style="list-style-type: none"> Default setting: On (hybrid) 	 69
Wind noise reduction	Set whether or not to reduce wind noise during movie recording. <ul style="list-style-type: none"> Default setting: Off 	 70
Frame rate	Select the frame rate for recording movies based on the setting of the TV used for playing back movies. <ul style="list-style-type: none"> NTSC: 30 fps (30p/60i) PAL: 25 fps (25p/50i) 	 70

Playing Back Movies

Press the  button to enter playback mode.

Movies are indicated by the movie options icon (74).

Press the  button to play back movies.

- To adjust the volume, move the zoom control while a movie is playing (1).

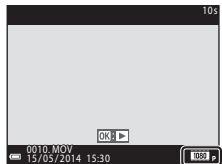

Movie options

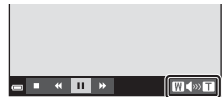

Volume indicator

Operation During Movie Playback

Playback controls are displayed at the bottom of the monitor. The operations listed below can be performed by using the multi selector ◀▶ to select a control and then pressing the OK button.



Function	Icon	Description
Rewind		Hold down the OK button to rewind the movie.
Advance		Hold down the OK button to advance the movie.
Pause		Pause playback. The operations listed below can be performed while paused.
		Rewind the movie one frame. Hold down the OK button for continuous rewinding.
		Advance the movie one frame. Hold down the OK button for continuous advancing.
		Resume playback.
		Extract the desired portion of a movie and save it as a separate file.
End		Return to full-frame playback mode.

Deleting Movies

To delete a movie, select the desired movie in full-frame playback mode (📖28) or thumbnail playback mode (📖67) and press the button (📖30).







General Camera Setup

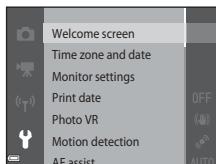











Functions That Can Be Set with the MENU Button (Setup Menu)

Press the **MENU** button → **Y** (setup) menu icon → **OK** button

The settings of the menu options listed below can be configured.



Option	Description	
Welcome screen	Allows you to select whether or not the welcome screen is displayed when the camera is turned on.	 73
Time zone and date	Allows you to set the camera clock.	 74
Monitor settings	Allows you to adjust photo information display, post-shooting image review, and monitor brightness settings.	 76
Print date	Allows you to imprint the shooting date and time on images.	 78
Photo VR	Allows you to select the vibration reduction setting used when shooting still images.	 79
Motion detection	Allows you to set whether or not the camera reduces blurring caused by camera shake if motion is detected when shooting still images.	 80

Option	Description	
AF assist	Allows you to enable or disable the AF-assist illuminator.	 81
Digital zoom	Allows you to enable and disable digital zoom.	 81
Sound settings	Allows you to adjust sound settings.	 82
Auto off	Allows you to set the amount of time that passes before the monitor turns off to save power.	 82
Format memory/ Format card	Allows you to format the internal memory or the memory card.	 83
Language	Allows you to change the camera's display language.	 84
TV settings	Allows you to adjust TV-connection settings.	 84
Charge by computer	Allows you to set whether or not the battery in the camera is charged when the camera is connected to a computer.	 85
Blink warning	Allows you to set whether or not closed eyes are detected when taking images of people using face detection.	 86
Eye-Fi upload	Allows you to set whether or not to enable the function for sending images to a computer using a commercially available Eye-Fi card.	 87
Reset all	Allows you to reset the camera's settings to their default values.	 88
Firmware version	View the current camera firmware version.	 88

Using the Wi-Fi (Wireless LAN) Function

Functions That Can Be Performed Using Wi-Fi

You can perform the following functions if you install the dedicated software “Wireless Mobile Utility” on your smart device that runs on Android OS or iOS, and connect it to the camera.

Take Photos

You can take still images using the two methods described below.

- Release the shutter on the camera and save the captured images to a smart device.
- Use a smart device to remotely* release the camera shutter and save images to the smart device.

* Operations cannot be performed on the camera during remote control operation.

View Photos

You can copy the images saved in the camera’s memory card and view them on your smart device.

Installing the Software on the Smart Device

- 1** Use your smart device to connect to Google Play Store, App Store or other online apps marketplace and search for “Wireless Mobile Utility.”
 - Check the user’s manual provided with your smart device for further details.
- 2** Check the description and other information and install the software.
 - For more information about how to operate the software, download the user’s manual from the website below.
 - Android OS: <http://nikonimglib.com/ManDL/WMAU/>
 - iOS: <http://nikonimglib.com/ManDL/WMAU-ios/>

Connecting the Smart Device to the Camera

Press the MENU button → “T” menu icon → OK button

1 Use the multi selector ▲▼ to select **Connect to smart device** and press the OK button.

- If **Connect to smart device** cannot be selected, see “Notes About Wi-Fi Connection” (82).
- When the Wi-Fi function is turned on, the SSID and password of the camera are displayed.
- If no connection confirmation is received from the smart device within 3 minutes, the message “No access.” is displayed and the camera returns to the Wi-Fi options screen.

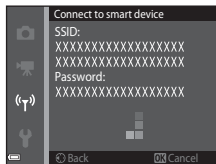
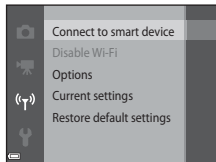

2 Set the Wi-Fi setting on the smart device to On.

- Check the user's manual provided with your smart device for further details.
- After the network name (SSID) that can be used for the smart device is displayed, select the SSID displayed on the camera.
- When the message for entering a password is displayed, enter the password that is displayed on the camera.
- When the camera is successfully connected to a Wi-Fi network, the shooting screen is displayed on the camera with the Wi-Fi communication indicator (7).

3 Start the “Wireless Mobile Utility” installed on the smart device.

- The screen for selecting “Take photos” or “View photos” is displayed.
- When the message “Cannot connect to camera.” is displayed, return to step 1 and retry the procedure.

To Terminate the Wi-Fi Connection

Perform one of the following operations.

- Turn off the camera.
- Select **Disable Wi-Fi** in the Wi-Fi options menu on the camera (except when the camera is operated by remote control).
- Set the Wi-Fi setting on the smart device to Off.



Notes About Wi-Fi Connection

- **Connect to smart device** cannot be selected in the following situations:
 - When no memory card is inserted in the camera
 - When an Eye-Fi card (🔌87) is inserted in the camera
 - When the camera is connected to a TV, computer, or printer.
 - When the battery level indicator in the monitor indicates . In addition, if is indicated when Wi-Fi is connected, the connection is terminated.
- Select **Disable Wi-Fi** in a place where the use of radio waves is prohibited.
- When Wi-Fi is connected, **Auto off** is disabled.
- When Wi-Fi is connected, the battery drains faster than normal.



Notes About Security Settings

If the camera is installed with the Wi-Fi function without proper security settings (encryption and password), unauthorized third parties may access the network and cause harm. We strongly recommend performing the required security settings before using the Wi-Fi function.

Use **Options** of the Wi-Fi options menu (🔌71) to perform the security settings.

Connecting the Camera to a TV, Computer, or Printer

Connection Methods

You can enhance your enjoyment of images and movies by connecting the camera to a TV, computer, or printer.

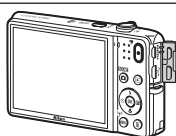
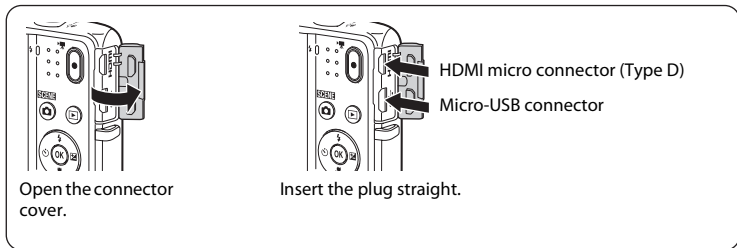

- Before connecting the camera to an external device, make sure the remaining battery level is sufficient and turn the camera off. Before disconnecting, make sure to turn the camera off.
- If the AC Adapter EH-62G (available separately) is used, this camera can be powered from an electrical outlet. Do not use any other make or model of AC adapter as it may cause the camera to heat up or malfunction.
- For information about the connection methods and subsequent operations, refer to the documentation included with the device in addition to this document.

Viewing images on a TV 22

Images and movies captured with the camera can be viewed on a TV. Connection method: Connect a commercially available HDMI cable to the TV's HDMI input jack.

Viewing and organizing images on a computer 85

You can transfer images to a computer to perform simple retouching and manage image data. Connection method: Connect the camera to the computer's USB port with the USB cable.

- Before connecting to a computer, install ViewNX 2 on the computer ( 85).
- If any USB devices that draw the power from the computer are connected, disconnect them from the computer before you connect the camera to it. Connecting the camera and other USB-powered devices to the same computer simultaneously may cause a camera malfunction or excessive power supply from the computer, which could damage the camera or memory card.

Printing images without using a computer 25

If you connect the camera to a PictBridge-compatible printer, you can print images without using a computer. Connection method: Connect the camera directly to the printer's USB port with the USB cable.

Using ViewNX 2

Install ViewNX 2 to upload, view, edit, and share photos and movies.



Installing ViewNX 2

An Internet connection is required.

For system requirements and other information, see the Nikon website for your region.

- 1** Start the computer and download the ViewNX 2 installer from the URL below.

<http://nikonimglib.com/nvnx/>

- 2** Double-click the installer file.

3 Follow the on-screen instructions to install the software.

4 Exit the install.

- Windows: Click **Yes**.
- Mac: Click **OK**.

Transferring Images to the Computer

1 Choose how images will be copied to the computer.

Choose one of the following methods:

- **Direct USB connection:** Turn the camera off and ensure that the memory card is inserted in the camera. Connect the camera to the computer using the USB cable. The camera automatically turns on. To transfer images that are saved in the camera's internal memory, remove the memory card from the camera before connecting it to the computer.

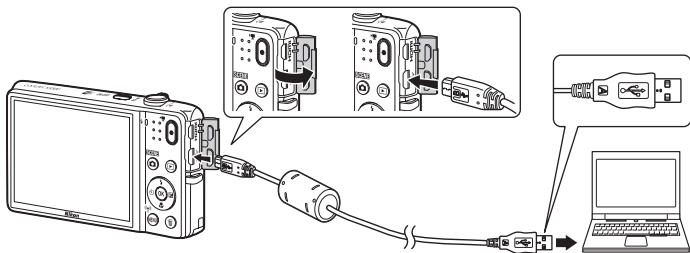

- **SD card slot:** If your computer is equipped with an SD card slot, the card can be inserted directly in the slot.
- **SD card reader:** Connect a card reader (available separately from third-party suppliers) to the computer and insert the memory card.

If a message is displayed prompting you to choose a program, select Nikon Transfer 2.

- **When using Windows 7**

If the dialog shown at right is displayed, follow the steps below to select Nikon Transfer 2.

- 1 Under **Import pictures and videos**, click **Change program**. A program selection dialog will be displayed; select **Import File using Nikon Transfer 2** and click **OK**.
- 2 Double-click **Import File**.



If the memory card contains a large number of images, it may take a while for Nikon Transfer 2 to start. Wait until Nikon Transfer 2 starts.

Connecting the USB Cable

The connection may not be recognized if the camera is connected to the computer via a USB hub.

2 Transfer images to the computer.

- Click **Start Transfer**.

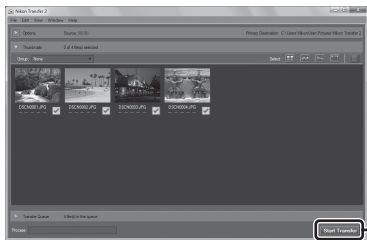

- At default settings, all the images on the memory card will be copied to the computer.

3 Terminate the connection.

- If the camera is connected to the computer, turn the camera off and disconnect the USB cable. If you are using a card reader or card slot, choose the appropriate option in the computer operating system to eject the removable disk corresponding to the memory card and then remove the card from the card reader or card slot.

Viewing Images

Start ViewNX 2.

- Images are displayed in ViewNX 2 when transfer is complete.
- Consult online help for more information on using ViewNX 2.



Starting ViewNX 2 Manually

- **Windows:** Double-click the **ViewNX 2** shortcut on the desktop.
- **Mac:** Click the **ViewNX 2** icon in the Dock.



A series of ten horizontal dashed lines spanning the width of the page, intended for handwriting practice.



Reference Section

The Reference Section provides detailed information and hints for using the camera.

Shooting

Using Easy Panorama (Shooting and Playback) 2

Playback

Favorite Pictures Mode..... 6
Auto Sort Mode 10
List by Date Mode 11
Viewing and Deleting Images Captured Continuously (Sequence) 12
Editing Images (Still Images) 14
Connecting the Camera to a TV (Playback on a TV)..... 22
Connecting the Camera to a Printer (Direct Print) 24
Editing Movies 32

Menu









The Shooting Menu (for (Auto) Mode)..... 34
The Smart Portrait Menu..... 49
The Playback Menu..... 52
The Movie Menu 64
The Wi-Fi Options Menu 71
The Setup Menu..... 73

Additional Information



Error Messages 89
File Names 94
Optional Accessories 95



Using Easy Panorama (Shooting and Playback)

Shooting with Easy Panorama

Enter shooting mode →  (shooting mode) button →  (second icon from the top*)
→     →  (easy panorama) →  button

* The icon of the last scene selected is displayed.

1 Select  **Normal (180°)** or  **Wide (360°)** as the shooting range and press the  button.

- When the camera is readied in the horizontal position, the image size (width × height) is as follows.
 -  **Normal (180°)**: 4800 × 920 when moved horizontally, 1536 × 4800 when moved vertically
 -  **Wide (360°)**: 9600 × 920 when moved horizontally, 1536 × 9600 when moved vertically

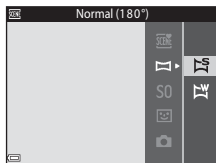

2 Frame the first edge of the panorama scene, and then press the shutter-release button halfway to focus.

- The zoom position is fixed at wide-angle position.
- The camera focuses in the center of the frame.

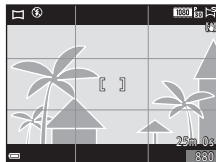

- 3** Press the shutter-release button all the way, and then remove your finger from the shutter-release button.

- $\triangle \nabla \langle \rangle$ are displayed to indicate the direction of camera movement.



- 4** Move the camera in one of the four directions until the guide indicator reaches the end.

- When the camera detects which direction it is moving in, shooting begins.

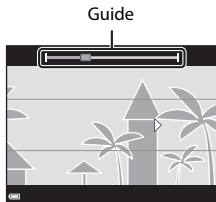

Example of camera movement



- Using your body as the axis of rotation, move the camera slowly in an arc, in the direction of the marking ($\triangle \nabla \langle \rangle$).
- Shooting stops if the guide does not reach the edge within about 15 seconds (when **Normal (180°)** is selected) or within about 30 seconds (when **Wide (360°)** is selected) after shooting starts.

Notes About Easy Panorama Shooting

- The range of the image seen in the saved image is narrower than that seen in the monitor at the time of shooting.
- If the camera is moved too quickly or shaken too much, or if the subject is too uniform (e.g. walls or darkness), an error may occur.
- If shooting is stopped before the camera reaches the half-way point in the panorama range, a panorama image is not saved.
- If more than half of the panorama range is captured but shooting ends before reaching the edge of the range, the range not captured is recorded and displayed in gray.

Viewing Images Captured with Easy Panorama

Switch to playback mode (📖28), display an image captured using easy panorama in full-frame playback mode, and then press the **OK** button to scroll the image in the direction that was used when shooting.

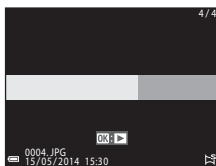

Playback controls are displayed at the bottom of the monitor during playback. Use the multi selector **◀▶** to select a control, and then press the **OK** button to perform the following operations.

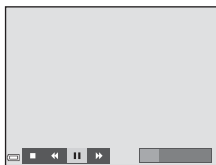

Function	Icon	Description	
Rewind	⏮	Hold down the OK button to scroll backward quickly.	
Advance	⏭	Hold down the OK button to scroll forward quickly.	
Pause	⏸	Pause playback. The operations listed below can be performed while paused.	
		⏮	Hold down the OK button to rewind.
		⏭	Hold down the OK button to scroll.
		▶	Resume automatic scrolling.
End	■	Switch to full-frame playback mode.	

👍 Notes About Scroll Playback

This camera may not be able to scroll the playback of, or zoom in on, easy panorama images captured with another make or model of digital camera.

Favorite Pictures Mode







By adding images (except movies) to albums as favorite pictures, you can play back only the added images.

- Images can be sorted into nine albums. Up to 200 images can be added to each album.
- The original images are not copied or moved.
- The same image can be added to multiple albums.

Adding Images to Albums

Press the  button (playback mode) → MENU button → Favorite pictures →  button

1 Use the multi selector  to select an image and use  to display .

- You can add  to multiple images. To remove , press .
- Move the zoom control () toward **T** () to switch to full-frame playback or **W** () to switch to thumbnail playback.





2 Press the  button after configuring the settings.

3 Select the desired album and press the  button.

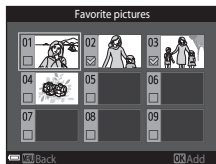

- The selected images are added.



Playing Back Images in Albums

Press the  button (playback mode) →  button →  Favorite pictures →  button

Use the multi selector to select an album and then press the  button to play back the images in the selected album.

- Functions in the playback menu ( 68) can be used for the images in the selected album (except **Copy** and **Favorite pictures**).
- The following operations are available from the album selection screen.
 - **MENU** button: Changes the album icon ( 9).
 -  button: Deletes all original images added to the selected album.

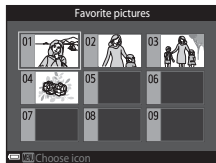

Notes About Deletion

If an image is deleted while using favorite pictures mode, the original image is deleted. When removing images from albums, see “Removing Images from Albums” ( 8).

Removing Images from Albums

Enter **★** Favorite pictures mode → select the album containing the image you want to remove → **OK** button → **MENU** button → Remove from favorites → **OK** button

1 Use the multi selector **◀▶** to select an image and use **▲** to hide **★**.

- To display the icons again, press **▼**.
- Move the zoom control (**□1**) toward **T** (**Q**) to switch to full-frame playback or **W** (**⊞**) to switch to thumbnail playback.



2 Press the **OK** button after configuring the settings.

3 Select **Yes** and press the **OK** button.



- To cancel removal, select **No**.

Changing the Favorites Album Icon

Press the  button (playback mode) →  button →  Favorite pictures →  button

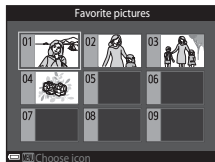
- 1 Use the multi selector to select an album and press the **MENU** button.



- 2 Use   to select an icon color and press the  button.

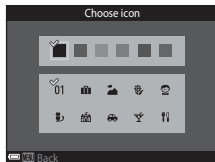



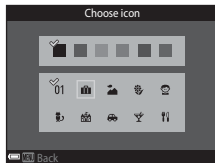

- 3 Select an icon and press the  button.
 - The icon changes.





Auto Sort Mode

Images are automatically sorted into categories, such as portraits, landscapes, and movies, based on the camera settings at the time of shooting.

Press the  button (playback mode) →  button →  Auto sort →  button

Use the multi selector to select a category and then press the  button to play back the images in the selected category.

- Functions in the playback menu ( 68) can be used for the images in the selected category (except **Copy** and **Remove from favorites**).
- While the category selection screen is displayed, press the  button to delete all original images in the selected category.

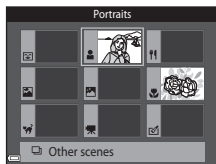

Notes About Auto Sort Mode

- Up to 999 images and movie files can be sorted into each category in auto sort mode.
- Images or movies saved by cameras other than this camera cannot be played back in auto sort mode.

List by Date Mode

Press the button (playback mode) → button → List by date → button

Use the multi selector to select a date and then press the button to play back the images captured on the selected date.

- Functions in the playback menu (68) can be used for the images in the selected shooting date (except **Copy** and

Remove from favorites).

- The following operations are available while the shooting date selection screen is displayed.
 - **MENU** button: The functions listed below are available.
 - Print order*
 - Slide show
 - Protect*
 - * The same settings can be applied to all images captured on the selected date.
 - button: Deletes all images captured on the selected date.

List by date		
	20/05/2014	[3]
	15/05/2014	[2]
	10/05/2014	[1]
	05/05/2014	[10]

Notes About List by Date Mode

- Up to the most recent 29 dates can be selected. If images exist for more than 29 dates, all images saved earlier than the most recent 29 dates will be combined under **Others**.
- The 9,000 most recent images can be displayed.
- Images captured when the camera's date is not set are treated as images captured on January 1, 2014.

Viewing and Deleting Images Captured Continuously (Sequence)

Viewing Images in a Sequence

Images captured continuously are saved as a sequence.

The first image of a sequence is used as the key picture to represent the sequence when displayed in full-frame playback mode or thumbnail playback mode (default setting).

To display each image in the sequence individually, press the **OK** button.

After pressing the **OK** button, the operations listed below are available.

- To display the previous or next image, press the multi selector ◀▶.
- To display images that are not included in the sequence, press ▲ to return to the key picture display.
- To display images in a sequence as thumbnails, or to play them back in a slide show, set **Sequence display options** to **Individual pictures** in the playback menu (663).



Sequence Display Options

Images captured continuously with cameras other than this camera cannot be displayed as a sequence.



Playback Menu Options Available When Using Sequence

- When images in a sequence are displayed in full-frame playback mode, press the **MENU** button to select functions in playback menu (📖68).
 - If you press the **MENU** button when a key picture is displayed, the following settings can be applied to all images in the sequence:
 - Favorite pictures, Print order, Protect, Copy
-

Deleting Images in a Sequence

When the  button is pressed for images in a sequence, the images that are deleted vary depending on how the sequences are displayed.

- When the key picture is displayed:
 - **Current image:** All images in the displayed sequence are deleted.
 - **Erase selected images:** When a key picture is selected on the erase selected images screen (📖31), all images in that sequence are deleted.
 - **All images:** All images in the internal memory or on the memory card are deleted.
- When images in a sequence are displayed in full-frame playback mode:
 - **Current image:** The image currently displayed is deleted.
 - **Erase selected images:** Images that are selected in the sequence are deleted.
 - **Entire sequence:** All images in the displayed sequence are deleted.

Editing Images (Still Images)

Before Editing Images

You can easily edit images on this camera. Edited copies are saved as separate files. Edited copies are saved with the same shooting date and time as the original.



Restrictions on Image Editing

An image can be edited up to ten times.

Quick Effects: Changing Hue or Mood

Quick Effects Option	Description
Pop and Super vivid	Mainly enhances the color saturation.
Painting, High key, Toy camera effect 1, Toy camera effect 2, Low key, Cross process (red), Cross process (yellow), Cross process (green), and Cross process (blue)	Mainly adjusts hue and creates a different look for the image.
Photo illustration, Soft, Soft portrait, Fisheye, Cross screen, and Miniature effect	Processes images with a variety of effects.
High-contrast monochrome, Sepia, Cyanotype, and Selective color	Turns multicolor images into single color images. Selective color transforms all colors, except a specified color, to black and white.

- 1 Display the image to which you want to apply an effect in full-frame playback mode and press the **OK** button.



- 2 Use the multi selector **▲▼◀▶** to select the desired effect and press the **OK** button.

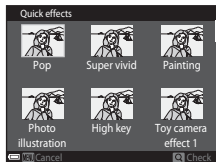

- Move the zoom control (**□**) toward **T** (**Q**) to switch to full-frame playback or **W** (**⊞**) to switch to thumbnail playback.
- To exit without saving the edited image, press the **MENU** button.



- 3 Select **Yes** and press the **OK** button.

- An edited copy is created.

Quick Retouch: Enhancing Contrast and Saturation



Press the  button (playback mode) → select an image → MENU button → Quick retouch →  button

Use the multi selector   to select the amount of effect applied and press the  button.

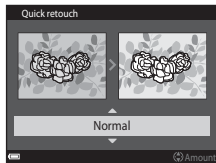
- The edited version is displayed on the right.
- To exit without saving the copy, press .



D-Lighting: Enhancing Brightness and Contrast



Press the  button (playback mode) → select an image → MENU button → D-Lighting →  button

Use the multi selector   to select **OK** and press the  button.

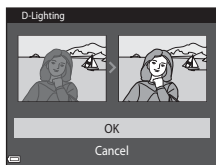
- The edited version is displayed on the right.
- To exit without saving the copy, select **Cancel** and press the  button.



Red-eye Correction: Correcting Red-eye When Shooting with the Flash

Press the  button (playback mode) → select an image → MENU button → Red-eye correction →  button

Preview the result and press the  button.

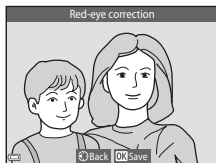

- To exit without saving the copy, press the multi selector .







Notes About Red-eye Correction

- Red-eye correction can only be applied to images when red-eye is detected.
- Red-eye correction can be applied to pets (dogs or cats) even if their eyes are not red.
- Red-eye correction may not produce the desired results in some images.
- In some rare cases, red-eye correction may be applied unnecessarily to other areas of the image.





Glamour Retouch: Enhancing Human Faces



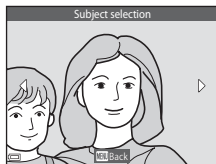









Press the  button (playback mode) → select an image → MENU button → Glamour retouch → 

1 Use the multi selector     to select the face that you want to retouch and press the  button.

- When only one face is detected, proceed to step 2.



2 Use   to select the effect, use   to select the effect level, and press the  button.

- You can simultaneously apply multiple effects. Adjust or check the settings for all effects before pressing the  button.
 -  (Small face),  (Skin softening),  (Powder),  (Glare reduction),  (Hide eye bags),  (Big eyes),  (Whiten eyes),  (Eye shadow),  (Mascara),  (Whiten teeth),  (Lipstick),  (Redden cheeks)
- Press the MENU button to return to the screen for selecting a person.

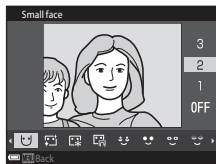

3 Preview the result and press the **OK** button.

- To change the settings, press **◀** to return to step 2.
- To exit without saving the edited image, press the **MENU** button.

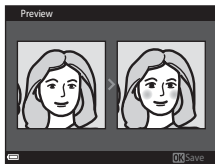

4 Select **Yes** and press the **OK** button.

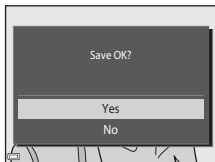

- An edited copy is created.









✓ Notes About Glamour Retouch

- Only one face at a time can be edited using the glamour retouch function.
- Depending upon the direction in which faces are looking, or the brightness of faces, the camera may be unable to accurately detect faces, or the glamour retouch function may not perform as expected.
- If no faces are detected, a warning is displayed and the screen returns to the playback menu.
- The glamour retouch function is available only for images captured at an ISO sensitivity of 1600 or lower, and the image size of 640 × 480 or larger.

Small Picture: Reducing the Size of an Image

Press the  button (playback mode) → select an image → MENU button → Small picture →  button

1 Use the multi selector   to select the desired copy size and press the  button.

- Images taken at an image mode setting of  **4608×2592** are saved at a size of 640 × 360, and images taken at an image mode setting of  **3456×3456** are saved at 480 × 480. Press the  button to proceed to step 2.

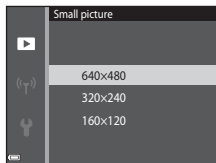

2 Select **Yes** and press the  button.

- An edited copy is created (compression ratio of approximately 1:16).

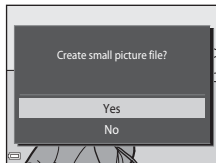

Crop: Creating a Cropped Copy

1 Move the zoom control to enlarge the image (📖66).

2 Refine copy composition and press the **MENU** button.

- Move the zoom control toward **T** (📏) or **W** (📐) to adjust the zoom ratio. Set a zoom ratio at which **MENU**:🗑️ is displayed.
- Use the multi selector **▲▼◀▶** to scroll the image so that only the portion to be copied is visible in the monitor.



3 Select **Yes** and press the **OK** button.

- An edited copy is created.

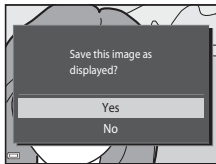

Image Size

Copies created with the small picture function or cropped to a size of 320 × 240 or smaller are displayed at a small size on the playback screen and cannot be cropped.

Cropping the Image in Its Current "Tall" Orientation

Use the **Rotate image** option (🔄59) to rotate the image so that it is displayed in landscape orientation. After cropping the image, rotate the cropped image back to "tall" orientation.

Connecting the Camera to a TV (Playback on a TV)

1 Turn off the camera and connect it to the TV.

- Make sure that the plugs are properly oriented. Do not insert or remove the plugs at an angle when connecting or disconnecting them.

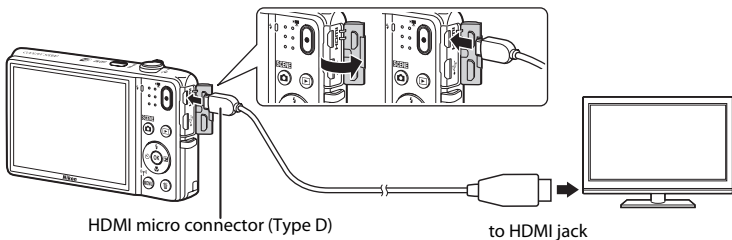

2 Set the TV's input to external video input.

- See the documentation provided with your TV for details.

3 Hold down the button to turn on the camera.

- Images are displayed on the TV.
- The camera monitor does not turn on.

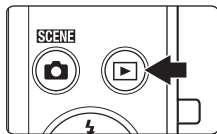

If Images Are Not Displayed on the TV

Make sure that **TV settings** (0084) in the setup menu conforms to the standard used by your TV.

Using a TV Remote Control (HDMI Device Control)

The remote control of an HDMI-CEC-compatible TV can be used to select images, start and pause movie playback, switch between full-screen playback mode and four-image thumbnail display, etc.

- Set the **HDMI device control** setting (0084) of **TV settings** to **On** (default setting) and then connect the camera and TV using an HDMI cable.
- Aim the remote control at the TV when operating it.

Connecting the Camera to a Printer (Direct Print)

Users of PictBridge-compatible printers can connect the camera directly to the printer and print images without using a computer.

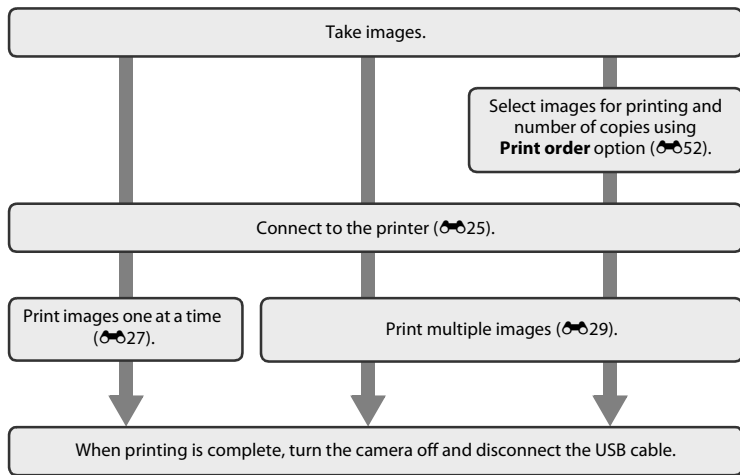

Connecting the Camera to a Printer

- 1 Turn off the camera.
- 2 Turn on the printer.
 - Check printer settings.
- 3 Connect the camera to the printer using the USB cable.
 - Make sure that the plugs are properly oriented. Do not insert or remove the plugs at an angle when connecting or disconnecting them.

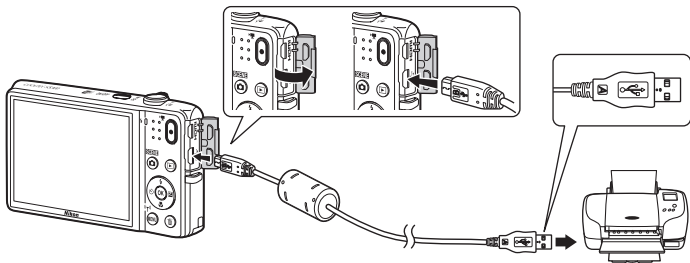

4 The camera is automatically turned on.

- The **PictBridge** startup screen (①) is displayed in the camera monitor, followed by the **Print selection** screen (②).

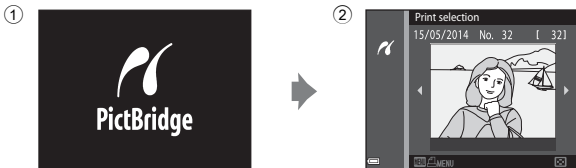

✔ If the PictBridge Startup Screen Is not Displayed

When **Auto** is selected for **Charge by computer** (p.85), it may be impossible to print images with direct connection of the camera to some printers. If the PictBridge startup screen is not displayed after the camera is turned on, turn the camera off and disconnect the USB cable. Set **Charge by computer** to **Off** and reconnect the camera to the printer.

Printing Images One at a Time

1 Use the multi selector to select the desired image and press the **OK** button.

- Move the zoom control toward **W** (📐) to switch to thumbnail playback or **T** (📺) to switch to full-frame playback.

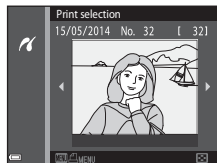

2 Use **▲▼** to select **Copies** and press the **OK** button.

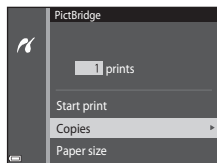

3 Select the desired number of copies (up to nine) and press the **OK** button.



4 Select **Paper size** and press the **OK** button.

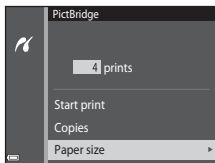

5 Select the desired paper size and press the **OK** button.

- To apply the paper size setting configured on the printer, select **Default** in the paper size option.
- The paper size options available on the camera vary depending on the printer that you use.

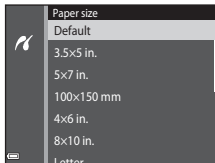

6 Select **Start print** and press the **OK** button.

- Printing starts.
- To cancel printing, press the **OK** button.

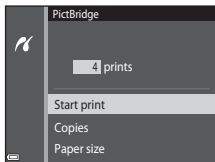

Printing Multiple Images

- 1 When the **Print selection** screen is displayed, press the **MENU** button.

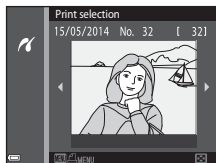

- 2 Use the multi selector ▲▼ to select **Paper size** and press the **OK** button.

- To exit the print menu, press the **MENU** button.

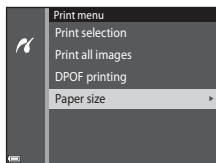

- 3 Select the desired paper size and press the **OK** button.

- To apply the paper size setting configured on the printer, select **Default** in the paper size option.
- The paper size options available on the camera vary depending on the printer that you use.

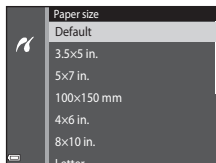

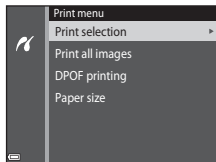

4 Select **Print selection**, **Print all images**, or **DPOF printing** and press the **OK** button.



Print selection

Select images (up to 99) and the number of copies (up to nine) of each.

- Use the multi selector **◀▶** to select images, and use **▲▼** to specify the number of copies to be printed.
- Images selected for printing are indicated by  and the numeral indicating the number of copies to be printed. If no copies have been specified for images, the selection is canceled.
- Move the zoom control toward **T** () to switch to full-frame playback or **W** () to switch to thumbnail playback.
- Press the **OK** button when setting is complete.
- When the screen shown on the right is displayed, select **Start print** and press the **OK** button to start printing.

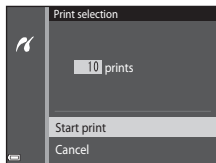

Print all images

One copy each of all images saved in the internal memory, or on the memory card, is printed.

- When the screen shown on the right is displayed, select **Start print** and press the **OK** button to start printing.

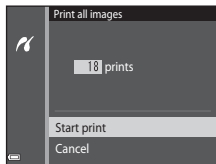

DPOF printing

Print images for which a print order was created using the **Print order** option (52).

- When the screen shown on the right is displayed, select **Start print** and press the **OK** button to start printing.

To view the current print order, select **View images** and press the **OK** button. To print images, press the **OK** button again.

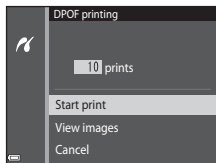

Editing Movies

The desired portions of a recorded movie can be saved as a separate file.

1 Play back the desired movie and pause at the start point of the portion that is to be extracted (📖75).

2 Use the multi selector ◀▶ to select 🎞️ in the playback controls, and then press the Ⓞ button.

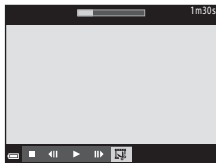

3 Use ▲▼ to select ✂️ (choose start point) in the editing controls.



- Use ◀▶ to move the start point.
- To cancel editing, select ↵ (return), and press the Ⓞ button.

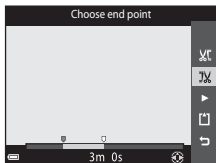

4 Use ▲▼ to select 🎞️ (choose end point).

- Use ◀▶ to move the end point.
- To preview the specified portion, select ▶ and then press the Ⓞ button. Press the Ⓞ button again to stop previewing.





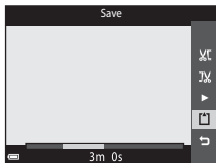

5 Use ▲▼ to select  (save) and press the  button.

- Follow the instructions on the screen to save the movie.



✓ Notes About Movie Editing

- Movies recorded using  **iFrame 720/30p** ( **iFrame 720/25p**) ( H.264) cannot be edited.
- Use a sufficiently charged battery to prevent the camera from turning off during editing. When the battery level indicator is , movie editing is not possible.
- A movie that was created by editing cannot be trimmed again.
- The actual trimmed portion of a movie may differ slightly from the portion selected using the start and end points.
- Movies cannot be trimmed so that they are less than two seconds long.

The Shooting Menu (for (Auto) Mode)

Image Mode (Image Size and Quality)

Enter shooting mode → MENU button → Image mode →  button

Select the combination of image size and compression ratio that is used when saving images. The higher the image mode setting, the larger the size at which it can be printed, and the lower the compression ratio, the higher the quality of the images, but the number of images that can be saved is reduced.

Option*	Compression ratio	Aspect ratio (horizontal to vertical)
16M* 4608×3456★	Approx. 1/4	4:3
16M 4608×3456 (default setting)	Approx. 1/8	4:3
8M 3264×2448	Approx. 1/8	4:3
4M 2272×1704	Approx. 1/8	4:3
2M 1600×1200	Approx. 1/8	4:3
VGA 640×480	Approx. 1/8	4:3
Hi-9 12M 4608×2592	Approx. 1/8	16:9
1:1 3456×3456	Approx. 1/8	1:1

* The total number of pixels captured, and the number of pixels captured horizontally and vertically.

Example: **16M 4608×3456** = approx. 16 megapixels, 4608 × 3456 pixels

Image Mode

- The image mode setting can also be changed in shooting modes other than auto. The changed setting is also applied to other shooting modes.
- Some functions cannot be used with other menu options (📖58).

Number of Images That Can Be Saved

- The approximate number of images that can be saved can be checked in the monitor when shooting (📖20).
- Note that due to JPEG compression, the number of images that can be saved may vary greatly depending on the image content, even when using memory cards with the same capacity and the same image mode setting. In addition, the number of images that can be saved may vary depending on the make of the memory card.
- If the number of exposures remaining is 10,000 or more, the number of exposures remaining display shows “9999”.

Printing Images at 1:1 Aspect Ratio







Change the printer setting to “Border” when printing images at a 1:1 aspect ratio. Some printers may not be able to print images at a 1:1 aspect ratio.

White Balance (Adjusting Hue)



Select  (auto) mode → MENU button → White balance →  button

Adjust white balance to suit the light source or weather conditions in order to make the colors in images match what you see with your eyes.

- Use **Auto** under most conditions. Change the setting when you want to adjust the hue of the image you are taking.

Option	Description
AUTO Auto (default setting)	White balance is automatically adjusted to suit lighting conditions.
PRE Preset manual	Use when the desired result is not achieved with Auto , Incandescent , etc. ( 37).
 Daylight	Use under direct sunlight.
 Incandescent	Use under incandescent lighting.
 Fluorescent	Use under fluorescent lighting.
 Cloudy	Use when taking images under overcast skies.
 Flash	Use with the flash.

Notes About White Balance

- Set the flash to  (off) when white balance is set to any setting other than **Auto** and **Flash** (47).
- Some functions cannot be used with other menu options (58).

Using Preset Manual

Use the procedure below to measure the white balance value under the lighting used during shooting.

1 Place a white or gray reference object under the lighting that will be used during shooting.

2 Use the multi selector ▲▼ to select **Preset manual** in the **White balance** menu, and press the **OK** button.

- The camera zooms in to the position for measuring white balance.

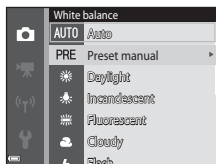

3 Select **Measure**.

- To apply the last measured value, select **Cancel** and press the **OK** button.

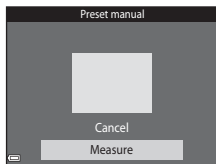

4 Frame the reference object in the measuring window.

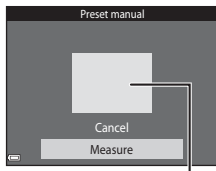

Measuring window



5 Press the button to measure the value.











- The shutter is released and measurement is complete. No image is saved.



Notes About Preset Manual

A value for flash lighting cannot be measured with **Preset manual**. When shooting using the flash, set **White balance** to **Auto** or **Flash**.

Continuous Shooting

Select  (auto) mode → MENU button → Continuous →  button

Option	Description
 Single (default setting)	One image is taken each time the shutter-release button is pressed.
 Continuous H	While the shutter-release button is held all the way down, images are captured continuously. <ul style="list-style-type: none">The frame rate for continuous shooting is about 8.6 fps and the maximum number of continuous shots is about 7 (when image mode is set to  4608×3456).
 Continuous L	While the shutter-release button is held all the way down, images are captured continuously. <ul style="list-style-type: none">The frame rate for continuous shooting is about 2 fps and the maximum number of continuous shots is about 7 (when image mode is set to  4608×3456).
 Pre-shooting cache	When the shutter-release button is pressed halfway, pre-shooting cache shooting begins. When the shutter-release button is pressed the rest of the way down, the camera saves the current image as well as the images captured immediately before the button is pressed ( 41). This function helps you to avoid missing the shot. <ul style="list-style-type: none">The frame rate for continuous shooting is about 11 fps and the maximum number of continuous shots is 5, including a maximum of two frames captured in the pre-shooting cache (when image mode is set to  4608×3456).
 120 Continuous H: 120 fps	Each time the shutter-release button is pressed all the way, images are captured at a high speed rate. <ul style="list-style-type: none">The frame rate for continuous shooting is about 120 fps and the maximum number of continuous shots is 50.Image mode is fixed at  (image size: 640 × 480 pixels).

Option	Description
 60 Continuous H: 60 fps	<p>Each time the shutter-release button is pressed all the way, images are captured at a high speed rate.</p> <ul style="list-style-type: none"> • The frame rate for continuous shooting is about 60 fps and the maximum number of continuous shots is 25. • Image mode is fixed at 1M (image size: 1280 × 960 pixels).
BSS BSS (Best Shot Selector)	<p>While the shutter-release button is held all the way down, the camera captures a series of up to ten images and automatically saves the sharpest image.</p> <p>Use when shooting a stationary subject in a place where flash photography is prohibited and camera shake is likely to occur.</p>
 Multi-shot 16	<p>Each time the shutter-release button is pressed all the way down, the camera captures a series of 16 images and saves it as a single image.</p> <ul style="list-style-type: none"> • The frame rate for continuous shooting is about 30 fps. • Image mode is fixed at 5M (image size: 2560 × 1920 pixels). • Digital zoom cannot be used. 

Notes About Continuous Shooting

- When a setting other than **Single** is selected, the flash cannot be used. Focus, exposure, and white balance are fixed at the values determined with the first image in each series.
- It may take some time to save the images after shooting.
- When ISO sensitivity increases, noise may appear in captured images.
- The frame rate for continuous shooting may vary depending upon the current image mode setting, the memory card used, or shooting condition.
- When using **Pre-shooting cache**, **Continuous H: 120 fps**, **Continuous H: 60 fps**, or **Multi-shot 16**, banding or variance in brightness or hue may occur in images that were captured under lighting that flickers at high speeds, such as fluorescent, mercury-vapor, or sodium-vapor lighting.
- Some functions cannot be used with other menu options ( 58).

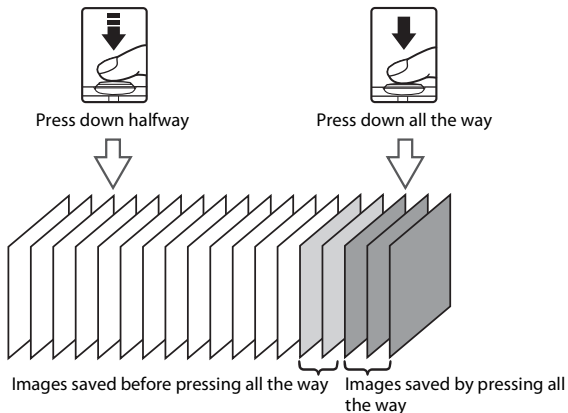

Pre-shooting Cache

When the shutter-release button is pressed halfway or all the way down, images are saved in the manner described below.



- The pre-shooting cache icon (📷) in the monitor glows green while the shutter-release button is pressed halfway.

ISO Sensitivity

Select  (auto) mode → MENU button → ISO sensitivity → 

Higher ISO sensitivity allows darker subjects to be captured. Additionally, even with subjects of similar brightness, images can be taken at faster shutter speeds, and blurring caused by camera shake and subject movement can be reduced.

- When higher ISO sensitivity is set, images may contain noise.

Option	Description
AUTO Auto (default setting)	Sensitivity is automatically selected from the range of ISO 125 to 1600.
ISO AUTO Fixed range auto	Select the range in which the camera automatically adjusts ISO sensitivity, from ISO 125-400 or ISO 125-800 .
125, 200, 400, 800, 1600, 3200, 6400	Sensitivity is locked at the specified value.



Notes About ISO Sensitivity

Some functions cannot be used with other menu options (58).





ISO Sensitivity Display on the Shooting Screen

- When **Auto** is selected, **ISO** is displayed if the ISO sensitivity automatically increases.
- When **Fixed range auto** is selected, the maximum value for ISO sensitivity is displayed.

Color Options

Select  (auto) mode → MENU button → Color options →  button



Make colors more vivid or save images in monochrome.

Option	Description
 Standard color (default setting)	Use for images exhibiting natural color.
 Vivid color	Use to achieve a vivid, “photoprint” effect.
 Black-and-white	Save images in black-and-white.
 Sepia	Save images in sepia tones.
 Cyanotype	Save images in cyan-blue monochrome.

Notes About Color Options









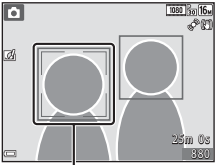
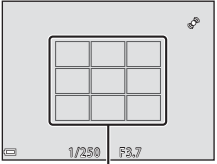

Some functions cannot be used with other menu options (58).

AF Area Mode

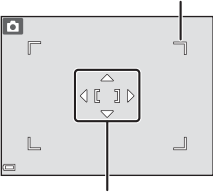
Select  (auto) mode → MENU button → AF area mode → 

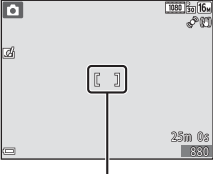
Use this option to determine how the camera selects the focus area for autofocus.

Option	Description
 Face priority	<p>When the camera detects a human face, it focuses on that face. See "Using Face Detection" (61) for more information.</p>  <p>Focus area</p> <p>When framing a composition with no human subjects or detected faces, the camera automatically selects one or more of the nine focus areas containing the subject closest to the camera when the shutter-release button is pressed halfway.</p>  <p>Focus areas</p>



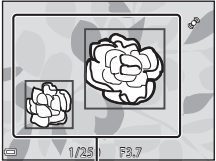

Option	Description	
<p>[] Manual</p>	<p>Use the multi selector  to move the focus area to where you want to focus.</p> <ul style="list-style-type: none"> To use the multi selector to configure the flash mode or other settings, press the  button. To return to moving the focus area, press the  button again. 	<p>Scope of movable focus area</p>  <p>Focus area</p>
<p>[] Center</p>	<p>The camera focuses on the subject in the center of the frame.</p>	 <p>Focus area</p>
<p> Subject tracking</p>	<p>Use this function to take images of moving subjects. Register the subject on which the camera focuses. The focus area automatically moves to track the subject. See "Using Subject Tracking" (47) for more information.</p>	

Option	Description
<p> Target finding AF (default setting)</p>	<p>When the camera detects the main subject, it focuses on that subject. See "Using Target Finding AF" (📖63) for more information.</p>  <p style="text-align: center;">Focus areas</p>



Notes About AF Area Mode

- When digital zoom is in effect, the camera focuses in the center of the frame regardless of the **AF area mode** setting.
- Some functions cannot be used with other menu options (📖58).

Using Subject Tracking

Select  (auto) mode → MENU button → AF area mode →  button →  Subject tracking →  button → MENU button

1 Register a subject.

- Align the subject that you want to track with the border in the center of the monitor and press the  button.
- When the subject is registered, a yellow border (focus area) is displayed around that subject and the camera begins tracking that subject.
- If the subject cannot be registered, the border glows red. Change the composition and try registering the subject again.
- To cancel subject registration, press the  button.
- If the camera can no longer track the registered subject, the focus area disappears. Register the subject again.

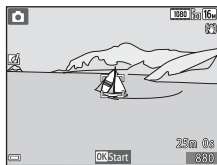

2 Press the shutter-release button fully to take the picture.

- If the shutter-release button is pressed while the focus area is not displayed, the camera focuses on the subject in the center of the frame.

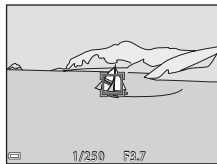

Notes About Subject Tracking

- If you perform operations such as zooming while the camera is tracking the subject, the registration is canceled.
- Subject tracking may not be possible in certain shooting conditions.

Autofocus Mode

Select  (auto) mode → MENU button → Autofocus mode →  button

Select how the camera focuses when shooting still images.





Option	Description
AF-S Single AF (default setting)	The camera focuses only when the shutter-release button is pressed halfway.
AF-F Full-time AF	The camera continues focusing even when the shutter-release button is not pressed halfway. The sound of lens drive movement is heard while the camera focuses.

Autofocus Mode for Movie Recording

Autofocus mode for movie recording can be set with **Autofocus mode** (68) in the movie menu.

Quick Effects

Select  (auto) mode → MENU button → Quick effects →  button

Option	Description
 On (default setting)	In  (auto) mode, press the  button immediately after releasing the shutter to display the effect selection screen and use the quick effects function ( 45).
Off	Disables the quick effects function (during shooting).

Notes About Quick Effects

Some functions cannot be used with other menu options (58).

The Smart Portrait Menu

- See “Image Mode (Image Size and Quality)” (📷34) for information about **Image mode**.





Skin Softening

Enter shooting mode → 📷 (shooting mode) button → 😊 Smart portrait → Ⓞ button
→ MENU button → Skin softening → Ⓞ button





Option	Description
⬆️ High	When the shutter is released, the camera detects one or more human faces (up to three), and processes the image to soften facial skin tones before saving the image. You can select the amount of effect that is applied.
⬆️ Normal (default setting)	
⬆️ Low	
Off	Turns skin softening off.

The effects of skin softening are not visible when framing images for shooting. Check the results in playback mode, after taking images.

Smile Timer

Enter shooting mode →  (shooting mode) button →  Smart portrait →  button
→ MENU button → Smile timer →  button





The camera detects human faces and then automatically releases the shutter whenever a smile is detected.

Option	Description
 On (single)	Whenever a smile is detected, the camera captures one image.
  On (continuous)	Whenever a smile is detected, the camera captures up to 5 images continuously and saves them all. The flash cannot be used.
 BSS On (BSS) (default setting)	Whenever a smile is detected, the camera captures up to 5 images continuously and saves the one that best captured the smile. The flash cannot be used.
Off	Turns the smile timer off.

Notes About Smile Timer

Some functions cannot be used with other menu options (58).

Blink Proof

Enter shooting mode →  (shooting mode) button →  Smart portrait →  button
→ MENU button → Blink proof →  button

Option	Description
 On	<p>The camera automatically releases the shutter twice with every shot and saves one image in which the subject's eyes are open.</p> <ul style="list-style-type: none">• If the camera saved an image in which the subject's eyes may have been closed, the dialog shown on the right is displayed for a few seconds.• The flash cannot be used.
Off (default setting)	Turns the blink proof off.

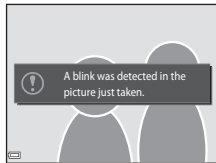

Notes About Blink Proof

Some functions cannot be used with other menu options (58).

The Playback Menu

- See “Editing Images (Still Images)” (📷14) for information about image editing functions.
- See “Favorite Pictures Mode” (📷6) for information about **Favorite pictures** and **Remove from favorites**.

Print Order (Creating a DPOF Print Order)

Press the  button (playback mode) → MENU button → Print order →  button

If you configure print order settings in advance, you can use them with the printing methods listed below.

- Taking the memory card to a digital photo lab that supports DPOF (Digital Print Order Format) printing.
- Inserting the memory card into a DPOF-compatible printer’s card slot.
- Connecting the camera to a PictBridge-compatible printer (📷24).

1 Use the multi selector ▲▼ to select **Select images** and press the button.

- In favorite pictures, auto sort, or list by date mode, the screen shown on the right is not displayed. Proceed to step 2.

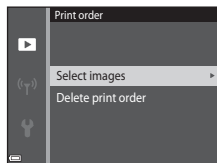

2 Select images (up to 99) and the number of copies (up to nine) of each.

- Use the multi selector ◀▶ to select images, and use ▲▼ to specify the number of copies to be printed.
- Images selected for printing are indicated by 🖨️ and the numeral indicating the number of copies to be printed. If no copies have been specified for images, the selection is canceled.
- Move the zoom control toward **T** (🔍) to switch to full-frame playback or **W** (🖼️) to switch to thumbnail playback.
- Press the **OK** button when setting is complete.

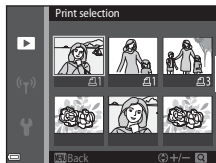

3 Select whether or not to print shooting date and shooting information.

- Select **Date** and press the **OK** button to print the shooting date on all images.
- Select **Info** and press the **OK** button to print the shutter speed and aperture value on all images.
- Lastly, select **Done** and press the **OK** button to complete the print order.

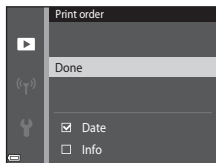

Notes About Print Order

When a print order is created in favorite pictures mode, auto sort mode, or list by date mode, the screen shown below is displayed if images other than those in the selected album, category, or shooting date have been marked for printing.

- **Yes:** Does not remove print markings from other images, and adds the current print order settings.
- **No:** Removes print markings from all other images, and uses only the current print order settings.

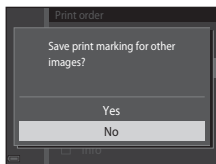

Favorite pictures mode or auto sort mode

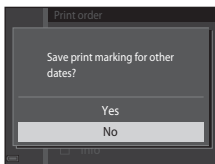

List by date mode

If the total number of the images in the print order exceeds 99 when the new settings are applied, the screen shown below is displayed.

- **Yes:** Removes print markings from all other images, and uses only the current print order settings.
- **Cancel:** Does not remove print markings from other images, and cancels the current print order settings.

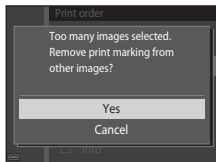

Favorite pictures mode or auto sort mode

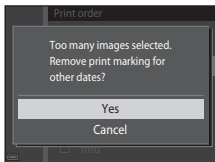

List by date mode

✔ Notes About Shooting Date and Shooting Information for Print Order

- Some printers may not be able to print the shooting date and shooting information.
- Shooting information is not printed when the camera is connected to a printer.
- The **Date** and **Info** settings are reset each time the **Print order** option is displayed.
- The shooting date is the date that was set on the camera when the image was captured.
- For images taken with the **Print date** (🔍78) option enabled, only the date and time imprinted at the time of shooting are printed, even if the **Print order** date option is enabled for the images.



📎 Canceling Existing Print Order

Select **Delete print order** in step 1 of "Print Order (Creating a DPOF Print Order)" (🔍52).

📎 More Information



See "Printing Images at 1:1 Aspect Ratio" (🔍35) for more information.

Slide Show

Press the  button (playback mode) → MENU button → Slide show →  button



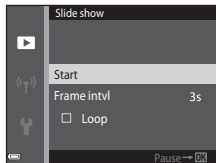

Play back images one by one in an automated “slide show.” When movie files are played back in the slide show, only the first frame of each movie is displayed.

1 Use the multi selector to select **Start** and press the .

- The slide show begins.
- To change the interval between images, select **Frame intvl**, press the , and specify the desired interval time before selecting **Start**.
- To repeat the slide show automatically, select **Loop** and press the  before selecting **Start**.
- The maximum playback time is up to about 30 minutes even if **Loop** is enabled.





2 End or restart the slide show.



- The screen shown on the right is displayed after the slide show ends or is paused. To exit the show, select  and then press the  button. To resume the slide show, select  and then press the .



Operations During Playback

- Use   to display the previous/next image. Press and hold to rewind/fast forward.
- Press the  button to pause or end the slide show.

Protect

Press the  button (playback mode) → MENU button → Protect →  button

The camera protects selected images from accidental deletion.

Select images to protect or cancel protection for previously protected images from the image selection screen (58).

Note that formatting the camera's internal memory or the memory card permanently deletes protected files (83).

The Image Selection Screen

When an image selection screen such as the one shown on the right is displayed while operating the camera, follow the procedures described below to select the images.



1 Use the multi selector ◀▶ to select an image.

- Move the zoom control (◻1) toward **T** (📷) to switch to full-frame playback or **W** (📑) to switch to thumbnail playback.
- Only one image can be selected for **Rotate image**, **Choose key picture**, and **Welcome screen**. Proceed to step 3.

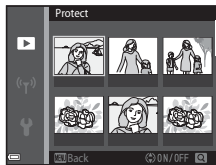

2 Use ▲▼ to select or deselect (or to specify the number of copies).

- When an image is selected, an icon is displayed below the image. Repeat steps 1 and 2 to select additional images.





3 Press the Ⓞ button to apply image selection.

- When **Selected images** is selected, a confirmation dialog is displayed. Follow the instructions displayed in the monitor.

Rotate Image

Press the  button (playback mode) → MENU button → Rotate image →  button

Specify the orientation in which saved images are displayed during playback. Still images can be rotated 90 degrees clockwise or 90 degrees counterclockwise.

Select an image from the image selection screen (58). When the Rotate image screen is displayed, press the multi selector  to rotate the image 90 degrees.

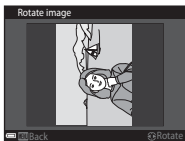

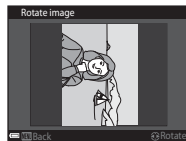

Rotate 90 degrees
counterclockwise



Rotate 90 degrees
clockwise





Press the  button to finalize display orientation, and save orientation information with the image.

Voice Memo

Press the  button (playback mode) → select an image → MENU button → Voice memo →  button

Voice memos can be recorded and attached to images.

Recording Voice Memos

- Press and hold the  button to record (up to about 20 seconds).
- Do not touch the microphone.
- During recording, **REC** and  flash in the monitor.
- The voice memo playback screen is displayed after recording ends. Press the  button to play back the voice memo.
- Delete the current voice memo before recording a new voice memo (61).
-  is displayed for images with a voice memo when in full-frame playback mode.





Playing Voice Memos

Select an image with  displayed before pressing the MENU button.

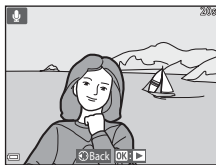
- Press the  button to play the voice memo. Press the button again to stop playback.
- Move the zoom control during playback to adjust playback volume.



Deleting Voice Memos



Press the  button while the screen described in "Playing Voice Memos" (60) is displayed.

When the confirmation dialog is displayed, use the multi selector   to select **Yes** and press the  button.

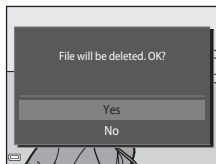

- To delete a voice memo for a protected image, the **Protect** setting must first be disabled.



Copy (Copy Between Internal Memory and Memory Card)

Press the  button (playback mode) → MENU button → Copy →  button

Copy images between the internal memory and a memory card.

- 1 Use the multi selector   to select a destination option to which images are copied and press the  button.

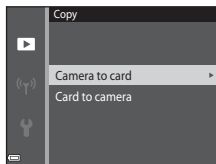

2 Select a copy option and press the **OK** button.

- If you choose the **Selected images** option, use the image selection screen to specify images (6658).

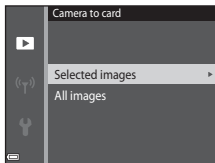

✓ Notes About Copying Images

- Only files in formats that this camera can record can be copied.
- Operation is not guaranteed with images captured with another make of camera or that have been modified on a computer.
- The **Print order** (6652) settings configured for images are not copied.
- Copied images or movies cannot be displayed in auto sort mode (6610).
- If an image added to an album (6606) is copied, the copied image is not added to the album.

📎 Notes About Copying Images in a Sequence

- If you select a key picture of a sequence in **Selected images**, all images in the sequence are copied.
- If you press the **MENU** button while images in a sequence are displayed, only the **Card to camera** copy option is available. All images in the sequence are copied if you select **Current sequence**.



📎 Copying to a Memory Card That Contains No Images

When the camera is switched to playback mode, **Memory contains no images.** is displayed. Press the **MENU** button to select **Copy**.

Sequence Display Options



Press the  button (playback mode) → MENU button → Sequence display options →  button

Select the method used to display images in the sequence (12).

Option	Description
 Individual pictures	Displays each image in a sequence individually.  is displayed on the playback screen.
 Key picture only (default setting)	Displays only the key picture for images in a sequence.

Settings are applied to all sequences, and the setting is saved in the camera's memory even if the camera is turned off.

Choose Key Picture

Press the  button (playback mode) → display a sequence for which you want to change the key picture → MENU button → Choose key picture →  button

Specify a different image in the sequence as the key picture.

- When the key picture selection screen is displayed, select an image (58).

The Movie Menu

Movie Options











Enter shooting mode → MENU button →  menu icon → Movie options →  button

Select the desired movie option to record.

Select normal speed movie options to record at normal speed, or HS movie options () to record in slow or fast motion.

- Memory cards (Class 6 or higher) are recommended for recording movies (:22).

Normal Speed Movie Options



Option (Image size/Frame rate ¹ , File format)	Image size	Aspect ratio (horizontal to vertical)
 1080/30p	1920×1080	16:9
 1080/25p (default setting)		
 1080/60i	1920×1080	16:9
 1080/50i		
 720/30p	1280×720	16:9
 720/25p		
 iFrame 720/30p ²	1280×720	16:9
 iFrame 720/25p ²		
 480/30p	640×480	4:3
 480/25p		

- The items and frame rate that can be set vary depending on the **Frame rate** setting in the movie menu (📷70).
- iFrame is a format supported by Apple Inc. iFrame files cannot be edited on this camera. When recording movies to the internal memory, recording may stop before the maximum movie length is reached.

HS Movie Options

Recorded movies are played back in fast or slow motion.

See “Recording Movies in Slow Motion and Fast Motion (HS Movie)” (📷66).

Option	Image size Aspect ratio (horizontal to vertical)	Description
 HS 480/4x	640×480 4:3	1/4-speed slow motion movies <ul style="list-style-type: none"> Max. recording time*: 10 seconds (playback time: 40 seconds)
 HS 720/2x	1280×720 16:9	1/2-speed slow motion movies <ul style="list-style-type: none"> Max. recording time*: 30 seconds (playback time: 1 minute)
 HS 1080/0.5x	1920×1080 16:9	2× speed fast motion movies <ul style="list-style-type: none"> Max. recording time*: 2 minutes (playback time: 1 minute)

- * While recording movies, the camera can be switched between normal speed movie recording and slow motion or fast motion movie recording.
The maximum recording time shown here refers only to the portion of the movie that is recorded in slow motion or fast motion.



Notes About HS Movie

- Sound is not recorded.
- Zoom position and focus are locked when movie recording starts.
- Some **Movie options** settings are not available when using certain special effects.

Recording Movies in Slow Motion and Fast Motion (HS Movie)

Enter shooting mode → MENU button →  menu icon → Movie options →  button



Movies recorded using HS movie can be played back in slow motion at 1/4 or 1/2 of the normal playback speed, or in fast motion at twice the normal playback speed.

1 Use the multi selector  to select an HS movie option () and press the  button.

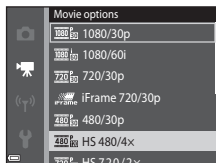
- After applying the option, press the MENU button to return to the shooting screen.



2 Press the  (movie-record) button to start recording.

- Movie recording starts at high speed when the **Open with HS footage** option in the movie menu is set to **On**, or at normal speed when it is set to **Off**.
- The camera switches between normal speed movie recording and HS movie recording each time the  button is pressed.
- The movie options icon changes when switching between HS movie recording and normal speed movie recording.
- When the maximum recording time for HS movies () is reached, the camera automatically switches to normal speed movie recording.

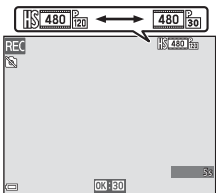

3 Press the  (movie-record) button to end recording.

Playing Back in Slow Motion and Fast Motion

When recording at normal speed:

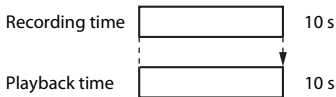

When recording at $\frac{480}{100}$ HS 480/4× ($\frac{480}{100}$ HS 480/4×):

Movies are recorded at 4× normal speed.

They are played back in slow motion at 4× slower speed.

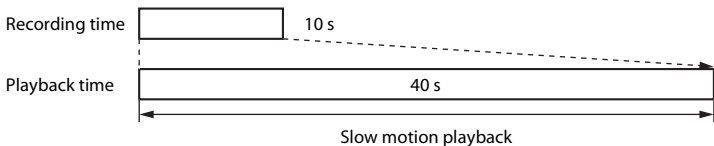

When recording at $\frac{1080}{100}$ HS 1080/0.5× ($\frac{1080}{100}$ HS 1080/0.5×):

Movies are recorded at 1/2 normal speed.

They are played back in fast motion at 2× faster speed.

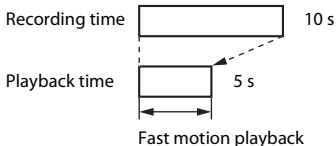

Open with HS Footage

Enter shooting mode → MENU button →  menu icon → Open with HS footage →  button



Set whether to start recording at high speed or normal speed when recording HS movies.

Option	Description
On (default setting)	Record HS movies when movie recording begins.
Off	Record normal speed movies when movie recording begins.

Autofocus Mode

Enter shooting mode → MENU button →  menu icon → Autofocus mode →  button

Set how the camera focuses in movie mode.

Option	Description
AF-S Single AF (default setting)	Focus is locked when the  (●  movie-record) button is pressed to start recording. Select this option when the distance between the camera and subject will remain fairly consistent during movie recording.
AF-F Full-time AF	The camera focuses continuously during movie recording. Select this option when the distance between the camera and subject will change significantly during recording. The sound of the camera focusing may be heard in the recorded movie. Use of Single AF is recommended to prevent the sound of the camera focusing from interfering with recording.



- When an HS movie option is selected in **Movie options**, the setting is fixed at **Single AF**.

Movie VR

Enter shooting mode → MENU button →  menu icon → Movie VR →  button



Select the vibration reduction setting used when recording movies.

Select **Off** when using a tripod to stabilize the camera during shooting.

Option	Description
 * On (hybrid) (default setting)	Performs optical compensation for camera shake using lens shift VR and simultaneously performs electronic VR using image processing. The angle of view (i.e., the area visible in the frame) becomes narrower.
 On	Performs compensation for camera shake using lens shift VR.
Off	Compensation is not performed.

- When an HS movie option is selected in **Movie options**, the setting is fixed at **Off**.

Notes About Movie VR

- The effects of camera shake may not be completely eliminated in some situations.
- In special effects mode, only lens shift VR is used to compensate for camera shake when **Movie options** is set to  **1080/60i** ( **1080/50i**), even if **Movie VR** is set to **On (hybrid)**.

Wind Noise Reduction

Enter shooting mode → MENU button →  menu icon → Wind noise reduction →  button

Set whether or not to reduce wind noise during movie recording.

Option	Description
 On	Reduces the sound produced when wind passes over the microphone. Other sounds may become difficult to hear during playback.
Off (default setting)	Wind noise reduction is not enabled.

- When an HS movie option is selected in **Movie options**, the setting is fixed at **Off**.

Frame Rate

Enter shooting mode → MENU button →  menu icon → Frame rate →  button

Select the frame rate used when recording movies. When the frame rate setting is switched, the movie frame rates that can be set in **Movie options** (64) change.

- **30 fps (30p/60i)** is suited for playback on a TV using the NTSC standard, and **25 fps (25p/50i)** is suited for playback on a TV using the PAL standard.

The Wi-Fi Options Menu

Press the **MENU** button → “T” menu icon →  button

Configure the Wi-Fi (wireless LAN) settings to connect the camera and a smart device.

Option	Description
Connect to smart device	Select when wirelessly connecting the camera and a smart device. See “Using the Wi-Fi (Wireless LAN) Function” (📖79) for more information.
Disable Wi-Fi	Select to terminate the wireless connection between the camera and a smart device. See “Using the Wi-Fi (Wireless LAN) Function” (📖79) for more information.
Options	SSID: Change the SSID. The SSID configured here is displayed on the smart device. Set a 1- to 24-character alphanumeric SSID.
	Auth./encryp.: Select whether or not to encrypt the communications between the camera and the connected smart device. Communications are not encrypted when Open (default setting) is selected.
	Password: Set the password. Set an 8- to 16-character alphanumeric password.
	Channel: Select the channel used for wireless connections.
Current settings	Display the current settings.
Restore default settings	Restore the Wi-Fi settings to their default values. The wireless connection is terminated if this option is performed while Wi-Fi is connected.

Operating the Text Input Keyboard

- Use the multi selector ▲▼◀▶ to select alphanumeric characters. Press the **OK** button to enter the selected character in the text field and move the cursor to the next space.
- To move the cursor in the text field, select ← or → on the keyboard, and press the **OK** button.
- To delete one character, press the **⌫** button.
- To apply the setting, select ↵ on the keyboard and press the **OK** button.

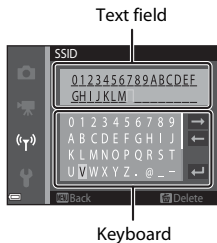



The Setup Menu

Welcome Screen

Press the MENU button →  menu icon → Welcome screen →  button

Configure the welcome screen that is displayed when you turn on the camera.

Option	Description
None (default setting)	Does not display the welcome screen.
COOLPIX	Displays a welcome screen with the COOLPIX logo.
Select an image	<p>Displays an image selected for the welcome screen.</p> <ul style="list-style-type: none">• The image selection screen is displayed. Select an image () and press the  button.• Because a copy of the selected image is saved in the camera, it will be displayed when the camera is turned on, even if the original image is deleted.• An image cannot be selected if its aspect ratio is different from that of the screen, or if the image size is extremely small after the small picture or crop function is applied.

Time Zone and Date

Press the MENU button → Y menu icon → Time zone and date → OK button

Set the camera clock.

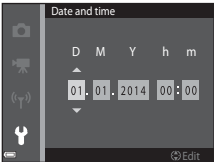
Option	Description
Date and time	<ul style="list-style-type: none">• Select a field: Press the multi selector ◀▶ (changes between D, M, Y, hour, and minute).• Edit the date and time: Press ▲▼.• Apply the setting: Select the minute setting and press the OK button. 
Date format	Select Year/Month/Day , Month/Day/Year , or Day/Month/Year .
Time zone	<p>Set time zone and daylight saving time.</p> <ul style="list-style-type: none">• When Travel destination (📍) is set after having set the home time zone (🏠), the time difference between the travel destination and the home time zone is automatically calculated, and the date and time are saved for the selected region.

Setting the Time Zone

- 1 Use the multi selector ▲▼ to select **Time zone** and press the OK button.

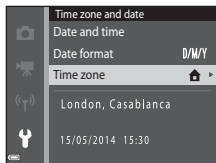

2 Select Home time zone or Travel destination and press the button.



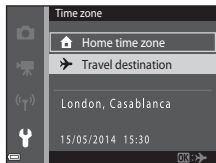

- The date and time displayed in the monitor changes depending on whether the home time zone or travel destination is selected.

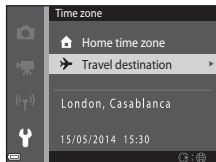

3 Press .



4 Use to select the time zone.

- Press  to enable daylight saving time function, and  is displayed. Press  to disable the daylight saving time function.
- Press the  button to apply the time zone.
- If the correct time is not displayed for the home or travel destination time zone setting, set the appropriate time in **Date and time**.

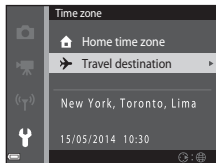
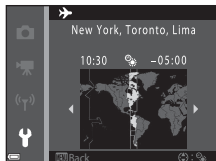









Monitor Settings

Press the MENU button →  menu icon → Monitor settings →  button

Option	Description
Photo info	Set whether or not to display information in the monitor.
Image review	This setting determines whether or not the captured image is displayed immediately after shooting. <ul style="list-style-type: none">• Default setting: On
Brightness	Select from five settings. <ul style="list-style-type: none">• Default setting: 3

Photo Info

	Shooting mode	Playback mode
Show info		
Auto info (default setting)	Current settings and operation guide are displayed as in Show info . If no operations are performed for a few seconds, the information is hidden as in Hide info . Information is displayed again when the next operation is performed.	
Hide info		

	Shooting mode	Playback mode
Framing grid+auto info	 <p>In addition to information shown with Auto info, a framing grid is displayed to help frame images. The framing grid is not displayed when recording movies.</p>	 <p>The current settings or operation guide is displayed as in Auto info.</p>
Movie frame+auto info	 <p>In addition to information shown with Auto info, a frame is displayed before recording begins that represents the area that will be captured when recording movies. The movie frame is not displayed when recording movies.</p>	 <p>The current settings or operation guide is displayed as in Auto info.</p>

✓ Notes About Monitor Settings

When **Quick effects** (48) is set to **On** while shooting still images, the captured image is displayed after shooting, regardless of the **Image review** setting.

Print Date (Imprinting Date and Time)

Press the **MENU** button → **Y** menu icon → **Print date** → **OK** button

The shooting date and time can be imprinted on the images when shooting, allowing the information to be printed even from printers that do not support date printing (📷55).



Option	Description
DATE Date	Date is imprinted on images.
DATE ON Date and time	Date and time are imprinted on images.
Off (default setting)	Date and time are not imprinted on images.

✔ Notes About Print Date

- Imprinted dates form a permanent part of image data and cannot be deleted. The date and time cannot be imprinted on images after they have been captured.
- The date and time cannot be imprinted in the following situations:
 - When using **Night portrait** (when **Hand-held** is selected), **Night landscape** (when **Hand-held** is selected), or **Easy panorama** scene mode
 - When the continuous shooting setting (📷39) is set to **Pre-shooting cache**, **Continuous H: 120 fps**, or **Continuous H: 60 fps**
 - When shooting movies
- The imprinted date and time may be difficult to read when using a small image size.

Photo VR

Press the **MENU** button →  menu icon → Photo VR →  button

Select the vibration reduction setting used when shooting still images.
Select **Off** when using a tripod to stabilize the camera during shooting.

Option	Description
 On (default setting)	Performs compensation for camera shake.
Off	Compensation is not performed.





Notes About Photo VR

- After turning on the camera or after switching from playback mode to shooting mode, wait for the shooting mode screen to be displayed completely before taking images.
- Images displayed in the camera monitor immediately after shooting may be displayed blurry.
- The effects of camera shake may not be completely eliminated in some situations.

Motion Detection

Press the **MENU** button →  menu icon → Motion detection →  button

Enable motion detection to reduce the effects of subject movement and camera shake when shooting still images.

Option	Description
 Auto (default setting)	Motion detection is enabled with some shooting modes or settings, when  is displayed on the shooting screen. When the camera detects subject movement or camera shake,  turns green, and the ISO sensitivity and shutter speed are automatically increased to reduce blurring. <ul style="list-style-type: none">• Set ISO sensitivity () to Auto in  (auto) mode.
Off	Motion detection is disabled.

Notes About Motion Detection

- Motion detection may be unable to eliminate the effects of subject movement and camera shake in some situations.
- Motion detection may be disabled if the subject exhibits significant movement or is too dark.
- The images captured using motion detection may be somewhat “grainy” in appearance.



AF Assist

Press the MENU button →  menu icon → AF assist →  button

Enable or disable the AF-assist illuminator which assists autofocus operation.

Option	Description
AUTO Auto (default setting)	The AF-assist illuminator automatically lights up when the subject is dimly lit. The illuminator has a range of about 2 m (6 ft 6 in.) at the maximum wide-angle position and about 1.5 m (4 ft 11 in.) at the maximum telephoto position. <ul style="list-style-type: none">Note that for some scene modes or focus areas, the AF-assist illuminator may not light.
Off	The AF-assist illuminator does not light.





Digital Zoom

Press the MENU button →  menu icon → Digital zoom →  button

Option	Description
On (default setting)	Digital zoom is enabled.
Off	Digital zoom is disabled.

Notes About Digital Zoom

Digital zoom cannot be used in the following situations:

- When **Portrait**, **Night portrait**, **Night landscape**, **Backlighting** (when **HDR** is set to **ON**), **Easy panorama**, or **Pet portrait** is selected in scene mode
- When smart portrait mode is selected
- When **Continuous** () is set to **Multi-shot 16** in  (auto) mode
- When **AF area mode** () is set to **Subject tracking** in  (auto) mode

Sound Settings

Press the **MENU** button → **Y** menu icon → Sound settings → **OK** button

Option	Description
Button sound	When On (default setting) is selected, the camera produces one beep when operations are performed, two beeps when focus is acquired on the subject, and three beeps when an error occurs. The start-up sound is also produced. <ul style="list-style-type: none">• Sounds are disabled when using Pet portrait scene mode.
Shutter sound	When On (default setting) is selected, the shutter sound is produced when the shutter is released. <ul style="list-style-type: none">• The shutter sound is not produced when using continuous shooting mode, when recording movies, or when using Pet portrait scene mode.

Auto Off

Press the **MENU** button → **Y** menu icon → Auto off → **OK** button

Set the amount of time that elapses before the camera enters standby mode (📖21). You can select **30 s**, **1 min** (default setting), **5 min**, or **30 min**.

Setting the Auto Off Function

The time that passes before the camera enters standby mode is fixed in the following situations:

- When a menu is displayed: 3 minutes (when auto off is set to **30 s** or **1 min**)
- When shooting using **Pet portrait auto release**: 5 minutes (when auto off is set to **30 s** or **1 min**)
- When shooting using **Smile timer**: 5 minutes (when auto off is set to **30 s** or **1 min**)
- When the AC adapter EH-62G is connected: 30 minutes
- When a USB cable or HDMI cable is connected: 30 minutes

Format Memory/Format Card

Press the MENU button →  menu icon → Format memory/Format card →  button

Use this option to format the internal memory or a memory card.

Formatting the internal memory or memory cards permanently deletes all data. Data that has been deleted cannot be recovered. Make sure to transfer important images to a computer before formatting.

- Do not turn the camera off or open the battery-chamber/memory card slot cover during formatting.

Formatting the Internal Memory

Remove the memory card from the camera. The **Format memory** option is displayed in the setup menu.

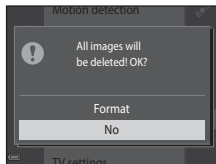

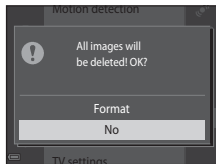

Formatting a Memory Card

Insert a memory card in the camera. The **Format card** option is displayed in the setup menu.





Language

Press the **MENU** button →  menu icon → Language →  button

Select a language for display of camera menus and messages.

TV Settings

Press the **MENU** button →  menu icon → TV settings →  button



Adjust settings for connection to a TV.

Option	Description
HDMI	Select a resolution for HDMI output. When Auto (default setting) is selected, the option best suited to the TV to which the camera is connected is automatically selected from 480p , 720p , or 1080i .
HDMI device control	When On (default setting) is selected, the HDMI-CEC-compatible TV's remote control can be used to control the camera during playback ( 23).

HDMI and HDMI-CEC

HDMI (High-Definition Multimedia Interface) is a multimedia interface. HDMI-CEC (HDMI-Consumer Electronics Control) allows compatible devices to inter-operate.

Charge by Computer

Press the MENU button →  menu icon → Charge by computer →  button

Option	Description
AUTO Auto (default setting)	When the camera is connected to a computer that is running (📖83), the battery inserted into the camera is automatically charged using power supplied by the computer.
Off	The battery inserted into the camera is not charged when the camera is connected to a computer.

Notes About Charging with a Computer

- When connected to a computer, the camera automatically turns on and starts charging. If the camera is turned off, charging stops.
- About 3 hours are required to charge a fully exhausted battery. Charging time increases when images are transferred while the battery is charging.
- The camera turns off automatically if there is no communication with the computer for 30 minutes after the battery has finished charging.

When the Charge Lamp Quickly Flashes Green

Charging cannot be performed, possibly due to one of the reasons described below.

- The ambient temperature is not suited to charging. Charge the battery indoors with an ambient temperature of 5°C to 35°C (41°F to 95°F).
- The USB cable is not connected correctly, or the battery is faulty. Make sure the USB cable is connected correctly and replace the battery if necessary.
- The computer is in sleep mode and is not supplying power. Wake up the computer.
- The battery cannot be charged because the computer cannot supply power to the camera due to the computer's settings or its specifications.

Blink Warning

Press the **MENU** button → **Y** menu icon → **Blink warning** → **OK** button

Select whether or not the camera detects human subjects that have blinked using face detection (📖61) when shooting in the following modes:

- **SR** (scene auto selector) mode (📖32)
- **Portrait** or **Night portrait** scene mode (📖34)
- **📷** (auto) mode (when **Face priority** (🔗44) is selected for AF area mode option)

Option	Description
On	When one or more human subjects may have blinked in an image captured using face detection, the Did someone blink? screen is displayed in the monitor. Check the image and determine whether or not another image should be captured.
Off (default setting)	Blink warning is disabled.

The Blink Warning Screen

Faces detected by the blink warning are displayed inside a border.

The operations described below are available.

- To enlarge the face: Move the zoom control toward **T** (🔍). If more than one face is detected, use the multi selector (◀▶) to select the desired face.
- To switch to full-frame playback: Move the zoom control toward **W** (📷).





If you press the **OK** button, or if no operations are performed for a few seconds, the camera returns to shooting mode.

✓ Notes About Blink Warning

- The blink warning is disabled at continuous settings other than **Single** (🔗39).
- The blink warning may not function properly in some shooting conditions.

Eye-Fi Upload

Press the **MENU** button →  menu icon → Eye-Fi upload →  button





Option	Description
 Enable (default setting)	Upload images created by the camera to a preselected destination.
 Disable	Images are not uploaded.

Notes About Eye-Fi Cards



- Note that images will not be uploaded if signal strength is insufficient even if **Enable** is selected.
- Remove your Eye-Fi card from the camera where wireless devices are prohibited. Signals may be transmitted even if **Disable** is selected.
- Refer to the instruction manual of your Eye-Fi card for more information. In the event of malfunction, contact the card manufacturer.
- The camera can be used to turn Eye-Fi cards on and off, but may not support other Eye-Fi functions.
- The camera is not compatible with the Endless Memory function. When it is set on a computer, disable the function. If the Endless Memory function is enabled, the number of images taken may not be displayed correctly.
- Eye-Fi cards are for use only in the country of purchase. Observe all local laws concerning wireless devices.
- Leaving the setting as **Enable** will result in the battery being depleted in a shorter period of time.

Eye-Fi Communication Indicator

The communication status of the Eye-Fi card in the camera can be confirmed in the monitor ( 7).

- : **Eye-Fi upload** is set to **Disable**.
-  (lights): Eye-Fi upload enabled; waiting to begin upload.
-  (flashes): Eye-Fi upload enabled; uploading data.
- : Eye-Fi upload enabled but no images available for upload.
- : An error occurred. The camera cannot control the Eye-Fi card.

Reset All

Press the **MENU** button →  menu icon → **Reset all** →  button

When **Reset** is selected, the camera's settings are restored to their default values.

- Some settings, such as **Time zone and date** or **Language**, are not reset.
- The wireless connection is terminated if this option is performed while Wi-Fi is connected.



Resetting File Numbering

To reset file numbering to "0001", delete all images saved in the internal memory or on the memory card (📖30) before selecting **Reset all**.

Firmware Version





Press the **MENU** button →  menu icon → **Firmware version** →  button







View the current camera firmware version.











- The firmware version cannot be displayed while Wi-Fi is connected.





Error Messages









Refer to the table below if an error message is displayed.

Display	Cause/Solution	
Battery temperature is elevated. The camera will turn off. The camera will turn off to prevent overheating.	The camera turns off automatically. Wait until the camera or battery temperature has cooled before resuming use.	–
Memory card is write protected.	The write-protect switch is in the “lock” position. Slide the write-protect switch to the “write” position.	–
This card cannot be used.	An error occurred while accessing the memory card. <ul style="list-style-type: none">• Use an approved card.• Check that the terminals are clean.• Confirm that the memory card is correctly inserted.	14,  22
This card cannot be read.		
Card is not formatted. Format card?	The memory card has not been formatted for use in the camera. Formatting deletes all data saved on the memory card. If you need to keep copies of any images, make sure to select No and save the copies to a computer or other medium before formatting the memory card. Select Yes and press the  button to format the memory card.	 5

Display	Cause/Solution	
Not available if Eye-Fi card is locked.	The write-protect switch of the Eye-Fi card is in the "lock" position.	–
	An error occurred while accessing the Eye-Fi card. <ul style="list-style-type: none"> • Check that the terminals are clean. • Confirm that the Eye-Fi card is correctly inserted. 	14
Out of memory.	Delete images or insert a new memory card.	14, 30, 76
Image cannot be saved.	An error occurred while saving the image. Insert a new memory card or format the internal memory or memory card.	 83
	The camera has run out of file numbers. Insert a new memory card or format the internal memory or memory card.	 83
	The image cannot be used for the welcome screen.	 73
	There is insufficient space to save the copy. Delete images from the destination.	30
Album is full. No further pictures can be added.	200 images have already been added to the album. <ul style="list-style-type: none"> • Remove some images from the album. • Add to other albums. 	 8  6
Sound file cannot be saved.	A voice memo cannot be attached to this image. <ul style="list-style-type: none"> • Voice memos cannot be attached to movies. • Select an image captured with this camera. 	–

Display	Cause/Solution	
Image cannot be modified.	Select images that support the editing function.	 14,  14
Cannot record movie.	A time-out error occurred while saving the movie on the memory card. Select a memory card with a faster write speed.	71,  22
Memory contains no images.	There are no images in the internal memory or on the memory card. <ul style="list-style-type: none"> Remove the memory card from the camera to play back images in the camera's internal memory. To copy the images saved in the camera's internal memory to the memory card, press the MENU button to select Copy in the playback menu. 	15  61
	No images have been added to the selected album.	 6,  7
	No images are contained in the category selected in auto sort mode.	 10
File contains no image data.	The file was not created or edited with this camera. The file cannot be viewed on this camera.	-
This file cannot be played back.	View the file using a computer or the device used to create or edit this file.	-
All images are hidden.	There are no images available for a slide show, etc.	 56
This image cannot be deleted.	The image is protected. Disable protection.	 57

Display	Cause/Solution	
No access.	The camera could not receive the signal from the smart device. Select Connect to smart device in the Wi-Fi options menu, and establish the wireless connection again.	81,  71
Could not connect.	The camera failed to establish the connection while receiving the signals from the smart device. Set a different channel in Channel under Options in the Wi-Fi options menu, and establish the wireless connection again.	81,  71
Wi-Fi connection terminated.	A cable was connected to the camera while the camera and smart device were wirelessly connected, the battery level became low, or the connection was aborted due to poor connectivity. Disconnect the cable and establish the wireless connection again.	81,  71
Lens error	A lens error occurred. Turn the camera off and then on again. If the error persists, contact your retailer or Nikon-authorized service representative.	20
Communications error	An error occurred while communicating with the printer. Turn the camera off and reconnect the USB cable.	 25
System error	An error occurred in the camera's internal circuitry. Turn the camera off, remove and reinsert the battery, and turn the camera on. If the error persists, contact your retailer or Nikon-authorized service representative.	10, 20

Display	Cause/Solution	
Printer error: check printer status.	After solving the problem, select Resume and press the  button to resume printing.*	–
Printer error: check paper.	Load the specified size of paper, select Resume , and press the  button to resume printing.*	–
Printer error: paper jam.	Remove the jammed paper, select Resume , and press the  button to resume printing.*	–
Printer error: out of paper.	Load the specified size of paper, select Resume , and press the  button to resume printing.*	–
Printer error: check ink.	There is a problem with the printer's ink. Check the ink, select Resume , and press the  button to resume printing.*	–
Printer error: out of ink.	Replace the ink cartridge, select Resume , and press the  button to resume printing.*	–
Printer error: file corrupt.	There is a problem with the image file to be printed. Select Cancel and press the  button to cancel printing.	–

* See the documentation provided with your printer for further guidance and information.

File Names

Images, movies, or voice memos are assigned file names as follows.

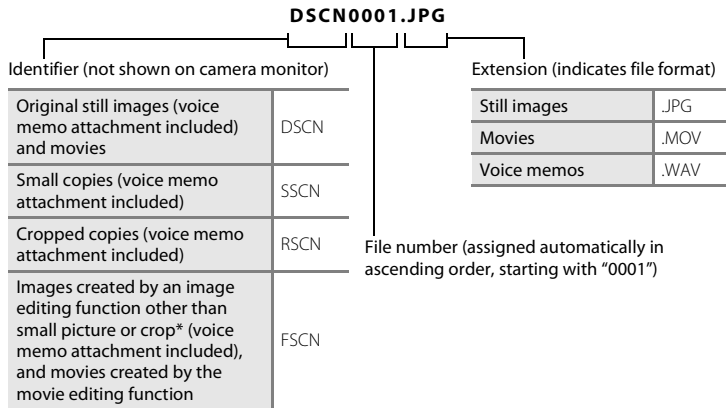

* Including images edited using the quick effects function (📖45) in 📷 (auto) mode

- Voice memo file names have the same identifier and file number as the image to which the voice memo is attached.

Optional Accessories

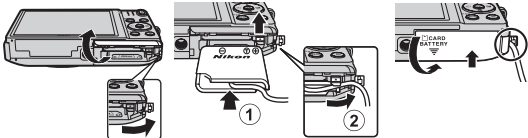
Battery charger	Battery Charger MH-66 (Charging time when no charge remains: Approx. 1 h 50 min)
AC adapter	<p data-bbox="327 188 664 208">AC Adapter EH-62G (connect as shown)</p>  <p data-bbox="327 398 930 515">Make sure that the power connector cord has been properly aligned in power connector and battery chamber grooves before closing the battery-chamber/memory card slot cover. If part of the cord runs out of the grooves, the cover or cord may be damaged when the cover is closed.</p>

Availability may vary with country or region.
See our website or brochures for the latest information.



A series of ten horizontal dashed lines spanning the width of the page, intended for handwriting practice.



Technical Notes and Index

Caring for the Product	2
The Camera.....	2
The Battery.....	3
Charging AC Adapter.....	4
Memory Cards.....	5
Cleaning and Storage	6
Cleaning.....	6
Storage.....	6
Troubleshooting	7
Specifications	17
Approved Memory Cards.....	22
Index	25

Caring for the Product

The Camera

To ensure continued enjoyment of this Nikon product, observe the precautions described below in addition to the warnings in “For Your Safety” (📖viii-x) when using or storing the device.

✔ Do Not Drop

The product may malfunction if subjected to strong shock or vibration.

✔ Handle the Lens and All Moving Parts with Care

Do not apply force to the lens, lens cover, monitor, memory card slot, or battery chamber. These parts are easily damaged. Applying force to the lens cover could result in camera malfunction or damage to the lens. Should the monitor break, care should be taken to avoid injury caused by broken glass and to prevent the liquid crystal from the display touching the skin or entering the eyes or mouth.

✔ Keep Dry

The device will be damaged if immersed in water or subjected to high humidity.

✔ Avoid Sudden Changes in Temperature

Sudden changes in temperature, such as when entering or leaving a heated building on a cold day, can cause condensation to form inside the device. To prevent condensation, place the device in a carrying case or a plastic bag before exposing it to sudden changes in temperature.

✔ Keep Away from Strong Magnetic Fields

Do not use or store this device in the vicinity of equipment that generates strong electromagnetic radiation or magnetic fields. Strong static charge or the magnetic fields produced by equipment such as radio transmitters could interfere with the monitor, damage data saved on the memory card, or affect the product's internal circuitry.

Do Not Point the Lens at Strong Light Sources for Extended Periods

Avoid pointing the lens at the sun or other strong light sources for extended periods when using or storing the camera. Intense light may cause deterioration of the image sensor, producing a white blur effect in photographs.

Turn the Product Off Before Removing or Disconnecting the Power Source or Memory Card

Do not remove the battery while the product is on, or while images are being saved or deleted. Forcibly cutting power in these circumstances could result in loss of data or in damage to product memory or internal circuitry.

Notes About the Monitor

- Monitors and electronic viewfinders are constructed with extremely high precision; at least 99.99% of pixels are effective, with no more than 0.01% being missing or defective. Hence while these displays may contain pixels that are always lit (white, red, blue, or green) or always off (black), this is not a malfunction and has no effect on images recorded with the device.
- Images in the monitor may be difficult to see under bright lighting.
- The monitor is lit by an LED backlight. Should the monitor begin to dim or flicker, contact your Nikon-authorized service representative.

The Battery

Be sure to read and follow the warnings in “For Your Safety” (viii-x) before use.

- Check the battery level before using the camera and replace or charge the battery if necessary. Do not continue charging once the battery is fully charged as this will result in reduced battery performance. Whenever possible, carry a fully charged spare battery when taking images on important occasions.
- Do not use the battery at ambient temperatures below 0°C (32°F) or above 40°C (104°F).
- Charge the battery indoors with an ambient temperature of 5°C to 35°C (41°F to 95°F) before use.
- When charging the battery inserted into this camera using the Charging AC Adapter or a computer, the battery is not charged at battery temperatures below 0°C (32°F) or above 45°C (113°F).

- Note that the battery may become hot during use; wait for the battery to cool before charging. Failure to observe these precautions could damage the battery, impair its performance, or prevent it from charging normally.
- On cold days, the capacity of batteries tends to decrease. If an exhausted battery is used at a low temperature, the camera will not turn on. Be sure that the battery is fully charged before heading outside to take images in cold weather. Keep spare batteries in a warm place and exchange as necessary. Once warmed, a cold battery may recover some of its charge.
- Dirt on the battery terminals can prevent the camera from functioning. Should the battery terminals become dirty, wipe them off with a clean, dry cloth before use.
- If the battery will not be used for some time, insert it in the camera and completely exhaust it before removing it for storage. The battery should be stored in a cool location with an ambient temperature of 15°C to 25°C (59°F to 77°F). Do not store the battery in hot or extremely cold locations.
- Always remove the battery from the camera or optional battery charger when it is not being used. When inserted, minute amounts of current are drawn from the battery even when not in use. This may result in excessive draining of the battery and complete loss of function. Turning the camera on or off while the battery is exhausted can result in reduced battery life.
- Recharge the battery at least once every six months and completely exhaust it before returning it to storage.
- After removing the battery from the camera or optional battery charger, put the battery in a plastic bag, etc. in order to insulate it and store it in a cool place.
- A marked drop in the time a fully charged battery retains its charge, when used at room temperature, indicates that the battery needs to be replaced. Purchase a new EN-EL19 battery.
- Replace the battery when it no longer holds a charge. Used batteries are a valuable resource. Please recycle used batteries in accordance with local regulations.

Charging AC Adapter

Be sure to read and follow the warnings in “For Your Safety” (□viii-x) before use.

- The Charging AC Adapter EH-71P is for use only with compatible devices. Do not use with another make or model of device.
- Do not use a USB cable other than the UC-E21. Using a USB cable other than the UC-E21 could result in overheating, fire or electric shock.

- The EH-71P is compatible with AC 100-240 V, 50/60 Hz electrical outlets. When using in other countries, use a plug adapter (commercially available) as necessary. For more information about plug adapters, consult your travel agency.
- Do not, under any circumstances, use another make or model of AC adapter other than Charging AC Adapter EH-71P, and do not use a commercially available USB-AC adapter or a battery charger for a mobile phone. Failure to observe this precaution could result in overheating or in damage to the camera.

Memory Cards

- Use only Secure Digital memory cards. See “Approved Memory Cards” (🔍:22) for recommended memory cards.
- Be sure to follow the precautions described in the documentation included with the memory card.
- Do not put labels or stickers on memory cards.
- The first time you insert a memory card that has been used in another device into this camera, be sure to format it with this camera. We recommend formatting new memory cards with this camera before using them with this camera.
- Note that **formatting a memory card permanently deletes all images and other data on the memory card**. Be sure to make copies of any images you wish to keep before formatting the memory card.
- If the message **Card is not formatted. Format card?** is displayed when the camera is turned on, the memory card must be formatted. If there is data that you do not want to delete, select **No**. Copy the necessary data to a computer, etc. If you want to format the card, select **Yes**. The confirmation dialog will be displayed. To start formatting, press the  button.
- Do not perform the following during formatting, while data is being written to or deleted from the memory card, or during data transfer to a computer. Failure to observe this precaution could result in the loss of data or in damage to the camera or memory card:
 - Open the battery-chamber/memory card slot cover to remove/insert the battery or memory card.
 - Turn off the camera.
 - Disconnect the AC adapter.
- Do not format the memory card using a computer.

Cleaning and Storage

Cleaning

Do not use alcohol, thinner, or other volatile chemicals.

Lens	Avoid touching glass parts with your fingers. Remove dust or lint with a blower (typically a small device with a rubber bulb attached to one end that is pumped to produce a stream of air out the other end). To remove fingerprints or other stains that cannot be removed with a blower, wipe the lens with a soft cloth, using a spiral motion that starts at the center of them and working toward the edges. If this fails, clean the lens using a cloth lightly dampened with commercial lens cleaner.
Monitor	Remove dust or lint with a blower. To remove fingerprints and other stains, clean the monitor with a soft, dry cloth, being careful not to apply pressure.
Body	Use a blower to remove dust, dirt, or sand, then wipe gently with a soft, dry cloth. After using the camera at the beach or other sandy or dusty environment, wipe off any sand, dust, or salt with a dry cloth lightly dampened with fresh water and dry thoroughly. Note that foreign matter inside the camera could cause damage not covered by the warranty.

Storage

Turn the camera off when not in use. Be sure that the power-on lamp is off before putting the camera away. Remove the battery if the camera will not be used for an extended period. Do not store the camera with naphtha or camphor moth balls, or in any of the following locations:

- Next to equipment that produces strong electromagnetic fields, such as televisions or radios
- Exposed to temperatures below -10°C (14°F) or above 50°C (122°F)
- Places that are poorly ventilated or subject to humidity of over 60%



To prevent mold or mildew, take the camera out of storage at least once a month. Turn the camera on and release the shutter a few times before putting the camera away again.











For storing the battery, follow the precautions in “The Battery” (🔋:3) in “Caring for the Product” (🔧:2).





Troubleshooting

If the camera fails to function as expected, check the list of common problems below before consulting your retailer or Nikon-authorized service representative.









Power, Display, Settings Issues







Problem	Cause/Solution	
The camera is on but does not respond.	<p>Wait for recording to end. If the problem persists, turn the camera off. If the camera does not turn off, remove and reinsert the battery or batteries or, if you are using an AC adapter, disconnect and reconnect the AC adapter. Note that although any data currently being recorded will be lost, data that have already been recorded will not be affected by removing or disconnecting the power source.</p>	 20, 85
Battery inserted in the camera cannot be charged.	<ul style="list-style-type: none">• Confirm all connections.• When connected to a computer, the camera may not charge for any of the reasons described below.<ul style="list-style-type: none">- Off is selected for Charge by computer in the setup menu.- Battery charging stops if the camera is turned off.- Battery charging is not possible if the camera's display language and date and time have not been set, or the date and time were reset after the camera's clock battery was exhausted. Use the Charging AC Adapter to charge the battery.- Battery charging may stop if the computer is in sleep mode.- Depending upon the computer specifications, settings, and status, battery charging may not be possible.	12 78,  85 – 16, 18 – –











Problem	Cause/Solution	
The camera cannot be turned on.	The battery is exhausted.	20
The camera turns off without warning.	<ul style="list-style-type: none"> • The camera automatically turns off to save power (auto off function). • The camera and battery may not work properly at low temperatures.  3 • The inside of the camera has become hot. Leave the camera off until the inside of the camera has cooled, and then try turning it on again. • The camera turns off if the USB cable connecting it to a computer or printer is disconnected.  25 	21 – 83, 86, 83, 86,  25
Monitor is blank.	<ul style="list-style-type: none"> • The camera is off. • The camera has entered standby mode to save power. Press the power switch, shutter-release button,  button,  button, or  (movie-record) button. • The flash lamp flashes while the flash is charging. Wait for the flash to charge. • The camera and computer are connected via the USB cable. • The camera and TV are connected via an HDMI cable. 	20 1, 21 47 83, 86 83,  22
Monitor is hard to read.	<ul style="list-style-type: none"> • Adjust the monitor brightness. • The monitor is dirty. Clean the monitor. 	77,  76  6





Problem	Cause/Solution	
Date and time of recording are not correct.	<ul style="list-style-type: none"> If the camera clock has not been set, the "Date not set" indicator flashes during shooting and movie recording. Images and movies saved before the clock is set are dated "00/00/0000 00:00" and "01/01/2014 00:00" respectively. Set the correct time and date for Time zone and date in the setup menu. The camera clock is not as accurate as ordinary watches or clocks. Periodically compare the time of the camera clock with that of a more accurate timepiece, and reset as required. 	16, 77,  74
No indicators displayed in monitor.	Hide info is selected for Photo info in Monitor settings in the setup menu.	77,  76
Print date not available.	Time zone and date has not been set in the setup menu.	16, 77,  74
Date not imprinted on images even when Print date is enabled.	<ul style="list-style-type: none"> The current shooting mode does not support Print date. The date cannot be imprinted on movies. 	77,  78
Screen for setting time zone and date is displayed when the camera is turned on.	The clock battery is exhausted; all settings were restored to their default values.	16, 18
The camera settings reset.		
The camera becomes hot.	The camera may become hot when used for an extended period of time to shoot movies or send images using an Eye-Fi card, or when used in a hot environment; this is not a malfunction.	-
The camera makes sound.	When Autofocus mode is set to Full-time AF or while in some shooting modes, the camera may produce an audible focusing sound.	56, 74

Shooting Issues



Problem	Cause/Solution	
Cannot switch to shooting mode.	Disconnect the HDMI cable or USB cable.	83, 86,  22,  25
No image captured when the shutter-release button is pressed.	<ul style="list-style-type: none">• When the camera is in playback mode, press the  button, shutter-release button, or  (▶  movie-record) button.• When menus are displayed, press the MENU button.• The battery is exhausted.• When the flash lamp is flashing, the flash is charging.	1, 28 4 20 47
The camera cannot focus.	<ul style="list-style-type: none">• The subject is too close. Try shooting using scene auto selector mode, Close-up scene mode, or macro mode.• The subject is hard to focus on.• Set AF assist in the setup menu to Auto.• Turn the camera off and then on again.	32, 36, 51 64 78,  81 20
Images are blurred.	<ul style="list-style-type: none">• Use the flash.• Increase the ISO sensitivity value.• Enable Photo VR and/or Motion detection when shooting still images. Enable Movie VR when recording movies.• Use BSS (Best Shot Selector).• Use a tripod to stabilize the camera when shooting (using the self-timer at the same time is more effective).	47 56 74, 77 37, 56,  39 49





Problem	Cause/Solution	
Bright specks appear in images captured with flash.	The flash is reflecting off particles in the air. Set the flash mode setting to  (off).	48
Flash does not fire.	<ul style="list-style-type: none"> • The flash mode is set to  (off). • A scene mode that restricts the flash is selected. • On is selected for Blink proof in the smart portrait menu. • On (continuous) or On (BSS) is selected for Smile timer in the smart portrait menu. • A function that restricts the flash is enabled. 	47 53 57 57 58
Digital zoom cannot be used.	<ul style="list-style-type: none"> • Digital zoom is set to Off in the setup menu. • Digital zoom cannot be used in the following situations: <ul style="list-style-type: none"> - When Portrait, Night portrait, Night landscape, Backlighting (when HDR is set to ON), Easy panorama, or Pet portrait is selected in scene mode - When smart portrait mode is selected - When Continuous in the shooting menu is set to Multi-shot 16 - When AF area mode in the shooting menu is set to Subject tracking 	78,  81 34 42 56,  39 56,  44
Image mode not available.	A function that restricts Image mode is enabled.	58
No sound when the shutter is released.	Off is selected for Shutter sound in the Sound settings setup menu. No sound is produced with some shooting modes and settings, even when On is selected.	78,  82



Problem	Cause/Solution	
AF-assist illuminator does not light.	Off is selected for AF assist in the setup menu. AF-assist illuminator may not light depending on the position of the focus area or the current scene mode, even when Auto is selected.	78,  81
Images appear smeared.	The lens is dirty. Clean the lens.	 6
Colors are unnatural.	White balance or hue is not adjusted properly.	36, 56,  36
Randomly spaced bright pixels (“noise”) appear in image.	The subject is dark and the shutter speed is too slow, or ISO sensitivity is too high. Noise can be reduced by: <ul style="list-style-type: none"> Using the flash Specifying a lower ISO sensitivity setting 	47 56,  42
Images are too dark (underexposed).	<ul style="list-style-type: none"> The flash mode is set to  (off). The flash window is blocked. The subject is beyond the range of the flash. Adjust exposure compensation. Increase ISO sensitivity. The subject is backlit. Select Backlighting scene mode or set the flash mode setting to  (fill flash). 	47 24 47 52 56,  42 37, 47
Images are too bright (overexposed).	Adjust exposure compensation.	52
Unexpected results when flash set to  (auto with red-eye reduction).	When taking images with  (auto with red-eye reduction), scene auto selector mode, or fill flash with slow sync and red-eye reduction in Night portrait scene mode, the In-Camera Red Eye Fix may be applied to areas not affected by red-eye in rare cases. Use any scene mode other than Night portrait , and change the flash mode to any setting other than  (auto with red-eye reduction) and try taking an image again.	32, 35, 47

Problem	Cause/Solution	
Skin tones are not softened.	<ul style="list-style-type: none"> • In some shooting conditions, facial skin tones may not be softened. • For images containing four or more faces, try using the Skin softening effect in Glamour retouch in the playback menu. 	42 68,  18
Saving images takes time.	<p>It may take more time to save images in the following situations:</p> <ul style="list-style-type: none"> • When the noise reduction function is in operation, such as when shooting in a dark environment • When the flash mode is set to  (auto with red-eye reduction) • When shooting in Night landscape, Night portrait, or Backlighting (when HDR is set to ON) scene mode • When the skin softening function is applied while shooting • When using continuous shooting mode 	– 48 35, 36, 37 57 56,  39
A ring-shaped belt or rainbow-colored stripe appears in the monitor or images.	When shooting with backlighting or when a very strong light source (such as sunlight) is in the frame, a ring-shaped belt or rainbow-colored stripe (ghosting) may occur. Change the position of the light source, or frame the image so that the light source does not enter the frame, and try again.	–

Playback Issues

Problem	Cause/Solution	
File cannot be played back.	<ul style="list-style-type: none">• This camera may not be able to play back images saved with another make or model of digital camera.• This camera cannot play back movies recorded with another make or model of digital camera.• This camera may not be able to play back data edited on a computer.	–
Cannot zoom in on image.	<ul style="list-style-type: none">• Playback zoom cannot be used with movies.• This camera may not be able to zoom in on images captured with another make or model of digital camera.	–
Cannot record voice memos.	<ul style="list-style-type: none">• Voice memos cannot be attached to movies.• Voice memos cannot be attached to images captured with other cameras. Voice memos attached to images using another camera cannot be played back on this camera.	– 68,  60
Cannot edit images.	<ul style="list-style-type: none">• Some images cannot be edited. Images that have already been edited may not be edited again.• There is not enough free space in the internal memory or on the memory card.• This camera is unable to edit images captured with other cameras.• Editing functions used for images are not available for movies.	38,  14 – – –

Problem	Cause/Solution	
Cannot rotate image.	This camera cannot rotate images captured with another make or model of digital camera.	–
Images are not displayed on TV.	<ul style="list-style-type: none"> • TV settings is not correctly set in the setup menu. • Both HDMI and USB cables are connected simultaneously. • The memory card contains no images. Replace the memory card. Remove the memory card to play back images from the internal memory. 	78,  84 83, 86,  22,  25 15
Nikon Transfer 2 does not start when the camera is connected to a computer.	<ul style="list-style-type: none"> • The camera is off. • The battery is exhausted. • The USB cable is not correctly connected. • The camera is not recognized by the computer. • The computer is not set to start Nikon Transfer 2 automatically. For more information about Nikon Transfer 2, refer to help information contained in ViewNX 2. 	20 20 83, 86 – 89
The PictBridge startup screen is not displayed when the camera is connected to a printer.	With some PictBridge-compatible printers, the PictBridge startup screen may not be displayed and it may be impossible to print images when Auto is selected for Charge by computer in the setup menu. Set Charge by computer to Off and reconnect the camera to the printer.	78,  85

Problem	Cause/Solution	
Images to be printed are not displayed.	<ul style="list-style-type: none"> • The memory card contains no images. Replace the memory card. • Remove the memory card to print images from the internal memory. 	14 15
Cannot select paper size with the camera.	<p>The camera cannot be used to select the paper size in the following situations, even when printing from a PictBridge-compatible printer. Use the printer to select the paper size.</p> <ul style="list-style-type: none"> • The printer does not support the paper sizes specified by the camera. • The printer automatically selects the paper size. 	83,  28,  29 –

Specifications

Nikon COOLPIX S5300 Digital Camera

Type	Compact digital camera
Number of effective pixels	16.0 million
Image sensor	$\frac{1}{2.3}$ -in. type CMOS; approx. 16.76 million total pixels
Lens	NIKKOR lens with 8 \times optical zoom
Focal length	4.5-36.0 mm (angle of view equivalent to that of 25-200 mm lens in 35mm [135] format)
f/-number	f/3.7-6.6
Construction	8 elements in 7 groups
Digital zoom magnification	Up to 4 \times (angle of view equivalent to that of approx. 800 mm lens in 35mm [135] format)
Vibration reduction	Lens shift (still pictures) Lens shift and electronic VR (movies)
Motion blur reduction	Motion detection (still pictures)
Autofocus (AF)	Contrast-detect AF
Focus range	<ul style="list-style-type: none">• [W]: Approx. 50 cm (1 ft 8 in.)–∞, [T]: Approx. 1.5 m (5 ft)–∞• Macro mode: Approx. 2 cm (0.8 in.)–∞ (wide-angle position) (All distances measured from center of front surface of lens)
Focus-area selection	Face priority, manual with 99 focus areas, center, subject tracking, target finding AF
Monitor	7.5 cm (3-in.), approx. 460k-dot, TFT LCD with anti-reflection coating and 5-level brightness adjustment
Frame coverage (shooting mode)	Approx. 97% horizontal and 97% vertical (compared to actual picture)
Frame coverage (playback mode)	Approx. 99% horizontal and 99% vertical (compared to actual picture)

Storage	
Media	Internal memory (approx. 25 MB), SD/SDHC/SDXC memory card
File system	DCF, Exif 2.3, and DPOF compliant
File formats	Still pictures: JPEG Sound files (Voice Memo): WAV Movies: MOV (Video: H.264/MPEG-4 AVC, Audio: LPCM stereo)
Image size (pixels)	<ul style="list-style-type: none"> • 16M (High) [4608 × 3456★] • 16M [4608 × 3456] • 8M [3264 × 2448] • 4M [2272 × 1704] • 2M [1600 × 1200] • VGA [640 × 480] • 16:9 [4608 × 2592] • 1:1 [3456 × 3456]
ISO sensitivity (Standard output sensitivity)	<ul style="list-style-type: none"> • ISO 125-1600 • ISO 3200, 6400 (available when using Auto mode)
Exposure	
Metering mode	Matrix, center-weighted (digital zoom less than 2×), spot (digital zoom 2× or more)
Exposure control	Programmed auto exposure and exposure compensation (–2.0 – +2.0 EV in steps of $\frac{1}{3}$ EV)
Shutter	
Speed	<ul style="list-style-type: none"> • $\frac{1}{1500}$-1 s • $\frac{1}{4000}$ s (maximum speed during high-speed continuous shooting) • 4 s (Fireworks show scene mode)
Aperture	
Range	2 steps (f/3.7 and f/10.5 [W])
Self-timer	Can be selected from 10 s and 2 s

Flash	
Range (approx.) (ISO sensitivity: Auto)	[W]: 0.5–3.5 m (1 ft 8 in.–11 ft) [T]: 1.5–2.0 m (5 ft–6 ft 6 in.)
Flash control	TTL auto flash with monitor preflashes
Interface	Hi-Speed USB equivalent
Data transfer protocol	MTP, PTP
HDMI output	Can be selected from Auto, 480p, 720p, and 1080i
I/O terminal	Micro-USB connector, HDMI micro connector (Type D) (HDMI output)
Supported languages	Arabic, Bengali, Bulgarian, Chinese (Simplified and Traditional), Czech, Danish, Dutch, English, Finnish, French, German, Greek, Hindi, Hungarian, Indonesian, Italian, Japanese, Korean, Marathi, Norwegian, Persian, Polish, Portuguese (European and Brazilian), Romanian, Russian, Serbian, Spanish, Swedish, Tamil, Telugu, Thai, Turkish, Ukrainian, Vietnamese
Power sources	One Rechargeable Li-ion Battery EN-EL19 (included) AC Adapter EH-62G (available separately)
Charging time	Approx. 1 h 50 min (when using Charging AC Adapter EH-71P and when no charge remains)
Battery life¹	
Still pictures	Approx. 180 shots when using EN-EL19
Movies (actual battery life for recording) ²	Approx. 35 min (1080/30p) when using EN-EL19 Approx. 40 min (1080/25p) when using EN-EL19
Tripod socket	1/4 (ISO 1222)
Dimensions (W × H × D)	Approx. 96.9 × 58.0 × 20.9 mm (3.9 × 2.3 × 0.9 in.) (excluding projections)
Weight	Approx. 138 g (4.9 oz) (including battery and SD memory card)

Operating environment

Temperature	0°C–40°C (32°F–104°F)
Humidity	85% or less (no condensation)

Wi-Fi (Wireless LAN)

Standards	IEEE 802.11b/g/n (standard wireless LAN protocol)
Communications protocols	IEEE 802.11b: DBPSK/DQPSK/CCK IEEE 802.11g: OFDM IEEE 802.11n: OFDM
Range (line of sight)	Approx. 10 m (11 yd)
Operating frequency	2412–2462 MHz (1–11 channels)
Data rates (actual measured values)	IEEE 802.11b: 5 Mbps IEEE 802.11g: 20 Mbps IEEE 802.11n: 20 Mbps
Security	WPA2
Access protocols	Infrastructure

- Unless otherwise stated, all figures assume a fully-charged battery and an ambient temperature of $23 \pm 3^{\circ}\text{C}$ ($73.4 \pm 5.4^{\circ}\text{F}$) as specified by the Camera and Imaging Products Association (CIPA).

- ¹ Battery life may vary depending on conditions of use, such as the interval between shots or the length of time that menus and images are displayed.
- ² Individual movie files cannot exceed 4 GB in size or 29 minutes in length. Recording may end before this limit is reached if camera temperature becomes elevated.

Rechargeable Li-ion Battery EN-EL19

Type	Rechargeable lithium-ion battery
Rated capacity	DC 3.7 V, 700 mAh
Operating temperature	0°C–40°C (32°F–104°F)
Dimensions (W × H × D)	Approx. 31.5 × 39.5 × 6 mm (1.3 × 1.6 × 0.3 in.)
Weight	Approx. 14.5 g (0.5 oz)

Charging AC Adapter EH-71P

Rated input	AC 100-240 V, 50/60 Hz, MAX 0.2 A
Rated output	DC 5.0 V, 1.0 A
Operating temperature	0°C–40°C (32°F–104°F)
Dimensions (W × H × D)	Approx. 55 × 22 × 54 mm (2.2 × 0.9 × 2.2 in.) (excluding plug adapter) For Argentina: Approx. 55 × 63 × 59 mm (2.2 × 2.5 × 2.4 in.) For Brazil: Approx. 55 × 67 × 59 mm (2.2 × 2.7 × 2.4 in.)
Weight	Approx. 48 g (1.7 oz) (excluding plug adapter) For Argentina: Approx. 73 g (2.6 oz) For Brazil: Approx. 70 g (2.5 oz)

Specifications

- Nikon will not be held liable for any errors this manual may contain.
- The appearance of this product and its specifications are subject to change without notice.

Approved Memory Cards

The following Secure Digital (SD) memory cards have been tested and approved for use in this camera.

- Memory cards with an SD Speed Class rating of 6 or faster are recommended for recording movies. When using a memory card with a lower Speed Class rating, movie recording may stop unexpectedly.

	SD memory card	SDHC memory card ²	SDXC memory card ³
SanDisk	2 GB ¹	4 GB, 8 GB, 16 GB, 32 GB	64 GB, 128 GB
TOSHIBA	–	4 GB, 8 GB, 16 GB, 32 GB	64 GB
Panasonic	2 GB ¹	4 GB, 8 GB, 16 GB, 32 GB	64 GB
Lexar	–	4 GB, 8 GB, 16 GB, 32 GB	64 GB, 128 GB

¹ If the memory card will be used with a card reader or similar device, make sure that the device supports 2 GB cards.

² SDHC compliant.

If the memory card will be used with a card reader or similar device, make sure that the device supports SDHC.



³ SDXC compliant.

If the memory card will be used with a card reader or similar device, make sure that the device supports SDXC.



- Contact the manufacturer for details on the above cards. We cannot guarantee camera performance when using memory cards made by other manufacturers.

AVC Patent Portfolio License

This product is licensed under the AVC Patent Portfolio License for the personal and non-commercial use of a consumer to (i) encode video in compliance with the AVC standard ("AVC video") and/or (ii) decode AVC video that was encoded by a consumer engaged in a personal and non-commercial activity and/or was obtained from a video provider licensed to provide AVC video. No license is granted or shall be implied for any other use. Additional information may be obtained from MPEG LA, L.L.C.

See **<http://www.mpegla.com>**.

Trademark Information

- Microsoft, Windows and Windows Vista are either registered trademarks or trademarks of Microsoft Corporation in the United States and/or other countries.
- Mac, OS X, the iFrame logo and the iFrame symbol are trademarks or registered trademarks of Apple Inc., in the U.S. and other countries.
- Adobe and Acrobat are registered trademarks of Adobe Systems Inc.
- SDXC, SDHC, and SD Logos are trademarks of SD-3C, LLC.
- PictBridge is a trademark.
- HDMI, HDMI logo and High-Definition Multimedia Interface are trademarks or registered trademarks of HDMI Licensing LLC.

HDMI

- Wi-Fi and the Wi-Fi logo are trademarks or registered trademarks of the Wi-Fi Alliance.
- Android and Google Play are trademarks or registered trademarks of Google, Inc.
- All other trade names mentioned in this manual or the other documentation provided with your Nikon product are the trademarks or registered trademarks of their respective holders.

FreeType License (FreeType2)



























- Portions of this software are copyright © 2012 The FreeType Project (<http://www.freetype.org>). All rights reserved.

















MIT License (HarfBuzz)













































- Portions of this software are copyright © 2014 The HarfBuzz Project (<http://www.freedesktop.org/wiki/Software/HarfBuzz>). All rights reserved.

Index

Symbols

 Scene auto selector mode	32
 Scene mode	34
SO Special effects mode	40
 Smart portrait mode	42
 Auto mode	44
 Playback mode	28
 Favorite pictures mode	 66
 Auto sort mode	 10
 List by date mode	 11
 Wi-Fi options menu	81,  71
 Setup menu	77,  73
T (Telephoto)	25
W (Wide-angle)	25
 Playback zoom	66
 Thumbnail playback	67
 Help	34
 Shooting mode button	2, 22
 Playback button	2, 28
 (movie-record) button	2, 70
 Apply selection button	2
MENU Menu button	2, 4, 55, 68, 74, 77, 81
 Delete button	2, 30,  61
 Flash mode	47
 Self-timer	49

 Macro mode	51
 Exposure compensation	52
A	
AC adapter	83,  95
Adding favorites pictures	69,  66
AF area mode	56,  44
AF assist	1, 78,  81
Album	 9
Aperture value	27
Auto flash	48
Auto mode	22, 44
Auto off	21, 78,  82
Auto sort mode	 10
Auto with red-eye reduction	48
Autofocus	56, 72,  48,  68
Autofocus mode	56, 74,  48,  68
B	
Backlighting 	34, 37
Battery	10, 12, 18
Battery chamber	 95
Battery charger	13,  95
Battery latch	10
Battery level indicator	20
Battery-chamber/memory card slot cover	2, 10, 14

Beach 	34	Copying images.....	69,  61
Best Shot Selector.....	37,  40	Crop.....	 21
Black and white copy 	34, 37	Cross process 	41
Black-and-white.....	 43	Current settings.....	 71
Blink proof.....	57,  51	Cyanotype.....	 43
Blink warning.....	78,  86	D	
Brightness.....	77,  76	Date and time.....	16, 77,  74
BSS.....	37,  40	Date format.....	17,  74
Built-in microphone (stereo).....	1	Daylight.....	 36
Button sound.....	 82	Daylight saving time.....	17, 18,  74
C		Delete.....	30, 76,  13,  61
Calendar Display.....	67	Digital zoom.....	25, 78,  81
Capturing still images while recording movies.....	73	Direct print.....	 24
Charge by computer.....	78,  85	D-Lighting.....	68,  16
Charge lamp.....	2, 13	DPOF printing.....	 31
Charging AC Adapter.....	12,  21	DSCN.....	 94
Choose key picture	69,  12,  63	Dusk/dawn 	34
Close-up 	34, 36	E	
Cloudy.....	 36	Easy panorama 	34, 38,  2
Color options.....	56,  43	Easy panorama playback.....	38,  5
Compression ratio.....	 34	Editing images.....	 14
Computer.....	84, 86	EH-71P.....	 21
Connecting to smart devices	81,  71	EN-EL19.....	 21
Connector cover.....	1	Exposure compensation.....	52
Continuous.....	56,  39	Extension.....	 94
		Eye-Fi upload.....	78,  87
		Eyelet for camera strap.....	1

E

Face detection	61
Face priority	44
Favorite pictures mode	66
File names	94
Fill flash	48
Fireworks show 	34, 37
Firmware version	78, 88
Fixed range auto	42
Flash	1, 47
Flash lamp	2, 47
Flash mode	47, 48
Flash off	48
Fluorescent	36
Focus	26, 56, 44
Focus area	26, 61
Focus indicator	7, 26
Focus lock	65
Food 	34, 36
Format internal memory	78, 83
Format memory cards	15, 78, 83
Formatting	15, 78, 83
Frame rate	74, 70
FSCN	94
Full-frame playback	66
Full-time AF	56, 74, 48, 68
Functions that cannot be used simultaneously	58

G

Glamour retouch	68, 18
-----------------------	---------

H

HDMI	84
HDMI cable	84, 22
HDMI device control	84
HDMI micro connector	1, 83
HDR	37
Help	34
High key 	40
High-contrast monochrome 	40
High-speed continuous	39
HS movie	74, 65, 66

I

Identifier	94
Image mode	56, 34
Image review	77, 76
Image size	56, 34
Imprinting date and time	18, 78
Incandescent	36
Internal memory	15, 20
Internal memory indicator	7, 9
ISO sensitivity	56, 42

J

JPG	94
-----------	----

L

Landscape 	34
Language	78, 84

Lens.....	1,	17
Lens cover.....		1
List by date mode.....		11
Low key		40
M		
Macro mode.....		51
Memory card.....	14,	22
Memory card slot.....		14
Micro-USB connector.....	1,	83
Mirror		41
Monitor.....	2, 6,	6
Monitor settings.....	77,	76
Motion detection.....	77,	80
MOV.....		94
Movie editing.....	76,	32
Movie length.....	70, 71	
Movie menu.....	74,	64
Movie options.....	74,	64
Movie playback.....		75
Movie recording.....		70
Movie VR.....	74,	69
Multi selector.....	2, 4	
Multi-shot 16.....		40
Museum		34, 37
N		
Night landscape		34, 36
Night portrait		34, 35
Nikon Transfer 2.....		87

Nostalgic sepia SE		40
Number of exposures remaining.....		20,
		35

O

Open with HS footage.....		74,
		66,
		68
Optical zoom.....		25
Optional accessories.....		95
Options.....		71

P

Painting		40
Paper size.....		28,
		29
Party/indoor		34, 35
Pet portrait auto release.....		39
Pet portrait		34, 39
Photo info.....	77,	76
Photo VR.....	77,	79
PictBridge.....	84,	24
Playback.....	28, 66, 75,	60
Playback menu.....	68,	52
Playback mode.....		28
Playback zoom.....		66
Pop POP		40
Portrait		34
Power.....		20
Power connector cover.....		1
Power switch.....	1, 20	
Power-on lamp.....	1, 20	

Preset manual	37
Pre-shooting cache.....	39, 41
Pressing halfway	27
Print	68, 84, 27, 29, 52
Print date	18, 77, 53, 55, 78
Print order	68, 52
Printer.....	84, 24
Protect.....	68, 57

Q

Quick effects.....	29, 45, 14, 48
Quick retouch.....	68, 16

R

Rechargeable Li-ion battery	21
Recording slow motion movies	74, 65, 66
Red-eye correction.....	68, 17
Removing favorite pictures	69, 8
Reset all	78, 88
Restore default settings	71
Rotate image	68, 59
RSCN.....	94

S

Scene mode	34
Selective color 	40
Self-timer.....	49
Self-timer lamp	1, 50
Sepia.....	43

Sequence display options	69, 12, 63
Setup menu.....	77, 73
Shooting	22, 24, 26
Shooting menu	56, 34
Shooting mode.....	22
Shutter sound.....	82
Shutter speed.....	27
Shutter-release button	1, 26
Single	56, 39
Single AF.....	56, 74, 48, 68
Skin softening.....	57, 62, 49
Slide show	68, 56
Slow sync	48
Small picture	68, 20
Smart portrait menu.....	55, 49
Smart portrait mode.....	42
Smile timer	57, 50
Snow 	34
Soft SO	40
Sound settings.....	78, 82
Speaker	2
Special effects mode.....	40
Sports 	34, 35
SSCN.....	94
Standard color.....	56, 43
Strap.....	3
Subject tracking	45, 47

Sunset ..... 34

Super vivid **VI**..... 40

I

Target finding AF..... 56, 63, 46

Telephoto 25

Televisions 84, 22

Thumbnail display 67

Time difference 74

Time zone 18, 74

Time zone and date..... 16, 77, 74

Toy camera effect 1 1..... 40

Toy camera effect 2 2..... 41

Tripod socket 2, 19

TV settings 78, 84

U

USB cable 84, 86, 25

V

ViewNX 2 85

Vivid color 43

Voice memo 68, 60

Volume 75, 60

W

WAV 94

Welcome screen 77, 73

White balance 56, 36

Wide-angle..... 25

Wi-Fi disconnection..... 81, 71

Wi-Fi options menu 81, 71

Wind noise reduction 74, 70

Wireless LAN..... 79

Wireless Mobile Utility..... 79

Z

Zoom control..... 1, 25

Zooming in/out 25

No reproduction in any form of this manual, in whole or in part (except for brief quotation in critical articles or reviews), may be made without written authorization from NIKON CORPORATION.

NIKON CORPORATION

© 2014 Nikon Corporation



YP3L01(11)
6MN37611-01