

Nikon

DIGITAL CAMERA

COOLPIX S6600

Reference Manual



En



Highlight Feature of the COOLPIX S6600

Gesture control - Easily Take Self-portraits



The direction and angle of the monitor on this camera can be adjusted.

You can easily take self-portrait images in combination with **Gesture control**.

- When you open the monitor and face it forward in the same direction as the camera lens, you can take images without pressing the shutter-release button, simply by moving your hand toward an icon displayed on the monitor.







Move your hand toward .



Countdown starts.



An image is taken.

- The shooting functions listed below are available.
 - : Start recording a movie
 - : Take a still image
 - : Zoom out (wide-angle)
 - : Zoom in (telephoto)

For detailed operating instructions, see page  46.

Introduction	
Parts of the Camera	
The Basics of Shooting and Playback	
Shooting Features	
Playback Features	
Recording and Playing Back Movies	
General Camera Setup	
Using the Wi-Fi (Wireless LAN) Function	
Connecting the Camera to a TV, Computer, or Printer	
Reference Section	
Technical Notes and Index	

Introduction

Read This First

Thank you for purchasing the Nikon COOLPIX S6600 digital camera. Before using the camera, please read the information in "For Your Safety" (📖viii-x) and familiarize yourself with the information provided in this manual. After reading, please keep this manual handy and refer to it to enhance your enjoyment of your new camera.

About This Manual





If you want to start using the camera right away, see “The Basics of Shooting and Playback” (📖10).

To learn about the parts of the camera and information that is displayed in the monitor, see “Parts of the Camera” (📖1).

Other Information

- Symbols and Conventions

To make it easier to find the information you need, the following symbols and conventions are used in this manual:

Symbol	Description
	This icon indicates cautions and information that should be read before using the camera.
	This icon indicates notes and information that should be read before using the camera.
	These icons indicate other pages containing relevant information;  : "Reference Section",  : "Technical Notes and Index."

- SD and SDHC/SDXC memory cards are referred to as "memory cards" in this manual.
- The setting at the time of purchase is referred to as the "default setting."
- The names of menu items displayed in the camera monitor, and the names of buttons or messages displayed on a computer monitor appear in bold.
- In this manual, images are sometimes omitted from monitor display samples so that monitor indicators can be more clearly shown.
- Illustrations and monitor content shown in this manual may differ from the actual product.

Information and Precautions

Life-Long Learning

As part of Nikon's "Life-Long Learning" commitment to ongoing product support and education, continually updated information is available online at the following sites:

- For users in the U.S.A.: <http://www.nikonusa.com/>
- For users in Europe and Africa: <http://www.europe-nikon.com/support/>
- For users in Asia, Oceania, and the Middle East: <http://www.nikon-asia.com/>

Visit these sites to keep up-to-date with the latest product information, tips, answers to frequently asked questions (FAQs), and general advice on digital imaging and photography. Additional information may be available from the Nikon representative in your area. Visit the site below for contact information:

<http://imaging.nikon.com/>

Use Only Nikon Brand Electronic Accessories

Nikon COOLPIX cameras are designed to the highest standards and include complex electronic circuitry. Only Nikon brand electronic accessories (including battery chargers, batteries, Charging AC adapters, and AC adapters) certified by Nikon specifically for use with this Nikon digital camera are engineered and proven to operate within the operational and safety requirements of this electronic circuitry.

THE USE OF NON-NIKON ELECTRONIC ACCESSORIES COULD DAMAGE THE CAMERA AND MAY VOID YOUR NIKON WARRANTY.

The use of third-party rechargeable Li-ion batteries not bearing the Nikon holographic seal could interfere with normal operation of the camera or result in the batteries overheating, igniting, rupturing, or leaking.

For more information about Nikon brand accessories, contact a local authorized Nikon dealer.

Holographic seal: Identifies this device as an authentic Nikon product.



Before Taking Important Pictures

Before taking pictures on important occasions (such as at weddings or before taking the camera on a trip), take a test shot to ensure that the camera is functioning normally. Nikon will not be held liable for damages or lost profits that may result from product malfunction.

About the Manuals

- No part of the manuals included with this product may be reproduced, transmitted, transcribed, stored in a retrieval system, or translated into any language in any form, by any means, without Nikon's prior written permission.
- Nikon reserves the right to change the specifications of the hardware and software described in these manuals at any time and without prior notice.
- Nikon will not be held liable for any damages resulting from the use of this product.
- While every effort was made to ensure that the information in these manuals is accurate and complete, we would appreciate it were you to bring any errors or omissions to the attention of the Nikon representative in your area (address provided separately).

Notice Concerning Prohibition of Copying or Reproduction

Note that simply being in possession of material that was digitally copied or reproduced by means of a scanner, digital camera or other device may be punishable by law.

• Items prohibited by law from being copied or reproduced

Do not copy or reproduce paper money, coins, securities, government bonds or local government bonds, even if such copies or reproductions are stamped "Sample." The copying or reproduction of paper money, coins, or securities which are circulated in a foreign country is prohibited. Unless the prior permission of the government was obtained, the copying or reproduction of unused postage stamps or post cards issued by the government is prohibited.

The copying or reproduction of stamps issued by the government and of certified documents stipulated by law is prohibited.

• Cautions on certain copies and reproductions

The government has issued cautions on copies or reproductions of securities issued by private companies (shares, bills, checks, gift certificates, etc.), commuter passes, or coupon tickets, except when a minimum of necessary copies are to be provided for business use by a company. Also, do not copy or reproduce passports issued by the government, licenses issued by public agencies and private groups, ID cards and tickets, such as passes and meal coupons.

• Comply with copyright notices

The copying or reproduction of copyrighted creative works such as books, music, paintings, woodcut prints, maps, drawings, movies, and photographs is governed by national and international copyright laws. Do not use this product for the purpose of making illegal copies or to infringe copyright laws.

Disposing of Data Storage Devices

Please note that deleting images or formatting data storage devices such as memory cards or built-in camera memory does not completely erase the original image data. Deleted files can sometimes be recovered from discarded storage devices using commercially available software, potentially resulting in the malicious use of personal image data. Ensuring the privacy of such data is the user's responsibility.

Before discarding a data storage device or transferring ownership to another person, erase all data using commercial deletion software, or format the device and then completely refill it with images containing no private information (for example, pictures of empty sky). Be sure to also replace any pictures selected for the **Select an image** option in the **Welcome screen** setting (📖78). Care should be taken to avoid injury or damage to property when physically destroying data storage devices.

For Your Safety

To prevent damage to your Nikon product or injury to yourself or to others, read the following safety precautions in their entirety before using this equipment. Keep these safety instructions where all those who use the product will read them.

The consequences that could result from failure to observe the precautions listed in this section are indicated by the following symbol:



This icon marks warnings, information that should be read before using this Nikon product, to prevent possible injury.

WARNINGS

Turn off in the event of malfunction

Should you notice smoke or an unusual smell coming from the camera or Charging AC Adapter, unplug the Charging AC Adapter and remove the battery immediately, taking care to avoid burns. Continued operation could result in injury. After removing or disconnecting the power source, take the equipment to a Nikon-authorized service representative for inspection.

Do not disassemble

Touching the internal parts of the camera or Charging AC Adapter could result in injury. Repairs should be performed only by qualified technicians. Should the camera or Charging AC Adapter break open as the result of a fall or other accident, take the product to a Nikon-authorized service

representative for inspection, after unplugging the product and/or removing the battery.

Do not use the camera or Charging AC Adapter in the presence of flammable gas

Do not use electronic equipment in the presence of flammable gas, as this could result in explosion or fire.

 **Handle the camera strap with care**
Never place the strap around the neck of an infant or child.

 **Keep out of reach of children**
Particular care should be taken to prevent infants from putting the battery or other small parts into their mouths.

 **Do not remain in contact with the camera, battery charger, or AC adapter for extended periods while the devices are on or in use**

Parts of the devices become hot. Leaving the devices in direct contact with the skin for extended periods may result in low-temperature burns.

 **Do not leave the product where it will be exposed to extremely high temperatures, such as in an enclosed automobile or in direct sunlight**

Failure to observe this precaution could cause damage or fire.

 **Observe caution when handling the battery**

The battery may leak, overheat, or explode if improperly handled. Observe the following precautions when handling the battery for use in this product:

- Before replacing the battery, turn the product off. If you are using the Charging AC Adapter/AC adapter, be sure it is unplugged.
- Use only a Rechargeable Li-ion Battery EN-EL19 (included). Charge the battery by using a camera that supports battery charging or by using a Battery Charger MH-66 (available separately). To charge the battery with the camera, use either Charging AC Adapter EH-70P (included) or the **Charge by computer** function.

- When inserting the battery, do not attempt to insert it upside down or backwards.
- Do not short or disassemble the battery or attempt to remove or break the battery insulation or casing.
- Do not expose the battery to flame or to excessive heat.
- Do not immerse in or expose to water.
- Put the battery in the battery case before transporting it. Do not transport or store with metal objects such as necklaces or hairpins.
- The battery is prone to leakage when fully discharged. To avoid damage to the product, be sure to remove the battery when no charge remains.
- Discontinue use immediately should you notice any change in the battery, such as discoloration or deformation.
- If liquid from the damaged battery comes in contact with clothing or skin, rinse immediately with plenty of water.

 **Observe the following precautions when handling the Charging AC Adapter**

- Keep dry. Failure to observe this precaution could result in fire or electric shock.
- Dust on or near the metal parts of the plug should be removed with a dry cloth. Continued use could result in fire.
- Do not handle the plug or go near the Charging AC Adapter during lightning storms. Failure to observe this precaution could result in electric shock.

- Do not damage, modify, forcibly tug or bend the USB cable, place it under heavy objects, or expose it to heat or flames. Should the insulation be damaged and the wires become exposed, take it to a Nikon-authorized service representative for inspection. Failure to observe these precautions could result in fire or electric shock.
- Do not handle the plug or Charging AC Adapter with wet hands. Failure to observe this precaution could result in electric shock.
- Do not use with travel converters or adapters designed to convert from one voltage to another or with DC-to-AC inverters. Failure to observe this precaution could damage the product or cause overheating or fire.

Use appropriate cables

When connecting cables to the input and output jacks, use only the cables provided or sold by Nikon for the purpose, to maintain compliance with product regulations.

Handle moving parts with care

Be careful that your fingers or other objects are not pinched by the lens cover or other moving parts.

CD-ROMs

The CD-ROMs included with this device should not be played back on audio CD equipment. Playing CD-ROMs on an audio CD player could cause hearing loss or damage the equipment.

Using the flash close to your subject's eyes could cause temporary visual impairment.

The flash should be no less than 1 meter (3 ft 4 in.) from the subject.

Particular care should be observed when photographing infants.

Do not operate the flash with the flash window touching a person or object

Failure to observe this precaution could result in burns or fire.

Avoid contact with liquid crystal

Should the monitor break, care should be taken to avoid injury caused by broken glass and to prevent liquid crystal from the monitor touching the skin or entering the eyes or mouth.

Turn the power off when using inside an airplane or the hospital

Turn the power off while inside the airplane during take off or landing. Do not use wireless network functions while in the air. Follow the instructions of the hospital when using while in a hospital. The electromagnetic waves emitted by this camera may disrupt the electronic systems of the airplane or the instruments of the hospital. If you are using an Eye-Fi card, remove it from the camera before boarding an aircraft or entering a hospital.

Notices

Notices for Customers in the U.S.A.

IMPORTANT SAFETY INSTRUCTIONS -

SAVE THESE INSTRUCTIONS.

DANGER - TO REDUCE THE RISK OF FIRE OR ELECTRIC SHOCK, CAREFULLY FOLLOW THESE INSTRUCTIONS

For connection to a supply not in the U.S.A., use an attachment plug adapter of the proper configuration for the power outlet if needed.

The power supply unit is intended to be correctly orientated in a vertical or floor mount position.

Federal Communications Commission (FCC) Radio Frequency Interference Statement

This equipment has been tested and found to comply with the limits for a Class B digital device, pursuant to Part 15 of the FCC rules. These limits are designed to provide reasonable protection against harmful interference in a residential installation. This equipment generates, uses, and can radiate radio frequency energy and, if not installed and used in accordance with the

instructions, may cause harmful interference to radio communications. However, there is no guarantee that interference will not occur in a particular installation. If this equipment does cause harmful interference to radio or television reception, which can be determined by turning the equipment off and on, the user is encouraged to try to correct the interference by one or more of the following measures:

- Reorient or relocate the receiving antenna.
- Increase the separation between the equipment and receiver.
- Connect the equipment into an outlet on a circuit different from that to which the receiver is connected.
- Consult the dealer or an experienced radio/television technician for help.



Nikon

COOLPIX S6600

CAUTIONS

Modifications

The FCC requires the user to be notified that any changes or modifications made to this device that are not expressly approved by Nikon Corporation may void the user's authority to operate the equipment.

Interface Cables

Use the interface cables sold or provided by Nikon for your equipment. Using other interface cables may exceed the limits of Class B Part 15 of the FCC rules.

Notice for customers in the State of California

WARNING

Handling the cord on this product will expose you to lead, a chemical known to the State of California to cause birth defects or other reproductive harm.

Wash hands after handling.

Nikon Inc.,
1300 Walt Whitman Road
Melville, New York 11747-3064
USA
Tel: 631-547-4200

Notice for customers in Canada

CAN ICES-3 B / NMB-3 B

Notices for customers in Europe

CAUTIONS

RISK OF EXPLOSION IF BATTERY IS REPLACED BY AN INCORRECT TYPE.

DISPOSE OF USED BATTERIES ACCORDING TO THE INSTRUCTIONS.

This symbol indicates that electrical and electronic equipment is to be collected separately.



The following apply only to users in European countries:

- This product is designated for separate collection at an appropriate collection point. Do not dispose of as household waste.
- Separate collection and recycling helps conserve natural resources and prevent negative consequences for human health and the environment that might result from incorrect disposal.
- For more information, contact the retailer or the local authorities in charge of waste management.

This symbol on the battery indicates that the battery is to be collected separately.



The following apply only to users in European countries:

- All batteries, whether marked with this symbol or not, are designated for separate collection at an appropriate collection point. Do not dispose of as household waste.
- For more information, contact the retailer or the local authorities in charge of waste management.

Wi-Fi (Wireless LAN Network)

This product is controlled by the United States Export Administration Regulations, and you are required to obtain permission from the United States government if you export or re-export this product to any country to which the United States embargoes goods. The following countries were subject to embargo: Cuba, Iran, North Korea, Sudan, and Syria. Since the target countries are subject to change, please contact the United States Department of Commerce for the latest information.

Restrictions on Wireless Devices

The wireless transceiver included in this product conforms to wireless regulations in the country of sale and is not for use in other countries (products purchased in the EU or EFTA can be used anywhere within the EU and EFTA). Nikon does not accept liability for use in other countries. Users who are unsure as to the original country of sale should consult with their local Nikon service center or Nikon-authorized service representative. This restriction applies to wireless operation only and not to any other use of the product.

Notice for Customers in the U.S.A. and Canada

Federal Communications Commission (FCC) and Industry of Canada (IC)

Declaration of Conformity

This device complies with Part 15 of FCC Rules and Industry Canada licence-exempt RSS standard(s). Operation is subject to the following two conditions: (1) this device may not cause interference, and (2) this device must accept any interference, including interference that may cause undesired operation of this device.

FCC/IC RF Exposure Statement

This transmitter must not be co-located or operated in conjunction with any other antenna or transmitter.

The available scientific evidence does not show that any health problems are associated with using low power wireless devices. There is no proof, however, that these low power wireless devices are absolutely safe. Low power wireless devices emit low levels of radio frequency energy (RF) in the microwave range while being used. Whereas high levels of RF can produce health effects (by heating tissue), exposure of low-level RF that does not produce heating effects causes no known adverse health effects. Many studies of low-level RF exposures have not found any biological effects. Some studies have suggested that some biological effects might occur, but such findings have not been confirmed by additional research.

COOLPIX S6600 (FCC ID:CGJ1150EB/IC ID:4634A-1150EB) has been tested and found to comply with FCC/IC radiation exposure limits set forth for an uncontrolled environment and meets the FCC radio frequency (RF) Exposure Guidelines in Supplement C to OET65 and RSS-102 of the IC radio frequency (RF) Exposure rules. Please refer to the SAR test report that was uploaded to FCC website.

Declaration of Conformity (Europe)

Hereby, Nikon Corporation, declares that COOLPIX S6600 is in compliance with the essential requirements and other relevant provisions of Directive 1999/5/EC. The declaration of conformity may be consulted at http://imaging.nikon.com/support/pdf/DoC_S6600.pdf.

Notice for Customers in Singapore

This device complies with radio-frequency regulations.

**Complies with
IDA Standards
DA103423**



Precautions when Using Radio Transmissions











- Always keep in mind that radio transmission or reception of data is subject to interception by third parties. Note that Nikon is not responsible for data or information leaks that may occur during data transfer.
- The operating frequency band of this equipment is used by industrial, scientific, consumer and medical equipment including microwave ovens, premises radio stations for identifying mobile units used in the manufacturing lines of plants (radio stations requiring no license), and amateur radio stations (hereinafter referred to as "another station").
 1. Before using this equipment, confirm that another station is not being operated nearby.
 2. In the event of this equipment causing harmful radio wave interference with another station, promptly change the operating frequency or stop radio wave emission by turning off the power, etc.
 3. If you have further questions, contact a Nikon service center or Nikon authorized service representative.

Personal Information Management and Disclaimer

- User information registered and configured on the product, including wireless LAN connection settings and other personal information, is susceptible to alteration and loss resulting from operational error, static electricity, accident, malfunction, repair or other handling. Always keep separate copies of important information. Nikon is not responsible for any direct or indirect damages or lost profits resulting from alteration or loss of content that is not attributable to Nikon.
- Before discarding this product or transferring it to another owner, perform **Reset all** in the setup menu (☐79) to delete all user information registered and configured with the product, including wireless LAN connection settings and other personal information.

Table of Contents

Introduction	ii	Step 1 Turn the Camera On.....	20
Read This First	ii	Step 2 Select a Shooting Mode.....	22
About This Manual.....	iii	Available Shooting Modes.....	23
Information and Precautions.....	v	Step 3 Frame a Picture	24
For Your Safety	viii	Using the Zoom	25
WARNINGS	viii	Step 4 Focus and Shoot.....	26
Notices	xi	The Shutter-release Button	27
Wi-Fi (Wireless LAN Network).....	xiii	Step 5 Play Back Images	28
.....		Step 6 Delete Images.....	30
Parts of the Camera	1	Shooting Features	32
The Camera Body.....	1	 (Scene Auto Selector) Mode.....	32
Attaching the Camera Strap.....	3	Scene Mode (Shooting Suited to Scenes)	
Opening and Adjusting the Angle of the		34
Monitor.....	3	Tips and Notes.....	35
Using Menus (the MENU Button).....	4	Special Effects Mode (Applying Effects	
The Monitor	6	When Shooting)	40
Shooting Mode	6	Smart Portrait Mode (Capturing Images of	
Playback Mode	8	Smiling Faces)	42
.....		 (Auto) Mode	44
The Basics of Shooting and Playback		Using Quick Effects.....	45
.....	10	Using the Self-timer with Gesture Control	
Preparation 1 Insert the Battery	10	46
Preparation 2 Charge the Battery	12	Functions That Can Be Set Using the Multi	
Preparation 3 Insert a Memory Card.....	14	Selector.....	48
Internal Memory and Memory Cards.....	15	Using the Flash	49
Preparation 4 Setting the Display Language,		Using the Self-timer	51
Date, and Time.....	16	Using Macro Mode.....	53

Adjusting Brightness (Exposure Compensation).....	54
Default Settings.....	55
Functions That Can Be Set with the MENU Button (Shooting Menu)	57
Options Available in the Shooting Menu	58
Functions That Cannot Be Used Simultaneously.....	60
Focusing.....	63
Using Target Finding AF	63
Using Face Detection	64
Using Skin Softening.....	65
Subjects Not Suitable for Autofocus	66
Focus Lock.....	67
Playback Features.....	68
Playback Zoom	68
Thumbnail Playback, Calendar Display.....	69
Functions That Can Be Set with the MENU Button (Playback Menu)	70
Recording and Playing Back Movies....	72
Recording Movies	72
Functions That Can Be Set with the MENU Button (Movie Menu)	75
Playing Back Movies	76
General Camera Setup.....	78
Functions That Can Be Set with the MENU Button (Setup Menu)	78
Using the Wi-Fi (Wireless LAN) Function	80
Functions That Can Be Performed Using Wi-Fi	80
Take Photos.....	80
View Photos	80
Installing the Software on the Smart Device	80
Connecting the Smart Device to the Camera	81
Connecting the Camera to a TV, Computer, or Printer.....	83
Connection Methods.....	83
Using ViewNX 2	85
Installing ViewNX 2.....	85
Transferring Images to the Computer.....	88
Viewing Images	90
Reference Section	1 
Using Easy Panorama (Shooting and Playback)	2 
Shooting with Easy Panorama	2 
Viewing Images Captured with Easy Panorama	5 
Favorite Pictures Mode.....	6 
Adding Images to Albums.....	6 
Playing Back Images in Albums.....	7 
Removing Images from Albums	8 
Changing the Favorites Album Icon	9 
Auto Sort Mode	10 

List by Date Mode.....	011	White Balance (Adjusting Hue).....	036
Viewing and Deleting Images Captured		Continuous Shooting	039
Continuously (Sequence).....	012	ISO Sensitivity.....	042
Viewing Images in a Sequence	012	Color Options.....	043
Deleting Images in a Sequence	013	AF Area Mode.....	044
Editing Still Images.....	014	Autofocus Mode	048
Before Editing Images	014	Quick Effects	048
Quick Effects: Changing Hue or Mood		The Smart Portrait Menu.....	049
.....	015	Skin Softening.....	049
Quick Retouch: Enhancing Contrast and		Smile Timer.....	050
Saturation.....	016	Blink Proof.....	051
D-Lighting: Enhancing Brightness and		The Playback Menu	052
Contrast.....	016	Print Order (Creating a DPOF Print Order)	
Red-eye Correction: Correcting Red-eye		052
When Shooting with the Flash.....	017	Slide Show	056
Glamour Retouch: Enhancing Human Faces		Protect	057
.....	018	Rotate Image.....	059
Small Picture: Reducing the Size of an		Voice Memo.....	060
Image.....	020	Copy (Copy Between Internal Memory and	
Crop: Creating a Cropped Copy	021	Memory Card).....	061
Connecting the Camera to a TV (Viewing		Sequence Display Options	063
Images on a TV)	022	Choose Key Picture	063
Connecting the Camera to a Printer (Direct		The Movie Menu	064
Print)	024	Movie Options.....	064
Connecting the Camera to a Printer		Open with HS Footage	068
.....	025	Autofocus Mode	068
Printing Individual Images.....	027	Wind Noise Reduction	069
Printing Multiple Images	029	The Setup Menu	070
Editing Movies	032	Welcome Screen.....	070
The Shooting Menu (for  (Auto) Mode)		Time Zone and Date.....	071
.....	034	Monitor Settings	073
Image Mode Settings (Image Size and		Print Date (Imprinting Date and Time)	
Quality)	034	075

Gesture Control.....	76	Index.....	25
Vibration Reduction.....	77		
Motion Detection.....	78		
AF Assist.....	79		
Digital Zoom.....	79		
Sound Settings.....	80		
Auto Off.....	80		
Format Memory/Format Card.....	81		
Language.....	82		
TV Settings.....	82		
Charge by Computer.....	83		
Blink Warning.....	84		
Wi-Fi Options.....	85		
Eye-Fi Upload.....	87		
Reset All.....	88		
Firmware Version.....	88		
Error Messages.....	89		
File Names.....	94		
Optional Accessories.....	95		
<hr/>			
Technical Notes and Index.....	1		
Caring for the Product.....	2		
The Camera.....	2		
The Battery.....	3		
Charging AC Adapter.....	4		
Memory Cards.....	5		
Cleaning and Storage.....	6		
Cleaning.....	6		
Storage.....	6		
Troubleshooting.....	7		
Specifications.....	17		
Approved Memory Cards.....	22		



A series of ten horizontal dashed lines spanning the width of the page, intended for handwriting practice.

Parts of the Camera

The Camera Body

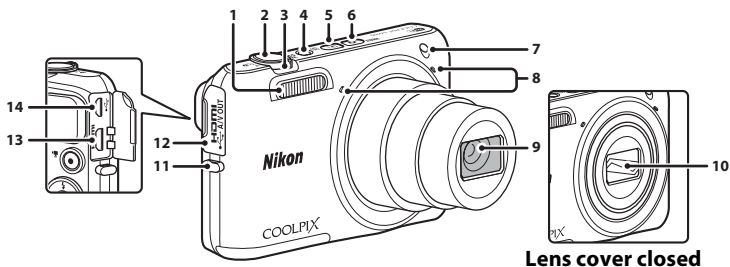

1	Flash.....	49
2	Shutter-release button.....	26
	Zoom control.....	25
	W : wide-angle.....	25
	T : telephoto.....	25
3	: thumbnail playback.....	69
	: playback zoom.....	68
	: help.....	34
4	Power switch/power-on lamp.....	20
5	(playback) button.....	28
6	(shooting mode) button.....	22

7	Self-timer lamp.....	51
	AF-assist illuminator.....	79
8	Microphone (stereo)	
9	Lens	
10	Lens cover	
11	Eyelet for camera strap.....	3
12	Connector cover.....	83
13	HDMI micro connector (Type D).....	83
14	USB/audio/video output connector.....	83

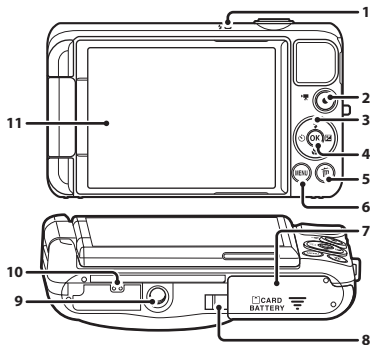

1	Charge lamp.....	13
	Flash lamp.....	49
2	● (●/ movie-record) button.....	72
3	Multi selector.....	4
4	OK (apply selection) button.....	4
5	🗑️ (delete) button.....	30, 61
6	MENU (menu) button.....	4, 57, 70, 75, 78

7	Battery-chamber/ memory card slot cover.....	10, 14
8	Power connector cover (for connection with optional AC adapter)	
9	Tripod socket	
10	Speaker	
11	Monitor.....	3, 6

Attaching the Camera Strap

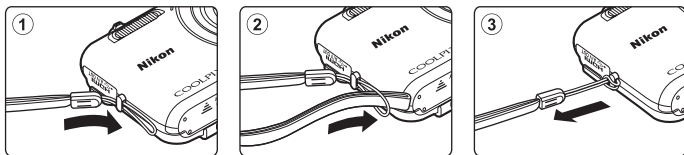

Opening and Adjusting the Angle of the Monitor

The direction and angle of the monitor on this camera can be adjusted. This is useful when shooting with the camera in a high or low position. In addition, using this feature with **Gesture control** (📖46) makes it easy to take self-portrait images.

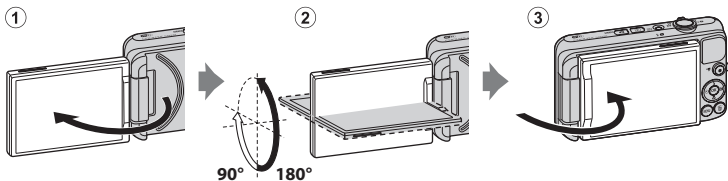

For normal shooting, fold the monitor against the back of the camera, facing rearward (③).

To protect the monitor from scratches and dirt while you are carrying or not using the camera, close the monitor so that it is facing inward against the back of the camera.



✓ Notes About the Monitor

When moving the monitor, do not apply excessive force and make sure to turn it slowly within the adjustable range.

Using Menus (the MENU Button)

Use the multi selector and **OK** button to navigate the menus.

1 Press the MENU button.

- The menu is displayed.

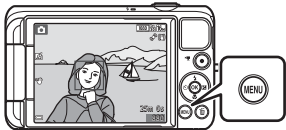

2 Press the multi selector ◀.

- The current menu icon is displayed in yellow.

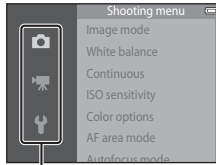

Menu icons

3 Select the desired menu icon.

- The menu is changed.

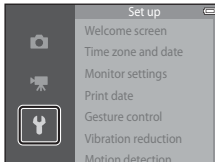

4 Press the OK button.

- The menu options become selectable.

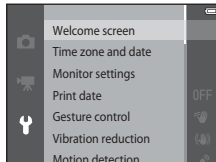

5 Select a menu option.

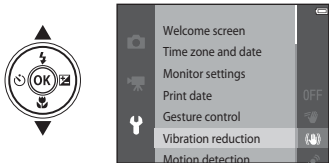

6 Press the **OK** button.

- The settings for the option you selected are displayed.

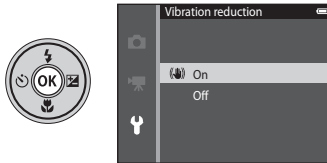

7 Select a setting.

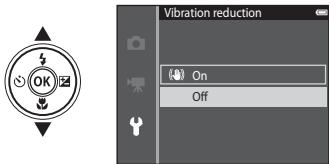



8 Press the **OK** button.

- The setting you selected is applied.
- When you are finished using the menu, press the **MENU** button.



Notes About Setting Menu Options

- Certain menu options cannot be set depending on the current shooting mode or the state of the camera. Unavailable options are displayed in gray and cannot be selected.
- When a menu is displayed, you can switch to shooting mode by pressing the shutter-release button,  (shooting mode) button, or  (movie-record) button.





The Monitor

The information that is displayed in the monitor during shooting and playback changes depending on the camera's settings and state of use.

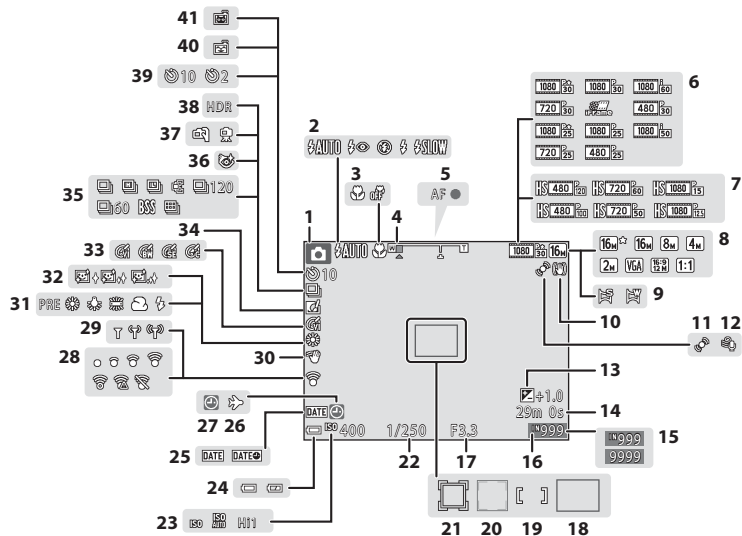
By default, information is displayed when the camera is first turned on and when you operate the camera, and turns off after a few seconds (when **Photo info** is set to **Auto info** in **Monitor settings** (☐78)).

Shooting Mode



1	Shooting mode.....	22, 23	21	Focus area (subject tracking).....	58,  47
2	Flash mode.....	49	22	Shutter speed.....	27
3	Macro mode.....	53	23	ISO sensitivity.....	58
4	Zoom indicator.....	25, 53	24	Battery level indicator.....	20
5	Focus indicator.....	26	25	Print date.....	78
6	Movie options (normal speed movies)	75,  64	26	Travel destination icon.....	 71
7	Movie options (HS movies).....	75,  65	27	“Date not set” indicator.....	16
8	Image mode.....	58,  34	28	Eye-Fi communication indicator.....	79
9	Easy panorama.....	38	29	Wi-Fi communication indicator.....	79
10	Vibration reduction icon.....	78	30	Gesture control.....	46, 78
11	Motion detection icon.....	79	31	White balance mode.....	58
12	Wind noise reduction.....	75	32	Skin softening.....	59
13	Exposure compensation value.....	54	33	Color options.....	58
14	Movie recording time remaining.....	72	34	Quick effects icon.....	45, 58
15	Number of exposures remaining (still images).....	20	35	Continuous shooting mode.....	58
16	Internal memory indicator.....	20	36	Blink proof icon.....	59
17	Aperture value.....	27	37	Hand-held/tripod.....	35, 36
18	Focus area (target finding AF).....	26, 58, 63	38	Backlighting (HDR).....	37
19	Focus area (for manual or center)....	58, 67	39	Self-timer indicator.....	51
20	Focus area (face detection, pet detection).....	39, 42, 58, 64	40	Smile timer.....	59
			41	Pet portrait auto release.....	39

Playback Mode

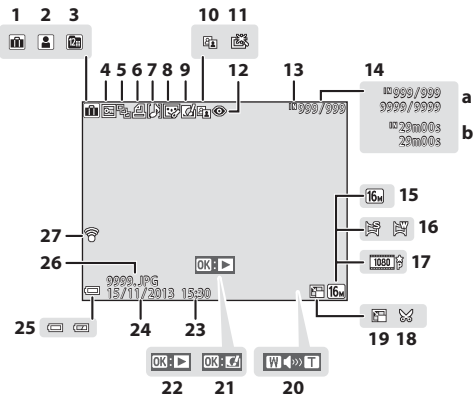

1	Album icon in favorite pictures mode	6
2	Category icon in auto sort mode.....	10
3	List by date icon.....	11
4	Protect icon.....70,	57
5	Sequence display (when Individual pictures is selected).....71,	63
6	Print order icon.....70,	52
7	Voice memo indicator.....70,	60
8	Glamour retouch icon.....70,	18
9	Quick effects icon.....29, 45,	15
10	D-Lighting icon.....70,	16
11	Quick retouch icon.....70,	16
12	Red-eye correction.....70,	17
13	Internal memory indicator.....	20
14	(a) Current image number/ total number of images (b) Movie length	
15	Image mode.....	58, 34
16	Easy panorama.....	38
17	Movie options.....	75, 64
18	Crop icon.....	68, 21
19	Small picture icon.....	70, 20
20	Volume indicator.....	76, 60
21	Quick effects guide.....	29
22	Easy panorama playback guide...38,	5
	Sequence playback guide.....	71, 12
	Movie playback guide.....	76
23	Time of recording	
24	Date of recording	
25	Battery level indicator.....	20
26	File number and type.....	94
27	Eye-Fi communication indicator	79, 87

The Basics of Shooting and Playback

Preparation 1 Insert the Battery

- 1 Open the battery-chamber/memory card slot cover.

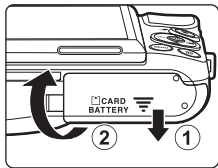

- 2 Insert the battery.

- Push the orange battery latch in the direction indicated by the arrow (①), and fully insert the battery (②).
- The battery locks into place when inserted correctly.

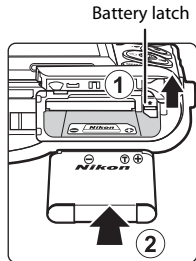

- ✓ Be Careful to Insert the Battery in Correct Direction**

Inserting the battery upside down or backwards could damage the camera.



- 3** Close the battery-chamber/memory card slot cover.

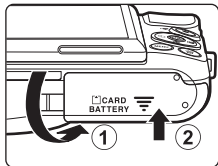

Removing the Battery

Turn the camera off and make sure that the power-on lamp and the monitor have turned off, and then open the battery-chamber/memory card slot cover.

Move the battery latch in the direction indicated by the arrow (1) to eject the battery (2).

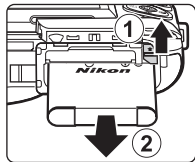

High Temperature Caution

The camera, battery, and memory card may be hot immediately after using the camera.

Preparation 2 Charge the Battery

1 Prepare the included Charging AC Adapter.

If a plug adapter* is included with your camera, attach the plug adapter to the plug on the Charging AC Adapter. Push the plug adapter firmly until it is securely held in place. Once the two are connected, attempting to forcibly remove the plug adapter could damage the product.

* The shape of the plug adapter varies according to the country or region in which the camera was purchased. The Charging AC Adapter comes with the plug adapter attached in Argentina and Korea.

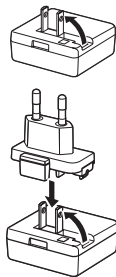

2 Make sure the battery is installed in the camera, and then connect the camera to the Charging AC Adapter in order of ① to ③.

- Keep the camera turned off.
- Make sure that the plugs are properly oriented. Do not insert or remove the plugs at an angle when connecting or disconnecting them.

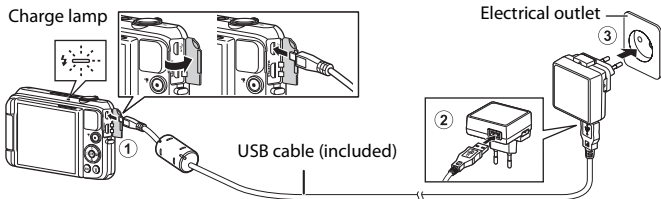



- The charge lamp slowly flashes green to indicate that the battery is charging.
- Shooting is not possible while the camera is connected to the Charging AC Adapter.

Charge lamp	Description
Flashes slowly (green)	The battery is charging.
Off	When charging is complete, the charge lamp stops flashing green and turns off. About 3 hours are required to charge a fully exhausted battery.
Flashes quickly (green)	<ul style="list-style-type: none"> The ambient temperature is not suited to charging. Charge the battery indoors with an ambient temperature of 5°C to 35°C (41°F to 95°F). The USB cable or Charging AC Adapter is not properly connected, or there is a problem with the battery. Disconnect the USB cable or unplug the Charging AC Adapter and correctly connect it again, or change the battery.

3 Disconnect the Charging AC Adapter from the electrical outlet and then disconnect the USB cable.

Charging Using a Computer or Battery Charger

- You can also charge the battery by connecting the camera to a computer (83, 83).
- You can use the Battery Charger MH-66 (available separately; 95) to charge the battery without using the camera.

Preparation 3 Insert a Memory Card

- 1 Turn off the camera and open the battery-chamber/memory card slot cover.

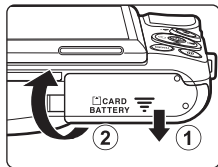

- 2 Insert the memory card.

- Slide the memory card in until it clicks into place.

Memory card slot

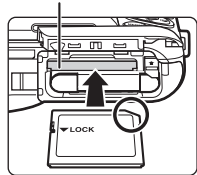

- Be Careful to Insert the Memory Card in Correct Direction**

Inserting the memory card upside down or backwards could damage the camera and the memory card.



- 3 Close the battery-chamber/memory card slot cover.

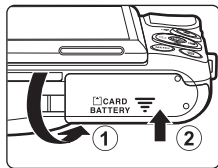

✔ Formatting Memory Cards

The first time you insert a memory card that has been used in another device into this camera, make sure to format it with this camera. Insert the card into the camera, press the **MENU** button, and select **Format card** in the setup menu.

Removing Memory Cards

Turn the camera off and make sure that the power-on lamp and the monitor have turned off, and then open the battery-chamber/memory card slot cover.

Gently push the memory card into the camera (①) to partially eject the card (②).

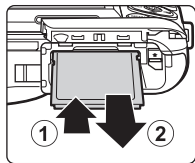

✔ High Temperature Caution

The camera, battery, and memory card may be hot immediately after using the camera.

Internal Memory and Memory Cards

Camera data, including images and movies, can be saved either in the camera's internal memory or on a memory card. To use the camera's internal memory, first remove the memory card.



Preparation 4 Setting the Display Language, Date, and Time

When the camera is turned on for the first time, the language-selection screen and the date and time setting screen for the camera clock are displayed.

- If you exit without setting the date and time,  will flash when the shooting screen is displayed.

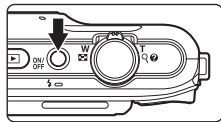
- 1 Press the power switch to turn on the camera.



- 2 Use the multi selector   to select the desired language and press the  button.

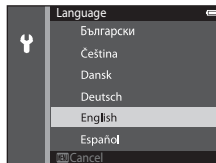

- 3 Select **Yes** and press the  button.

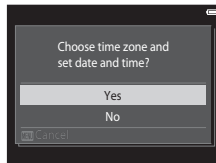

4 Select your home time zone and press the **OK** button.

- To enable daylight saving time, press ▲.
- When the daylight saving time function is enabled, ☀ is displayed above the map.
- To turn off the daylight saving time function, press ▼.

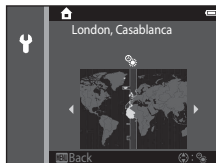

5 Select the date format and press the **OK** button.

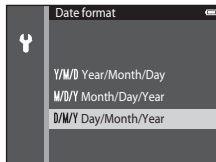

6 Set the date and time, and press the **OK** button.

- Select a field: Press ◀▶ (changes between **D**, **M**, **Y**, hour, and minute).
- Edit the date and time: Press ▲▼.
- Confirm the setting: Select the minute field and press the **OK** button.

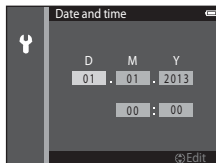

7 Select **Yes** and press the **OK** button.

- When settings are finished, the lens extends and the camera switches to shooting mode.

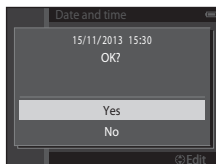

Changing the Language Setting and the Date and Time Setting

- You can change these settings using the **Language** and **Time zone and date** settings in the **Y** setup menu (📖78).
- You can enable or disable daylight saving time in the **Y** setup menu by selecting **Time zone and date** followed by **Time zone**. Press the multi selector **▶** and then **▲** to enable daylight saving time and move the clock forward one hour, or **▼** to disable daylight saving time and move the clock back one hour.

The Clock Battery

- The camera's clock is powered by a built-in backup battery.
The backup battery charges when the main battery is inserted into the camera or when the camera is connected to an optional AC adapter, and it can run the clock for several days after about ten hours of charging.
- If the camera's backup battery becomes exhausted, the date and time setting screen is displayed when the camera is turned on. Set the date and time again. See step 3 (📖16) of "Preparation 4 Setting the Display Language, Date, and Time" for more information.

Imprinting the Shooting Date on Printed Images

- You can permanently imprint the shooting date on images as they are captured by setting **Print date** in the setup menu (📖78).
- If you want the shooting date to be printed without using the **Print date** setting, print using the ViewNX 2 software (📖85).



A series of ten horizontal dashed lines spanning the width of the page, intended for handwriting practice.

Step 1 Turn the Camera On

1 Press the power switch.

- The monitor turns on.
- To turn the camera off, press the power switch again.

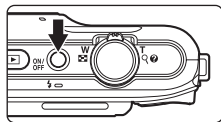

2 Check the battery level indicator and the number of exposures remaining.

Battery level indicator

Display	Description
	The battery level is high.
	The battery level is low.
 Battery exhausted.	The camera cannot capture images. Recharge the battery.

Number of exposures remaining



Battery level indicator



Number of Exposures Remaining

The number of images that can be taken is displayed.

-  is displayed when no memory card is inserted in the camera, and images are saved in the internal memory.

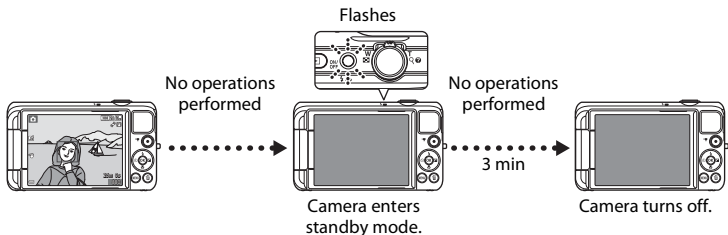
The Auto Off Function





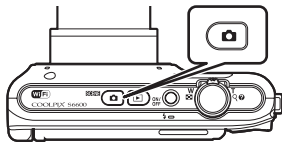

- The time that elapses before the camera enters standby mode is about one minute. The time can be changed using the **Auto off** setting in the setup menu (p.78).
- While the camera is in standby mode, the monitor turns back on if you perform any of the following operations or open the monitor:
 - Press the power switch, shutter-release button,  (shooting mode) button,  (playback) button, or  (movie-record) button

Step 2 Select a Shooting Mode

- 1 Press the  button.







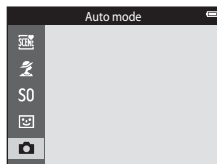



- 2 Use the multi selector   to select a shooting mode and press the  button.

-  (auto) mode is used in this example.
- The shooting mode setting is saved even after the camera is turned off.



Available Shooting Modes

	Scene auto selector  32
	The camera automatically selects the optimum scene mode when you frame an image, making it even easier to take images using settings that suit the scene.
	Scene mode  34
	Camera settings are optimized according to the scene that you select.
S0	Special effects  40
	Effects can be applied to images during shooting.
	Smart portrait  42
	When the camera detects a smiling face, you can take an image automatically without pressing the shutter-release button (smile timer). You can also use the skin softening option to smooth the skin tones of human faces.
	Auto mode  44
	Used for general shooting. Settings can be adjusted to suit the shooting conditions and the type of shot you want to capture.

Step 3 Frame a Picture

1 Hold the camera steady.

- Keep fingers and other objects away from the lens, flash, AF assist-illuminator, microphone, and speaker.
- When taking pictures in portrait (“tall”) orientation, turn the camera so that the flash is above the lens.

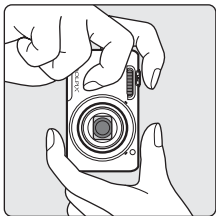
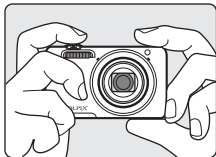

2 Frame the picture.



When Using a Tripod

- We recommend using a tripod to stabilize the camera in the following situations.
 - When shooting in dim lighting
 - When shooting with the flash mode (📖50) set to  (off)
 - When using the telephoto setting
- When using a tripod to stabilize the camera during shooting, set **Vibration reduction** to **Off** in the setup menu (📖78) to prevent potential errors caused by this function.

Using the Zoom

When you move the zoom control, the zoom lens position changes.



- To zoom in closer to the subject: Move toward **T** (telephoto)
- To zoom out and view a larger area: Move toward **W** (wide-angle)

When you turn the camera on, the zoom moves to the maximum wide-angle position.

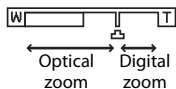
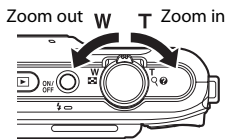
- A zoom indicator is displayed at the top of the monitor when the zoom control is moved.
- Digital zoom, which allows you to further magnify the subject up to approximately 4× the maximum optical zoom ratio, can be activated by moving and holding the zoom control toward **T** when the camera is zoomed in to the maximum optical zoom position.



Digital Zoom and Interpolation

While using digital zoom, the image quality decreases due to interpolation when the zoom is increased beyond the  position. The position of  moves to the right as the size of an image decreases.



Step 4 Focus and Shoot

1 Press the shutter-release button halfway.

- When the subject is in focus, the focus area glows green (multiple focus areas can glow green).
- When you are using digital zoom, the camera focuses on the subject in the center of the frame and the focus area is not displayed. When the camera has focused, the focus indicator (📖7) glows green.
- If the focus area or focus indicator flashes red, the camera is unable to focus. Modify the composition and try pressing the shutter-release button halfway again.

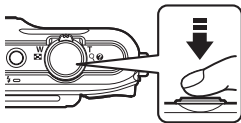

2 Without lifting your finger, press the shutter-release button the rest of the way down.



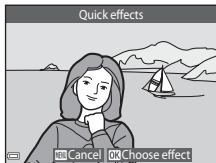

3 To apply an effect to the captured image, press the **OK** button.

- The screen for selecting an effect is displayed. See "Using Quick Effects" (📖45) for more information.
- When you press the **MENU** button or when no operations are performed for about five seconds, the monitor display returns to the shooting screen.
- To not display the screen shown on the right, set **Quick effects** to **Off** in the shooting menu (📖57).



The Shutter-release Button

<p>Press halfway</p> 	<p>To set focus and exposure (shutter speed and aperture value), press the shutter-release button lightly until you feel a slight resistance. Focus and exposure remain locked while the shutter-release button is pressed halfway.</p>
<p>Press all the way</p> 	<p>Press the shutter-release button all the way to release the shutter and take an image. Do not use force when pressing the shutter-release button, as this may result in camera shake and blurred images. Press the button gently.</p>

Notes About Saving Images and Recording Movies

The indicator showing the number of exposures remaining or the indicator showing the maximum movie length flashes while images are being saved or while a movie is being recorded. **Do not open the battery-chamber/memory card slot cover or remove the battery or memory card** while an indicator is flashing. Doing this could result in loss of data, or in damage to the camera or the memory card.



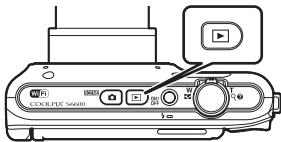

Step 5 Play Back Images

1 Press the (playback) button.

- If you press and hold down the  (playback) button while the camera is turned off, the camera turns on in playback mode.



2 Use the multi selector to select an image to display.

- Press and hold down  to scroll through the images quickly.
- To return to shooting mode, press the  button or shutter-release button.



Display the previous image



Display the next image



Notes About the Quick Effects Function



- When **OK**:  is displayed in full-frame playback mode, you can press **OK** button to apply an effect to the image.
- When the effect selection screen is displayed, use the multi selector  to select an effect, press the **OK** button, and then select **Yes** in the confirmation dialog and press the **OK** button to save the image as a separate file.
See "Quick Effects: Changing Hue or Mood" (15) for more information.



Step 6 Delete Images

- 1 Press the  button to delete the image currently displayed in the monitor.



- 2 Use the multi selector   to select the desired deletion method and press the  button.

- To exit without deleting, press the **MENU** button.

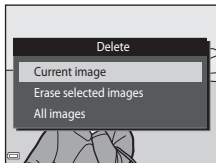

- 3 Select **Yes** and press the  button.

- Deleted images cannot be recovered.
- To cancel, select **No** and press the  button.

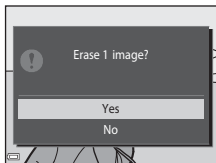

Operating the Erase Selected Images Screen

1 Use the multi selector ◀▶ to select an image to be deleted, and then use ▲ to display 🗑️.

- To undo the selection, press ▼ to remove 🗑️.
- Move the zoom control (📐1) toward T (📄) to switch to full-frame playback or W (🖼️) to switch to thumbnail playback.



2 Add 🗑️ to all images that you want to delete and then press the OK button to confirm the selection.

- A confirmation dialog is displayed. Follow the instructions displayed in the monitor.

✓ Deleting Images in a Sequence

- If you press the 🗑️ button and delete a key picture while only key pictures are displayed for sequences of images (📖71), all images in the sequence, including the key picture, are deleted.
- To delete individual images in a sequence, press the OK button to display them one at a time and press the 🗑️ button.



📎 Deleting the Last Image Captured While in Shooting Mode

When using shooting mode, press the 🗑️ button to delete the last image that was saved.











Shooting Features

(Scene Auto Selector) Mode

The camera automatically selects the optimum scene mode when you frame an image, making it even easier to take images using settings that suit the scene.

Enter shooting mode →  (shooting mode) button →  (scene auto selector) mode →  button



- When you point the camera at the subject, the camera automatically selects the optimum scene mode from the list below and adjusts the shooting settings accordingly.

	Portrait (for taking close-up portraits of one or two people)
	Portrait (for taking portraits of three or more people, or framing images with a large background size)
	Landscape
	Night portrait (for taking close-up portraits of one or two people)
	Night portrait (for taking portraits of three or more people, or framing images with a large background size)
	Night landscape
	Close-up
	Backlighting (for taking images of subjects other than people)
	Backlighting (for taking portrait images)
	Other scenes



- The focus area depends on the composition of the image. When the camera detects a human face, it focuses on that face (64).



Selecting Scene Modes









- When using digital zoom,  is selected as the shooting scene mode.
- In some shooting conditions, the camera may not select the appropriate scene mode that you intended. If this happens, switch to  (auto) mode or select the scene mode that you want to use when taking images (22).

Functions Available in (Scene Auto Selector) Mode

















- Flash mode (49)
- Self-timer (51)
- Exposure compensation (54)

Scene Mode (Shooting Suited to Scenes)

When a scene is selected, camera settings are automatically optimized for the selected scene.

Enter shooting mode →  (shooting mode) button →  (second icon from the top*)
→       → select a scene →  button

* The icon of the last scene selected is displayed.

 Portrait (default setting)	 Landscape ¹	 Sports ² (📖35)	 Night portrait (📖35)
 Party/indoor ² (📖35)	 Beach ²	 Snow ²	 Sunset ^{2, 3}
 Dusk/dawn ^{1, 3}	 Night landscape ¹ (📖36)	 Close-up (📖36)	 Food (📖36)
 Museum ² (📖37)	 Fireworks show ^{1, 3} (📖37)	 Black and white copy ² (📖37)	 Backlighting ² (📖37)
 Easy panorama (📖38)	 Pet portrait (📖39)		

¹ The camera focuses at infinity.

² The camera focuses on the area in the center of the frame.

³ Use of a tripod is recommended, because the shutter speed is slow. Set **Vibration reduction** to **Off** in the setup menu (📖78) when using a tripod to stabilize the camera during shooting.

To View a Description (Help Display) of Each Scene

Select a scene and move the zoom control (📖1) toward **T** (🔍) to view a description of that scene. To return to the original screen, move the zoom control toward **T** (🔍) again.





Tips and Notes

Sports

- While the shutter-release button is held all the way down, the camera shoots up to about 6 images continuously at a rate of about 2 fps (when image mode is set to **16M**).
- The frame rate for continuous shooting may vary depending upon the current image mode setting, the memory card used, or shooting condition.
- Focus, exposure, and hue are fixed at the values determined with the first image in each series.



Night portrait

- From the screen displayed after  **Night portrait** is selected, select **Hand-held** or **Tripod**.
- **Hand-held** (default setting):
 - When the  icon at the top left of the monitor glows green, press the shutter-release button all the way to capture a series of images which are combined into a single image and saved.
 - Once the shutter-release button is pressed all the way, hold the camera still until a still image is displayed. After taking an image, do not turn the camera off before the monitor switches to the shooting screen.
 - If the subject moves while the camera is shooting continuously, the image may be distorted, overlapped, or blurred.
- **Tripod**:
 - One image is captured at a slow shutter speed when the shutter-release button is pressed all the way.
 - Vibration reduction is disabled even when **Vibration reduction** () in the setup menu is set to **On**.





Party/indoor

- To avoid the effects of camera shake, hold the camera steady. Set **Vibration reduction** to **Off** in the setup menu () when using a tripod to stabilize the camera during shooting.





Night landscape

- From the screen displayed after  **Night landscape** is selected, select **Hand-held** or **Tripod**.
- **Hand-held** (default setting):
 - When the  icon at the top left of the monitor glows green, press the shutter-release button all the way to capture a series of images which are combined into a single image and saved.
 - Once the shutter-release button is pressed all the way, hold the camera still until a still image is displayed. After taking an image, do not turn the camera off before the monitor switches to the shooting screen.
 - The angle of view (i.e., the area visible in the frame) seen in the saved image is narrower than that seen in the monitor at the time of shooting.
- **Tripod**:
 - One image is captured at a slow shutter speed when the shutter-release button is pressed all the way.
 - Vibration reduction is disabled even when **Vibration reduction** (78) in the setup menu is set to **On**.

Close-up

- Macro mode (53) is enabled and the camera automatically zooms to the closest position at which it can focus.
- You can move the focus area. Press the  button, use the multi selector  to move the focus area, and press the  button to apply the setting.

Food

- Macro mode (53) is enabled and the camera automatically zooms to the closest position at which it can focus.
- You can adjust hue by using the multi selector . The hue setting is saved in the camera's memory even after the camera is turned off.
- You can move the focus area. Press the  button, use the multi selector  to move the focus area, and press the  button to apply the setting.

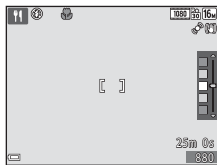

Museum

- The camera captures a series of up to ten images while the shutter-release button is held all the way down, and the sharpest image in the series is automatically selected and saved (BSS (Best Shot Selector)).
- The flash does not fire.



Fireworks show

- The shutter speed is fixed at about four seconds.
- The zoom is restricted to four fixed positions.



Black and white copy

- Use together with macro mode (53) when shooting subjects that are close to the camera.

Backlighting

- From the screen displayed after  **Backlighting** is selected, select **On** or **Off** to enable or disable the high dynamic range (HDR) function based on the type of image you want to take.
- **Off** (default setting): The flash fires to prevent the subject from being hidden in shadow.
 - When the shutter-release button is pressed all the way down, one image is captured.
- **On**: Use when taking images with very bright and dark areas in the same frame.
 - When the shutter-release button is pressed all the way, the camera shoots images continuously at high speed, and saves the following two images.
 - A non-HDR composite image
 - An HDR composite image in which the loss of details in highlights or shadows is minimized
 - If there is only enough memory to save one image, an image processed by D-Lighting (70) at the time of shooting, in which dark areas of the image are corrected, is the only image saved.
 - Once the shutter-release button is pressed all the way, hold the camera still until a still image is displayed. After taking an image, do not turn the camera off before the monitor switches to the shooting screen.
 - The angle of view (i.e., the area visible in the frame) seen in the saved image is narrower than that seen in the monitor at the time of shooting.

Easy panorama

- From the screen displayed after  **Easy panorama** is selected, select the shooting range from **Normal (180°)** or **Wide (360°)**.
 - The zoom position is fixed at wide-angle.
 - Press the shutter-release button all the way down, remove your finger from the button, and then slowly pan the camera horizontally. Shooting ends when the camera captures the specified shooting range.
 - Focus and exposure are locked when shooting starts.
 - If you press the  button when a captured image is displayed in full-frame playback mode, the image scrolls automatically.
 - The images cannot be edited on this camera.
- See "Using Easy Panorama (Shooting and Playback)" () for more information.



Notes About Printing Panorama Images

The entire image may not be able to be printed depending on the printer's settings. Additionally, printing may not be possible depending on the printer.

Pet portrait

- When you point the camera at a dog or cat, the camera detects the pet's face and focuses on it. By default, the shutter is automatically released when focus is acquired (pet portrait auto release).
- From the screen displayed after  **Pet portrait** is selected, select **Single** or **Continuous**.
 - **Single**: Whenever the detected face is in focus, the camera captures one image.
 - **Continuous**: Whenever the detected face is in focus, the camera captures three images continuously.

Pet Portrait Auto Release

- Press the multi selector  to change the **Pet portrait auto release** settings.
 - : The camera detects a dog or cat face and automatically releases the shutter when the detected face is in focus.
 - **OFF**: The camera does not release the shutter automatically, even if a dog or cat face is detected. Press the shutter-release button. The camera also detects human faces when **OFF** is selected.
- **Pet portrait auto release** is set to **OFF** after five bursts have been taken.
- Shooting is also possible by pressing the shutter-release button, regardless of the **Pet portrait auto release** setting. When **Continuous** is selected, you can take images continuously while holding down the shutter-release button all the way.





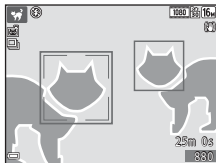

Focus Area

- When the camera detects a face, the face is displayed inside a yellow border. When the camera acquires focus on a face displayed inside a double border (focus area), the double border turns green. If no faces are detected, the camera focuses on the subject in the center of the frame.
- In some shooting conditions, the pet face may not be detected and other subjects may be displayed inside a border.











Special Effects Mode (Applying Effects When Shooting)

Effects can be applied to images during shooting.

Enter shooting mode →  (shooting mode) button → S0 (third icon from the top*) →  →    → select an effect → 

* The icon of the last effect selected is displayed.

Category	Description
S0 Soft* (default setting)	Softens the image by adding a slight blur to the entire image.
SE Nostalgic sepia*	Adds a sepia tone and reduces the contrast to simulate the qualities of an old photograph.
 High-contrast monochrome	Changes the image to black and white and gives it sharp contrast.
 High key	Gives the entire image a bright tone.
 Low key	Gives the entire image a dark tone.
 Selective color	Creates a black and white image in which only the specified color remains.
POP Pop	Increases the color saturation of the entire image to create a bright look.
VI Super vivid	Increases the color saturation of the entire image and sharpens the contrast.
 Painting	Gives the image a painting-like appearance.
 Toy camera effect 1	Gives the entire image a yellowish hue and darkens the image periphery.
 Toy camera effect 2	Decreases the color saturation of the entire image and darkens the image periphery.
 Cross process	Gives the image a mysterious appearance based on a specific color.
 Mirror*	Creates a bilaterally symmetric image whose right half is an inverted mirror image of the left half.

* Some effects are not available when using certain **Movie options** () settings.

- The camera focuses on the area in the center of the frame.
- When **Selective color** or **Cross process** is selected, use the multi selector ▲▼ to select the desired color from the slider.

To change settings for any of the following functions, press the **OK** button to cancel color selection.

- Flash mode (📖49)
- Self-timer (📖51)
- Macro mode (📖53)
- Exposure compensation (📖54)

To return to the color selection screen, press the **OK** button again.



Slider

Smart Portrait Mode (Capturing Images of Smiling Faces)

When the camera detects a smiling face, you can take an image automatically without pressing the shutter-release button (smile timer (📖59)). You can use the skin softening option to smooth the skin tones of human faces.

Enter shooting mode → 📷 (shooting mode) button → 😊 Smart portrait mode → ⓧ button

1 Frame the picture.

- Point the camera at a human face.

2 Without pressing the shutter-release button, wait for the subject to smile.

- If the camera detects that the face framed by the double border is smiling, the shutter is automatically released.
- Whenever the camera detects a smiling face, it automatically releases the shutter.

3 End automatic shooting.

- Perform one of the operations listed below to end shooting.
 - Set **Smile timer** to **Off**.
 - Press the 📷 button and select a different shooting mode.





✔ Notes About Smart Portrait Mode

Under some shooting conditions, the camera may be unable to detect faces or detect smiles (📖64). The shutter-release button can also be used for shooting.

When the Self-timer Lamp Flashes

When using smile timer, the self-timer lamp flashes when the camera detects a face and flashes quickly immediately after the shutter is released.

Functions Available in Smart Portrait Mode

- Flash mode (49)
- Self-timer (51)
- Exposure compensation (54)
- Smart portrait menu (57)





(Auto) Mode

Used for general shooting. Settings can be adjusted to suit the shooting conditions and the type of shot you want to capture.

Enter shooting mode →  (shooting mode) button →  (auto) mode → 

- You can change how the camera selects the area of the frame to focus on by changing the **AF area mode** setting (58).
The default setting is **Target finding AF** (63).



Functions Available in (Auto) Mode

- Flash mode (49)
- Self-timer (51)
- Macro mode (53)
- Exposure compensation (54)
- Shooting menu (57)

Using Quick Effects

When in  (auto) mode, you can apply effects to images immediately after releasing the shutter.



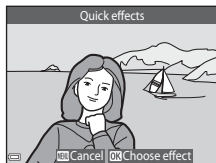

- The edited image is saved as a separate file with a different name.

1 Press the  button when the image is displayed after it is taken in  (auto) mode.

- When you press the **MENU** button or when no operations are performed for about five seconds, the monitor display returns to the shooting screen.
- To not display the screen shown on the right, set **Quick effects** to **Off** in the shooting menu (57).



2 Use the multi selector    to select the desired effect and press the  button.

- Move the zoom control (1) toward **T** () to switch to full-frame playback or **W** () to switch to thumbnail playback.
- To exit without saving the edited image, press the **MENU** button. When a confirmation screen is displayed, select **Yes** and press the  button.
- See "Quick Effects: Changing Hue or Mood" (15) for information about the effect types.

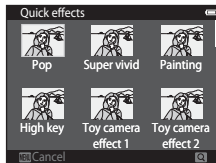

3 Select **Yes** and press the  button.

Using the Self-timer with Gesture Control

When you position the monitor facing forward in the same direction as the camera lens and move your hand toward an icon displayed on the monitor, the shutter is released after a countdown. You can also move your hand toward the other icons to control the zoom position or record a movie. This function is useful when taking self-portrait images or shooting from a short distance.







This function is available in **Portrait** and **Night portrait** scene modes, smart portrait mode, and  (auto) mode.

1 Open the monitor and face it forward in the same direction as the camera lens (📖3).

- A message is displayed for about five seconds, and then  (palm detection) is displayed in the center of the frame.



2 Hold up your hand and align it with in the center of the frame.

- When the camera detects your palm,  changes to  and the icons listed below are displayed in the four corners of the frame.
 - : The camera captures a still image.
 - : The camera starts recording a movie.
 - : The camera zooms out (wide-angle).
 - : The camera zooms in (telephoto).

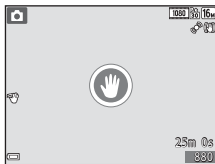

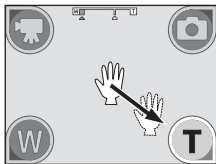

3 Frame the picture.

- To adjust the zoom position, move your hand toward **W** (wide-angle) or **T** (telephoto). The zoom position changes one step at a time.
- If the camera is unable to detect your palm, try step 2 again.



4 Take the picture.

- When you move your hand toward  (to take a still image) or  (to record a movie), the camera releases the shutter after a countdown (about three seconds).
- To end movie recording, press the  (movie-record) button on the camera body. See ["Cutting Unwanted Scenes from Recorded Movies"](#) (p.77).
- When shooting ends, the screen shown in step 2 is displayed again.

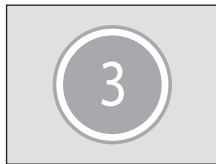
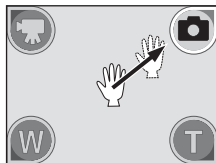





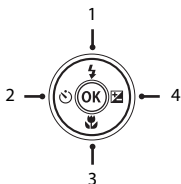

Notes About Gesture Control

- The camera may not detect your palm or hand movement in some shooting conditions.
- When moving your hand, hold up your palm vertically facing the camera, and maintain the same hand shape as you move it.
- Some functions are not available when using the gesture control function (76).

Functions That Can Be Set Using the Multi Selector

The functions that are available vary with the shooting mode, as shown below.



		 (scene auto selector)	Scene	Special effects	Smart portrait	 (auto)
1	 Flash mode (549)	✓*	*	✓	✓*	✓
2	 Self-timer (51)	✓		✓	✓*	✓
3	 Macro (53)	–		✓	–	✓
4	 Exposure compensation (54)	✓		✓	✓	✓

* Availability depends on the setting.

Using the Flash

You can select the flash mode to match the shooting conditions.

- 1 Press the multi selector ▲ (⚡).



- 2 Select the desired flash mode (📖50) and press the OK button.

- If a setting is not applied by pressing the OK button within a few seconds, the selection will be canceled.

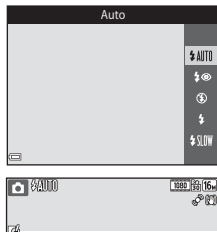

✓ The Flash Lamp

- The status of the flash can be confirmed by pressing the shutter-release button halfway.
 - On: The flash fires when you press the shutter-release button all the way down.
 - Flashing: The flash is charging. The camera cannot shoot images.
 - Off: The flash does not fire when an image is taken.
- If the battery level is low, the monitor turns off while the flash is charging.

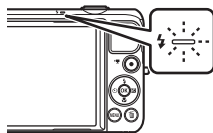

Available Flash Modes

AUTO Auto

The flash fires when necessary, such as in dim lighting.

- The flash mode icon on the shooting screen is displayed only immediately after the setting is made.

Auto with red-eye reduction

Reduce “red-eye” in portraits caused by the flash.

Off

The flash does not fire.

- We recommend using a tripod to stabilize the camera when shooting in dark surroundings.

Fill flash

The flash fires whenever an image is taken. Use to “fill-in” (illuminate) shadows and backlit subjects.

SLOW Slow sync

Suited to evening and night portraits that include background scenery.

The flash fires when necessary to illuminate the main subject; slow shutter speeds are used to capture background at night or under dim lighting.

The Flash Mode Setting

- The setting may not be available with some shooting modes.
- The setting applied in  (auto) mode is saved in the camera’s memory even after the camera is turned off.

Red-eye Reduction

If the camera detects red eye while saving an image, the affected area is processed to reduce red-eye before the image is saved.

Note the following when shooting:

- More time than usual is required to save images.
- Red-eye reduction may not produce the desired results in all situations.
- In some rare cases, red-eye reduction may be applied unnecessarily to other areas of the image. In these cases, select another flash mode and take the image again.

Using the Self-timer

The camera is equipped with a self-timer that releases the shutter about ten seconds or two seconds after you press the shutter-release button.

Set **Vibration reduction** to **Off** in the setup menu (📖78) when using a tripod to stabilize the camera during shooting.

1 Press the multi selector ◀ (⌚).



2 Select ⌚ 10s or ⌚ 2s, and press the Ⓚ button.

- ⌚ 10s (ten seconds): Use on important occasions, such as weddings.
- ⌚ 2s (two seconds): Use to prevent camera shake.
- If a setting is not applied by pressing the Ⓚ button within a few seconds, the selection will be canceled.
- When the shooting mode is **Pet portrait** scene mode, 🐾 (pet portrait auto release) is displayed (📖39). The self-timer cannot be used.



3 Frame the picture and press the shutter-release button halfway.

- Focus and exposure are set.



4 Press the shutter-release button the rest of the way down.

- Countdown starts. The self-timer lamp flashes and then glows steadily about one second before the shutter is released.
- When the shutter is released, the self-timer is set to **OFF**.
- To stop the countdown, press the shutter-release button again.

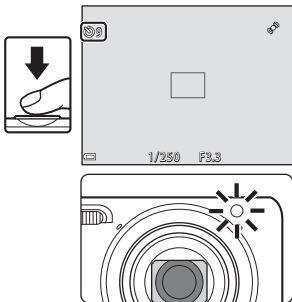

Using Macro Mode

Use macro mode when taking close-up images.

- 1 Press the multi selector ▼ (👉).



- 2 Select **ON** and press the **OK** button.

- If a setting is not applied by pressing the **OK** button within a few seconds, the selection will be canceled.



- 3 Move the zoom control to set the zoom ratio to a position where 📷 and the zoom indicator glow green.



- When the zoom ratio is set to a position where the zoom indicator glows green, the camera can focus on subjects as close as approximately 10 cm (4 in.) from the lens.
When the zoom is at the position where ▲ is displayed, the camera can focus on subjects as close as approximately 2 cm (0.8 in.) from the lens.

👍 Notes About Using the Flash

The flash may be unable to light the entire subject at distances of less than 50 cm (1 ft 8 in.).

📎 The Macro Mode Setting

- The setting may not be available with some shooting modes.
- The setting applied in 📷 (auto) mode is saved in the camera's memory even after the camera is turned off.

Adjusting Brightness (Exposure Compensation)

You can adjust overall image brightness.

- 1 Press the multi selector ► (⊞).



- 2 Select a compensation value and press the OK button.

- To brighten the image, set a positive (+) value.
- To darken the image, set a negative (-) value.
- The compensation value is applied, even without pressing the OK button.



























































Exposure Compensation Value

The setting applied in  (auto) mode is saved in the camera's memory even after the camera is turned off.

Default Settings

Default settings for each shooting mode are described below.

	Flash ( 49)	Self-timer ( 51)	Macro ( 53)	Exposure compensation ( 54)
 (scene auto selector)	 AUTO ¹	Off	Off ²	0.0
Scene				
 (portrait)	 	Off	Off ³	0.0
 (landscape)	 ³	Off	Off ³	0.0
 (sports)	 ³	Off ³	Off ³	0.0
 (night portrait)	  ⁴	Off	Off ³	0.0
 (party/indoor)	  ⁵	Off	Off ³	0.0
 (beach)	 AUTO	Off	Off ³	0.0
 (snow)	 AUTO	Off	Off ³	0.0
 (sunset)	 ³	Off	Off ³	0.0
 (dusk/dawn)	 ³	Off	Off ³	0.0
 (night landscape)	 ³	Off	Off ³	0.0
 (close-up)		Off	On ³	0.0
 (food)	 ³	Off	On ³	0.0
 (museum)	 ³	Off	Off	0.0
 (fireworks show)	 ³	Off ³	Off ³	0.0 ³
 (black and white copy)		Off	Off	0.0

	Flash ( 49)	Self-timer ( 51)	Macro ( 53)	Exposure compensation ( 54)
 (backlighting)	 /  ⁶	Off	Off ³	0.0
 (easy panorama)	 ³	Off ³	Off ³	0.0
 (pet portrait)	 ³	 ⁷	Off	0.0
SO (special effects)	 ³	Off	Off	0.0
 (smart portrait)	 AUTO ⁸	Off ⁹	Off ³	0.0
 (auto)	 AUTO	Off	Off	0.0



¹ The camera automatically selects the flash mode appropriate for the scene it has selected.  (off) can be selected manually.

² Cannot be changed. The camera enters macro mode when  is selected.

³ The setting cannot be changed.

⁴ The setting cannot be changed. The flash mode setting is fixed at fill flash with red-eye reduction.

⁵ Slow sync with red-eye reduction flash mode may be used.

⁶ Flash is fixed at  (fill flash) when **HDR** is set to **Off**, and is fixed at  (off) when **HDR** is set to **On**.

⁷ Self-timer cannot be used. Pet portrait auto release can be turned on or off (39).

⁸ Cannot be used when **Blink proof** is set to **On** or when **Smile timer** is set to **On (continuous)** or **On (BSS)**.

⁹ Can be set when **Smile timer** is set to **Off**.

Functions That Can Be Set with the MENU Button (Shooting Menu)

The settings listed below can be changed by pressing the **MENU** button during shooting (📖4).

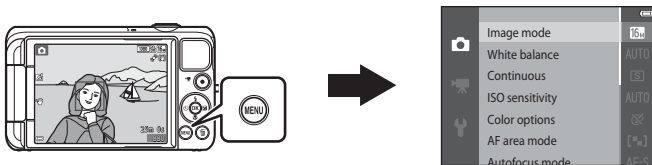













The settings that can be changed vary depending on the shooting mode, as shown below.





	Scene auto selector	Scene ²	Special effects	Smart portrait	Auto mode
Image mode ¹	✓	✓	✓	✓	✓
White balance	-	-	-	-	✓
Continuous	-	-	-	-	✓
ISO sensitivity	-	-	-	-	✓
Color options	-	-	-	-	✓
AF area mode	-	-	-	-	✓
Autofocus mode	-	-	-	-	✓
Quick effects	-	-	-	-	✓
Skin softening	-	-	-	✓	-
Smile timer	-	-	-	✓	-
Blink proof	-	-	-	✓	-

¹ The setting is also applied to other shooting modes.

² Additional settings are available for some scene modes. See "Tips and Notes" (📖35) for more information.

Options Available in the Shooting Menu

Option	Description	
Image mode	Allows you to set the combination of image size and image quality used when saving images. <ul style="list-style-type: none">• Default setting:  4608x3456	 34
White balance	Allows you to adjust white balance to suit the weather conditions or light source in order to make the colors in images match what you see with your eyes. <ul style="list-style-type: none">• Default setting: Auto	 36
Continuous	Allows you to select single or continuous shooting. <ul style="list-style-type: none">• Default setting: Single	 39
ISO sensitivity	Allows you to control the camera's sensitivity to light. <ul style="list-style-type: none">• Default setting: Auto When Auto is selected,  is displayed in the monitor while shooting if ISO sensitivity increases.	 42
Color options	Allows you to change the color tones of images. <ul style="list-style-type: none">• Default setting: Standard color	 43
AF area mode	Allows you to determine how the camera selects the focus area that is used for autofocus. <ul style="list-style-type: none">• Default setting: Target finding AF (63)	 44
Autofocus mode	Allows you to select either Single AF , which focuses only when the shutter-release button is pressed halfway, or Full-time AF , which continues focusing even when the shutter-release button is not pressed halfway. <ul style="list-style-type: none">• Default setting: Single AF	 48
Quick effects	Allows you to enable or disable the quick effects function ( 45). <ul style="list-style-type: none">• Default setting: On	 48

Option	Description	
Skin softening	Allows you to select the skin softening level for human faces. <ul style="list-style-type: none"> • Default setting: Normal 	 49
Smile timer	Allows you to select whether or not the camera automatically releases the shutter when it detects a human smiling face. <ul style="list-style-type: none"> • Default setting: On (BSS) 	 50
Blink proof	The camera automatically releases the shutter twice with every shot and saves one image in which the subject's eyes are open. <ul style="list-style-type: none"> • Default setting: Off 	 51

Functions That Cannot Be Used Simultaneously

Some functions cannot be used with other menu options.

Restricted function	Option	Description
Flash mode	Continuous (📖58)	When a setting other than Single is selected, the flash cannot be used.
	Blink proof (📖59)	When Blink proof is set to On , the flash cannot be used.
	Smile timer (📖59)	When On (continuous) or On (BSS) is selected, the flash cannot be used.
Self-timer	Smile timer (📖59)	When Smile timer is selected, the self-timer cannot be used.
	AF area mode (📖58)	When Subject tracking is selected, the self-timer cannot be used.
Macro mode	AF area mode (📖58)	When Subject tracking is selected, macro mode cannot be used.
Image mode	Continuous (📖58)	Image mode is set as follows depending on the continuous shooting setting: <ul style="list-style-type: none">• Continuous H: 120 fps: VGA (image size: 640 × 480 pixels)• Continuous H: 60 fps: 1M (image size: 1280 × 960 pixels)• Multi-shot 16: 5M (image size: 2560 × 1920 pixels)
White balance	Color options (📖58)	When Black-and-white, Sepia , or Cyanotype is selected, the White balance setting is fixed at Auto .

Restricted function	Option	Description
Continuous	Self-timer (📖51)	If the self-timer is used when Pre-shooting cache is selected, the setting changes to Single .
ISO sensitivity	Continuous (📖58)	When Pre-shooting cache , Continuous H: 120 fps , Continuous H: 60 fps , or Multi-shot 16 is selected, the ISO sensitivity setting is automatically specified according to the brightness.
AF area mode	White balance (📖58)	When a setting other than Auto is selected for White balance in Target finding AF mode, the camera does not detect the main subject.
Quick effects	Continuous (📖58)	The quick effects function cannot be used for images with continuous shooting.
Smile timer	Blink proof (📖59)	When Blink proof is set to On , Smile timer is fixed at On (single) if On (continuous) or On (BSS) is set.
Blink proof	Smile timer (📖59)	When Smile timer is set to On (continuous) or On (BSS) , Blink proof is fixed at Off .
Monitor settings	Quick effects (📖58)	When Quick effects is set to On , Image review is fixed at On .
Print date	Continuous (📖58)	When Pre-shooting cache , Continuous H: 120 fps , or Continuous H: 60 fps is selected, date and time cannot be imprinted on images.

Restricted function	Option	Description
Motion detection	Continuous (📖58)	When a setting other than Single is selected, Motion detection is disabled.
	ISO sensitivity (📖58)	When the ISO sensitivity is set to any setting other than Auto , Motion detection is disabled.
	AF area mode (📖58)	When Subject tracking is selected, Motion detection is disabled.
	Smile timer (📖59)	When On (continuous) or On (BSS) is selected, Motion detection is disabled.
Blink warning	Continuous (📖58)	When a setting other than Single is selected, Blink warning is disabled.
Digital zoom	Continuous (📖58)	When Multi-shot 16 is selected, digital zoom cannot be used.
	AF area mode (📖58)	When Subject tracking is selected, digital zoom cannot be used.
Shutter sound	Continuous (📖58)	When a setting other than Single is selected, the shutter sound is disabled.

✔ Notes About Digital Zoom

- Depending on the shooting mode or the current settings, digital zoom may not be available (📖79).
- When digital zoom is in effect, the camera focuses in the center of the frame.

Focusing

The focus area varies depending on the shooting mode.

Using Target Finding AF

When **AF area mode** (📖 58) in 📷 (auto) mode is set to **Target finding AF**, the camera focuses in the manner described below when you press the shutter-release button halfway.

- The camera detects the main subject and focuses on it.
When the subject is in focus, the focus area glows green. If a human face is detected, the camera automatically sets focus priority on it.
- If no main subject is detected, the camera automatically selects one or more of the nine focus areas containing the subject closest to the camera. When the subject is in focus, the focus areas that are in focus glow green.

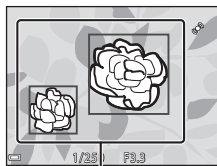

Focus areas

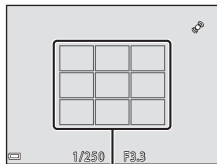

Focus areas

✓ Notes About Target Finding AF

- Depending on shooting conditions, the subject that the camera determines to be the main subject may vary.
- The main subject may not be detected when using certain **White balance** settings.
- The camera may not detect the main subject appropriately in the following situations:
 - When the subject is very dark or bright
 - When the main subject lacks clearly defined colors
 - When the shot is framed so that the main subject is at the edge of the monitor
 - When the main subject is composed of a repeating pattern

Using Face Detection

In the following shooting modes, the camera uses face detection to automatically focus on human faces.

- **SAF** (scene auto selector) mode (📖32)
- **Portrait** or **Night portrait** scene mode (📖34)
- Smart portrait mode (📖42)
- When **AF area mode** (📖58) in **📷** (auto) mode (📖44) is set to **Face priority**.

If the camera detects more than one face, a double border is displayed around the face that the camera focuses on, and single borders are displayed around the other faces.

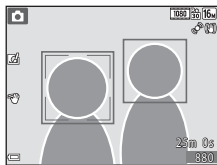

If the shutter button is pressed halfway when no faces are detected:

- In **SAF** (scene auto selector) mode, the focus area changes depending on the scene.
- In **Portrait** and **Night portrait** scene modes or in smart portrait mode, the camera focuses on the area in the center of the frame.
- In **📷** (auto) mode, the camera selects the focus area containing the subject closest to the camera.

✔ Notes About Face Detection

- The camera's ability to detect faces depends on a variety of factors, including the direction in which the faces are looking.
- The camera may be unable to detect faces in the following situations:
 - When faces are partially hidden by sunglasses or otherwise obstructed
 - When faces take up too much or too little of the frame

Using Skin Softening

When the shutter is released while using one of the shooting modes listed below, the camera detects human faces and processes the image to soften facial skin tones (up to three faces).

- Smart portrait mode (📖42)
 - The skin softening level can be adjusted.
-  (scene auto selector) mode (📖32)
- **Portrait** or **Night portrait** scene mode (📖34)

Editing functions such as **Skin softening** can be applied to saved images by using **Glamour retouch** (📖70) even after shooting.

Notes About Skin Softening

- It may take more time than usual to save images after shooting.
- Under some shooting conditions, the desired skin softening results may not be achieved, and skin softening may be applied to areas of the image where there are no faces.

Subjects Not Suitable for Autofocus

The camera may not focus as expected in the following situations. In some rare cases, the subject may not be in focus despite the fact that the focus area or the focus indicator glows green:

- Subject is very dark
- Objects of sharply differing brightness are included in the scene (e.g. the sun behind the subject makes that subject appear very dark)
- No contrast between the subject and surroundings (e.g. a portrait subject wearing a white shirt is standing in front of a white wall)
- Several objects are at different distances from the camera (e.g. the subject is inside a cage)
- Subjects with repeating patterns (window blinds, buildings with multiple rows of similarly shaped windows, etc.)
- Subject is moving rapidly

In the situations noted above, try pressing the shutter-release button halfway to refocus several times, or focus on another subject positioned at the same distance from the camera as the actual desired subject, and use focus lock (📖67).

Focus Lock

Focus lock shooting is recommended when the camera does not activate the focus area that contains the desired subject.

1 Set **AF area mode** to **Center** in  (auto) mode (57).

2 Position the subject in the center of the frame and press the shutter-release button halfway.

- Confirm that the focus area glows green.
- Focus and exposure are locked.

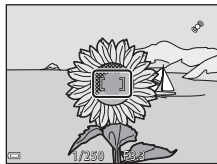

3 Without lifting your finger, recompose the picture.

- Make sure to maintain the same distance between the camera and the subject.

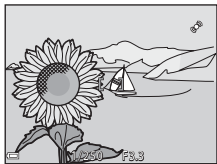

4 Press the shutter-release button the rest of the way down to take the picture.



Playback Features

Playback Zoom

Moving the zoom control toward **T** (Q) in full-frame playback mode (📖28) zooms in on the image.

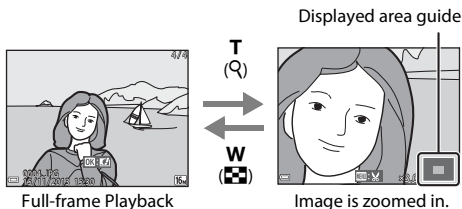

- You can change the zoom ratio by moving the zoom control toward **W** (📐) or **T** (Q).
- To view a different area of the image, press the multi selector ▲▼◀▶.
- If you are viewing an image that was captured using face detection or pet detection, the camera zooms in on the face detected at the time of shooting (except when viewing an image captured in a series). To zoom in on an area of the image where there are no faces, adjust the magnification rate and then press ▲▼◀▶.
- When a zoomed image is displayed, press the **OK** button to return to full-frame playback mode.

Cropping Images

When a zoomed image is displayed, you can press the **MENU** button to crop the image to include only the visible portion and save it as a separate file (🔧21).

Thumbnail Playback, Calendar Display

Moving the zoom control toward **W** (🗉) in full-frame playback mode (📖28) displays images as thumbnails.















- You can change the number of thumbnails displayed by moving the zoom control toward **W** (🗉) or **T** (🔍).
- While using thumbnail playback mode, press the multi selector ▲▼◀▶ to select an image and then press the **OK** button to display that image in full-frame playback mode.
- While using calendar display mode, press ▲▼◀▶ to select a date and then press the **OK** button to display the images captured on that day.









🗒 Calendar Display

Images captured when the camera's date is not set are treated as images captured on January 1, 2013.

Functions That Can Be Set with the MENU Button (Playback Menu)

When viewing images in full-frame playback mode or thumbnail playback mode, you can configure the menu operations listed below by pressing the **MENU** button (.

Option	Description	
Quick retouch*	Allows you to create retouched copies in which contrast and saturation have been enhanced.	 16
D-Lighting*	Allows you to create copies with enhanced brightness and contrast, brightening dark portions of an image.	 16
Red-eye correction*	Corrects "red-eye" that may occur in images when shooting with a flash.	 17
Glamour retouch*	Detects faces in images and retouches the detected faces glamorously.	 18
Print order	Allows you to select which images are printed, and how many copies of each image are printed, prior to printing.	 52
Slide show	Allows you to view images in an automatic slide show.	 56
Protect	Protects selected images from accidental deletion.	 57
Rotate image	Allows you to rotate the displayed image to portrait or landscape orientation.	 59
Small picture*	Creates a small copy of images.	 20
Voice memo	Allows you to use the camera's microphone to record voice memos and attach them to images.	 60

Option	Description	
Copy	Allows you to copy images between the internal memory and a memory card.	 61
Sequence display options	<p>Allows you to select whether to display only the key picture for a sequence of images captured continuously or to display the sequence as individual images.</p> <ul style="list-style-type: none"> When only the key picture is displayed for a sequence, press the  button to display each image in the sequence. Press the multi selector  to return to the key picture display. 	 63
Choose key picture	Allows you to change the key picture for images captured in sequence.	 63
Favorite pictures	Allows you to add images to an album. This option is not displayed in favorite pictures mode.	 66
Remove from favorites	Allows you to remove images from an album. This option is displayed only in favorite pictures mode.	 88

* Edited images are saved as separate files. Some images may not be edited.

Recording and Playing Back Movies

Recording Movies

1 Display the shooting screen.

- Check the remaining amount of movie recording time.
- If **Photo info** in the **Monitor settings** (p.78) in the setup menu is set to **Movie frame+auto info**, the area that will be visible in the movie can be confirmed before movie recording starts.



Movie recording time remaining

2 Press the **MOVIE** (movie-record) button to start movie recording.

- The camera focuses on the subject in the center of the frame.
- Press the multi selector **▶** to pause recording, and press **▶** again to resume recording (except when **iFrame 720/30p** (iFrame **iFrame 720/25p**) or an HS movie option is selected in **Movie options**). Recording automatically ends if it remains paused for about five minutes.

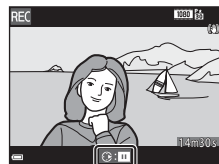
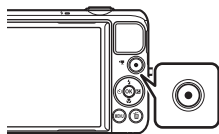

3 Press the **MOVIE** (movie-record) button again to end recording.

✔ Maximum Movie Length

Individual movie files cannot exceed 4 GB in size or 29 minutes in length, even when there is sufficient free space on the memory card for longer recording.

- The maximum movie length for a single movie is displayed on the shooting screen.
- Recording may end before either limit is reached if camera temperature becomes elevated.
- The actual movie length may vary depending on the movie content, subject movement, or type of memory card.

✔ Notes About Saving Images and Recording Movies

The indicator showing the number of exposures remaining or the indicator showing the maximum movie length flashes while images are being saved or while a movie is being recorded. **Do not open the battery-chamber/memory card slot cover or remove the battery or memory card** while an indicator is flashing. Doing this could result in loss of data, or in damage to the camera or the memory card.

✔ Notes About Movie Recording



- Memory cards with an SD Speed Class rating of 6 or faster are recommended when recording movies (U22). Movie recording may stop unexpectedly when memory cards with a lower Speed Class rating are used.
- There may be some degradation in image quality when digital zoom is used.
- The sounds of zoom control operation, zoom, autofocus lens drive movement, vibration reduction, and aperture operation when brightness changes may be recorded.
- The following phenomena may be seen in the monitor while recording movies. These phenomena are saved in the recorded movies.
 - Banding may occur in images under fluorescent, mercury-vapor, or sodium-vapor lighting.
 - Subjects that move quickly from one side of the frame to the other, such as a moving train or car, may appear skewed.
 - The entire movie image may be skewed when the camera is panned.
 - Lighting or other bright areas may leave residual images when the camera is moved.
- Depending on the distance to the subject or the amount of zoom applied, subjects with repeating patterns (fabrics, lattice windows, etc.) may have colored stripes (interference patterns, moiré, etc.) in them during movie recording and playback. This occurs when the pattern in the subject and the layout of the image sensor interfere with each other; it is not a malfunction.

Camera Temperature

- The camera may become warm when shooting movies for an extended period of time or when the camera is used in a hot area.
- If the inside of the camera becomes extremely hot when recording movies, the camera will automatically stop recording.
The amount of time remaining until the camera stops recording ( 10s) is displayed.
After the camera stops recording, it turns itself off.
Leave the camera off until the inside of the camera has cooled.

Notes About Autofocus

Autofocus may not perform as expected ( 66). Should this occur, try the following:





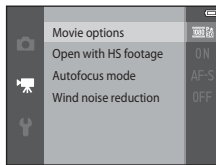

1. Set **Autofocus mode** in the movie menu to **Single AF** (default setting) before starting movie recording.
2. Frame another subject—positioned at the same distance from the camera as the intended subject—in the center of the frame, press the  ( movie-record) button to start recording, and then modify the composition.

Functions That Can Be Set with the MENU Button (Movie Menu)

Enter shooting mode → MENU button →  menu icon →  button

The settings of the menu options listed below can be configured.



Option	Description	
Movie options	Select the movie type. Select normal speed to record movies at normal speed, or HS (high speed) to record movies that play in slow or fast motion. • Default setting:  1080★/30p  1080★/25p	 64
Open with HS footage	Set whether to start recording at high speed or normal speed when recording HS movies. • Default setting: On	 68
Autofocus mode	Select either Single AF , which locks focus when movie recording begins, or Full-time AF , which continues focusing during movie recording. • Default setting: Single AF	 68
Wind noise reduction	Set whether or not to reduce wind noise during movie recording. • Default setting: Off	 69

Playing Back Movies

Press the  button to enter playback mode.

Movies are indicated by the movie options icon ()75).

Press the  button to play back movies.

- To adjust the volume, move the zoom control ()1).



Movie options

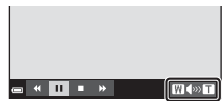

Volume indicator

Functions Available During Playback

Playback controls are displayed at the bottom of the monitor. The operations listed below can be performed by using the multi-selector ◀▶ to select a control and then pressing the OK button.



Function	Icon	Description
Rewind	⏮	Hold down the OK button to rewind the movie.
Advance	⏭	Hold down the OK button to advance the movie.
Pause	⏸	Pause playback. The operations listed below can be performed while paused.
		⏮ Rewind the movie one frame. Hold down the OK button for continuous rewinding.
		⏭ Advance the movie one frame. Hold down the OK button for continuous advancing.
		▶ Resume playback.
	✂	Extract the desired portion of a movie and save it as a separate file.
End	⏹	Return to full-frame playback mode.

✂ Cutting Unwanted Scenes from Recorded Movies

If a movie recorded using the gesture control function contains an unwanted scene of you stopping the recording (📖47), pause the movie during playback and follow the steps below to edit it.

1. Select ✂ in the playback controls, and then press the OK button.
2. Select ✂ (choose end point) in the editing controls.
3. Select 📁 (save) and press the OK button.

Deleting movies

To delete a movie, select the desired movie in full-frame playback mode (📖28) or thumbnail playback mode (📖69) and press the 🗑 button (📖30).







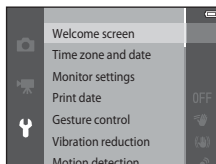

General Camera Setup

















Functions That Can Be Set with the MENU Button (Setup Menu)

Press the MENU button →  (setup) menu icon →  button

The settings of the menu options listed below can be configured.



Option	Description	
Welcome screen	Allows you to select whether or not the welcome screen is displayed when the camera is turned on.	 70
Time zone and date	Allows you to set the camera clock.	 71
Monitor settings	Allows you to adjust photo information display, post-shooting image review, and monitor brightness settings.	 73
Print date	Allows you to imprint the shooting date and time on images.	 75
Gesture control	Allows you to set whether or not the gesture control function ( 46) is enabled when you position the monitor facing forward in the same direction as the camera lens.	 76
Vibration reduction	Allows you to select the vibration reduction setting used when shooting.	 77

Option	Description	
Motion detection	Allows you to set whether or not the camera automatically increases the shutter speed to reduce blurring caused by camera shake if motion is detected when shooting still images.	 78
AF assist	Allows you to enable or disable the AF-assist illuminator.	 79
Digital zoom	Allows you to enable and disable digital zoom.	 79
Sound settings	Allows you to adjust sound settings.	 80
Auto off	Allows you to set the amount of time that passes before the monitor turns off to save power.	 80
Format memory/ Format card	Allows you to format the internal memory or the memory card.	 81
Language	Allows you to change the camera's display language.	 82
TV settings	Allows you to adjust TV-connection settings.	 82
Charge by computer	Allows you to set whether or not the battery in the camera is charged when the camera is connected to a computer.	 83
Blink warning	Allows you to set whether or not closed eyes are detected when taking images of people using face detection.	 84
Wi-Fi options	Allows you to configure the Wi-Fi (wireless LAN) settings to connect the camera and a smart device. See "Using the Wi-Fi (Wireless LAN) Function" ( 80) for more information.	 85
Eye-Fi upload	Allows you to set whether or not to enable the function for sending images to a computer using a commercially available Eye-Fi card.	 87
Reset all	Allows you to reset the camera's settings to their default values.	 88
Firmware version	View the current camera firmware version.	 88

Using the Wi-Fi (Wireless LAN) Function

Functions That Can Be Performed Using Wi-Fi

You can perform the following functions if you install the dedicated software “Wireless Mobile Utility” on your smart device that runs on Android OS or iOS, and connect it to the camera.

Take Photos

You can take still images using the two methods described below.

- Release the shutter on the camera and save the captured images to a smart device.
- Use a smart device to remotely* release the camera shutter and save images to the smart device.
 - * Operations cannot be performed on the camera during remote control operation.

View Photos

You can copy the pictures saved in the camera’s memory card to your smart device.

Installing the Software on the Smart Device

- 1** Use your smart device to connect to Google Play Store, App Store or other online apps marketplace and search for “Wireless Mobile Utility.”
 - Check the user’s manual provided with your smart device for further details.
- 2** Check the description and other information and install the software.
 - For more information about how to operate the software, download the user’s manual from the website below.
 - Android OS: <http://nikonimglib.com/ManDL/WMAU/>
 - iOS: <http://nikonimglib.com/ManDL/WMAU-ios/>

Connecting the Smart Device to the Camera

Press the **MENU** button → **Y** menu icon → Wi-Fi options → **OK** button

- 1 Use the multi selector **▲▼** to select the **Wi-Fi network** and press the **OK** button.

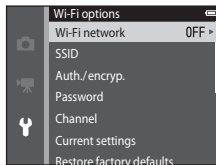

- 2 Select **On** and press the **OK** button.

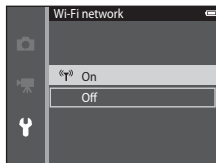

- SSID and the password are displayed.
- If no connection confirmation is received from the smart device within 3 minutes, the setting returns to **Off**.

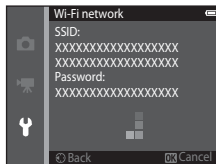

3 Set the Wi-Fi setting on the smart device to On.

- Check the user's manual provided with your smart device for further details.
- After the network name (SSID) that can be used for the smart device is displayed, select the SSID displayed on the camera.
- When the message for entering a password is displayed, enter the password that is displayed on the camera.
- When the camera is successfully connected to a Wi-Fi network, the shooting screen is displayed with the Wi-Fi icon (📶7).

4 Start the dedicated software installed on the smart device.

- The screen for selecting "Take photos" or "View photos" is displayed.
- When the message "Cannot connect to camera." is displayed, retry the **Wi-Fi network** setting.

To Terminate the Wi-Fi Connection

- Turn off the camera.
- Set the Wi-Fi setting on the smart device to Off.

✔ Notes About Wi-Fi Connection

- Set the **Wi-Fi network** to **Off** in a place where the use of radio waves is prohibited.
- When a memory card is not inserted in the camera, the Wi-Fi function cannot be used. When Eye-Fi card (📷87) is inserted in the camera, the Wi-Fi function cannot be used.
- When Wi-Fi is connected, **Auto off** is disabled.
- When the **Wi-Fi network** is set to **On**, the battery drains faster than normal.
- The **Wi-Fi network** cannot be selected when the battery level indicator in the monitor indicates 📶. In addition, if the battery level indicator indicates 📶 while a Wi-Fi connection is established, the connection is terminated.

📎 Notes About Security Settings

If the camera is installed with the Wi-Fi function without proper security settings (encryption and password), unauthorized third parties may access the network and cause harm. We strongly recommend performing the required security settings before using the Wi-Fi function.

Use **Wi-Fi options** of the setup menu (📖79) to perform the security settings.

Connecting the Camera to a TV, Computer, or Printer

Connection Methods

You can enhance your enjoyment of images and movies by connecting the camera to a TV, computer, or printer.

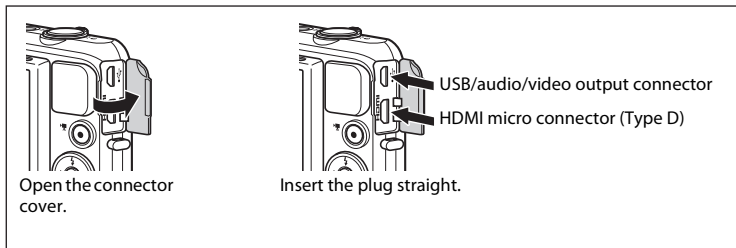

- Before connecting the camera to an external device, make sure the remaining battery level is sufficient and turn the camera off. Before disconnecting, make sure to turn the camera off.
- If the AC Adapter EH-62G (available separately) is used, this camera can be powered from an electrical outlet. Do not use any other make or model of AC adapter as it may cause the camera to heat up or malfunction.
- For information about the connection methods and subsequent operations, refer to the documentation included with the device in addition to this document.

Viewing images on a TV

82



Images and movies captured with the camera can be viewed on a TV. Connection method: Connect the video and audio plugs of an optional audio video cable to the TV's input jacks. Alternatively, connect a commercially available HDMI cable to the TV's HDMI input jack.

Viewing and organizing images on a computer

85



You can transfer images to a computer to perform simple retouching and manage image data.

Connection method: Connect the camera to the computer's USB port with the USB cable.

- Before connecting to a computer, install ViewNX 2 on the computer (85). For information about using the ViewNX 2 CD-ROM and transferring images to a computer, see page 85.
- If any USB devices that draw the power from the computer are connected, disconnect them from the computer before you connect the camera to it. Connecting the camera and other USB-powered devices to the same computer simultaneously may cause a camera malfunction or excessive power supply from the computer, which could damage the camera or memory card.

Printing images without using a computer

25



If you connect the camera to a PictBridge-compatible printer, you can print images without using a computer.

Connection method: Connect the camera directly to the printer's USB port with the USB cable.

Using ViewNX 2

ViewNX 2 is an all-in-one software package which enables you to transfer, view, edit and share images. Install ViewNX 2 using the included ViewNX 2 CD-ROM.



Installing ViewNX 2

- An Internet connection is required.

Compatible Operating Systems

Windows

Windows 8, Windows 7, Windows Vista, Windows XP

Macintosh

Mac OS X10.6, 10.7, 10.8

Refer to the Nikon website for details on system requirements, including the latest information on operating system compatibility.

1 Start the computer and insert the ViewNX 2 CD-ROM into the CD-ROM drive.

- Windows: If instructions for operating the CD-ROM are displayed in the window, follow the instructions to proceed to the installation window.
- Mac OS: When the **ViewNX 2** window is displayed, double-click the **Welcome** icon.

2 Select a language in the language selection dialog to open the installation window.

- If the desired language is not available, click **Region Selection** to choose a different region and then choose the desired language (the **Region Selection** button is not available in the European release).
- Click **Next** to display the installation window.

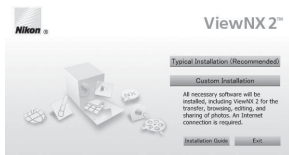

3 Start the installer.

- We recommend clicking **Installation Guide** in the installation window to check the installation help information and system requirements before installing ViewNX 2.
- Click **Typical Installation (Recommended)** in the installation window.

4 Download the software.

- When the **Software Download** screen is displayed, click **I agree - Begin download**.
- Follow the on-screen instructions to install the software.

5 Exit the installer when the installation completion screen is displayed.

- Windows: Click **Yes**.
- Mac OS: Click **OK**.

The following software is installed:

- ViewNX 2 (consisting of the three modules below)
 - Nikon Transfer 2: For transferring images to the computer
 - ViewNX 2: For viewing, editing, and printing transferred images
 - Nikon Movie Editor: For basic editing of transferred movies
- Panorama Maker (for creating a single panorama image of a landscape, etc. from a series of images that each capture a separate portion of the subject)

6 Remove the ViewNX 2 CD-ROM from the CD-ROM drive.

Transferring Images to the Computer

1 Choose how images will be copied to the computer.

Choose one of the following methods:

- **Direct USB connection:** Turn the camera off and ensure that the memory card is inserted in the camera. Connect the camera to the computer using the USB cable. The camera automatically turns on.
To transfer images that are saved in the camera's internal memory, remove the memory card from the camera before connecting it to the computer.

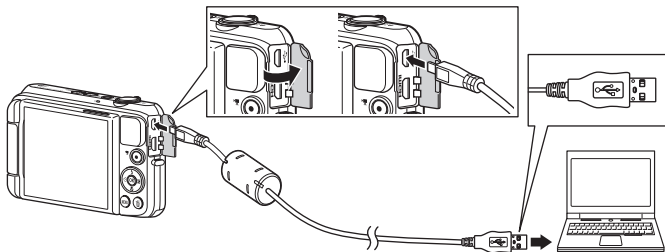

- **SD card slot:** If your computer is equipped with an SD card slot, the card can be inserted directly in the slot.
- **SD card reader:** Connect a card reader (available separately from third-party suppliers) to the computer and insert the memory card.

If a message is displayed prompting you to choose a program, select Nikon Transfer 2.

- **When using Windows 7**

If the dialog shown at right is displayed, follow the steps below to select Nikon Transfer 2.

- 1 Under **Import pictures and videos**, click **Change program**. A program selection dialog will be displayed; select **Import File using Nikon Transfer 2** and click **OK**.
- 2 Double-click **Import File**.



If the memory card contains a large number of images, it may take a while for Nikon Transfer 2 to start. Wait until Nikon Transfer 2 starts.

✓ Connecting the USB Cable

The connection may not be recognized if the camera is connected to the computer via a USB hub.

2 Transfer images to the computer.

- Confirm that the name of the connected camera or removable disk is displayed as the "Source" on the "Options" title bar of Nikon Transfer 2 (①).
- Click **Start Transfer** (②).

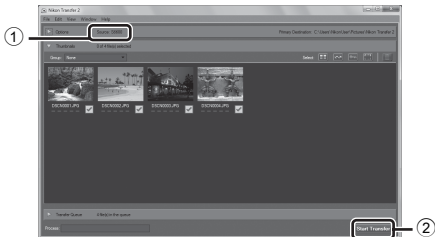

- At default settings, all the images on the memory card will be copied to the computer.

3 Terminate the connection.

- If the camera is connected to the computer, turn the camera off and disconnect the USB cable. If you are using a card reader or card slot, choose the appropriate option in the computer operating system to eject the removable disk corresponding to the memory card and then remove the card from the card reader or card slot.

Viewing Images

Start ViewNX 2.

- Images are displayed in ViewNX 2 when transfer is complete.
- Consult online help for more information on using ViewNX 2.



Starting ViewNX 2 Manually

- **Windows:** Double-click the **ViewNX 2** shortcut on the desktop.
- **Mac OS:** Click the **ViewNX 2** icon in the Dock.



Reference Section

The Reference Section provides detailed information and hints about using the camera.

Shooting

Using Easy Panorama (Shooting and Playback)	2
---	---

Playback

Favorite Pictures Mode	6
Auto Sort Mode	10
List by Date Mode	11
Viewing and Deleting Images Captured Continuously (Sequence)	12
Editing Still Images	14
Connecting the Camera to a TV (Viewing Images on a TV)	22
Connecting the Camera to a Printer (Direct Print)	24
Editing Movies	32

Menu











The Shooting Menu (for (Auto) Mode)	34
The Smart Portrait Menu	49
The Playback Menu	52
The Movie Menu	64
The Setup Menu	70

Additional Information

Error Messages	89
File Names	94
Optional Accessories	95

Using Easy Panorama (Shooting and Playback)

Shooting with Easy Panorama

Enter shooting mode →  (shooting mode) button →  (second icon from the top*)
→        (easy panorama) →  button

* The icon of the last scene selected is displayed.

1 Select **Normal (180°)** or **Wide (360°)** as the shooting range and press the  button.

- When the camera is readied in the horizontal position, the image size (width × height) is as follows.
 - **Normal (180°)**: 4800 × 920 when moved horizontally, 1536 × 4800 when moved vertically
 - **Wide (360°)**: 9600 × 920 when moved horizontally, 1536 × 9600 when moved vertically

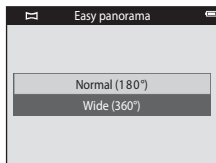

2 Frame the first edge of the panorama scene, and then press the shutter-release button halfway to focus.

- The zoom position is fixed at wide-angle position.
- The camera focuses on the area in the center of the frame.

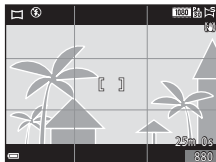

- 3** Press the shutter-release button all the way, and then remove your finger from the shutter-release button.

- △▽◀▶ are displayed to indicate the direction of camera movement.



- 4** Move the camera in one of the four directions until the guide indicator reaches the end.

- When the camera detects which direction it is moving in, shooting begins.

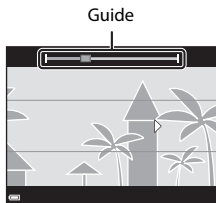

Example of camera movement

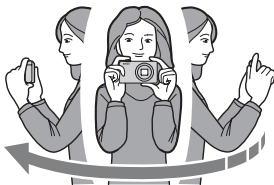

- Using your body as the axis of rotation, move the camera slowly in an arc, in the direction of the marking (△▽◀▶).
- Shooting stops if the guide does not reach the edge within about 15 seconds (when **Normal (180°)** is selected) or within about 30 seconds (when **Wide (360°)** is selected) after shooting starts.

Notes About Easy Panorama Shooting

- The range of the image seen in the saved image is narrower than that seen in the monitor at the time of shooting.
- If the camera is moved too quickly or shaken too much, or if the subject is too uniform (e.g. walls or darkness), an error may occur.
- If shooting is stopped before the camera reaches the half-way point in the panorama range, a panorama image is not saved.
- If more than half of the panorama range is captured but shooting ends before reaching the edge of the range, the range not captured is recorded and displayed in gray.

Viewing Images Captured with Easy Panorama

Switch to playback mode (📖28), display an image captured using easy panorama in full-frame playback mode, and then press the **OK** button to scroll the image in the direction that was used when shooting.

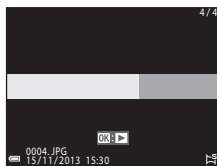

Playback controls are displayed at the bottom of the monitor during playback. Use the multi selector **◀▶** to select a control, and then press the **OK** button to perform the following operations.

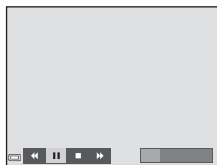

Function	Icon	Description	
Rewind	◀◀	Hold down the OK button to scroll backward quickly.	
Advance	▶▶	Hold down the OK button to scroll forward quickly.	
Pause		Pause playback. The operations listed below can be performed while paused.	
		◀◀	Hold down the OK button to rewind.
		▶▶	Hold down the OK button to scroll.
		▶	Resume automatic scrolling.
End	■	Switch to full-frame playback mode.	

✓ Notes About Scroll Playback

This camera may not be able to scroll the playback of, or zoom in on, easy panorama images captured with another make or model of digital camera.

Favorite Pictures Mode







By adding images (except movies) to albums as favorite pictures, you can play back only the added images.

- Images can be sorted into nine albums. Up to 200 images can be added to each album.
- The original images are not copied or moved.
- The same image can be added to multiple albums.

Adding Images to Albums

Press the  button (playback mode) → MENU button → Favorite pictures →  button

1 Use the multi selector   to select an image and use  to display .

- You can add  to multiple images. To remove , press .
- Move the zoom control () toward **T** () to switch to full-frame playback or **W** () to switch to thumbnail playback.



2 Press the  button after configuring the settings.

3 Select the desired album and press the  button.

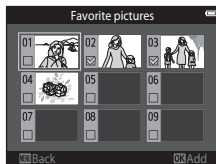

- The selected images are added.



Playing Back Images in Albums

Press the  button (playback mode) →  button →  Favorite pictures →  button

Use the multi selector to select an album and then press the  button to play back the images in the selected album.

- Functions in the playback menu () can be used for the images in the selected album (except **Copy** and **Favorite pictures**).
- The following operations are available from the album selection screen.
 - **MENU** button: Changes the album icon ()9).
 -  button: Deletes all original images added to the selected album.

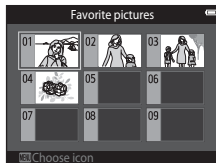

Notes About Deletion

If an image is deleted while using favorite pictures mode, the original image is deleted. When removing images from albums, see “Removing Images from Albums” ()8).

Removing Images from Albums

Enter **F** Favorite pictures mode → select the album containing the image you want to remove → **OK** button → **MENU** button → Remove from favorites → **OK** button

1 Use the multi selector **◀▶** to select an image and use **▲** to hide **F**.

- To display the icons again, press **▼**.
- Move the zoom control (**□1**) toward **T** (**Q**) to switch to full-frame playback or **W** (**⊞**) to switch to thumbnail playback.



2 Press the **OK** button after configuring the settings.

3 Select **Yes** and press the **OK** button.

- To cancel removal, select **No**.

Changing the Favorites Album Icon

Press the button (playback mode) → button → Favorite pictures → button

- 1 Use the multi selector to select an album and press the **MENU** button.

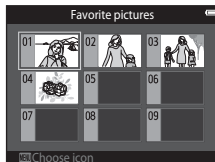

- 2 Use to select an icon color and press the button.

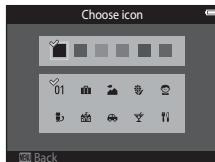



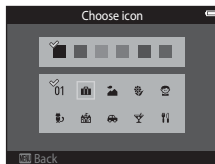

- 3 Select an icon and press the button.
 - The icon changes.





Auto Sort Mode

Images are automatically sorted into categories, such as portraits, landscapes, and movies, based on the camera settings at the time of shooting.

Press the  button (playback mode) →  button →  Auto sort →  button

Use the multi selector to select a category and then press the  button to play back the images in the selected category.

- Functions in the playback menu (70) can be used for the images in the selected category (except **Copy** and **Remove from favorites**).
- While the category selection screen is displayed, press the  button to delete all original images in the selected category.

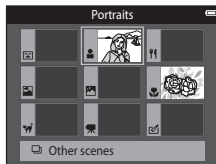

Notes About Auto Sort Mode

- Up to 999 images and movie files can be sorted into each category in auto sort mode.
- Images or movies saved by cameras other than this camera cannot be played back in auto sort mode.

List by Date Mode

Press the  button (playback mode) →  button →  List by date →  button





Use the multi selector to select a date and then press the  button to play back the images captured on the selected date.

- Functions in the playback menu (70) can be used for the images in the selected shooting date (except **Copy** and

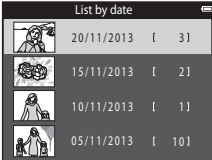
Remove from favorites).

- The following operations are available while the shooting date selection screen is displayed.
 - **MENU** button: The functions listed below are available.
 - Print order*
 - Slide show
 - Protect*
 - * The same settings can be applied to all images captured on the selected date.
 -  button: Deletes all images captured on the selected date.



List by date		
	20/11/2013	[3]
	15/11/2013	[2]
	10/11/2013	[1]
	05/11/2013	[10]

Notes About List by Date Mode

- Up to the most recent 29 dates can be selected. If images exist for more than 29 dates, all images saved earlier than the most recent 29 dates will be combined under **Others**.
- The 9,000 most recent images can be displayed.
- Images captured when the camera's date is not set are treated as images captured on January 1, 2013.

Viewing and Deleting Images Captured Continuously (Sequence)

Viewing Images in a Sequence

Images captured continuously are saved as a sequence.

The first image of a sequence is used as the key picture to represent the sequence when displayed in full-frame playback mode or thumbnail playback mode (default setting).

To display each image in the sequence individually, press the **OK** button.

After pressing the **OK** button, the operations listed below are available.

- To display the previous or next image, press the multi selector ◀▶.
- To display images that are not included in the sequence, press ▲ to return to the key picture display.
- To display images in a sequence as thumbnails, or to play them back in a slide show, set **Sequence display options** to **Individual pictures** in the playback menu (663).



✓ Sequence Display Options

Images captured continuously with cameras other than this camera cannot be displayed as a sequence.



Playback Menu Options Available When Using Sequence

- When images in a sequence are displayed in full-frame playback mode, press the **MENU** button to select functions in playback menu (📖70).
 - If you press the **MENU** button when a key picture is displayed, the following settings can be applied to all images in the sequence:
 - Favorite pictures, Print order, Protect, Copy
-

Deleting Images in a Sequence

When the  button is pressed for images in a sequence, the images that are deleted vary depending on how the sequences are displayed.

- When the key picture is displayed:
 - **Current image:** All images in the displayed sequence are deleted.
 - **Erase selected images:** When a key picture is selected on the erase selected images screen (📖31), all images in that sequence are deleted.
 - **All images:** All images in the internal memory or on the memory card are deleted.
- When images in a sequence are displayed in full-frame playback mode:
 - **Current image:** The image currently displayed is deleted.
 - **Erase selected images:** Images that are selected in the sequence are deleted.
 - **Entire sequence:** All images in the displayed sequence are deleted.

Editing Still Images

Before Editing Images

You can easily edit images on this camera. Edited copies are saved as separate files. Edited copies are saved with the same shooting date and time as the original.

Restrictions on Image Editing

When an edited copy is further modified with another editing function, check the following restrictions.

Editing function used	Editing functions to use
Quick effects Quick retouch D-Lighting	The glamour retouch, small picture, or crop function can be used.
Red-eye correction	Editing functions cannot be used.
Glamour retouch	The quick effects, quick retouch, D-Lighting, small picture, or crop function can be used.
Small picture Crop	Editing functions cannot be used. When using in combination with other editing functions, use the small picture or crop function after the other editing functions have been applied.

- Copies created with editing functions cannot be further edited with the same function used to create them.

Quick Effects: Changing Hue or Mood

Quick Effects Option	Description
Pop and Super vivid	Mainly enhances the color saturation.
Painting, High key, Toy camera effect 1, Toy camera effect 2, Low key, Cross process (red), Cross process (yellow), Cross process (green), and Cross process (blue)	Mainly adjusts hue and creates a different look for the image.
Soft portrait, Fisheye, Cross screen, and Miniature effect	Processes images with a variety of effects.
High-contrast monochrome, Sepia, Cyanotype, and Selective color	Turns multicolor images into single color images. Selective color transforms all colors, except a specified color, to black and white.

- 1 Display the image to which you want to apply an effect in full-frame playback mode and press the **OK** button.



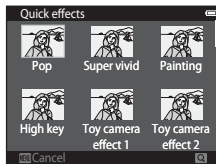

- 2 Use the multi selector **▲▼◀▶** to select the desired effect and press the **OK** button.

- Move the zoom control (**□1**) toward **T** (**Q**) to switch to full-frame playback or **W** (**☒**) to switch to thumbnail playback.
- To exit without saving the edited image, press the **MENU** button.



- 3 Select **Yes** and press the **OK** button.
 - An edited copy is created.

Quick Retouch: Enhancing Contrast and Saturation



Press the  button (playback mode) → select an image → MENU button → Quick retouch →  button

Use the multi selector   to select the amount of effect applied and press the  button.

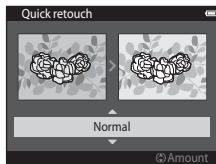
- The edited version is displayed on the right.
- To exit without saving the copy, press .



D-Lighting: Enhancing Brightness and Contrast



Press the  button (playback mode) → select an image → MENU button → D-Lighting →  button

Use the multi selector   to select **OK** and press the  button.

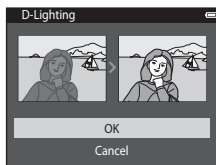
- The edited version is displayed on the right.
- To exit without saving the copy, select **Cancel** and press the  button.



Red-eye Correction: Correcting Red-eye When Shooting with the Flash

Press the  button (playback mode) → select an image → MENU button → Red-eye correction →  button

Preview the result and press the  button.

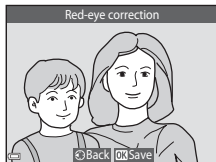

- To exit without saving the copy, press the multi selector .







Notes About Red-eye Correction

- Red-eye correction can only be applied to images when red-eye is detected.
- Red-eye correction can be applied to pets (dogs or cats) even if their eyes are not red.
- Red-eye correction may not produce the desired results in some images.
- In some rare cases, red-eye correction may be applied unnecessarily to other areas of the image.





Glamour Retouch: Enhancing Human Faces



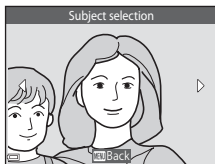





Press the  button (playback mode) → select an image → MENU button → Glamour retouch → 

1 Use the multi selector     to select the face that you want to retouch and press the .

- When only one face is detected, proceed to step 2.



2 Use   to select the effect, use   to select the effect level, and press the .

- You can simultaneously apply multiple effects. Adjust or check the settings for all effects before pressing the .
-  (skin softening),  (small face),  (big eyes),  (brighten faces),  (hide eye bags),  (whiten eyes),  (whiten teeth),  (redden cheeks)
- Press the MENU button to return to the screen for selecting a face.

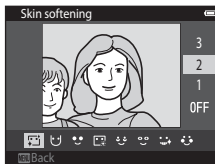

3 Preview the result and press the .

- To change the settings, press  to return to step 2.
- To exit without saving the edited image, press the MENU button.

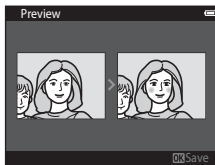

4 Select **Yes** and press the **OK** button.

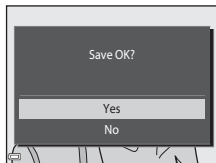

- An edited copy is created.







✓ Notes About Glamour Retouch

- Only one face per image can be edited using the glamour retouch function.
- Depending upon the direction in which faces are looking, or the brightness of faces, the camera may be unable to accurately detect faces, or the glamour retouch function may not perform as expected.
- If no faces are detected, a warning is displayed and the screen returns to the playback menu.
- The glamour retouch function is available only for images captured when the ISO sensitivity is 1600 or lower.

Small Picture: Reducing the Size of an Image

Press the  button (playback mode) → select an image → MENU button → Small picture →  button

1 Use the multi selector   to select the desired copy size and press the  button.

- Images taken at an image mode setting of  **4608×2592** are saved at 640 × 360 pixels. Proceed to step 2.

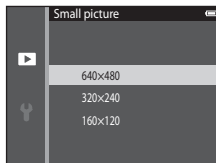

2 Select **Yes** and press the  button.

- An edited copy is created (compression ratio of approximately 1:16).

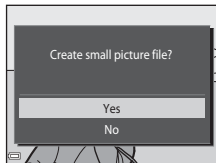

Crop: Creating a Cropped Copy

1 Move the zoom control to enlarge the image (📖68).

2 Refine copy composition and press the **MENU** button.

- Move the zoom control toward **T** (📏) or **W** (📐) to adjust the zoom ratio. Set a zoom ratio at which **MENU**:🗑️ is displayed.
- Use the multi selector ▲▼◀▶ to scroll the image so that only the portion to be copied is visible in the monitor.



3 Select **Yes** and press the **OK** button.

- An edited copy is created.



Image Size

When the image size of the cropped copy is 320 x 240 or smaller, the image is displayed at a smaller size during playback.

Cropping the Image in Its Current "Tall" Orientation

Use the **Rotate image** option (🔄59) to rotate the image so that it is displayed in landscape orientation. After cropping the image, rotate the cropped image back to "tall" orientation.

Connecting the Camera to a TV (Viewing Images on a TV)

1 Turn off the camera and connect it to the TV.

- Make sure that the plugs are properly oriented. Do not insert or remove the plugs at an angle when connecting or disconnecting them.

When using an audio video cable

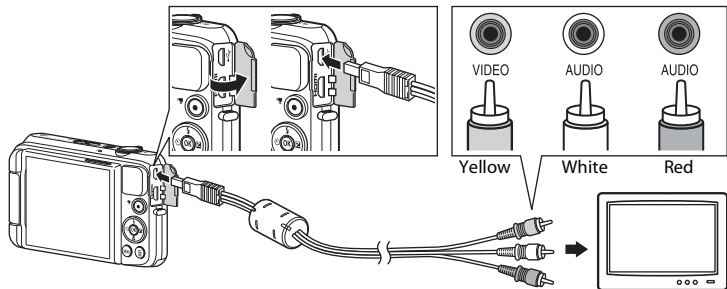

When using an HDMI cable

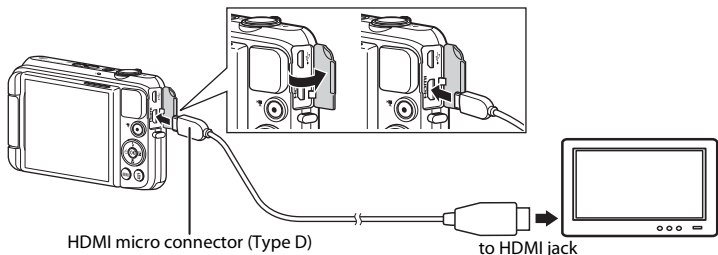

2 Set the TV's input to external video input.

- See the documentation provided with your TV for details.

3 Hold down the button to turn on the camera.

- Images are displayed on the TV.
- The camera monitor does not turn on.

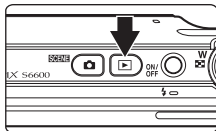

If Images Are Not Displayed on the TV

Make sure that **TV settings** ()82) in the setup menu conforms to the standard used by your TV.

Using a TV Remote Control (HDMI Device Control)

The remote control of an HDMI-CEC-compatible TV can be used to select images, start and pause movie playback, switch between full-screen playback mode and four-image thumbnail display, etc.

- Set the **HDMI device control** setting ()82) of **TV settings** to **On** (default setting) and then connect the camera and TV using an HDMI cable.
- Aim the remote control at the TV when operating it.

Connecting the Camera to a Printer (Direct Print)

Users of PictBridge-compatible printers can connect the camera directly to the printer and print images without using a computer.

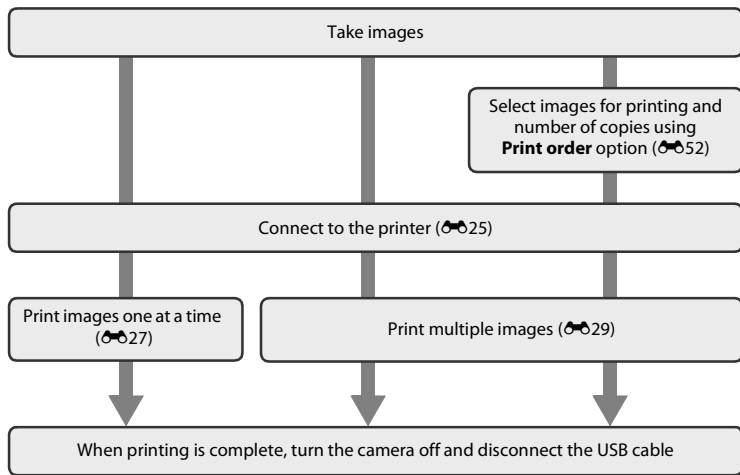

Connecting the Camera to a Printer

- 1 Turn off the camera.
- 2 Turn on the printer.
 - Check printer settings.
- 3 Connect the camera to the printer using the USB cable.
 - Make sure that the plugs are properly oriented. Do not insert or remove the plugs at an angle when connecting or disconnecting them.

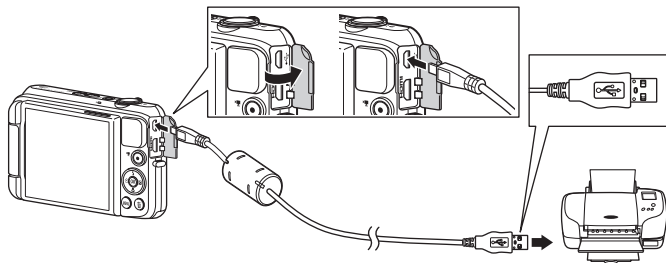

4 The camera is automatically turned on.

- The **PictBridge** startup screen (①) is displayed in the camera monitor, followed by the **Print selection** screen (②).

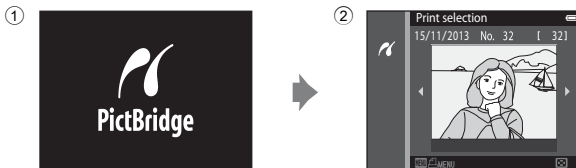

✔ If the PictBridge Startup Screen Is not Displayed

When **Auto** is selected for **Charge by computer** (083), it may be impossible to print images with direct connection of the camera to some printers. If the PictBridge startup screen is not displayed after the camera is turned on, turn the camera off and disconnect the USB cable. Set **Charge by computer** to **Off** and reconnect the camera to the printer.

Printing Individual Images

1 Use the multi selector to select the desired image and press the **OK** button.

- Move the zoom control toward **W** (🗉) to switch to thumbnail playback or **T** (🖼️) to switch to full-frame playback.



2 Use **▲▼** to select **Copies** and press the **OK** button.

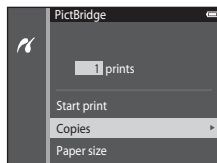

3 Select the desired number of copies (up to nine) and press the **OK** button.



4 Select **Paper size** and press the **OK** button.

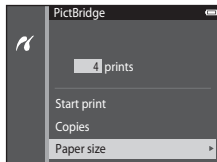

5 Select the desired paper size and press the **OK** button.

- To apply the paper size setting configured on the printer, select **Default** as the paper size option.
- The paper size options available on the camera vary depending on the printer that you use.

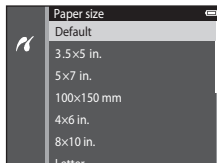

6 Select **Start print** and press the **OK** button.

- Printing starts.
- To cancel printing, press the **OK** button.

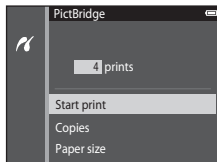

Printing Multiple Images

- 1 When the **Print selection** screen is displayed, press the **MENU** button.

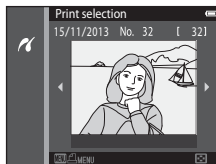

- 2 Use the multi selector ▲▼ to select **Paper size** and press the **OK** button.

- To exit the print menu, press the **MENU** button.

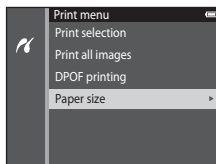

- 3 Select the desired paper size and press the **OK** button.

- To apply the paper size setting configured on the printer, select **Default** in the paper size option.
- The paper size options available on the camera vary depending on the printer that you use.

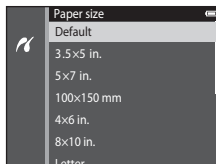

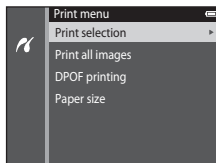

4 Select **Print selection**, **Print all images**, or **DPOF printing** and press the **OK** button.



Print selection

Select images (up to 99) and the number of copies (up to nine) of each.

- Use the multi selector **◀▶** to select images, and use **▲▼** to specify the number of copies to be printed.
- Images selected for printing are indicated by  and the numeral indicating the number of copies to be printed. If no copies have been specified for images, the selection is canceled.
- Move the zoom control toward **T** () to switch to full-frame playback or **W** () to switch to thumbnail playback.
- Press the **OK** button when setting is complete.
- When the screen shown on the right is displayed, select **Start print** and press the **OK** button to start printing.

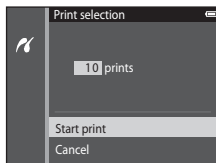
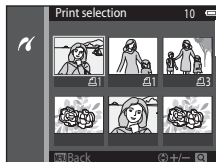

Print all images

One copy each of all images saved in the internal memory, or on the memory card, is printed.

- When the screen shown on the right is displayed, select **Start print** and press the **OK** button to start printing.

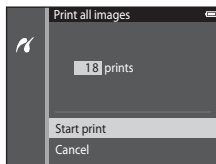

DPOF printing

Print images for which a print order was created using the **Print order** option (52).

- When the screen shown on the right is displayed, select **Start print** and press the **OK** button to start printing.

To view the current print order, select **View images** and press the **OK** button. To print images, press the **OK** button again.

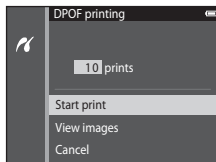

Editing Movies

The desired portions of a recorded movie can be saved as a separate file.

1 Play back the desired movie and pause at the start point of the portion that is to be extracted (📖76).

2 Use the multi selector ◀▶ to select 🎞️ in the playback controls, and then press the ⏹️ button.

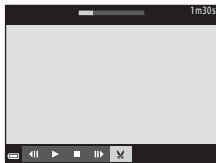

3 Use ▲▼ to select 🎞️ (choose start point) in the editing controls.

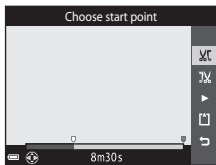

- Use ◀▶ to move the start point.
- To cancel editing, select ↵ (return), and press the ⏹️ button.

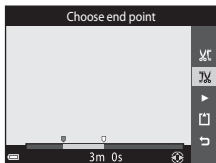

4 Use ▲▼ to select 🎞️ (choose end point).

- Use ◀▶ to move the end point.
- To preview the specified portion, select ▶ and then press the ⏹️ button. Press the ⏹️ button again to stop previewing.





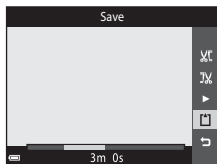

5 Use ▲▼ to select  (save) and press the  button.

- Follow the instructions on the screen to save the movie.



 Notes About Movie Editing

- Movies recorded using  **iFrame 720/30p** ( **iFrame 720/25p**) ( H.264) cannot be edited.
- Use a sufficiently charged battery to prevent the camera from turning off during editing. When the battery level indicator is , movie editing is not possible.
- A movie that was created by editing cannot be trimmed again.
- The actual trimmed portion of a movie may differ slightly from the portion selected using the start and end points.
- Movies cannot be trimmed so that they are less than two seconds long.

The Shooting Menu (for (Auto) Mode)

Image Mode Settings (Image Size and Quality)

Enter shooting mode → MENU button → Image mode →  button

Select the combination of image size and compression ratio that is used when saving images. The higher the image mode setting, the larger the size at which it can be printed, and the lower the compression ratio, the higher the quality of the images, but the number of images that can be saved is reduced.

Option*	Compression ratio	Aspect ratio (horizontal to vertical)
16M* 4608×3456★	Approx. 1/4	4:3
16M 4608×3456 (default setting)	Approx. 1/8	4:3
8M 3264×2448	Approx. 1/8	4:3
4M 2272×1704	Approx. 1/8	4:3
2M 1600×1200	Approx. 1/8	4:3
VGA 640×480	Approx. 1/8	4:3
Hi-9 12M 4608×2592	Approx. 1/8	16:9
1:1 3456×3456	Approx. 1/8	1:1

* The total number of pixels captured, and the number of pixels captured horizontally and vertically.

Example: **16M 4608×3456** = approx. 16 megapixels, 4608 × 3456 pixels



Notes About Image Mode

- The image mode setting can also be changed in shooting modes other than auto. The changed setting is also applied to other shooting modes.
- The setting may not be changed when using certain settings of other functions.



Number of Images That Can Be Saved

- The approximate number of images that can be saved can be checked in the monitor when shooting (📖20).
- Note that due to JPEG compression, the number of images that can be saved may vary greatly depending on the image content, even when using memory cards with the same capacity and the same image mode setting. In addition, the number of images that can be saved may vary depending on the make of the memory card.
- If the number of exposures remaining is 10,000 or more, the number of exposures remaining display shows “9999”.



Printing Images at 1:1 Aspect Ratio







Change the printer setting to “Border” when printing images at a 1:1 aspect ratio. Some printers may not be able to print images at a 1:1 aspect ratio.

White Balance (Adjusting Hue)



Select  (auto) mode → MENU button → White balance →  button

Adjust white balance to suit the light source or weather conditions in order to make the colors in images match what you see with your eyes.

- Use **Auto** under most conditions. Change the setting when you want to adjust the hue of the image you are taking.

Option	Description
AUTO Auto (default setting)	White balance is automatically adjusted to suit lighting conditions.
PRE Preset manual	Use when the desired result is not achieved with Auto , Incandescent , etc. ( 37).
 Daylight	White balance adjusted for direct sunlight.
 Incandescent	Use under incandescent lighting.
 Fluorescent	Use under fluorescent lighting.
 Cloudy	Use when taking images under overcast skies.
 Flash	Use with the flash.

Notes About White Balance

- Set the flash to  (off) when white balance is set to any setting other than **Auto** and **Flash** (49).
- The setting may not be changed when using certain settings of other functions.

Using Preset Manual

Use the procedure below to measure the white balance value under the lighting used during shooting.

1 Place a white or gray reference object under the lighting that will be used during shooting.

2 Use the multi selector ▲▼ to select **Preset manual** in the **White balance** menu, and press the **OK** button.

- The camera zooms in to the position for measuring white balance.

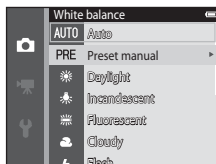

3 Select **Measure**.

- To apply the last measured value, select **Cancel** and press the **OK** button.

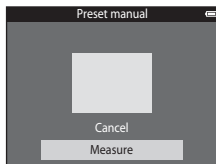

4 Frame the reference object in the measuring window.

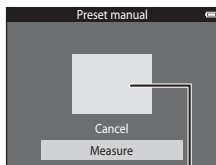

Measuring window



5 Press the button to measure the value.











- The shutter is released and measurement is complete. No image is saved.



Notes About Preset Manual

A value for flash lighting cannot be measured with **Preset manual**. When shooting using the flash, set **White balance** to **Auto** or **Flash**.

Continuous Shooting

Select  (auto) mode → MENU button → Continuous →  button

Option	Description
 Single (default setting)	One image is taken each time the shutter-release button is pressed.
 Continuous H	While the shutter-release button is held all the way down, images are captured continuously. <ul style="list-style-type: none">The frame rate for continuous shooting is about 10 fps and the maximum number of continuous shots is about 7 (when image mode is set to  4608×3456).
 Continuous L	While the shutter-release button is held all the way down, images are captured continuously. <ul style="list-style-type: none">The frame rate for continuous shooting is about 2 fps and the maximum number of continuous shots is about 6 (when image mode is set to  4608×3456).
 Pre-shooting cache	When the shutter-release button is pressed halfway, pre-shooting cache shooting begins. When the shutter-release button is pressed the rest of the way down, the camera saves the current image as well as the images captured immediately before the button is pressed (). This function helps you to avoid missing the shot. <ul style="list-style-type: none">The frame rate for continuous shooting is about 10 fps and the maximum number of continuous shots is 5, including a maximum of two frames captured in the pre-shooting cache (when image mode is set to  4608×3456).
 120 Continuous H: 120 fps	Each time the shutter-release button is pressed all the way, images are captured at a high speed rate. <ul style="list-style-type: none">The frame rate for continuous shooting is about 120 fps and the maximum number of continuous shots is 50.Image mode is fixed at  (image size: 640 × 480 pixels).

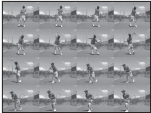
Option	Description
 60 Continuous H: 60 fps	<p>Each time the shutter-release button is pressed all the way, images are captured at a high speed rate.</p> <ul style="list-style-type: none"> • The frame rate for continuous shooting is about 60 fps and the maximum number of continuous shots is 25. • Image mode is fixed at 1M (image size: 1280 × 960 pixels).
BSS BSS (Best Shot Selector)	<p>While the shutter-release button is held all the way down, the camera captures a series of up to ten images and automatically saves the sharpest image.</p> <p>Use when shooting a stationary subject in a place where flash photography is prohibited and camera shake is likely to occur.</p>
 Multi-shot 16	<p>Each time the shutter-release button is pressed all the way down, the camera captures a series of 16 images and saves it as a single image.</p> <ul style="list-style-type: none"> • The frame rate for continuous shooting is about 30 fps. • Image mode is fixed at 5M (image size: 2560 × 1920 pixels). • Digital zoom cannot be used. 

Notes About Continuous Shooting

- When a setting other than **Single** is selected, the flash cannot be used. Focus, exposure, and white balance are fixed at the values determined with the first image in each series.
- It may take some time to save the images after shooting.
- When ISO sensitivity increases, noise may appear in captured images.
- The frame rate for continuous shooting may vary depending upon the current image mode setting, the memory card used, or shooting condition.
- When using **Pre-shooting cache**, **Continuous H: 120 fps**, **Continuous H: 60 fps**, or **Multi-shot 16**, banding or variance in brightness or hue may occur in images that were captured under lighting that flickers at high speeds, such as fluorescent, mercury-vapor, or sodium-vapor lighting.
- The setting may not be changed when using certain settings of other functions.

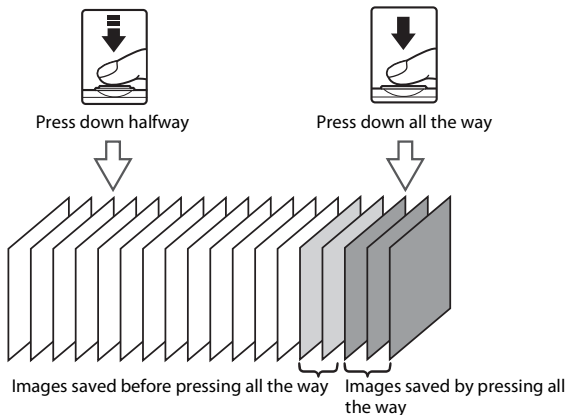

Pre-shooting Cache

When the shutter-release button is pressed halfway or all the way down, images are saved in the manner described below.



- The pre-shooting cache icon (📷) in the monitor glows green while the shutter-release button is pressed halfway.

ISO Sensitivity

Select  (auto) mode → MENU button → ISO sensitivity → 

Higher ISO sensitivity allows darker subjects to be captured. Additionally, even with subjects of similar brightness, images can be taken at faster shutter speeds, and blurring caused by camera shake and subject movement can be reduced.

- When higher ISO sensitivity is set, images may contain noise.

Option	Description
AUTO Auto (default setting)	Sensitivity is automatically selected from the range of ISO 125 to 1600.
 Fixed range auto	Select the range in which the camera automatically adjusts ISO sensitivity, from ISO 125-400 or ISO 125-800 .
125, 200, 400, 800, 1600, 3200, Hi 1	Sensitivity is locked at the specified value. <ul style="list-style-type: none">• Hi 1 is equivalent to ISO 6400.



Notes About ISO Sensitivity

The setting may not be changed when using certain settings of other functions.





ISO Sensitivity Display on the Shooting Screen

- When **Auto** is selected, **ISO** is displayed if the ISO sensitivity automatically increases.
- When **Fixed range auto** is selected, the maximum value for ISO sensitivity is displayed.

Color Options

Select  (auto) mode → MENU button → Color options →  button



Make colors more vivid or save images in monochrome.

Option	Description
 Standard color (default setting)	Use for images exhibiting natural color.
 Vivid color	Use to achieve a vivid, “photoprint” effect.
 Black-and-white	Save images in black-and-white.
 Sepia	Save images in sepia tones.
 Cyanotype	Save images in cyan-blue monochrome.

Notes About Color Options

The setting may not be changed when using certain settings of other functions.

AF Area Mode

Select  (auto) mode → MENU button → AF area mode → 

Use this option to determine how the camera selects the focus area for autofocus.

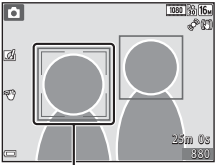
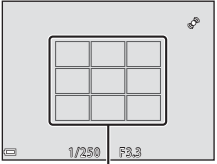
Option	Description
 Face priority	<p>When the camera detects a human face, it focuses on that face. See “Using Face Detection” (p.64) for more information.</p>  <p>Focus area</p> <p>When framing a composition with no human subjects or detected faces, the camera automatically selects one or more of the nine focus areas containing the subject closest to the camera when the shutter-release button is pressed halfway.</p>  <p>Focus areas</p>

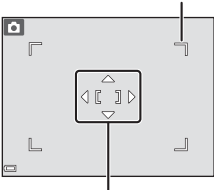
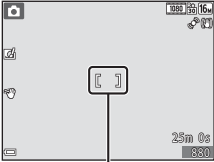
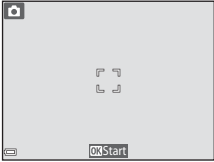

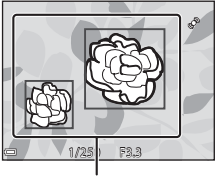

Option	Description	
<p>[] Manual</p>	<p>Use the multi selector ▲▼◀▶ to move the focus area to where you want to focus.</p> <ul style="list-style-type: none"> To use the multi selector to configure the flash mode or other settings, press the OK button. To return to moving the focus area, press the OK button again. 	<p>Scope of movable focus area</p>  <p>Focus area</p>
<p>[] Center</p>	<p>The camera focuses on the subject in the center of the frame.</p>	 <p>Focus area</p>
<p>Ⓞ Subject tracking</p>	<p>Use this function to take images of moving subjects. Register the subject on which the camera focuses. The focus area automatically moves to track the subject. See "Using Subject Tracking" (p.47) for more information.</p>	

Option	Description
<p> Target finding AF (default setting)</p>	<p>When the camera detects the main subject, it focuses on that subject. See "Using Target Finding AF" (p.63) for more information.</p>  <p style="text-align: center;">Focus areas</p>



Notes About AF Area Mode

- When digital zoom is in effect, the camera focuses on the area in the center of the frame regardless of the **AF area mode** setting.
- The setting may not be changed when using certain settings of other functions.

Using Subject Tracking

Select  (auto) mode → MENU button → AF area mode →  button →  Subject tracking →  button → MENU button

1 Register a subject.

- Align the subject that you want to track with the border in the center of the monitor and press the  button.
- When the subject is registered, a yellow border (focus area) is displayed around that subject and the camera begins tracking that subject.
- If the subject cannot be registered, the border glows red. Change the composition and try registering the subject again.
- To cancel subject registration, press the  button.
- If the camera can no longer track the registered subject, the focus area disappears. Register the subject again.

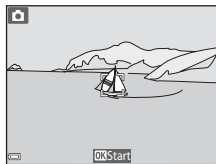

2 Press the shutter-release button fully to take the picture.

- If the shutter-release button is pressed while the focus area is not displayed, the camera focuses on the area in the center of the frame.

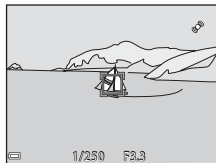

Notes About Subject Tracking

- If you perform operations such as zooming while the camera is tracking the subject, the registration is canceled.
- Subject tracking may not be possible in certain shooting conditions.

Autofocus Mode

Select  (auto) mode → MENU button → Autofocus mode →  button

Select how the camera focuses when shooting still images.





Option	Description
AF-S Single AF (default setting)	The camera focuses only when the shutter-release button is pressed halfway.
AF-F Full-time AF	The camera continues focusing even when the shutter-release button is not pressed halfway. The sound of lens drive movement is heard while the camera focuses.

Autofocus Mode for Movie Recording

Autofocus mode for movie recording can be set with **Autofocus mode** (68) in the movie menu.

Quick Effects

Select  (auto) mode → MENU button → Quick effects →  button

Option	Description
 On (default setting)	In  (auto) mode, press the  button immediately after releasing the shutter to display the effect selection screen and use the quick effects function ( 45).
Off	Disables the quick effects function (during shooting).

Notes About Quick Effects

The setting may not be changed when using certain settings of other functions.

The Smart Portrait Menu

- See “Image Mode Settings (Image Size and Quality)” (📷34) for information about **Image mode**.





Skin Softening

Enter shooting mode → 📷 (shooting mode) → 😊 Smart portrait → Ⓜ button → MENU button → Skin softening → Ⓜ button



Option	Description
↕ High	When the shutter is released, the camera detects one or more human faces (up to three), and processes the image to soften facial skin tones before saving the image. You can select the amount of effect that is applied.
↕ Normal (default setting)	
↕ Low	
Off	Turns skin softening off.

The effects of skin softening are not visible when framing images for shooting. Check the results in playback mode, after taking images.

Smile Timer

Enter shooting mode →  (shooting mode) →  Smart portrait →  button → MENU button → Smile timer →  button





The camera detects human faces and then automatically releases the shutter whenever a smile is detected.

Option	Description
 On (single)	Whenever a smile is detected, the camera captures one image.
 On (continuous)	Whenever a smile is detected, the camera captures up to 5 images continuously and saves them all. The flash cannot be used.
 BSS On (BSS) (default setting)	Whenever a smile is detected, the camera captures up to 5 images continuously and saves the one that best captured the smile. The flash cannot be used.
Off	Turns the smile timer off.

Notes About Smile Timer

The setting may not be changed when using certain settings of other functions.

Blink Proof

Enter shooting mode →  (shooting mode) →  Smart portrait →  button → MENU button → Blink proof →  button

Option	Description
 On	<p>The camera automatically releases the shutter twice with every shot and saves one image in which the subject's eyes are open.</p> <ul style="list-style-type: none">• If the camera saved an image in which the subject's eyes may have been closed, the dialog shown on the right is displayed for a few seconds.• The flash cannot be used.
Off (default setting)	Turns the blink proof off.

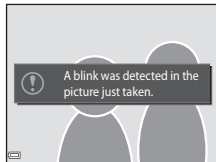

Notes About Blink Proof

The setting may not be changed when using certain settings of other functions.

The Playback Menu

- See “Editing Still Images” (📷14) for information about image editing functions.
- See “Favorite Pictures Mode” (📷6) for information about **Favorite pictures** and **Remove from favorites**.

Print Order (Creating a DPOF Print Order)

Press the  button (playback mode) → MENU button → Print order →  button

If you configure print order settings in advance, you can use them with the printing methods listed below.

- Taking the memory card to a digital photo lab that supports DPOF (Digital Print Order Format) printing.
- Inserting the memory card into a DPOF-compatible printer’s card slot.
- Connecting the camera to a PictBridge-compatible printer (📷24).

1 Use the multi selector ▲▼ to select **Select images** and press the button.

- In favorite pictures, auto sort, or list by date mode, the screen shown on the right is not displayed. Proceed to the step 2.

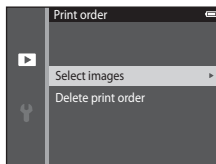

2 Select images (up to 99) and the number of copies (up to nine) of each.

- Use the multi selector ◀▶ to select images, and use ▲▼ to specify the number of copies to be printed.
- Images selected for printing are indicated by 🖨️ and the numeral indicating the number of copies to be printed. If no copies have been specified for images, the selection is canceled.
- Move the zoom control toward **T** (🔍) to switch to full-frame playback or **W** (🖼️) to switch to thumbnail playback.
- Press the **OK** button when setting is complete.



3 Select whether or not to print shooting date and shooting information.

- Select **Date** and press the **OK** button to print the shooting date on all images.
- Select **Info** and press the **OK** button to print the shutter speed and aperture value on all images.
- Lastly, select **Done** and press the **OK** button to complete the print order.

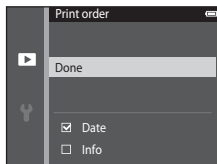

Notes About Print Order

When a print order is created in favorite pictures mode, auto sort mode, or list by date mode, the screen shown below is displayed if images other than those in the selected album, category, or shooting date have been marked for printing.

- **Yes:** Does not remove print markings from other images, and adds the current print order settings.
- **No:** Removes print markings from all other images, and uses only the current print order settings.

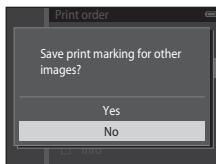

Favorite pictures mode or auto sort mode

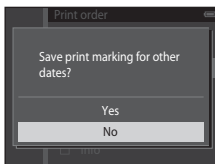

List by date mode

If the total number of the images in the print order exceeds 99 when the new settings are applied, the screen shown below is displayed.

- **Yes:** Removes print markings from all other images, and uses only the current print order settings.
- **Cancel:** Does not remove print markings from other images, and cancels the current print order settings.

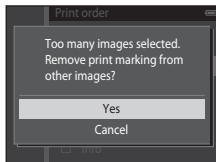

Favorite pictures mode or auto sort mode

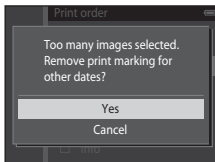

List by date mode

✓ Notes About Printing Shooting Date and Shooting Information

- Some printers may not be able to print the shooting date and shooting information.
- Shooting information is not printed when the camera is connected to a printer.
- The **Date** and **Info** settings are reset each time the **Print order** option is displayed.
- The date printed is that saved when the image was captured.
- For images taken with the **Print date** (🔑75) option enabled, only the date and time imprinted at the time of shooting are printed, even if the **Print order** date option is enabled for the images.



🔗 Canceling Existing Print Order

Select **Delete print order** in step 1 of "Print Order (Creating a DPOF Print Order)" (🔑52).

🔗 More Information



See "Printing Images at 1:1 Aspect Ratio" (🔑35) for more information.

Slide Show

Press the  button (playback mode) → MENU button → Slide show →  button



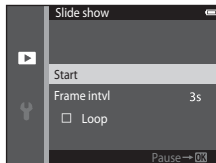

Play back images one by one in an automated “slide show.” When movie files are played back in the slide show, only the first frame of each movie is displayed.

1 Use the multi selector to select **Start** and press the .

- The slide show begins.
- To change the interval between images, select **Frame intvl**, press the , and specify the desired interval time before selecting **Start**.
- To repeat the slide show automatically, select **Loop** and press the  before selecting **Start**.
- The maximum playback time is up to about 30 minutes even if **Loop** is enabled.





2 Select End or Restart.



- The screen shown on the right is displayed after the slide show ends or is paused. To exit the show, select  and then press the  button. To resume the slide show, select  and then press the .



Operations During Playback

- Use   to display the previous/next image. Press and hold to rewind/fast forward.
- Press the  button to pause or end the slide show.

Protect

Press the  button (playback mode) → MENU button → Protect →  button

The camera protects selected images from accidental deletion.

Select images to protect or cancel protection for previously protected images from the image selection screen (58).

Note that formatting the camera's internal memory or the memory card permanently deletes protected files (81).

The Image Selection Screen

When an image selection screen such as the one shown on the right is displayed while operating the camera, follow the procedures described below to select the images.

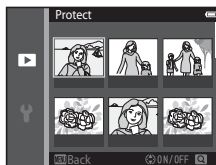

1 Use the multi selector ◀▶ to select an image.

- Move the zoom control (□1) toward **T** (📷) to switch to full-frame playback or **W** (📐) to switch to thumbnail playback.
- Only one image can be selected for **Rotate image**, **Choose key picture**, and **Welcome screen**. Proceed to step 3.

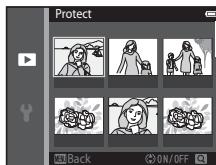

2 Use ▲▼ to select or deselect (or to specify the number of copies).

- When an image is selected, an icon is displayed below the image. Repeat steps 1 and 2 to select additional images.

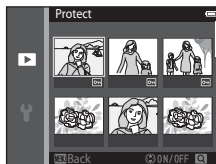



3 Press the (OK) button to apply image selection.

- When **Selected images** is selected, a confirmation dialog is displayed. Follow the instructions displayed in the monitor.

Rotate Image

Press the  button (playback mode) → MENU button → Rotate image →  button

Specify the orientation in which saved images are displayed during playback. Still images can be rotated 90 degrees clockwise or 90 degrees counterclockwise.

Select an image from the image selection screen (58). When the Rotate image screen is displayed, press the multi selector  to rotate the image 90 degrees.

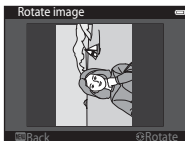

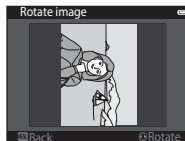

Rotate 90 degrees
counterclockwise



Rotate 90 degrees
clockwise





Press the  button to finalize display orientation, and save orientation information with the image.

Voice Memo

Press the  button (playback mode) → select an image → MENU button → Voice memo →  button

Voice memos can be recorded and attached to images.

Recording Voice Memos

- Press and hold the  button to record (up to about 20 seconds).
- Do not touch the microphone.
- During recording, **REC** and  flash in the monitor.
- The voice memo playback screen is displayed after recording ends. Press the  button to play back the voice memo.
- Delete the current voice memo before recording a new voice memo (61).
-  is displayed for images with a voice memo when in full-frame playback mode.





Playing Voice Memos

Select an image with  displayed before pressing the MENU button.

- Press the  button to play the voice memo. Press the button again to stop playback.
- Move the zoom control during playback to adjust playback volume.



Deleting Voice Memos



Press the  button while the screen described in "Playing Voice Memos" () is displayed.

When the confirmation dialog is displayed, use the multi selector   to select **Yes** and press the  button.

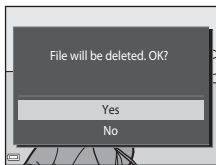

- To delete a voice memo for a protected image, the **Protect** setting must first be disabled.



Copy (Copy Between Internal Memory and Memory Card)

Press the  button (playback mode) → MENU button → Copy →  button

Copy images between the internal memory and a memory card.

- 1 Use the multi selector   to select a destination option to which images are copied and press the  button.

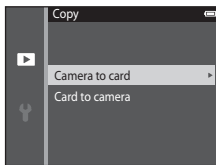

2 Select a copy option and press the **OK** button.

- If you choose the **Selected images** option, use the image selection screen to specify images (📷58).

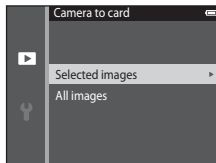

✔ Notes About Copying Images

- Only files in formats that this camera can record can be copied.
- Operation is not guaranteed with images captured with another make of camera or that have been modified on a computer.
- The **Print order** (📷52) settings configured for images are not copied.
- Copied images or movies cannot be displayed in auto sort mode (📷10).
- If an image added to an album (📷6) is copied, the copied image is not added to the album.

📎 Notes About Copying Images in a Sequence

- If you select a key picture of a sequence in **Selected images**, all images in the sequence are copied.
- If you press the **MENU** button while images in a sequence are displayed, only the **Card to camera** copy option is available. All images in the sequence are copied if you select **Current sequence**.



📎 Copying to a Memory Card That Contains No Images

When the camera is switched to playback mode, **Memory contains no images.** is displayed. Press the **MENU** button to select **Copy**.

Sequence Display Options



Press the  button (playback mode) → MENU button → Sequence display options →  button

Select the method used to display images in the sequence (12).

Option	Description
 Individual pictures	Displays each image in a sequence individually.  is displayed on the playback screen.
 Key picture only (default setting)	Displays only the key picture for images in a sequence.

Settings are applied to all sequences, and the setting is saved in the camera's memory even if the camera is turned off.

Choose Key Picture

Press the  button (playback mode) → display a sequence for which you want to change the key picture → MENU button → Choose key picture →  button

Specify a different image in the sequence as the key picture.

- When the key picture selection screen is displayed, select an image (58).

The Movie Menu

Movie Options













Enter shooting mode → MENU button →  menu icon → Movie options →  button

Select the desired movie option to record.

Select normal speed movie options to record at normal speed, or HS movie options () to record in slow or fast motion.

- Memory cards (Class 6 or higher) are recommended for recording movies (:22).

Normal Speed Movie Options



Option (Image size/Frame rate ¹ , File format)	Image size	Aspect ratio (horizontal to vertical)
 1080★/30p  1080★/25p (default setting)	1920×1080 (High)	16:9
 1080/30p  1080/25p	1920×1080	16:9
 1080/60i  1080/50i	1920×1080	16:9
 720/30p  720/25p	1280×720	16:9
 iFrame 720/30p ²  iFrame 720/25p ²	1280×720	16:9
 480/30p  480/25p	640×480	4:3

- The items and frame rate that can be set vary depending on the **Video mode** setting in **TV settings** in the setup menu (82).
- iFrame is a format supported by Apple Inc. iFrame files cannot be edited on this camera. When recording movies to the internal memory, recording may stop before the maximum movie length is reached.

HS Movie Options

Recorded movies are played back in fast or slow motion.

See “Recording Movies in Slow Motion and Fast Motion (HS Movie)” (66).

Option	Image size Aspect ratio (horizontal to vertical)	Description
 HS 480/4x	640×480 4:3	1/4-speed slow motion movies <ul style="list-style-type: none"> Max. recording time*: 10 seconds (playback time: 40 seconds)
 HS 720/2x	1280×720 16:9	1/2-speed slow motion movies <ul style="list-style-type: none"> Max. recording time*: 30 seconds (playback time: 1 minute)
 HS 1080/0.5x	1920×1080 16:9	2× speed fast motion movies <ul style="list-style-type: none"> Max. recording time*: 2 minutes (playback time: 1 minute)

- * While recording movies, the camera can be switched between normal speed movie recording and slow motion or fast motion movie recording.
The maximum recording time shown here refers only to the portion of the movie that is recorded in slow motion or fast motion.



Notes About HS Movie

- Sound is not recorded.
- Zoom position, focus, exposure, and white balance are locked when movie recording starts.
- Some **Movie options** settings are not available when using certain special effects.

Recording Movies in Slow Motion and Fast Motion (HS Movie)

Enter shooting mode → MENU button →  menu icon → Movie options →  button



Movies recorded using HS movie can be played back in slow motion at 1/4 or 1/2 of the normal playback speed, or in fast motion at twice the normal playback speed.

- 1 Use the multi selector  to select an HS movie option () and press the  button.

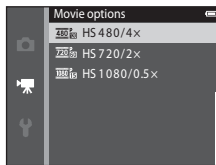
- After applying the option, press the MENU button to return to the shooting screen.



- 2 Press the  (movie-record) button to start recording.

- Movie recording starts at high speed when the **Open with HS footage** option in the movie menu is set to **On**, or at normal speed when it is set to **Off**.
- The camera switches between normal speed movie recording and HS movie recording each time the  button is pressed.
- The movie options icon changes when switching between HS movie recording and normal speed movie recording.
- When the maximum recording time for HS movies () is reached, the camera automatically switches to normal speed movie recording.

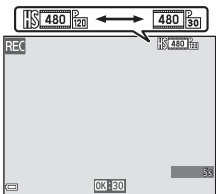

- 3 Press the  (movie-record) button to end recording.

Playing Back in Slow Motion and Fast Motion

When recording at normal speed:

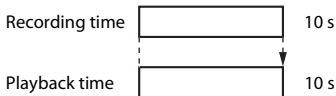

When recording at $\frac{480}{\text{FPS}}$ HS 480/4 \times ($\frac{480}{\text{FPS}}$ HS 480/4 \times):

Movies are recorded at 4 \times normal speed.

They are played back in slow motion at 4 \times slower speed.

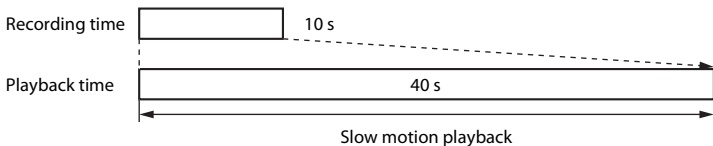



When recording at $\frac{1080}{\text{FPS}}$ HS 1080/0.5 \times ($\frac{1080}{\text{FPS}}$ HS 1080/0.5 \times):

Movies are recorded at 1/2 normal speed.

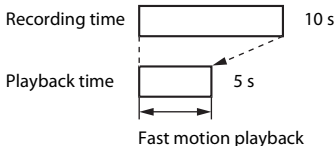
They are played back in fast motion at 2 \times faster speed.



Open with HS Footage

Enter shooting mode → MENU button →  menu icon → Open with HS footage →  button



Set whether to start recording at high speed or normal speed when recording HS movies.

Option	Description
On (default setting)	Record HS movies when movie recording begins.
Off	Record normal speed movies when movie recording begins.

Autofocus Mode



Enter shooting mode → MENU button →  menu icon → Autofocus mode →  button

Set how the camera focuses in movie mode.

Option	Description
AF-S Single AF (default setting)	Focus is locked when the  (●  movie-record) button is pressed to start recording. Select this option when the distance between the camera and the subject will remain fairly consistent.
AF-F Full-time AF	Camera focuses continuously. Select this option when the distance between the camera and subject will change significantly during recording. The sound of the camera focusing may be heard in the recorded movie. Use of Single AF is recommended to prevent the sound of the camera focusing from interfering with recording.

- When an HS movie option is selected in **Movie options**, the setting is fixed at **Single AF**.

Wind Noise Reduction

Enter shooting mode → MENU button →  menu icon → Wind noise reduction →  button

Set whether or not to reduce wind noise during movie recording.

Option	Description
 On	Reduces the sound produced when wind passes over the microphone. Other sounds may become difficult to hear during playback.
Off (default setting)	Wind noise reduction is not enabled.



- When an HS movie option is selected in **Movie options**, the setting is fixed at **Off**.

The Setup Menu



Welcome Screen

Press the MENU button →  menu icon → Welcome screen →  button







Configure the welcome screen that is displayed when you turn on the camera.

Option	Description
None (default setting)	Does not display the welcome screen.
COOLPIX	Displays a welcome screen with the COOLPIX logo.
Select an image	<p>Displays an image selected for the welcome screen.</p> <ul style="list-style-type: none">• The image selection screen is displayed. Select an image (58) and press the  button.• Because a copy of the selected image is saved in the camera, it will be displayed when the camera is turned on, even if the original image is deleted.• An image cannot be selected if its aspect ratio is different from that of the screen, or if the image size is extremely small after the small picture or crop function is applied.

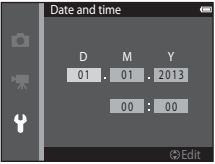

Time Zone and Date

Press the MENU button →  menu icon → Time zone and date →  button

Set the camera clock.

Option	Description
Date and time	<ul style="list-style-type: none">• Select an item: Press the multi selector  (changes between D, M, Y, hour, and minute).• Edit the date and time: Press  .• Apply the setting: Select the minute setting and press the  button. 
Date format	Select Year/Month/Day , Month/Day/Year , or Day/Month/Year .
Time zone	<p>Set time zone and daylight saving time.</p> <ul style="list-style-type: none">• When Travel destination () is set after having set the home time zone () , the time difference between the travel destination and the home time zone is automatically calculated, and the date and time are saved for the selected region.

Setting the Time Zone

- 1 Use the multi selector   to select **Time zone** and press the  button.

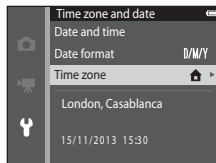

2 Select **Home time zone** or **Travel destination** and press the button.



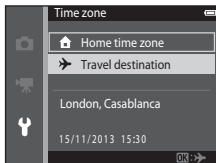

- The date and time displayed in the monitor changes depending on whether the home time zone or travel destination is selected.

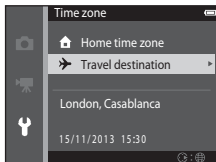

3 Press .



4 Use to select the time zone.

- Press  to enable daylight saving time function, and  is displayed. Press  to disable the daylight saving time function.
- Press the  button to apply the time zone.
- If the correct time is not displayed for the home or travel destination time zone setting, set the appropriate time in **Date and time**.

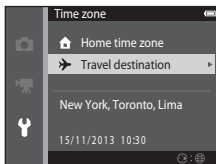
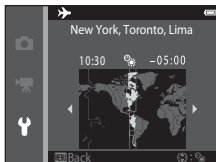









Monitor Settings

Press the **MENU** button → **Y** menu icon → Monitor settings → **OK** button

Option	Description
Photo info	Set whether or not to display information in the monitor.
Image review	This setting determines whether or not the captured image is displayed immediately after shooting. <ul style="list-style-type: none">• Default setting: On
Brightness	Select from five settings. <ul style="list-style-type: none">• Default setting: 3

Photo Info

	Shooting mode	Playback mode
Show info	 The monitor displays a woman in the foreground and a sailboat on the water. Various camera settings are overlaid on the image, including a battery level indicator, a signal strength icon, a zoom level indicator, a white balance icon, a focus mode icon, a shutter speed of 1/250, an aperture of f/2.8, and a battery level of 83%.	 The monitor displays the same scene as the shooting mode. The photo info overlay includes a battery level of 47%, a signal strength icon, a zoom level indicator, a white balance icon, a focus mode icon, a shutter speed of 1/250, an aperture of f/2.8, and a battery level of 83%.
Auto info (default setting)	Current settings and operation guide are displayed as in Show info . If no operations are performed for a few seconds, the information is hidden as in Hide info . Information is displayed again when the next operation is performed.	
Hide info	 The monitor displays the same scene as the shooting mode, but with no photo info overlay.	 The monitor displays the same scene as the playback mode, but with no photo info overlay.

	Shooting mode	Playback mode
Framing grid+auto info	 <p>In addition to information shown with Auto info, a framing grid is displayed to help frame images. The framing grid is not displayed when recording movies.</p>	 <p>The current settings or operation guide is displayed as in Auto info.</p>
Movie frame+auto info	 <p>In addition to information shown with Auto info, a frame is displayed before recording begins that represents the area that will be captured when recording movies. The movie frame is not displayed when recording movies.</p>	 <p>The current settings or operation guide is displayed as in Auto info.</p>

Notes About Monitor Settings

When **Quick effects** () is set to **On**, **Image review** is fixed at **On**.

Print Date (Imprinting Date and Time)

Press the **MENU** button → **Y** menu icon → **Print date** → **OK** button

The shooting date and time can be imprinted on the images when shooting, allowing the information to be printed even from printers that do not support date printing (📷55).



Option	Description
DATE Date	Date is imprinted on images.
DATE 📷 Date and time	Date and time are imprinted on images.
Off (default setting)	Date and time are not imprinted on images.

✔ Notes About Print Date

- Imprinted dates form a permanent part of image data and cannot be deleted. The date and time cannot be imprinted on images after they have been captured.
- The date and time cannot be imprinted in the following situations:
 - When using **Night portrait** (when **Hand-held** is selected), **Night landscape** (when **Hand-held** is selected), or **Easy panorama** scene mode
 - When the continuous shooting setting (📷39) is set to **Pre-shooting cache**, **Continuous H: 120 fps**, or **Continuous H: 60 fps**
 - When shooting movies
- The imprinted date and time may be difficult to read when using a small image size.

Gesture Control

Press the **MENU** button →  menu icon → **Gesture control** →  button









Set whether or not to enable the gesture control function when you position the monitor facing forward in the same direction as the camera lens.

This function is available in **Portrait** and **Night portrait** scene modes, smart portrait mode, and  (auto) mode.

Option	Description
 On (default setting)	Gesture control is enabled.
Off	Gesture control is disabled.

Notes About Gesture Control

- The camera may not detect your palm or hand movement in some shooting conditions.
- When moving your hand, hold up your palm vertically facing the camera, and maintain the same hand shape as you move it.
- The functions listed below cannot be used when the gesture control function is in use.

Restricted function	Description
Self-timer ()51), Quick effects ()48), Smile timer ()50), AF assist ()79), Digital zoom ()79)	This function cannot be used.
Continuous ()39)	The setting is fixed at Single if Continuous H , Continuous L , Pre-shooting cache , or BSS is set before you start using the gesture control function.
AF area mode ()44)	The setting is fixed at Target finding AF .
Monitor settings ()73)	Photo info is fixed at Show info .
Auto off ()80)	The setting is fixed at 5 min if 30 s or 1 min is set before you start using the gesture control function.

- When the monitor is returned to the open rearward-facing position against the back of the camera, the restricted functions are reset to their original settings (if you did not change the settings while using the gesture control function).

Vibration Reduction

Press the MENU button →  menu icon → Vibration reduction →  button

Set to reduce the effects of camera shake while shooting.

Set **Vibration reduction** to **Off** when using a tripod to stabilize the camera during shooting.

Option	Description
 On (default setting)	Vibration reduction is enabled.
Off	Vibration reduction is disabled.





Notes About Vibration Reduction

- After turning on the camera or after switching from playback mode to shooting mode, wait for the shooting mode screen to be displayed completely before taking images.
- Images displayed in the camera monitor immediately after shooting may be displayed blurry.
- Vibration reduction may be unable to completely eliminate the effects of camera shake in some situations.

Motion Detection

Press the **MENU** button →  menu icon → Motion detection →  button

Enable motion detection to reduce the effects of subject movement and camera shake when shooting still images.

Option	Description
 Auto (default setting)	Motion detection is enabled with some shooting modes or settings, when  is displayed on the shooting screen. When the camera detects subject movement or camera shake,  turns green, and the ISO sensitivity and shutter speed are automatically increased to reduce blurring. <ul style="list-style-type: none">• Set ISO sensitivity (42) to Auto in  (auto) mode.
Off	Motion detection is disabled.

Notes About Motion Detection

- Motion detection may be unable to eliminate the effects of subject movement and camera shake in some situations.
- Motion detection may be disabled if the subject exhibits significant movement or is too dark.
- The images captured using motion detection may be somewhat “grainy” in appearance.



AF Assist

Press the MENU button →  menu icon → AF assist →  button

Enable or disable the AF-assist illuminator which assists autofocus operation.

Option	Description
AUTO Auto (default setting)	The AF-assist illuminator automatically lights up when the subject is dimly lit. The illuminator has a range of about 2.0 m (6 ft 6 in.) at the maximum wide-angle position and about 1.1 m (3 ft 7 in.) at the maximum telephoto position. <ul style="list-style-type: none">Note that for some scene modes or focus areas, the AF-assist illuminator may not light.
Off	The AF-assist illuminator does not light.





Digital Zoom

Press the MENU button →  menu icon → Digital zoom →  button

Option	Description
On (default setting)	Digital zoom is enabled.
Off	Digital zoom is disabled.

Notes About Digital Zoom

Digital zoom cannot be used in the following situations.



- When **Portrait, Night portrait, Night landscape, Backlighting** (when HDR is set to **On**), **Easy panorama**, or **Pet portrait** is selected in scene mode
- When smart portrait mode is selected
- When **Continuous** () is set to **Multi-shot 16** in  (auto) mode
- When **AF area mode** () is set to **Subject tracking** in  (auto) mode

Sound Settings

Press the MENU button →  menu icon → Sound settings →  button

Option	Description
Button sound	<p>When On (default setting) is selected, the camera produces one beep when operations are performed, two beeps when focus is acquired on the subject, and three beeps when an error occurs. The start-up sound is also produced.</p> <ul style="list-style-type: none">• Sounds are disabled when using Pet portrait scene mode.
Shutter sound	<p>When On (default setting) is selected, the shutter sound is produced when the shutter is released.</p> <ul style="list-style-type: none">• The shutter sound is not produced when using continuous shooting mode, when recording movies, or when using Pet portrait scene mode.

Auto Off

Press the MENU button →  menu icon → Auto off →  button

Set the amount of time that elapses before the camera enters standby mode (21). You can select **30 s**, **1 min** (default setting), **5 min**, or **30 min**.

Notes About Auto Off

The time that passes before the camera enters standby mode is fixed in the following situations:

- When a menu is displayed: 3 minutes (5 or 30 minutes if **5 min** or **30 min** is selected)
- When the AC adapter EH-62G is connected: 30 minutes
- When an audio video cable or HDMI cable is connected: 30 minutes

Format Memory/Format Card

Press the MENU button →  menu icon → Format memory/Format card →  button

Use this option to format the internal memory or a memory card.

Formatting the internal memory or memory cards permanently deletes all data. Data that has been deleted cannot be recovered. Make sure to transfer important images to a computer before formatting.

- Do not turn the camera off or open the battery-chamber/memory card slot cover during formatting.

Formatting the Internal Memory

Remove the memory card from the camera. The **Format memory** option is displayed in the setup menu.

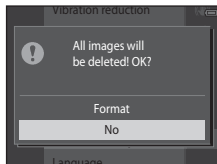

Formatting Memory Cards

Insert a memory card in the camera. The **Format card** option is displayed in the setup menu.

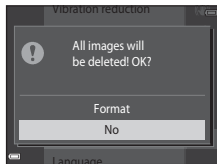

Language

Press the **MENU** button → **Y** menu icon → Language → **OK** button

Select a language for display of camera menus and messages.

TV Settings

Press the **MENU** button → **Y** menu icon → TV settings → **OK** button



Adjust settings for connection to a TV.

Option	Description
Video mode	Select from NTSC and PAL . Both NTSC and PAL are standards for analog color television broadcasting. <ul style="list-style-type: none">The available frame rates in Movie options (60/64) vary depending on the video mode setting.
HDMI	Select a resolution for HDMI output. When Auto (default setting) is selected, the option best suited to the TV to which the camera is connected is automatically selected from 480p , 720p , or 1080i .
HDMI device control	When On (default setting) is selected, the HDMI-CEC-compatible TV's remote control can be used to control the camera during playback (23).

HDMI and HDMI-CEC

HDMI (High-Definition Multimedia Interface) is a multimedia interface. HDMI-CEC (HDMI-Consumer Electronics Control) allows compatible devices to inter-operate.

Charge by Computer

Press the MENU button →  menu icon → Charge by computer →  button

Option	Description
AUTO Auto (default setting)	When the camera is connected to a computer that is running (📖83), the battery inserted into the camera is automatically charged using power supplied by the computer.
Off	The battery inserted into the camera is not charged when the camera is connected to a computer.

Notes About Charging with a Computer

- When connected to a computer, the camera automatically turns on and starts charging. If the camera is turned off, charging stops.
- About 3 hours and 15 minutes are required to charge a fully exhausted battery. Charging time increases when images are transferred while the battery is charging.
- The camera turns off automatically if there is no communication with the computer for 30 minutes after the battery has finished charging.

When the Charge Lamp Quickly Flashes Green

Charging cannot be performed, possibly due to one of the reasons described below.

- The ambient temperature is not suited to charging. Charge the battery indoors with an ambient temperature of 5°C to 35°C (41°F to 95°F).
- The USB cable is not connected correctly, or the battery is faulty. Make sure the USB cable is connected correctly and replace the battery if necessary.
- The computer is in sleep mode and is not supplying power. Wake up the computer.
- The battery cannot be charged because the computer cannot supply power to the camera due to the computer's settings or its specifications.

Blink Warning

Press the **MENU** button → **Y** menu icon → **Blink warning** → **OK** button

Select whether or not the camera detects human subjects that have blinked using face detection (📖64) when shooting in the following modes:

- **SR** (scene auto selector) mode (📖32)
- **Portrait** or **Night portrait** scene mode (📖34)
- **📷** (auto) mode (when **Face priority** (🔗44) is selected for AF area mode option)

Option	Description
On	When one or more human subjects may have blinked in an image captured using face detection, the Did someone blink? screen is displayed in the monitor. Check the image and determine whether or not another image should be captured.
Off (default setting)	Blink warning is disabled.

The Blink Warning Screen

Faces detected by the blink warning are displayed inside a border.

The operations described below are available.

- To enlarge the face: Move the zoom control toward **T** (🔍). If more than one face is detected, use the multi selector (◀▶) to select the desired face.
- To switch to full-frame playback: Move the zoom control toward **W** (📷).





If you press the **OK** button, or if no operations are performed for a few seconds, the camera returns to shooting mode.

✓ Notes About Blink Warning

- The blink warning is disabled at continuous settings other than **Single** (🔗39).
- The blink warning may not function properly in some shooting conditions.

Wi-Fi Options

Press the **MENU** button →  menu icon → Wi-Fi options →  button

Configure the Wi-Fi (wireless LAN) settings to connect the camera and a smart device.

Option	Description
Wi-Fi network	When wirelessly connecting the camera and a smart device, set Wi-Fi network to On . The default setting is Off . See "Using the Wi-Fi (Wireless LAN) Function" (📖80) for more information.
SSID	Change the SSID. The SSID configured here is displayed on the smart device. Set a 1- to 24-character alphanumeric SSID.
Auth./encryp.	Select whether or not to encrypt the communications between the camera and the connected smart device. Communications are not encrypted when Open (default setting) is selected.
Password	Set the password. Set a 8- to 16-character alphanumeric password.
Channel	Select the channel used for wireless connections.
Current settings	Display the current settings.
Restore factory defaults	Restore the Wi-Fi settings to their default values.

Operating the Text Input Keyboard

- Use the multi selector ▲▼◀▶ to select alphanumeric characters. Press the **OK** button to enter the selected character in the text field and move the cursor to the next space.
- To move the cursor in the text field, select ← or → on the keyboard, and press the **OK** button.
- To delete one character, press the **⌫** button.
- To apply the setting, select ↩ on the keyboard and press the **OK** button.

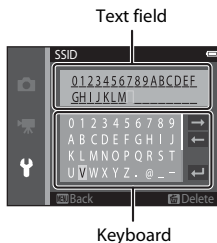



✓ Notes About Wi-Fi Network

Wi-Fi network cannot be selected in the following situations:

- When an HDMI, USB or audio/video cable is connected to the camera
- When no memory card is inserted in the camera
- When an Eye-Fi card is inserted in the camera
- When the battery level indicator in the monitor indicates 

Eye-Fi Upload

Press the **MENU** button →  menu icon → Eye-Fi upload →  button





Option	Description
 Enable (default setting)	Upload images created by the camera to a preselected destination.
 Disable	Images are not uploaded.

Notes About Eye-Fi Cards



- Note that images will not be uploaded if signal strength is insufficient even if **Enable** is selected.
- Remove your Eye-Fi card from the camera where wireless devices are prohibited. Signals may be transmitted even if **Disable** is selected.
- Refer to the instruction manual of your Eye-Fi card for more information. In the event of malfunction, contact the card manufacturer.
- The camera can be used to turn Eye-Fi cards on and off, but may not support other Eye-Fi functions.
- The camera is not compatible with the Endless Memory function. When it is set on a computer, disable the function. If the Endless Memory function is enabled, the number of images taken may not be displayed correctly.
- Eye-Fi cards are for use only in the country of purchase. Observe all local laws concerning wireless devices.
- Leaving the setting as **Enable** will result in the battery being depleted in a shorter period of time.

Eye-Fi Communication Indicator

The communication status of the Eye-Fi card in the camera can be confirmed in the monitor (7).

- : **Eye-Fi upload** is set to **Disable**.
-  (lights): Eye-Fi upload enabled; waiting to begin upload.
-  (flashes): Eye-Fi upload enabled; uploading data.
- : Eye-Fi upload enabled but no images available for upload.
- : An error occurred. The camera cannot control the Eye-Fi card.

Reset All

Press the **MENU** button →  menu icon → **Reset all** →  button

When **Reset** is selected, the camera's settings are restored to their default values.

- Some settings, such as **Time zone and date** or **Language**, are not reset.



Resetting File Numbering

To reset file numbering to "0001", delete all images saved in the internal memory or on the memory card (30) before selecting **Reset all**.





Firmware Version







Press the **MENU** button →  menu icon → **Firmware version** →  button











View the current camera firmware version.





Error Messages









Refer to the table below if an error message is displayed.

Display	Cause/Solution	
Battery temperature is elevated. The camera will turn off. The camera will turn off to prevent overheating.	The camera turns off automatically. Wait until the camera or battery temperature has cooled before resuming use.	–
Memory card is write protected. This card cannot be used.	The write-protect switch is in the “lock” position. Slide the write-protect switch to the “write” position.	–
This card cannot be read.	An error occurred while accessing the memory card. <ul style="list-style-type: none">• Use an approved card.• Check that the terminals are clean.• Confirm that the memory card is correctly inserted.	14,  22
Card is not formatted. Format card?	The memory card has not been formatted for use in the camera. Formatting deletes all data saved on the memory card. If you need to keep copies of any images, make sure to select No and save the copies to a computer or other medium before formatting the memory card. Select Yes and press the  button to format the memory card.	 5

Display	Cause/Solution	
Not available if Eye-Fi card is locked.	The write-protect switch of the Eye-Fi card is in the "lock" position.	–
	An error occurred while accessing the Eye-Fi card. <ul style="list-style-type: none"> • Check that the terminals are clean. • Confirm that the Eye-Fi card is correctly inserted. 	14
Out of memory.	Delete images or insert a new memory card.	14, 30, 77
Image cannot be saved.	An error occurred while saving the image. Insert a new memory card or format the internal memory or memory card.	 81
	The camera has run out of file numbers. Insert a new memory card or format the internal memory or memory card.	 81
	The image cannot be used for the welcome screen.	 70
	There is insufficient space to save the copy. Delete images from the destination.	30
Album is full. No further pictures can be added.	200 images have already been added to the album. <ul style="list-style-type: none"> • Remove some images from the album. • Add to other albums. 	 8  6
Sound file cannot be saved.	A voice memo cannot be attached to this image. <ul style="list-style-type: none"> • Voice memos cannot be attached to movies. • Select an image captured with this camera. 	–

Display	Cause/Solution	
Image cannot be modified.	Select images that support the editing function.	 14,  14
Cannot record movie.	A time-out error occurred while saving the movie on the memory card. Select a memory card with a faster write speed.	73,  22
Memory contains no images.	There are no images in the internal memory or on the memory card. <ul style="list-style-type: none"> Remove the memory card from the camera to play back images in the camera's internal memory. To copy the images saved in the camera's internal memory to the memory card, press the MENU button to select Copy in the playback menu. 	15  61
	No images have been added to the selected album.	 6,  7
	No images are contained in the category selected in auto sort mode.	 10
File contains no image data.	The file was not created or edited with this camera. The file cannot be viewed on this camera.	-
This file cannot be played back.	View the file using a computer or the device used to create or edit this file.	-
All images are hidden.	There are no images available for a slide show, etc.	 56
This image cannot be deleted.	The image is protected. Disable protection.	 57

Display	Cause/Solution	
No access.	The camera could not receive the communication signal from the smart device. Set Wi-Fi network to On in Wi-Fi options in the setup menu, and wirelessly connect the camera and smart device again.	81,  85
Could not connect.	The camera failed to establish the connection while receiving the communication signals from the smart device. Select a different channel in Channel in Wi-Fi options in the setup menu and establish the wireless connection again.	81,  85
Wi-Fi connection terminated.	A cable was connected to the camera while the camera and smart device were wirelessly connected, the battery level became low, or the connection was aborted due to poor connectivity. Disconnect the cable and establish the wireless connection again.	81,  85
Lens error	A lens error occurred. Turn the camera off and then on again. If the error persists, contact your retailer or Nikon-authorized service representative.	20
Communications error	An error occurred while communicating with the printer. Turn the camera off and reconnect the USB cable.	 25
System error	An error occurred in the camera's internal circuitry. Turn the camera off, remove and reinsert the battery, and turn the camera on. If the error persists, contact your retailer or Nikon-authorized service representative.	10, 20

Display	Cause/Solution	
Printer error: check printer status.	After solving the problem, select Resume and press the  button to resume printing.*	–
Printer error: check paper.	Load the specified size of paper, select Resume , and press the  button to resume printing.*	–
Printer error: paper jam.	Remove the jammed paper, select Resume , and press the  button to resume printing.*	–
Printer error: out of paper.	Load the specified size of paper, select Resume , and press the  button to resume printing.*	–
Printer error: check ink.	There is a problem with the printer's ink. Check the ink, select Resume , and press the  button to resume printing.*	–
Printer error: out of ink.	Replace the ink cartridge, select Resume , and press the  button to resume printing.*	–
Printer error: file corrupt.	There is a problem with the image file to be printed. Select Cancel and press the  button to cancel printing.	–

* See the documentation provided with your printer for further guidance and information.

File Names

Images, movies, or voice memos are assigned file names as follows.

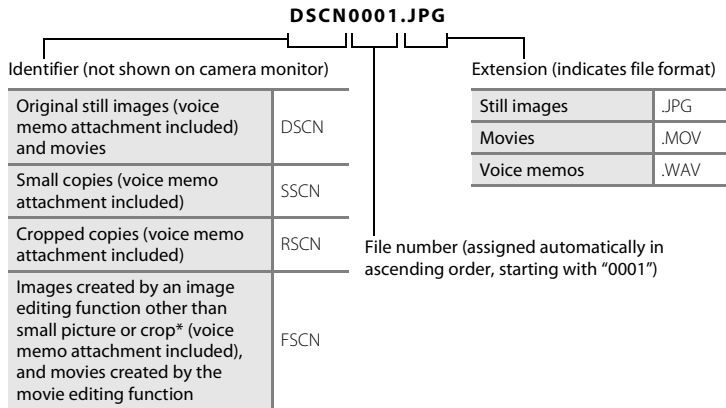

* Including images edited using the quick effects function (📖45) in 📷 (auto) mode

- Voice memo file names have the same identifier and file number as the image to which the voice memo is attached.

Optional Accessories

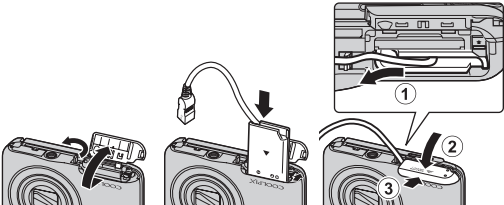
Battery charger	Battery Charger MH-66 (Charging time when no charge remains: Approx. 1 h 50 min)
AC adapter	<p data-bbox="327 189 664 210">AC Adapter EH-62G (connect as shown)</p>  <p data-bbox="327 469 928 585">Make sure that the power connector cord has been properly aligned in power connector and battery chamber grooves before closing the battery-chamber/memory card slot cover. If part of the cord runs out of the grooves, the cover or cord may be damaged when the cover is closed.</p>
Audio/video cable	Audio Video Cable EG-CP16

Availability may vary with country or region.
See our website or brochures for the latest information.



A series of ten horizontal dashed lines spanning the width of the page, intended for handwriting practice.



Technical Notes and Index

Caring for the Product	2
The Camera.....	2
The Battery.....	3
Charging AC Adapter.....	4
Memory Cards.....	5
Cleaning and Storage	6
Cleaning.....	6
Storage.....	6
Troubleshooting	7
Specifications	17
Approved Memory Cards.....	22
Index	25

Caring for the Product

The Camera

To ensure continued enjoyment of this Nikon product, observe the precautions described below in addition to the warnings in “For Your Safety” (📖viii-x) when using or storing the device.

✔ **Do Not Drop**

The product may malfunction if subjected to strong shock or vibration.

✔ **Handle the Lens and All Moving Parts with Care**

Do not apply force to the lens, lens cover, monitor, memory card slot, or battery chamber. These parts are easily damaged. Applying force to the lens cover could result in camera malfunction or damage to the lens. Should the monitor break, care should be taken to avoid injury caused by broken glass and to prevent the liquid crystal from the display touching the skin or entering the eyes or mouth.

✔ **Keep Dry**

The device will be damaged if immersed in water or subjected to high humidity.

✔ **Avoid Sudden Changes in Temperature**

Sudden changes in temperature, such as when entering or leaving a heated building on a cold day, can cause condensation to form inside the device. To prevent condensation, place the device in a carrying case or a plastic bag before exposing it to sudden changes in temperature.

✔ **Keep away from Strong Magnetic Fields**

Do not use or store this device in the vicinity of equipment that generates strong electromagnetic radiation or magnetic fields. Strong static charge or the magnetic fields produced by equipment such as radio transmitters could interfere with the monitor, damage data saved on the memory card, or affect the product's internal circuitry.

Do Not Point the Lens at Strong Light Sources for Extended Periods

Avoid pointing the lens at the sun or other strong light sources for extended periods when using or storing the camera. Intense light may cause deterioration of the image sensor, producing a white blur effect in photographs.

Turn the Product off Before Removing or Disconnecting the Power Source

Do not remove the battery while the product is on, or while images are being saved or deleted. Forcibly cutting power in these circumstances could result in loss of data or in damage to product memory or internal circuitry.

Notes About the Monitor

- Monitors and electronic viewfinders are constructed with extremely high precision; at least 99.99% of pixels are effective, with no more than 0.01% being missing or defective. Hence while these displays may contain pixels that are always lit (white, red, blue, or green) or always off (black), this is not a malfunction and has no effect on images recorded with the device.
- Images in the monitor may be difficult to see under bright lighting.
- The monitor is lit by an LED backlight. Should the monitor begin to dim or flicker, contact your Nikon-authorized service representative.

The Battery

Be sure to read and follow the warnings in “For Your Safety” (📖viii-x) before use.

- Check the battery level before using the camera and replace or charge the battery if necessary. Do not continue charging once the battery is fully charged as this will result in reduced battery performance. Whenever possible, carry a fully charged spare battery when taking images on important occasions.
- Do not use the battery at ambient temperatures below 0°C (32°F) or above 40°C (104°F).
- Charge the battery indoors with an ambient temperature of 5°C to 35°C (41°F to 95°F) before use.
- When charging the battery inserted into this camera using the Charging AC Adapter or a computer, the battery is not charged at battery temperatures below 0°C (32°F) or above 45°C (113°F).

- Note that the battery may become hot during use; wait for the battery to cool before charging. Failure to observe these precautions could damage the battery, impair its performance, or prevent it from charging normally.
- On cold days, the capacity of batteries tends to decrease. If an exhausted battery is used at a low temperature, the camera will not turn on. Be sure that the battery is fully charged before heading outside to take images in cold weather. Keep spare batteries in a warm place and exchange as necessary. Once warmed, a cold battery may recover some of its charge.
- Dirt on the battery terminals can prevent the camera from functioning. Should the battery terminals become dirty, wipe them off with a clean, dry cloth before use.
- If the battery will not be used for some time, insert it in the camera and completely exhaust it before removing it for storage. The battery should be stored in a cool location with an ambient temperature of 15°C to 25°C (59°F to 77°F). Do not store the battery in hot or extremely cold locations.
- Always remove the battery from the camera or optional battery charger when it is not being used. When inserted, minute amounts of current are drawn from the battery even when not in use. This may result in excessive draining of the battery and complete loss of function. Turning the camera on or off while the battery is exhausted can result in reduced battery life.
- Recharge the battery at least once every six months and completely exhaust it before returning it to storage.
- After removing the battery from the camera or optional battery charger, put the battery in the included battery case and store it in a cool place.
- A marked drop in the time a fully-charged battery retains its charge, when used at room temperature, indicates that the battery needs to be replaced. Purchase a new EN-EL19 battery.
- Replace the battery when it no longer holds a charge. Used batteries are a valuable resource. Please recycle used batteries in accordance with local regulations.

Charging AC Adapter

Be sure to read and follow the warnings in “For Your Safety” (□□viii-x) before use.

- The Charging AC Adapter EH-70P is for use only with compatible devices. Do not use with another make or model of device.
- The EH-70P is compatible with AC 100-240 V, 50/60 Hz electrical outlets. When using in other countries, use a plug adapter (commercially available) as necessary. For more information about plug adapters, consult your travel agency.

- Do not, under any circumstances, use another make or model of AC adapter other than Charging AC Adapter EH-70P or USB-AC adapter. Failure to observe this precaution could result in overheating or in damage to the camera.

Memory Cards

- Use only Secure Digital memory cards. See “Approved Memory Cards” (🔍-22) for recommended memory cards.
- Observe the precautions noted in the documentation included with your memory card.
- Do not affix labels or stickers to the memory card.
- Do not format the memory card using a computer.
- The first time you insert a memory card that has been used in another device into this camera, be sure to format it with this camera. We recommend formatting new memory cards with this camera before using them with this camera.
- Note that **formatting a memory card permanently deletes all images and other data on the memory card**. If there is data saved on the memory card that you wish to keep, copy that data to a computer before formatting.
- If the message **Card is not formatted. Format card?** is displayed when the camera is turned on, the memory card must be formatted. If there is data on the memory card that you do not want to delete, select **No** and press the **ⓧ** button. Copy that data to a computer before formatting. To format the memory card, select **Yes**.
- Observe the following precautions while formatting the memory card, saving and deleting images, and copying images to a computer, otherwise data or the memory card itself may be damaged.
 - Do not open the battery-chamber/memory card slot cover or remove the memory card or battery.
 - Do not turn off the camera.
 - Do not disconnect the AC adapter.

Cleaning and Storage

Cleaning

Do not use alcohol, thinner, or other volatile chemicals.

Lens	Avoid touching glass parts with your fingers. Remove dust or lint with a blower (typically a small device with a rubber bulb attached to one end that is pumped to produce a stream of air out the other end). To remove fingerprints or other stains that cannot be removed with a blower, wipe the lens with a soft cloth, using a spiral motion that starts at the center of them and working toward the edges. If this fails, clean the lens using a cloth lightly dampened with commercial lens cleaner.
Monitor	Remove dust or lint with a blower. To remove fingerprints and other stains, clean the monitor with a soft, dry cloth, being careful not to apply pressure.
Body	Use a blower to remove dust, dirt, or sand, then wipe gently with a soft, dry cloth. After using the camera at the beach or other sandy or dusty environment, wipe off any sand, dust, or salt with a dry cloth lightly dampened with fresh water and dry thoroughly. Note that foreign matter inside the camera could cause damage not covered by the warranty.

Storage

Turn the camera off when not in use. Be sure that the power-on lamp is off before putting the camera away. Remove the battery if the camera will not be used for an extended period. Do not store the camera with naphtha or camphor moth balls, or in any of the following locations:

- Next to equipment that produces strong electromagnetic fields, such as televisions or radios
- Exposed to temperatures below -10°C (14°F) or above 50°C (122°F)
- Places that are poorly ventilated or subject to humidity of over 60%



To prevent mold or mildew, take the camera out of storage at least once a month. Turn the camera on and release the shutter a few times before putting the camera away again.











For storing the battery, follow the precautions in “The Battery” (🔋:3) in “Caring for the Product” (🔧:2).





Troubleshooting

If the camera fails to function as expected, check the list of common problems below before consulting your retailer or Nikon-authorized service representative.







Power, Display, Settings Issues









Problem	Cause/Solution	
The camera is on but does not respond.	Wait for recording to end. If the problem persists, turn the camera off. If the camera does not turn off, remove and reinsert the battery or batteries or, if you are using an AC adapter, disconnect and reconnect the AC adapter. Note that although any data currently being recorded will be lost, data that have already been recorded will not be affected by removing or disconnecting the power source.	20,  95
Battery inserted in the camera cannot be charged.	<ul style="list-style-type: none">• Confirm all connections.• When connected to a computer, the camera may not charge for any of the reasons described below.<ul style="list-style-type: none">- Off is selected for Charge by computer in the setup menu.- Battery charging stops if the camera is turned off.- Battery charging is not possible if the camera's display language and date and time have not been set, or the date and time were reset after the camera's clock battery was exhausted. Use the Charging AC Adapter to charge the battery.- Battery charging may stop if the computer is in sleep mode.- Depending upon the computer specifications, settings, and status, battery charging may not be possible.	12 79,  83 – 16, 18 – –
Camera cannot be turned on.	The battery is exhausted.	20













Problem	Cause/Solution	
Camera turns off without warning.	<ul style="list-style-type: none"> The camera automatically turns off to save power (auto off function). The camera or battery have become too cold and cannot operate properly. The inside of the camera has become hot. Leave the camera off until the inside of the camera has cooled, and then try turning it on again. The camera turns off if the USB cable connecting it to a computer or printer is disconnected. Reconnect the USB cable. 	21  3 – 83, 88,  25
Monitor is blank.	<ul style="list-style-type: none"> The camera is off. The camera has entered standby mode to save power. Press the power switch, shutter-release button,  button,  button, or  (movie-record) button. The flash lamp flashes while the flash is charging. Wait for the flash to charge. The camera and computer are connected via the USB cable. The camera and TV are connected via an audio/video cable or HDMI cable. 	20 1, 21 49 83, 88 83,  22
Monitor is hard to read.	<ul style="list-style-type: none"> Adjust the monitor brightness. The monitor is dirty. Clean the monitor. 	78,  73  6
Date and time of recording are not correct.	<ul style="list-style-type: none"> If the camera clock has not been set, the “Date not set” indicator flashes during shooting and movie recording. Images and movies saved before the clock is set are dated “00/00/0000 00:00” or “01/01/2013 00:00” respectively. Set the correct time and date from the Time zone and date option in the setup menu. The camera clock is not as accurate as ordinary watches or clocks. Periodically compare the time of the camera clock with that of a more accurate timepiece and reset as required. 	16, 78,  71





Problem	Cause/Solution	
No indicators displayed in monitor.	Hide info is selected for Photo info in Monitor settings in the setup menu.	78,  73
Print date not available.	Time zone and date has not been set in the setup menu.	16, 78,  71
Date not imprinted on images even when Print date is enabled.	<ul style="list-style-type: none"> • The current shooting mode does not support Print date. • The date cannot be imprinted on movies. 	78,  75
Screen for setting time zone and date is displayed when camera is turned on.	The clock battery is exhausted; all settings were restored to their default values.	16, 18
Camera settings reset.		
Monitor turns off, and the power-on lamp flashes quickly.	The battery temperature is high. Turn off the camera and allow the battery to cool down before resuming use. After the lamp flashes for three minutes, the camera turns off automatically. Pressing the power switch also turns off the camera.	–
Camera becomes hot.	The camera may become hot when used for an extended period of time to shoot movies or send images using an Eye-Fi card, or when used in a hot environment; this is not a malfunction.	–
Camera makes sound.	When Autofocus mode is set to Full-time AF or while in some shooting modes, the camera may produce an audible focusing sound.	58, 75

Shooting Issues





Problem	Cause/Solution	
Cannot switch to shooting mode.	<ul style="list-style-type: none">• Disconnect the HDMI cable or USB cable.• The camera cannot be switched to shooting mode while connected to a power outlet via the Charging AC Adapter.	83, 88,  22,  25 12
No image captured when the shutter-release button is pressed.	<ul style="list-style-type: none">• When the camera is in playback mode, press the  button, the shutter-release button, or the  (movie-record) button.• When menus are displayed, press the MENU button.• The battery is exhausted.• When the flash lamp is flashing, the flash is charging.	1, 28 4 20 49
Camera cannot focus.	<ul style="list-style-type: none">• The subject is too close. Try shooting using scene auto selector mode, Close-up scene mode, or macro mode.• The subject is hard to focus on.• Set AF assist in the setup menu to Auto.• Turn the camera off and then on again.	32, 36, 53 66 79,  79 20
Images are blurred.	<ul style="list-style-type: none">• Use the flash.• Increase the ISO sensitivity value.• Enable vibration reduction or motion detection.• Use BSS (Best Shot Selector).• Use a tripod to stabilize the camera when shooting (using the self-timer at the same time is more effective).	49 58 78 37, 58,  39 51





Problem	Cause/Solution	
Bright specks appear in images captured with flash.	The flash is reflecting off particles in the air. Set the flash mode setting to  (off).	50
Flash does not fire.	<ul style="list-style-type: none"> • The flash mode is set to  (off). • A scene mode that restricts the flash is selected. • On is selected for Blink proof in the smart portrait menu. • On (continuous) or On (BSS) is selected for Smile timer in the smart portrait menu. • A function that restricts the flash is enabled. 	49 55 59 59 60
Digital zoom cannot be used.	<ul style="list-style-type: none"> • Digital zoom is set to Off in the setup menu. • Digital zoom cannot be used in the following situations. <ul style="list-style-type: none"> - When Portrait, Night portrait, Night landscape, Backlighting (when HDR is set to On), Easy panorama, or Pet portrait is selected in scene mode - When smart portrait mode is selected - When Continuous in the shooting menu is set to Multi-shot 16 - When AF area mode in the shooting menu is set to Subject tracking • The gesture control function is in use. 	79,  79 34 42 58,  39 58,  44 46,  76
Image mode not available.	A function that restricts the Image mode option is enabled.	60
No sound when shutter is released.	Off is selected for Sound settings > Shutter sound in the setup menu. No sound is produced with some shooting modes and settings, even when On is selected.	79,  80



Problem	Cause/Solution	
AF-assist illuminator does not light.	<ul style="list-style-type: none"> • Off is selected for the AF assist option in the setup menu. AF-assist illuminator may not light depending on the position of the focus area or the current scene mode, even when Auto is selected. • The gesture control function is in use. 	79,  79 46,  76
Images appear smeared.	The lens is dirty. Clean the lens.	 6
Colors are unnatural.	White balance or hue is not adjusted properly.	36, 58,  36
Randomly spaced bright pixels ("noise") appear in image.	<p>The subject is dark, and the shutter speed is too slow or ISO sensitivity is too high. Noise can be reduced by:</p> <ul style="list-style-type: none"> • Using the flash. • Specifying a lower ISO sensitivity setting. 	49 58,  42
Images are too dark (underexposed).	<ul style="list-style-type: none"> • The flash mode is set to  (off). • The flash window is blocked. • The subject is beyond the range of the flash. • Adjust exposure compensation. • Increase ISO sensitivity. • The subject is backlit. Select Backlighting scene mode or set the flash mode setting to  (fill flash). 	49 24 49 54 58,  42 37, 49
Images are too bright (overexposed).	Adjust exposure compensation.	54
Unexpected results when flash set to  (auto with red-eye reduction).	When taking images with  (auto with red-eye reduction), scene auto selector mode, or fill flash with slow sync and red-eye reduction in Night portrait scene mode, In-Camera Red Eye Fix may be applied to areas not affected by red-eye in rare cases. Use any scene mode other than Night portrait , and change the flash mode to any setting other than  (auto with red-eye reduction) and try taking an image again.	32, 35, 49

Problem	Cause/Solution	
Skin tones are not softened.	<ul style="list-style-type: none"> • In some shooting conditions, facial skin tones may not be softened. • For images containing four or more faces, try using the Skin softening effect in Glamour retouch in the playback menu. 	42 70,  18
Saving images takes time.	<p>It may take more time to save images in the following situations.</p> <ul style="list-style-type: none"> • When the noise reduction function is in operation, such as when shooting in a dark environment • When the flash mode is set to  (auto with red-eye reduction) • When shooting in Night landscape, Night portrait, or Backlighting (when HDR is set to On) scene mode • When the skin softening function is applied while shooting • When using continuous shooting mode 	– 50 35, 36, 37 59 58,  39
A ring-shaped belt or rainbow-colored stripe appears in the monitor or images.	When shooting with backlighting or when a very strong light source (such as sunlight) is in the frame, a ring-shaped belt or rainbow-colored stripe (ghosting) may occur. Change the position of the light source, or frame the image so that the light source does not enter the frame, and try again.	–

Playback Issues

Problem	Cause/Solution	
File cannot be played back.	<ul style="list-style-type: none"> • This camera may not be able to play back images saved with another make or model of digital camera. • This camera cannot play back movies recorded with another make or model of digital camera. • This camera may not be able to play back data edited on a computer. 	–
Cannot zoom in on image.	<ul style="list-style-type: none"> • Playback zoom cannot be used with movies, small pictures, or images that have been cropped to a size of 320 × 240 or smaller. • This camera may not be able to zoom in on images captured with another make or model of digital camera. 	–
Cannot record voice memos.	<ul style="list-style-type: none"> • Voice memos cannot be attached to movies. • Voice memos cannot be attached to images captured with other cameras. Voice memos attached to images using another camera cannot be played back on this camera. 	– 70,  60
Cannot edit image.	<ul style="list-style-type: none"> • Some images cannot be edited. Images that have already been edited may not be edited again. • There is not enough free space in the internal memory or on the memory card. • This camera is unable to edit images captured with other cameras. • Editing functions used for images are not available for movies. 	38,  14 – 70,  14 –

Problem	Cause/Solution	
Cannot rotate image.	This camera cannot rotate images captured with another make or model of digital camera.	–
Images are not displayed on TV.	<ul style="list-style-type: none"> • Video mode or HDMI is not correctly set in the TV settings setup menu. • The cables are connected to the HDMI micro connector (Type D) and to the USB/audio/video output connector simultaneously. • The memory card contains no images. Replace the memory card. Remove the memory card to play back images from the internal memory. 	79,  82 83, 88,  22,  25 15
Nikon Transfer 2 does not start when camera is connected to a computer.	<ul style="list-style-type: none"> • The camera is off. • The battery is exhausted. • The USB cable is not correctly connected. • The camera is not recognized by the computer. • Confirm system requirements. • The computer is not set to start Nikon Transfer 2 automatically. For more information about Nikon Transfer 2, refer to help information contained in ViewNX 2. 	20 20 83, 88 – 85 90
The PictBridge startup screen is not displayed when the camera is connected to a printer.	With some PictBridge-compatible printers, the PictBridge startup screen may not be displayed and it may be impossible to print images when Auto is selected for the Charge by computer option in the setup menu. Set the Charge by computer option to Off and reconnect the camera to the printer.	79,  83

Problem	Cause/Solution	
Images to be printed are not displayed.	<ul style="list-style-type: none"> • The memory card contains no images. Replace the memory card. • Remove the memory card to print images from the internal memory. 	14 15
Cannot select paper size with camera.	<p>The camera cannot be used to select the paper size in the following situations, even when printing from a PictBridge-compatible printer. Use the printer to select the paper size.</p> <ul style="list-style-type: none"> • The printer does not support the paper sizes specified by the camera. • The printer automatically selects the paper size. 	83,  28,  29 –

Specifications

Nikon COOLPIX S6600 Digital Camera

Type	Compact digital camera
Number of effective pixels	16.0 million
Image sensor	$\frac{1}{2.3}$ -in. type CMOS; approx. 16.79 million total pixels
Lens	NIKKOR lens with 12x optical zoom
Focal length	4.5-54.0 mm (angle of view equivalent to that of 25-300 mm lens in 35mm [135] format)
f/-number	f/3.3-6.3
Construction	9 elements in 7 groups (1 ED lens element)
Digital zoom magnification	Up to 4x (angle of view equivalent to that of approx. 1200 mm lens in 35mm [135] format)
Vibration reduction	Lens shift
Motion blur reduction	Motion detection (still pictures)
Autofocus (AF)	Contrast-detect AF
Focus range	<ul style="list-style-type: none">• [W]: Approx. 50 cm (1 ft 8 in.)–∞, [T]: Approx. 1.5 m (5 ft)–∞• Macro mode: Approx. 2 cm (0.8 in.)–∞ (wide-angle position) (All distances measured from center of front surface of lens)
Focus-area selection	Face priority, manual with 99 focus areas, center, subject tracking, target finding AF
Monitor	6.7 cm (2.7-in.), approx. 460k-dot, TFT LCD with anti-reflection coating and 5-level brightness adjustment
Frame coverage (shooting mode)	Approx. 97% horizontal and 97% vertical (compared to actual picture)
Frame coverage (playback mode)	Approx. 99% horizontal and 99% vertical (compared to actual picture)

Storage	
Media	Internal memory (approx. 25 MB), SD/SDHC/SDXC memory card
File system	DCF, Exif 2.3, and DPOF compliant
File formats	Still pictures: JPEG Sound files (Voice Memo): WAV Movies: MOV (Video: H.264/MPEG-4 AVC, Audio: LPCM stereo)
Image size (pixels)	<ul style="list-style-type: none"> • 16M (High) [4608 × 3456★] • 16M [4608 × 3456] • 8M [3264 × 2448] • 4M [2272 × 1704] • 2M [1600 × 1200] • VGA [640 × 480] • 16:9 [4608 × 2592] • 1:1 [3456 × 3456]
ISO sensitivity (Standard output sensitivity)	<ul style="list-style-type: none"> • ISO 125-1600 • ISO 3200, Hi 1 (equivalent to ISO 6400) (available when using Auto mode)
Exposure	
Metering mode	Matrix, center-weighted (digital zoom less than 2×), spot (digital zoom 2× or more)
Exposure control	Programmed auto exposure and exposure compensation (–2.0 – +2.0 EV in steps of $\frac{1}{3}$ EV)
Shutter	
Speed	<ul style="list-style-type: none"> • $\frac{1}{2000}$-1 s • $\frac{1}{4000}$ s (maximum speed during high-speed continuous shooting) • 4 s (Fireworks show scene mode)
Aperture	
Range	Electronically-controlled ND filter (–2 AV) selection 2 steps (f/3.3 and f/6.6 [W])
Self-timer	Can be selected from 10 s and 2 s

Flash	
Range (approx.) (ISO sensitivity: Auto)	[W]: 0.5–3.0 m (1 ft 8 in.–9 ft 10 in.) [T]: 1.5–1.8 m (5 ft–5 ft 10 in.)
Flash control	TTL auto flash with monitor preflashes
Interface	Hi-Speed USB
Data transfer protocol	MTP, PTP
Video output	Can be selected from NTSC and PAL
HDMI output	Can be selected from Auto, 480p, 720p, and 1080i
I/O terminal	Audio/video (A/V) output; digital I/O (USB) HDMI micro connector (Type D) (HDMI output)
Supported languages	Arabic, Bengali, Bulgarian, Chinese (Simplified and Traditional), Czech, Danish, Dutch, English, Finnish, French, German, Greek, Hindi, Hungarian, Indonesian, Italian, Japanese, Korean, Marathi, Norwegian, Persian, Polish, Portuguese (European and Brazilian), Romanian, Russian, Serbian, Spanish, Swedish, Tamil, Telugu, Thai, Turkish, Ukrainian, Vietnamese
Power sources	One Rechargeable Li-ion Battery EN-EL19 (included) AC Adapter EH-62G (available separately)
Charging time	Approx. 3 h (when using Charging AC Adapter EH-70P and when no charge remains)
Battery life¹	
Still pictures	Approx. 150 shots when using EN-EL19
Movies (actual battery life for recording) ²	Approx. 25 min when using EN-EL19
Tripod socket	1/4 (ISO 1222)
Dimensions (W × H × D)	Approx. 96.9 × 57.1 × 27.2 mm (3.9 × 2.3 × 1.1 in.) (excluding projections)
Weight	Approx. 165 g (5.9 oz) (including battery and SD memory card)

Operating environment	
Temperature	0°C–40°C (32°F–104°F)
Humidity	85% or less (no condensation)
Wi-Fi (Wireless LAN)	
Standards	IEEE 802.11b/g/n (standard wireless LAN protocol)
Communications protocols	IEEE 802.11b: DBPSK/DQPSK/CCK IEEE 802.11g: OFDM IEEE 802.11n: OFDM
Range (line of sight)	Approx. 10 m (11 yd)
Operating frequency	2412–2462 MHz (1–11 channels)
Data rates (actual measured values)	IEEE 802.11b: 5 Mbps IEEE 802.11g: 20 Mbps IEEE 802.11n: 20 Mbps
Security	WPA2
Access protocols	Infrastructure

- Unless otherwise stated, all figures assume a fully-charged battery and an ambient temperature of $23 \pm 3^{\circ}\text{C}$ ($73.4 \pm 5.4^{\circ}\text{F}$) as specified by the Camera and Imaging Products Association (CIPA).

- ¹ Battery life may vary depending on conditions of use, such as the interval between shots or the length of time that menus and images are displayed.
- ² Individual movie files cannot exceed 4 GB in size or 29 minutes in length. Recording may end before this limit is reached if camera temperature becomes elevated.

Rechargeable Li-ion Battery EN-EL19

Type	Rechargeable lithium-ion battery
Rated capacity	DC 3.7 V, 700 mAh
Operating temperature	0°C–40°C (32°F–104°F)
Dimensions (W × H × D)	Approx. 31.5 × 39.5 × 6 mm (1.3 × 1.6 × 0.3 in.)
Weight	Approx. 14.5 g (0.5 oz) (excluding battery case)

Charging AC Adapter EH-70P

Rated input	AC 100-240 V, 50/60 Hz, 0.07-0.044 A
Rated output	DC 5.0 V, 550 mA
Operating temperature	0°C–40°C (32°F–104°F)
Dimensions (W × H × D)	Approx. 55 × 22 × 54 mm (2.2 × 0.9 × 2.2 in.) (excluding plug adapter) For Argentina: Approx. 55 × 59 × 63 mm (2.2 × 2.4 × 2.5 in.) For Korea: Approx. 55 × 59 × 66.5 mm (2.2 × 2.4 × 2.7 in.)
Weight	Approx. 47 g (1.7 oz) (excluding plug adapter) For Argentina and Korea: Approx. 72 g (2.6 oz)

Specifications

- Nikon will not be held liable for any errors this manual may contain.
- The appearance of this product and its specifications are subject to change without notice.

Approved Memory Cards

The following Secure Digital (SD) memory cards have been tested and approved for use in this camera.

- Memory cards with an SD Speed Class rating of 6 or faster are recommended for recording movies. When using a memory card with a lower Speed Class rating, movie recording may stop unexpectedly.

	SD memory card	SDHC memory card ²	SDXC memory card ³
SanDisk	2 GB ¹	4 GB, 8 GB, 16 GB, 32 GB	64 GB, 128 GB
TOSHIBA	–	4 GB, 8 GB, 16 GB, 32 GB	64 GB
Panasonic	2 GB ¹	4 GB, 8 GB, 16 GB, 32 GB	64 GB
Lexar	–	4 GB, 8 GB, 16 GB, 32 GB	64 GB, 128 GB

¹ If the memory card will be used with a card reader or similar device, make sure that the device supports 2 GB cards.

² SDHC compliant.

If the memory card will be used with a card reader or similar device, make sure that the device supports SDHC.



³ SDXC compliant.

If the memory card will be used with a card reader or similar device, make sure that the device supports SDXC.



- Contact the manufacturer for details on the above cards. We cannot guarantee camera performance when using memory cards made by other manufacturers.

AVC Patent Portfolio License

This product is licensed under the AVC Patent Portfolio License for the personal and non-commercial use of a consumer to (i) encode video in compliance with the AVC standard ("AVC video") and/or (ii) decode AVC video that was encoded by a consumer engaged in a personal and non-commercial activity and/or was obtained from a video provider licensed to provide AVC video. No license is granted or shall be implied for any other use. Additional information may be obtained from MPEG LA, L.L.C.

See **<http://www.mpegla.com>**.

Trademark Information

- Microsoft, Windows and Windows Vista are either registered trademarks or trademarks of Microsoft Corporation in the United States and/or other countries.
- Macintosh and Mac OS are trademarks of Apple Inc., registered in the U.S. and other countries. The iFrame logo and the iFrame symbol are trademarks of Apple Inc.
- Adobe and Acrobat are registered trademarks of Adobe Systems Inc.
- SDXC, SDHC and SD Logos are trademarks of SD-3C, LLC.
- PictBridge is a trademark.
- HDMI, HDMI logo and High-Definition Multimedia Interface are trademarks or registered trademarks of HDMI Licensing LLC.

HDMI

- Wi-Fi and the Wi-Fi logo are trademarks or registered trademarks of the Wi-Fi Alliance.
- Android and Google Play are trademarks or registered trademarks of Google, Inc.
- All other trade names mentioned in this manual or the other documentation provided with your Nikon product are trademarks or registered trademarks of their respective holders.

FreeType License (FreeType2)

























- Portions of this software are copyright © 2013 The FreeType Project (<http://www.freetype.org>). All rights reserved.

MIT License (HarfBuzz)









- Portions of this software are copyright © 2013 The HarfBuzz Project (<http://www.freedesktop.org/wiki/Software/HarfBuzz>). All rights reserved.

Index









Symbols

 Scene auto selector	32
 Scene mode	34
SO Special effects mode	40
 Smart portrait mode	42
 Auto mode	22, 44
 Playback mode	28
 Favorite pictures mode	 6
 Auto sort mode	 10
 List by date mode	 11
 Setup menu	78
T (Telephoto)	25
W (Wide-angle)	25
 Playback zoom	68
 Thumbnail playback	69
 Help	34
 Shooting mode button	1, 22
 Playback button	1, 28
 ( movie-record) button	2, 72
MENU button	4, 57, 70, 75, 78
 Delete button	30,  61
 Flash mode	49
 Self-timer	51
 Macro mode	53
 Exposure compensation	54

A

AC adapter	83,  95
AF mode	58,  44
AF assist	1, 79,  79
Album	 9
Aperture value	27
Audio/video cable	84
Audio/video-in jack	84
Auto flash	50
Auto mode	22, 44
Auto off	21, 79,  80
Auto sort mode	 10
Autofocus	58, 75,  48,  68

B

Backlighting 	34, 37
Battery charger	13,  95
Battery latch	10
Battery level indicator	20
Battery-chamber/memory card slot cover	2, 10, 14
Beach 	34
Best Shot Selector	37,  40
Black and white copy 	34, 37
Black-and-white	 43
Blink proof	59,  51
Blink warning	79,  84

Brightness	78,	73
BSS	37,	40
Button sound		80
C		
Charge by computer	79,	83
Charge lamp	2, 13	
Charger	13,	95
Charging AC Adapter	12	
Choose key picture ...	71,	12,
Close-up	34, 36	
Color options	58,	43
Compression ratio		34
Computer	84, 88	
Connector cover	1	
Continuous	58,	39
Copying images	71,	61
Crop		21
Cross process	40	
Cyanotype		43
D		
Date and time	16, 78,	71
Date format	17,	71
Daylight saving time	17, 18,	71
Delete	30,	13,
Digital zoom	25, 79,	79
Direct print	84,	24
D-Lighting	70,	16
DPOF print		31
DSCN		94
E		
Easy panorama	34, 38,	62
Easy panorama playback	38,	65
Exposure compensation	54	
Extension		94
Eye-Fi upload	79,	87
Eyelet for camera strap	1	
F		
Face detection	64	
Face priority		44
Favorite pictures	71,	66
Favorite pictures mode		66
File name		94
Fill flash	50	
Fireworks show	34, 37	
Firmware version	79,	88
Fixed range auto		42
Flash	1, 49	
Flash lamp	2, 49	
Flash mode	49, 50	
Flash off	50	
Focus	26, 58,	44
Focus area	26	
Focus indicator	7	
Focus lock	67	
Food	34, 36	
Format internal memory	79,	81

Format memory cards 15, 79, 81
 Formatting 15, 79, 81
 FSCN 94
 Full-frame playback 68
 Full-time AF 58, 75, 48, 68
G
 Gesture control 46, 78, 76
 Glamour retouch 70, 18
H
 HDMI 82
 HDMI cable 84, 22
 HDMI device control 82
 HDMI micro connector 1
 HDR 37
 Help 34
 High key 40
 High-contrast monochrome 40
 High-speed continuous 39
 HS movie 75, 65, 66
I
 Identifier 94
 Image copy 61
 Image mode 58, 34
 Image review 78, 73
 Image size 58, 34
 Imprinting date and time 18, 75
 Internal memory 15, 20
 Internal memory indicator 7, 9

ISO sensitivity 58, 42
J
 JPG 94
L
 Landscape 34
 Language 79, 82
 Lens 1, 17
 Lens cover 1
 List by date mode 11
 Low key 40
M
 Macro mode 53
 Memory capacity 20
 Memory card 14
 Memory card slot 14
 Microphone 1
 Mirror 40
 Monitor 2, 3, 6, 6
 Monitor settings 78, 73
 Motion detection 79, 78
 MOV 94
 Movie editing 77, 32
 Movie length 72, 73
 Movie menu 75, 64
 Movie options 75, 64
 Movie playback 76
 Movie recording 72
 Multi selector 2, 4

Multi-shot 16..... 40
Museum 34, 37
N
Night landscape 34, 36
Night portrait 34, 35
Nikon Transfer 2..... 87, 89
Nostalgic sepia **SE** 40
Number of exposures remaining
..... 20, 35

O

Open with HS footage
..... 75, 66, 68
Optical zoom 25
Optional accessories 95

P

Painting 40
Panorama Maker..... 87
Paper size 28, 29
Party/indoor 34, 35
Pet portrait auto release 39
Pet portrait 34, 39
Photo info 78, 73
PictBridge..... 84, 24
Playback 28, 68, 76, 60
Playback menu 70, 52
Playback mode 28
Playback zoom..... 68
Pop **POP** 40

Portrait 34
Power..... 20
Power switch 1, 20
Power-on lamp..... 1, 20
Preset manual..... 37
Pre-shooting cache..... 39, 41
Pressing halfway 27
Print..... 70, 84, 27, 29, 52
Print date 18, 78, 75
Print order..... 70, 52
Print order date option
..... 18, 53, 55
Printer 84, 24
Protect..... 70, 57

















Q







Quick effects..... 29, 45, 15, 48
Quick retouch..... 70, 16

R









Recording movies 72
Recording slow motion movies
..... 75, 65, 66
Red-eye correction..... 70, 17
Red-eye reduction..... 50
Remove from favorites 71, 8
Reset all 79, 88
Rotate image..... 70, 59
RSCN..... 94

S

Scene mode	34, 35
Selective color 	40
Self-timer	51
Self-timer lamp	1, 52
Sepia	 43
Sequence display options	71,  12,  63
Setup menu	78
Shooting	22, 24, 26
Shooting menu	58,  34
Shooting mode	22
Shutter sound	 80
Shutter speed	27
Shutter-release button	1, 26
Single	58,  39
Single AF	58, 75,  48,  68
Skin softening	59, 65,  49
Slide show	70,  56
Slow sync	50
Small picture	70,  20
Smart portrait menu	57,  49
Smart portrait mode	42
Smile timer	59,  50
Snow 	34
Soft SO	40
Sound settings	79,  80
Speaker	2

Special effects mode	40
Sports 	34, 35
SSCN	 94
Standard color	58,  43
Strap	3
Subject tracking	 45,  47
Sunset 	34
Super vivid VI	40





T

Target finding AF	58, 63,  46
Time difference	 71
Time zone	18,  71
Time zone and date	16, 78,  71
Toy camera effect 1  1	40
Toy camera effect 2  2	40
Tripod socket	2,  19
TV	84,  22
TV settings	79,  82

U

USB cable	83, 88,  25
USB/audio/video output connector	83, 88

V

Vibration reduction	78,  77
Video mode	 82
ViewNX 2	85
Vivid color	 43
Voice memo	70,  60

Volume 77, 60

W

WAV 94

Welcome screen 78, 70

White balance 58, 36

Wi-Fi options 79, 80, 85

Wind noise reduction 75, 69

Wireless LAN 79, 80, 85

Z

Zoom 25

Zoom control 1, 25

Zoom in 25

Zoom out 25

No reproduction in any form of this manual, in whole or in part (except for brief quotation in critical articles or reviews), may be made without written authorization from NIKON CORPORATION.

NIKON CORPORATION

© 2013 Nikon Corporation



YP3H02(11)
6MN25511-02