

**Nikon**

DIGITAL CAMERA

# D3200

## User's Manual



Nikon Manual Viewer 2

Use the Nikon Manual Viewer 2 app to view manuals anytime, anywhere on your smartphone or tablet.

En

# Product Documentation

## Camera Settings

The explanations in this manual assume that default settings are used.

## Digitutor

“Digitutor”, a series of “watch and learn” manuals in movie form, is available from the following website: [http://www.nikondigitutor.com/index\\_eng.html](http://www.nikondigitutor.com/index_eng.html)

### Nikon Manual Viewer 2



Install the Nikon Manual Viewer 2 app on your smartphone or tablet to view Nikon digital camera manuals, anytime, anywhere. Nikon Manual Viewer 2 can be downloaded free of charge from the App Store and Google Play. Download of the app and any product manuals requires an Internet connection, for which fees may be levied by your phone or Internet service provider.

### For Your Safety

Before using the camera for the first time, read the safety instructions in “For Your Safety” (iv-vii).

## The Reference Manual

For more information on using your Nikon camera, download a pdf copy of the camera *Reference Manual* from the website listed below. The *Reference Manual* can be viewed using Adobe Reader or Adobe Acrobat Reader 5.0 or later.

- 1 On your computer, launch a web browser and open the Nikon manual download site at <http://downloadcenter.nikonimglib.com/>
- 2 Navigate to the page for the desired product and download the manual.

# Package Contents

Confirm that the package contains the following items:

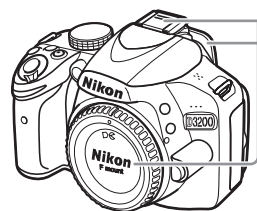

D3200 camera

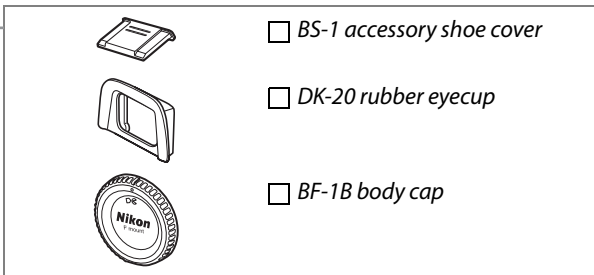

BS-1 accessory shoe cover

DK-20 rubber eyecup

BF-1B body cap

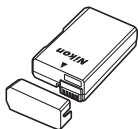

EN-EL14 rechargeable Li-ion battery (with terminal cover)



MH-24 battery charger (plug adapter supplied in countries or regions where required; shape depends on country of sale)

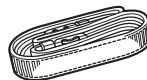

AN-DC3 strap

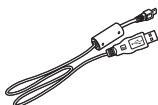

UC-E17 USB cable

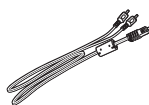

EG-CP14 audio/video cable



DK-5 eyepiece cap (📖 28)

ViewNX 2 CD-ROM

Warranty

User's Manual (this booklet)

Purchasers of the lens kit option should confirm that the package also includes a lens. *Memory cards are sold separately.* Cameras purchased in Japan display menus and messages in English and Japanese only; other languages are not supported. We apologize for any inconvenience this may cause.

## ■ Symbols and Conventions

To make it easier to find the information you need, the following symbols and conventions are used:



This icon marks cautions; information that should be read before use to prevent damage to the camera.



This icon marks notes; information that should be read before using the camera.



This icon marks references to other pages in this manual.

Menu items, options, and messages displayed in the camera monitor are shown in **bold**.

# Table of Contents

Package Contents.....	i
For Your Safety .....	iv
Notices.....	v
<b>Introduction</b>	<b>1</b>
<hr/>	
Getting to Know the Camera.....	1
The Camera Body .....	1
The Mode Dial.....	3
The Viewfinder.....	4
The Information Display.....	5
First Steps .....	6
<b>Basic Photography</b>	<b>12</b>
<hr/>	
Battery Level and Card Capacity .....	12
“Point-and-Shoot” Photography (AUTO and MODE Modes).....	13
Creative Photography (Scene Modes) .....	17
<b>Playback and Deletion</b>	<b>19</b>
<hr/>	
Viewing Photographs .....	19
Display pictures.....	19
Deleting Pictures .....	20
<b>Guide Mode</b>	<b>21</b>
<hr/>	
Guide Mode Menus .....	22
Using the Guide .....	24
<b>More on Photography</b>	<b>25</b>
<hr/>	
Release Mode .....	25
Self-Timer and Remote Control Modes .....	27
Focus .....	29
Focus Mode .....	29
AF-Area Mode .....	31
Image Quality and Size .....	32
Image Quality.....	32
Image Size .....	33
Using the Built-in Flash.....	34
Flash Mode.....	35
ISO Sensitivity .....	37

<b>P, S, A, and M Modes</b>	<b>38</b>
Mode <b>P</b> (Programmed Auto) .....	38
Mode <b>S</b> (Shutter-Priority Auto) .....	39
Mode <b>A</b> (Aperture-Priority Auto).....	39
Mode <b>M</b> (Manual).....	40
<b>Live View</b>	<b>41</b>
Framing Photographs in the Monitor .....	41
Focusing in Live View .....	42
<b>Recording and Viewing Movies</b>	<b>49</b>
Recording Movies .....	49
Movie Settings .....	51
Viewing Movies .....	53
<b>Menu Guide</b>	<b>54</b>
Menu Guide .....	55
Using Camera Menus.....	56
<b>ViewNX 2</b>	<b>58</b>
Installing ViewNX 2 .....	58
Using ViewNX 2 .....	60
Copy Pictures to the Computer .....	60
View Pictures .....	61
<b>Technical Notes</b>	<b>62</b>
Compatible Lenses.....	62
Other Accessories .....	63
Approved Memory Cards.....	64
Caring for the Camera.....	65
Storage.....	65
Cleaning .....	65
Caring for the Camera and Battery: Cautions .....	66
Caring for the Camera .....	66
Caring for the Battery .....	67
Error Messages.....	69
Specifications .....	72

# For Your Safety

To prevent damage to your Nikon product or injury to yourself or to others, read the following safety precautions in their entirety before using this equipment. Keep these safety instructions where all those who use the product will read them.

The consequences that could result from failure to observe the precautions listed in this section are indicated by the following symbol:



This icon marks warnings. To prevent possible injury, read all warnings before using this Nikon product.

## ■ WARNINGS

### **Keep the sun out of the frame**

Keep the sun well out of the frame when shooting backlit subjects. Sunlight focused into the camera when the sun is in or close to the frame could cause a fire.

### **Do not look at the sun through the viewfinder**

Viewing the sun or other strong light source through the viewfinder could cause permanent visual impairment.

### **Using the viewfinder diopter adjustment control**

When operating the viewfinder diopter adjustment control with your eye to the viewfinder, care should be taken not to put your finger in your eye accidentally.

### **Turn off immediately in the event of malfunction**

Should you notice smoke or an unusual smell coming from the equipment or AC adapter (available separately), unplug the AC adapter and remove the battery immediately, taking care to avoid burns. Continued operation could result in injury. After removing the battery, take the equipment to a Nikon-authorized service center for inspection.

### **Do not use in the presence of flammable gas**

Do not use electronic equipment in the presence of flammable gas, as this could result in explosion or fire.

### **Keep out of reach of children**

Failure to observe this precaution could result in injury. In addition, note that small parts constitute a choking hazard. Should a child swallow any part of this equipment, consult a physician immediately.

### **Do not disassemble**

Touching the product's internal parts could result in injury. In the event of malfunction, the product should be repaired only by a qualified technician. Should the product break open as the result of a fall or other accident, remove the battery and/or AC adapter and then take the product to a Nikon-authorized service center for inspection.

### **Do not place the strap around the neck of an infant or child**

Placing the camera strap around the neck of an infant or child could result in strangulation.

### **Do not remain in contact with the camera, battery, or charger for extended periods while the devices are on or in use**

Parts of the device become hot. Leaving the device in direct contact with the skin for extended periods may result in low-temperature burns.

### **Do not aim a flash at the operator of a motor vehicle**

Failure to observe this precaution could result in accidents.

### **Observe caution when using the flash**

- Using the camera with the flash in close contact with the skin or other objects could cause burns.
- Using the flash close to the subject's eyes could cause temporary visual impairment. Particular care should be observed when photographing infants, when the flash should be no less than one meter (39 in.) from the subject.

### **Avoid contact with liquid crystal**

Should the monitor break, care should be taken to avoid injury due to broken glass and to prevent the liquid crystal from the monitor touching the skin or entering the eyes or mouth.

### **Observe proper precautions when handling batteries**

Batteries may leak or explode if improperly handled. Observe the following precautions when handling batteries for use in this product:

- Use only batteries approved for use in this equipment.
- Do not short or disassemble the battery.
- Be sure the product is off before replacing the battery. If you are using an AC adapter, be sure it is unplugged.
- Do not attempt to insert the battery upside down or backwards.
- Do not expose the battery to flame or to excessive heat.
- Do not immerse in or expose to water.
- Replace the terminal cover when transporting the battery. Do not transport or store the battery with metal objects such as necklaces or hairpins.
- Batteries are prone to leakage when fully discharged. To avoid damage to the product, be sure to remove the battery when no charge remains.
- When the battery is not in use, attach the terminal cover and store in a cool, dry place.
- The battery may be hot immediately after use or when the product has been used on battery power for an extended period. Before removing the battery turn the camera off and allow the battery to cool.
- Discontinue use immediately should you notice any changes in the battery, such as discoloration or deformation.

**⚠ Observe proper precautions when handling the charger**

- Keep dry. Failure to observe this precaution could result in fire or electric shock.
- Do not short the charger terminals. Failure to observe this precaution could result in overheating and damage to the charger.
- Dust on or near the metal parts of the plug should be removed with a dry cloth. Continued use could result in fire.
- Do not go near the charger during thunderstorms. Failure to observe this precaution could result in electric shock.
- Do not handle the plug or charger with wet hands. Failure to observe this precaution could result in electric shock.

- Do not use with travel converters or adapters designed to convert from one voltage to another or with DC-to-AC inverters. Failure to observe this precaution could damage the product or cause overheating or fire.

**⚠ Use appropriate cables**

When connecting cables to the input and output jacks, use only the cables provided or sold by Nikon for the purpose to maintain compliance with product regulations.

**⚠ CD-ROMs**

CD-ROMs containing software or manuals should not be played back on audio CD equipment. Playing CD-ROMs on an audio CD player could cause hearing loss or damage the equipment.

## Notices

- No part of the manuals included with this product may be reproduced, transmitted, transcribed, stored in a retrieval system, or translated into any language in any form, by any means, without Nikon's prior written permission.
- Nikon reserves the right to change the specifications of the hardware and software described in these manuals at any time and without prior notice.
- Nikon will not be held liable for any damages resulting from the use of this product.
- While every effort has been made to ensure that the information in these manuals is accurate and complete, we would appreciate it were you to bring any errors or omissions to the attention of the Nikon representative in your area (address provided separately).

### Notices for Customers in the U.S.A.

#### The Battery Charger

## IMPORTANT SAFETY INSTRUCTIONS—SAVE THESE INSTRUCTIONS DANGER—TO REDUCE THE RISK OF FIRE OR ELECTRIC SHOCK, CAREFULLY FOLLOW THESE INSTRUCTIONS

For connection to a supply not in the U.S.A., use an attachment plug adapter of the proper configuration for the power outlet if needed. This power unit is intended to be correctly oriented in a vertical or floor mount position.

### Federal Communications Commission (FCC) Radio Frequency Interference Statement

This equipment has been tested and found to comply with the limits for a Class B digital device, pursuant to Part 15 of the FCC rules. These limits are designed to provide reasonable protection against harmful interference in a residential installation. This equipment generates, uses, and can radiate radio frequency energy and, if not installed and used in accordance with the instructions, may cause harmful interference to radio communications. However, there is no guarantee that interference will not occur in a particular installation. If this equipment does cause harmful interference to radio or television reception, which can be determined by turning the equipment off and on, the user is encouraged to try to correct the interference by one or more of the following measures:

- Reorient or relocate the receiving antenna.
- Increase the separation between the equipment and receiver.
- Connect the equipment into an outlet on a circuit different from that to which the receiver is connected.
- Consult the dealer or an experienced radio/television technician for help.



#### CAUTIONS

##### Modifications

The FCC requires the user be notified that any changes or modifications made to this device that are not expressly approved by Nikon Corporation may void the user's authority to operate the equipment.

##### Interface Cables

Use the interface cables sold or provided by Nikon for your equipment. Using other interface cables may exceed the limits of Class B Part 15 of the FCC rules.

##### Notice for Customers in the State of California

**WARNING:** Handling the cord on this product may expose you to lead, a chemical known to the State of California to cause birth defects or other reproductive harm. *Wash hands after handling.*

Nikon Inc., 1300 Walt Whitman Road, Melville, New York  
11747-3064, U.S.A.  
Tel.: 631-547-4200

## Notice for Customers in Canada

CAN ICES-3 B / NMB-3 B

## Notices for Customers in Europe

### CAUTION

RISK OF EXPLOSION IF BATTERY IS REPLACED BY AN INCORRECT TYPE. DISPOSE OF USED BATTERIES ACCORDING TO THE INSTRUCTIONS.

This symbol indicates that electrical and electronic equipment is to be collected separately.

The following apply only to users in European countries:

- This product is designated for separate collection at an appropriate collection point. Do not dispose of as household waste.
- Separate collection and recycling helps conserve natural resources and prevent negative consequences for human health and the environment that might result from incorrect disposal.
- For more information, contact the retailer or the local authorities in charge of waste management.



This symbol on the battery indicates that the battery is to be collected separately.

The following apply only to users in European countries:

- All batteries, whether marked with this symbol or not, are designated for separate collection at an appropriate collection point. Do not dispose of as household waste.
- For more information, contact the retailer or the local authorities in charge of waste management.



### Notice Concerning Prohibition of Copying or Reproduction

Note that simply being in possession of material that has been digitally copied or reproduced by means of a scanner, digital camera, or other device may be punishable by law.

#### • Items prohibited by law from being copied or reproduced

Do not copy or reproduce paper money, coins, securities, government bonds, or local government bonds, even if such copies or reproductions are stamped "Sample."

The copying or reproduction of paper money, coins, or securities which are circulated in a foreign country is prohibited.

Unless the prior permission of the government has been obtained, the copying or reproduction of unused postage stamps or post cards issued by the government is prohibited.

The copying or reproduction of stamps issued by the government and of certified documents stipulated by law is prohibited.

#### • Cautions on certain copies and reproductions

The government has issued cautions on copies or reproductions of securities issued by private companies (shares, bills, checks, gift certificates, etc.), commuter passes, or coupon tickets, except when a minimum of necessary copies are to be provided for business use by a company. Also, do not copy or reproduce passports issued by the government, licenses issued by public agencies and private groups, ID cards, and tickets, such as passes and meal coupons.

#### • Comply with copyright notices

The copying or reproduction of copyrighted creative works such as books, music, paintings, woodcuts, prints, maps, drawings, movies, and photographs is governed by national and international copyright laws. Do not use this product for the purpose of making illegal copies or to infringe copyright laws.

### Disposing of Data Storage Devices

Please note that deleting images or formatting memory cards or other data storage devices does not completely erase the original image data. Deleted files can sometimes be recovered from discarded storage devices using commercially available software, potentially resulting in the malicious use of personal image data. Ensuring the privacy of such data is the user's responsibility.

Before discarding a data storage device or transferring ownership to another person, erase all data using commercial deletion software, or format the device and then completely refill it with images containing no private information (for example, pictures of empty sky). Be sure to also replace any pictures selected for preset manual. Care should be taken to avoid injury when physically destroying data storage devices.



### AVC Patent Portfolio License

THIS PRODUCT IS LICENSED UNDER THE AVC PATENT PORTFOLIO LICENSE FOR THE PERSONAL AND NON-COMMERCIAL USE OF A CONSUMER TO (i) ENCODE VIDEO IN COMPLIANCE WITH THE AVC STANDARD ("AVC VIDEO") AND/OR (ii) DECODE AVC VIDEO THAT WAS ENCODED BY A CONSUMER ENGAGED IN A PERSONAL AND NON-COMMERCIAL ACTIVITY AND/OR WAS OBTAINED FROM A VIDEO PROVIDER LICENSED TO PROVIDE AVC VIDEO. NO LICENSE IS GRANTED OR SHALL BE IMPLIED FOR ANY OTHER USE. ADDITIONAL INFORMATION MAY BE OBTAINED FROM MPEG LA, L.L.C. SEE <http://www.mpegla.com>

### Use Only Nikon Brand Electronic Accessories

Nikon cameras are designed to the highest standards and include complex electronic circuitry. Only Nikon brand electronic accessories (including chargers, batteries, AC adapters, and flash accessories) certified by Nikon specifically for use with this Nikon digital camera are engineered and proven to operate within the operational and safety requirements of this electronic circuitry.

The use of non-Nikon electronic accessories could damage the camera and may void your Nikon warranty. The use of third-party rechargeable Li-ion batteries not bearing the Nikon holographic seal shown at right could interfere with normal operation of the camera or result in the batteries overheating, igniting, rupturing, or leaking.

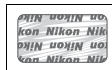

For more information about Nikon brand accessories, contact a local authorized Nikon dealer.

#### Use Only Nikon Brand Accessories

Only Nikon brand accessories certified by Nikon specifically for use with your Nikon digital camera are engineered and proven to operate within its operational and safety requirements. THE USE OF NON-NIKON ACCESSORIES COULD DAMAGE YOUR CAMERA AND MAY VOID YOUR NIKON WARRANTY.

#### Servicing the Camera and Accessories

The camera is a precision device and requires regular servicing. Nikon recommends that the camera be inspected by the original retailer or a Nikon-authorized service representative once every one to two years, and that it be serviced once every three to five years (note that fees apply to these services). Frequent inspection and servicing are particularly recommended if the camera is used professionally. Any accessories regularly used with the camera, such as lenses or optional flash units, should be included when the camera is inspected or serviced.

#### Before Taking Important Pictures

Before taking pictures on important occasions (such as at weddings or before taking the camera on a trip), take a test shot to ensure that the camera is functioning normally. Nikon will not be held liable for damages or lost profits that may result from product malfunction.

#### Life-Long Learning

As part of Nikon's "Life-Long Learning" commitment to ongoing product support and education, continually-updated information is available on-line at the following sites:

- For users in the U.S.A.: <http://www.nikonusa.com/>
- For users in Europe and Africa: <http://www.europe-nikon.com/support/>
- For users in Asia, Oceania, and the Middle East: <http://www.nikon-asia.com/>

Visit these sites to keep up-to-date with the latest product information, tips, answers to frequently-asked questions (FAQs), and general advice on digital imaging and photography. Additional information may be available from the Nikon representative in your area. See the following URL for contact information: <http://imaging.nikon.com/>



# Introduction



## Getting to Know the Camera

Take a few moments to familiarize yourself with camera controls and displays. You may find it helpful to bookmark this section and refer to it as you read through the rest of the manual.

### The Camera Body

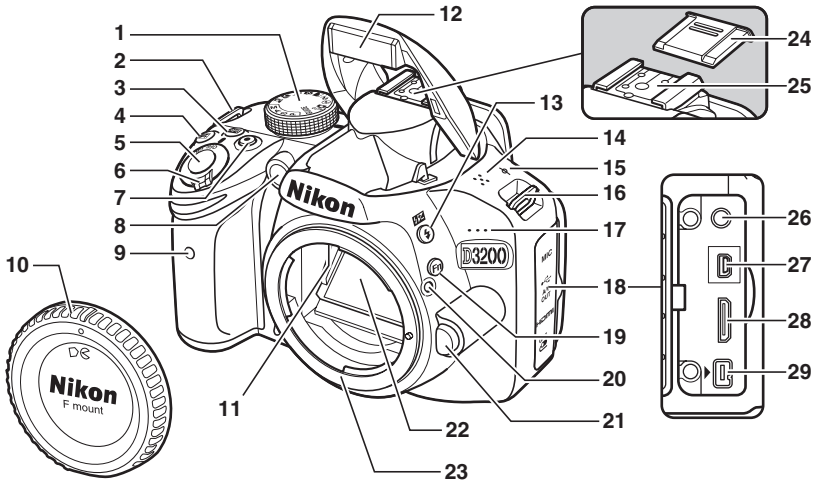

<b>1</b> Mode dial.....3	<b>12</b> Built-in flash.....34	<b>25</b> Accessory shoe (for optional flash units)
<b>2</b> Eyelet for camera strap.....6	<b>13</b> /  button	<b>26</b> Connector for external microphone.....51, 64
<b>3</b> (information) button.....46	Flash mode.....34	<b>27</b> USB and A/V connector
<b>4</b> /  button	Flash compensation	Connecting to a computer.....60
Exposure compensation	<b>14</b> Speaker.....51	<b>28</b> HDMI mini-pin connector
Adjusting aperture.....40	<b>15</b> Focal plane mark (⊖)	<b>29</b> Accessory terminal.....64
Flash compensation	<b>16</b> Eyelet for camera strap.....6	
<b>5</b> Shutter-release button...15, 16	<b>17</b> Microphone.....53	
<b>6</b> Power switch.....2	<b>18</b> Connector cover	
<b>7</b> Movie-record button.....49	<b>19</b> Fn button	
<b>8</b> AF-assist illuminator	Using the Fn button	
Self-timer lamp.....27	<b>20</b> Mounting mark.....7	
Red-eye reduction lamp.....36	<b>21</b> Lens release button.....11	
<b>9</b> Infrared receiver (front).....27	<b>22</b> Mirror	
<b>10</b> Body cap	<b>23</b> Lens mount	
<b>11</b> CPU contacts	<b>24</b> Accessory shoe cover	

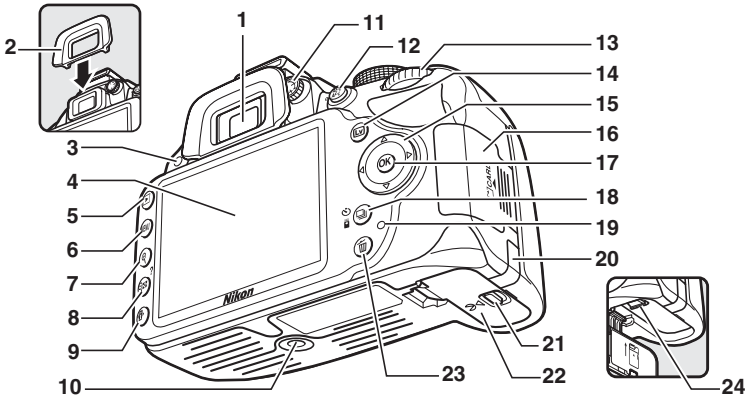

1 Viewfinder eyepiece.....	9	10 Tripod socket		19 Memory card access lamp	
2 Rubber eyecup		11 Diopter adjustment		..... 15, 26	
3 Infrared receiver (rear).....	27	12 $\text{AE-L}/\text{O-ON}$ button	9	20 Power connector cover for	
4 Monitor		Using the $\text{AE-L}$ ( $\text{O-ON}$ ) button		optional power connector	
Viewing settings .....	5	Protecting photographs		21 Battery-chamber cover latch	
Live view .....	41	from deletion		.....6	
Viewing photographs.....	19	13 Command dial		22 Battery-chamber cover .....	6
5 $\text{▶}$ button		14 $\text{L}$ button		23 $\text{⌫}$ button	
Playback.....	19	Live view.....	41	Deleting pictures .....	20
6 MENU button		Movie .....	49	24 Battery latch.....	6, 9
Menu.....	54	15 Multi selector .....	56		
7 $\text{Q}$ button		16 Memory card slot cover .....	7		
Playback zoom in		17 $\text{OK}$ (OK) button .....	56		
8 $\text{Q}/\text{?}$ button		18 $\text{M}/\text{ON}/\text{⌫}$ button			
Thumbnails/playback zoom		Release mode.....	25		
out.....	20	Self-timer/			
Help.....	54	Remote control.....	27		
9 $\text{i}$ (information edit) button					
.....	5				

### The Power Switch

Rotate the power switch as shown to turn the camera on.

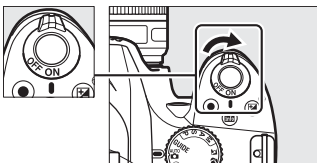

Rotate the power switch as shown to turn the camera off.

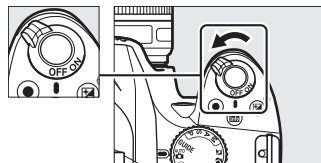

### The Microphone and Speaker

Do not place the microphone or speaker in close proximity to magnetic devices. Failure to observe this precaution could affect the data recorded on the magnetic devices.

# The Mode Dial

The camera offers a choice of the following shooting modes and **GUIDE** mode:

## GUIDE Mode (📖 21)

Take and view pictures and adjust settings with the help of an on-screen guide.

## P, S, A, and M Modes (📖 38)

Select these modes for full control over camera settings.

- **P**—Programmed auto
- **S**—Shutter-priority auto
- **A**—Aperture-priority auto
- **M**—Manual

## Auto Modes

Select these modes for simple, point-and-shoot photography.

-  **Auto** (📖 13)
-  **Auto (flash off)** (📖 13)

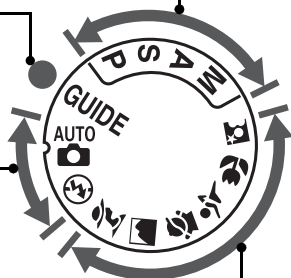



## Scene Modes

The camera automatically optimizes settings to suit the scene selected with the mode dial. Match your selection to the scene being photographed.

-  **Portrait** (📖 17)
-  **Landscape** (📖 17)
-  **Child** (📖 17)
-  **Sports** (📖 18)
-  **Close up** (📖 18)
-  **Night portrait** (📖 18)

## Scene Auto Selector (Live View)

Selecting live view in  or  mode enables automatic scene selection (“scene auto selector”; 📖 46) when autofocus is used.

# The Viewfinder

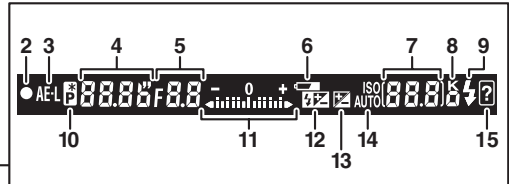
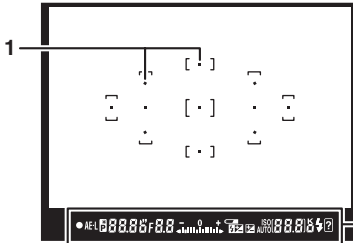
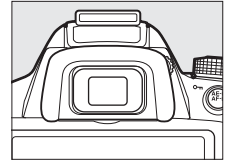

<p><b>1</b> Focus points</p> <p><b>2</b> Focus indicator .....14</p> <p><b>3</b> Autoexposure (AE) lock indicator</p> <p><b>4</b> Shutter speed ..... 39, 40</p> <p><b>5</b> Aperture (f-number) ..... 39, 40</p> <p><b>6</b> Battery indicator .....12</p>	<p><b>7</b> Number of exposures remaining ..... 12</p> <p>Number of shots remaining before memory buffer fills .....26</p> <p>White balance recording indicator</p> <p>Exposure compensation value</p> <p>Flash compensation value</p> <p>ISO sensitivity..... 37</p> <p><b>8</b> "K" (appears when memory remains for over 1000 exposures) ..... 12</p>	<p><b>9</b> Flash-ready indicator .....16</p> <p><b>10</b> Flexible program indicator</p> <p><b>11</b> Exposure indicator.....40</p> <p>Exposure compensation display</p> <p>Electronic rangefinder</p> <p><b>12</b> Flash compensation indicator</p> <p><b>13</b> Exposure compensation indicator</p> <p><b>14</b> Auto ISO sensitivity indicator</p> <p><b>15</b> Warning indicator</p>
-------------------------------------------------------------------------------------------------------------------------------------------------------------------------------------------------------------------------------------------------------------	----------------------------------------------------------------------------------------------------------------------------------------------------------------------------------------------------------------------------------------------------------------------------------------------------------------------------------------------------------	-------------------------------------------------------------------------------------------------------------------------------------------------------------------------------------------------------------------------------------------------------------------------------------------------------------------------------------------------------------------------------------------

## The Viewfinder

The response time and brightness of the viewfinder display may vary with temperature.

# The Information Display

Camera settings can be viewed and adjusted in the information display. Press the **INFO** button once to view settings, and again to make changes to settings. Highlight items using the multi-selector and press **OK** to view options for the highlighted item.

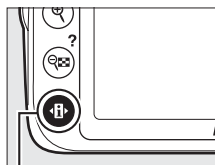

**INFO** button

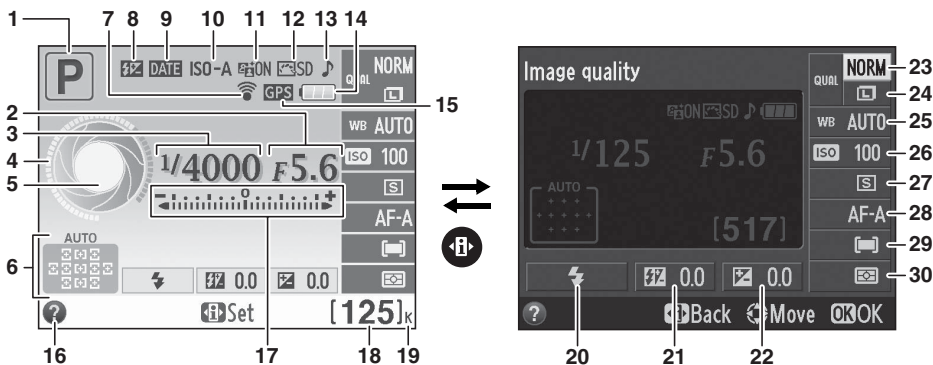

<b>1</b> Shooting mode <b>auto/</b> <b>auto (flash off)</b> ..... 13 Scene modes..... 17 Guide mode ..... 21 <b>P, S, A, and M</b> modes..... 38	<b>10</b> Auto ISO sensitivity indicator	<b>20</b> Flash mode ..... 35
<b>2</b> Aperture (f-number) ..... 39, 40	<b>11</b> Active D-Lighting	<b>21</b> Flash compensation
<b>3</b> Shutter speed ..... 39, 40	<b>12</b> Picture Control	<b>22</b> Exposure compensation
<b>4</b> Shutter-speed display	<b>13</b> "Beep" indicator	<b>23</b> Image quality ..... 32
<b>5</b> Aperture display	<b>14</b> Battery indicator ..... 12	<b>24</b> Image size ..... 33
<b>6</b> Auto-area AF indicator ..... 31 3D-tracking indicator..... 31 Focus point	<b>15</b> GPS connection indicator	<b>25</b> White balance
<b>7</b> Eye-Fi connection indicator	<b>16</b> Help icon	<b>26</b> ISO sensitivity..... 37
<b>8</b> Manual flash indicator Flash compensation indicator for optional flash units	<b>17</b> Exposure indicator ..... 40 Exposure compensation indicator	<b>27</b> Release mode..... 25
<b>9</b> Print date indicator	<b>18</b> Number of exposures remaining ..... 12 White balance recording indicator	<b>28</b> Focus mode ..... 29, 42
	<b>19</b> "K" (appears when memory remains for over 1000 exposures)..... 12	<b>29</b> AF-area mode ..... 31, 43
		<b>30</b> Metering

# First Steps

Always turn the camera off before inserting or removing batteries or memory cards.

## 1 Attach the strap.

Attach the strap securely to the two eyelets on the camera body as shown below.

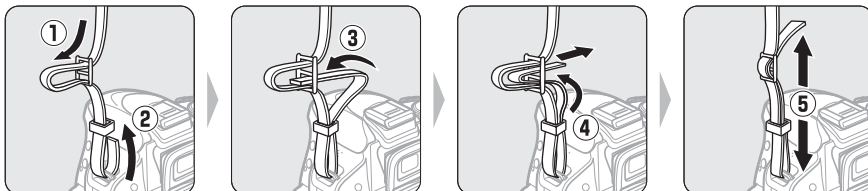

## 2 Charge the battery.

If a plug adapter is supplied, raise the wall plug and connect the plug adapter as shown below at left, making sure the plug is fully inserted. Insert the battery and plug the charger in. An exhausted battery will fully charge in about an hour and thirty minutes.

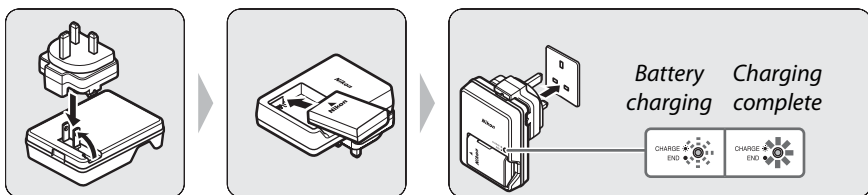

## 3 Insert the battery.

Insert the battery in the orientation shown (3), using the battery to keep the orange battery latch pressed to one side. The latch locks the battery in place when the battery is fully inserted (4).

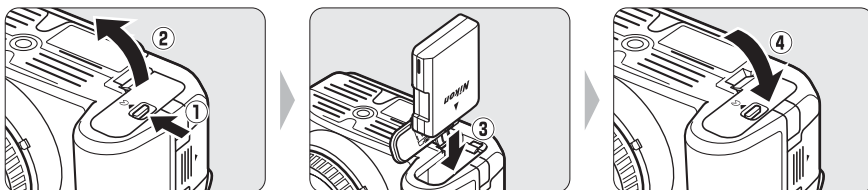

## 4 Insert a memory card (available separately).

Check to be sure the card is in the correct orientation and then slide the card until it clicks into place.

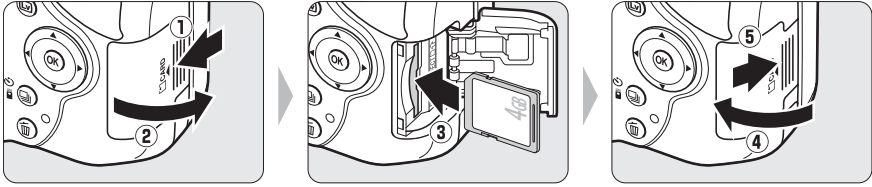

## 5 Attach a lens.

Be careful to prevent dust from entering the camera when the lens or body cap is removed.

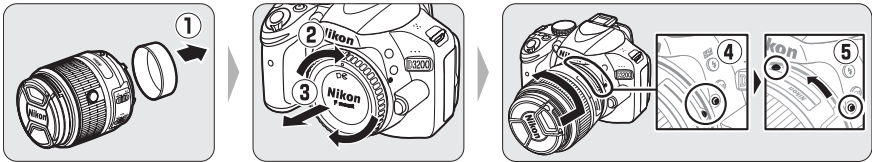

*Keeping marks aligned, position lens on camera, then rotate until lens clicks into place.*

Autofocus is available with AF-S lenses. When using autofocus with a lens equipped with an **A-M** mode switch, slide the switch to **A** (if the lens has an **M/A-M** switch, select **M/A** for autofocus with manual override). For information on other lenses that can be used with the D3200, see page 62.



If the lens has a vibration reduction (VR) switch, select **ON** to reduce the effects of vibration.



## 6 Turn the camera on.

A language-selection dialog will be displayed.

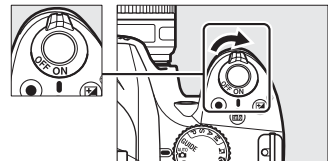



## 7 Choose a language and set the camera clock.

Use the multi selector and **OK** button to select a language and set the camera clock.

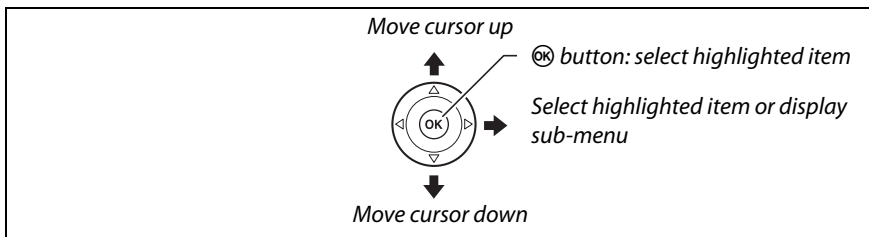

Select language



Select time zone

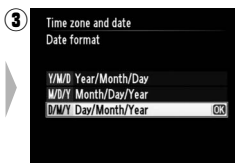

Select date format

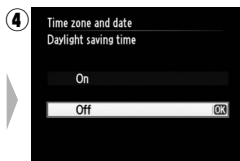

Select daylight saving time option



Set time and date

**Note:** The language and date/time can be changed at any time using the **Language and Time zone and date** options in the setup menu (55).

### Lenses with Retractable Lens Barrel Buttons

Before using the camera, unlock and extend the zoom ring. Keeping the retractable lens barrel button pressed (1), rotate the zoom ring as shown (2).

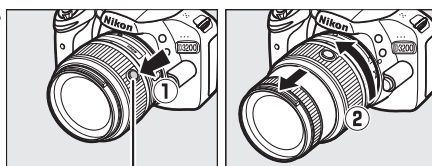

Retractable lens barrel button

Pictures can not be taken when the lens is retracted; if an error message is displayed as a result of the camera having been turned on with the lens retracted, rotate the zoom ring until the message is no longer displayed.

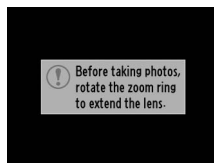

## 8 Focus the viewfinder.

After removing the lens cap, rotate the diopter adjustment control until the viewfinder display and focus point are in sharp focus. When operating the control with your eye to the viewfinder, be careful not to put your fingers or fingernails in your eye.

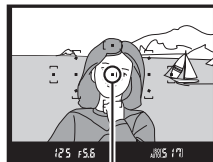
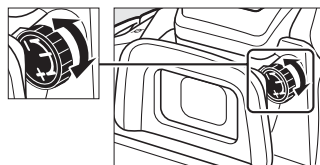

Focus point

### ✓ During Charging

Do not move the charger or touch the battery during charging. Failure to observe this precaution could in very rare instances result in the charger showing that charging is complete when the battery is only partially charged. Remove and reinsert the battery to begin charging again.

### ✓ Charging the Battery

Read and follow the warnings and cautions on pages iv–v and 66–68 of this manual. Charge the battery indoors at ambient temperatures of 5–35 °C (41–95 °F). Do not use the battery at ambient temperatures below 0 °C/32 °F or above 40 °C/104 °F; failure to observe this precaution could damage the battery or impair its performance. Capacity may be reduced and charging times may increase at battery temperatures from 0 °C/32 °F to 15 °C/59 °F and from 45 °C/113 °F to 60 °C/140 °F. The battery will not charge if its temperature is below 0 °C (32 °F) or above 60 °C (140 °F). If the **CHARGE** lamp flashes quickly (about eight times a second) during charging, confirm that the temperature is in the correct range and then unplug the charger and remove and reinsert the battery. If the problem persists, cease use immediately and take battery and charger to your retailer or a Nikon-authorized service representative.

Do not attempt to charge a fully-charged battery. Failure to observe this precaution will result in reduced battery performance.

Use the charger with compatible batteries only. Unplug when not in use.

### ✎ Removing the Battery

Turn the camera off and open the battery-chamber cover. Press the battery latch in the direction shown by the arrow to release the battery and then remove the battery by hand.

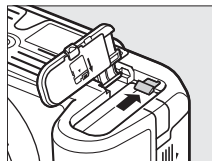

## ✔ Formatting Memory Cards

If this is the first time the memory card will be used in the camera or if the card has been formatted in another device, select **Format memory card** in the setup menu and follow the on-screen instructions to format the card (☞ 55). *Note that this permanently deletes any data the card may contain.* Be sure to copy any photographs and other data you wish to keep to a computer before proceeding.

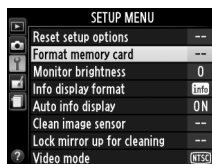

## ✔ Memory Cards

- Memory cards may be hot after use. Observe due caution when removing memory cards from the camera.
- Turn the power off before inserting or removing memory cards. Do not remove memory cards from the camera, turn the camera off, or remove or disconnect the power source during formatting or while data are being recorded, deleted, or copied to a computer. Failure to observe these precautions could result in loss of data or in damage to the camera or card.
- Do not touch the card terminals with your fingers or metal objects.
- Do not bend, drop, or subject to strong physical shocks.
- Do not apply force to the card casing. Failure to observe this precaution could damage the card.
- Do not expose to water, heat, high levels of humidity, or direct sunlight.
- Do not format memory cards in a computer.

## ✎ Removing Memory Cards

After confirming that the memory card access lamp is off, turn the camera off, open the memory card slot cover, and press the card in to eject it (①). The card can then be removed by hand (②).

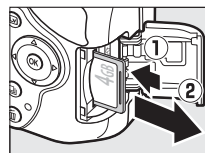

## ✎ The Write Protect Switch

SD memory cards are equipped with a write protect switch to prevent accidental loss of data. When this switch is in the “lock” position, the memory card can not be formatted and photos can not be deleted or recorded (a beep will sound if you attempt to release the shutter). To unlock the memory card, slide the switch to the “write” position.

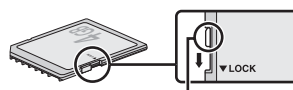

Write-protect switch

## ✎ CPU Lenses with Aperture Rings

In the case of CPU lenses equipped with an aperture ring (☞ 62), lock aperture at the minimum setting (highest f-number).

### **Detaching the Lens**

Be sure the camera is off when removing or exchanging lenses. To remove the lens, press and hold the lens release button (1) while turning the lens clockwise (2). After removing the lens, replace the lens caps and camera body cap.

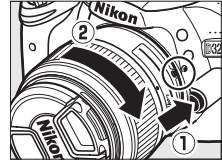

### **Retracting Lenses with Retractable Lens Barrel Buttons**



To retract the lens when the camera is not in use, hold the retractable lens barrel button (1) and rotate the zoom ring to the "L" (lock) position as shown (2). Retract the lens before removing it from the camera, and be careful not to press the retractable lens barrel button when attaching or removing the lens.



### **The Camera Clock**

The camera clock is less accurate than most watches and household clocks. Check the clock regularly against more accurate time pieces and reset as necessary.

### **Adjusting Viewfinder Focus**

If you are unable to focus the viewfinder as described above, select single-servo autofocus (AF-S;  29), single-point AF (L\*;  31), and the center focus point, and then frame a high-contrast subject in the center focus point and press the shutter-release button halfway to focus the camera. With the camera in focus, use the diopter adjustment control to bring the subject into clear focus in the viewfinder. If necessary, viewfinder focus can be further adjusted using optional corrective lenses.

### **The Setup Menu**

Language and date/time settings can be changed at any time using the **Language** and **Time zone and date** options in the setup menu.



# Basic Photography

## Battery Level and Card Capacity







Before shooting, check the battery level and number of exposures remaining.

### 1 Turn the camera on.



### 2 Check the battery level.

Check the battery level in the information display (if the battery is low, a warning will also be displayed in the viewfinder). If the monitor is off, press the  button to view the information display; if the monitor does not turn on, the battery is exhausted and must be be recharged.



Information display	Viewfinder	Description
	—	Battery fully charged.
	—	Battery partially discharged.
		Low battery. Ready fully-charged spare battery or prepare to charge battery.
 (flashes)	 (flashes)	Battery exhausted; shutter release disabled. Charge or exchange battery.

### 3 Check the number of exposures remaining.

The information display and viewfinder show the number of photographs that can be taken at current settings (values over 1,000 are rounded down to the nearest hundred; e.g., values between 1,200 and 1,299 are shown as 1.2 K). If a warning is displayed stating that there is not enough memory for additional photographs, insert another memory card ( 7) or delete some photos ( 20).

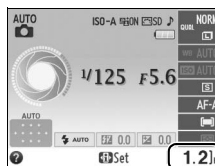

# “Point-and-Shoot” Photography

## (<sup>AUTO</sup> and Modes)

This section describes how to take photographs in <sup>AUTO</sup> and  modes, automatic “point-and-shoot” modes in which the majority of settings are controlled by the camera in response to shooting conditions.



### 1 Turn the camera on.

Remove the lens cap and turn the camera on. The information display will appear in the monitor.

### 2 Select <sup>AUTO</sup> or Mode.

To shoot where use of a flash is prohibited, photograph infants, or capture natural lighting under low light, select auto (flash off) mode by rotating the mode dial to . Otherwise, rotate the dial to <sup>AUTO</sup> (auto).

Mode dial

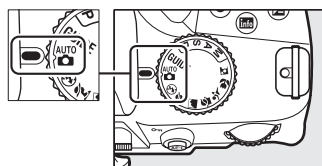

### 3 Ready the camera.

When framing photographs in the viewfinder, hold the handgrip in your right hand and cradle the camera body or lens with your left. Keep your elbows propped lightly against your torso for support and place one foot half a pace ahead of the other to keep your upper body stable. When framing photographs in portrait (tall) orientation, hold the camera as shown at right.

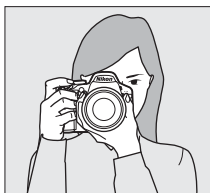

In  mode, shutter speeds slow when lighting is poor; use of a tripod is recommended.

### 4 Frame the photograph.

Frame a photograph in the viewfinder with the main subject in at least one of the 11 focus points.

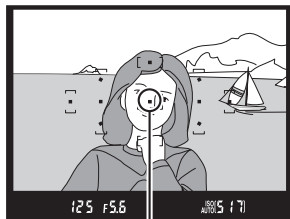

Focus point

## 5 Press the shutter-release button halfway.

Press the shutter-release button halfway to focus. The camera will select the focus points automatically. If the subject is poorly lit, the flash may pop up and the AF-assist illuminator may light.



## 6 Check the indicators in the viewfinder.

When the focus operation is complete, the selected focus points will be briefly highlighted, a beep will sound (a beep may not sound if the subject is moving), and the in-focus indicator (●) will appear in the viewfinder.



*In-focus indicator*

*Buffer capacity*

In-focus indicator	Description
●	Subject in focus.
● (flashes)	Camera unable to focus using autofocus. See page 30.

While the shutter-release button is pressed halfway, the number of exposures that can be stored in the memory buffer ("r"; □ 26) will be displayed in the viewfinder.

### Using a Zoom Lens

Use the zoom ring to zoom in on the subject so that it fills a larger area of the frame, or zoom out to increase the area visible in the final photograph (select longer focal lengths on the lens focal length scale to zoom in, shorter focal lengths to zoom out).

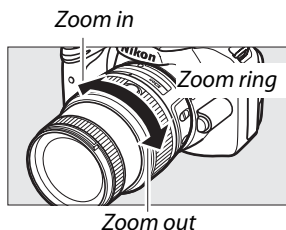

If the lens is equipped with a retractable lens barrel button (□ 8), press and hold the button while rotating the zoom ring until the lens is released and the message shown at right is no longer displayed, and then adjust zoom using the zoom ring.

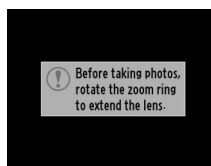

## 7 Shoot.

Smoothly press the shutter-release button the rest of the way down to release the shutter and record the photograph. The memory card access lamp will light and the photograph will be displayed in the monitor for a few seconds (the photo will automatically clear from the display when the shutter-release button is pressed halfway). *Do not eject the memory card or remove or disconnect the power source until the lamp has gone out and recording is complete.*

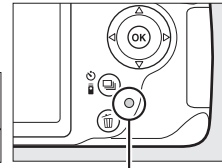

Memory card access lamp



### Image Sensor Cleaning

The camera vibrates the low-pass filter covering the image sensor to remove dust when the camera is turned on or off.



## The Shutter-Release Button

The camera has a two-stage shutter-release button. The camera focuses when the shutter-release button is pressed halfway. To take the photograph, press the shutter-release button the rest of the way down.

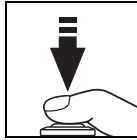
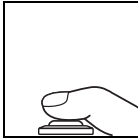

*Focus: press halfway*

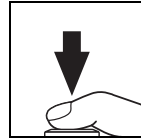

*Shoot: press all the way down*

## The Standby Timer

The viewfinder and information display will turn off if no operations are performed for about 8 seconds, reducing the drain on the battery. Press the shutter-release button halfway to reactivate the display. The length of time before the standby timer expires automatically can be selected using the **Auto off timers** option in the setup menu (□ 55).



## The Built-in Flash

If additional lighting is required for correct exposure in **AUTO** mode, the built-in flash will pop up automatically when the shutter-release button is pressed halfway. If the flash is raised, photographs can only be taken when the flash-ready indicator () is displayed. If the flash-ready indicator is not displayed, the flash is charging; remove your finger briefly from the shutter-release button and try again.

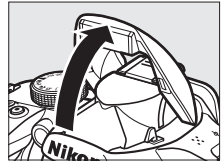

To save battery power when the flash is not in use, return it to its closed position by pressing it gently downward till the latch clicks into place.

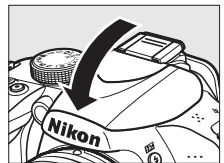

# Creative Photography (Scene Modes)

The camera offers a choice of “scene” modes. Choosing a scene mode automatically optimizes settings to suit the selected scene, making creative photography as simple as selecting a mode, framing a picture, and shooting as described on pages 13–16.



The following scenes can be selected with the mode dial:

Mode dial

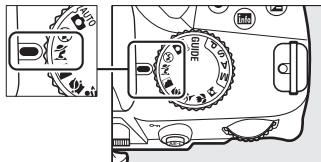

## Portrait



Use for portraits with soft, natural-looking skin tones. If the subject is far from the background or a telephoto lens is used, background details will be softened to lend the composition a sense of depth.

## Landscape



Use for vivid landscape shots in daylight. The built-in flash and AF-assist illuminator turn off; use of a tripod is recommended to prevent blur when lighting is poor.

## Child



Use for snapshots of children. Clothing and background details are vividly rendered, while skin tones remain soft and natural.

## Sports



Fast shutter speeds freeze motion for dynamic sports shots in which the main subject stands out clearly. The built-in flash and AF-assist illuminator turn off.



## Close up



Use for close-up shots of flowers, insects, and other small objects (a macro lens can be used to focus at very close ranges). Use of a tripod is recommended to prevent blur.

## Night Portrait



Use for a natural balance between the main subject and the background in portraits taken under low light. Use of a tripod is recommended to prevent blur.

# Playback and Deletion

Photographs are automatically displayed for a few seconds after shooting. If no photograph is displayed in the monitor, the most recent picture can be viewed by pressing the  button.

## Viewing Photographs



### 1 Press the button.

A photograph will be displayed in the monitor.





 button

### 2 View additional pictures.

Additional pictures can be displayed by pressing  or  or rotating the command dial.



## Display pictures

To display images in “contact sheets” of four, nine, or 72 images (thumbnail playback), press the  (?) button. To view images taken on a selected date (calendar playback), press the  (?) button when 72 images are displayed.

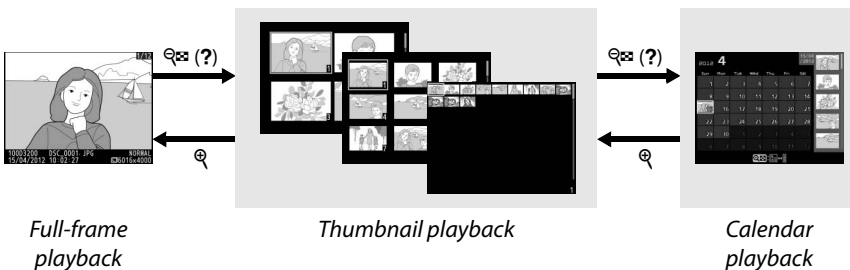

Full-frame playback

Thumbnail playback

Calendar playback

## Thumbnail Playback

Use the multi selector or command dial to highlight images and press **OK** to display the highlighted image full frame. Press **Q** to reduce the number of images displayed.

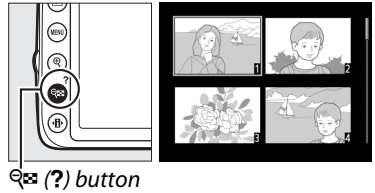

## Calendar Playback

Press the **Q(?)** button to toggle between the date list and the list of thumbnails for the selected date. Use the multi selector to highlight dates in the date list or to highlight pictures in the thumbnail list. Press **Q** when the cursor is in the date list to return to 72-frame playback.



## Deleting Pictures

To delete the photograph currently displayed in full-frame playback or highlighted in thumbnail playback or the thumbnail list, press the **W** button. A confirmation dialog will be displayed; press the **W** button again to delete the image and return to playback (to exit without deleting the picture, press **▶**). Once deleted, photographs can not be recovered.

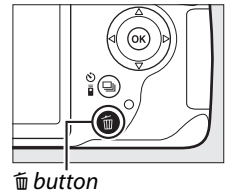

Full-frame playback

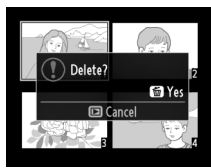

Thumbnail playback



Calendar playback  
(thumbnail list)

# Guide Mode

Guide mode gives access to a variety of frequently-used and useful functions. The top level of the guide is displayed when the mode dial is rotated to **GUIDE**.



**Battery indicator** (🔋 12)

**Number of exposures remaining** (📷 12)

**Shooting mode:** A guide mode indicator appears on the shooting mode icon.

Choose from the following items:

Shoot	View/delete	Set up
<p>Take pictures.</p>	<p>View and/or delete pictures.</p>	<p>Change camera settings.</p>

# Guide Mode Menu

To access these menus, highlight **Shoot**, **View/delete**, or **Set up** and press **OK**.



## Shoot

### Easy operation

<b>Auto</b>
<b>No flash</b>
<b>Distant subjects</b>
<b>Close-ups</b>
<b>Sleeping faces</b>
<b>Moving subjects</b>
<b>Landscapes</b>
<b>Portraits</b>
<b>Night portrait</b>

### Advanced operation

<b>Soften backgrounds</b>	Adjust aperture.
<b>Bring more into focus</b>	
<b>Freeze motion (people)</b>	Select a shutter speed.
<b>Freeze motion (vehicles)</b>	
<b>Show water flowing</b>	
<b>Capture reds in sunsets *</b>	Adjust white balance to vividly capture the colors in sunsets.
<b>Take bright photos *</b>	Adjust exposure compensation to take bright (high key) or dark (low key) photos.
<b>Take dark (low key) photos *</b>	
<b>Reduce blur</b>	Adjust auto ISO sensitivity control for poorly lit subjects or telephoto lenses.

\* Affects other **Advanced operation** items. To restore default settings, turn the camera off and then on again.

## "Start Shooting"



Highlight an option and press **OK**.

- Use the viewfinder
- Use live view
- Shoot movies

## "More Settings"

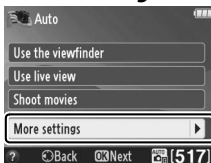

If **More settings** is displayed, you can highlight this option and press **▶** to access the following settings (the settings available vary with the shooting option selected):

- Flash settings > Flash mode
- Flash settings > Flash compensation
- Release mode
- ISO sensitivity settings > ISO sensitivity
- ISO sensitivity settings > Auto ISO sensitivity control
- Set Picture Control
- Exposure compensation
- White balance



## ■ ■ View/Delete

View single photos

View multiple photos

Choose a date

View a slide show

Delete photos

## ■ ■ Set Up

Image quality

Image size

Auto off timers

Print date

Display and sound settings

Monitor brightness

Info background color

Auto info display

Beep

Movie settings

Frame size/frame rate

Movie quality

Microphone

Flicker reduction

Output settings

HDMI

Video mode

Playback folder

Playback display options

DPOF print order

Clock and language

Time zone and date

Language

Format memory card

Eye-Fi upload\*

Slot empty release lock

G

\* Only available when compatible Eye-Fi memory card is inserted.

Changes to **Image quality**, **Image size**, **Auto off timers**, **Print date**, **Playback folder**, **Playback display options**, all **Display and sound settings** options, and all **Movie settings** options except **Flicker reduction** apply in guide mode only and are not reflected in other shooting modes.







### Guide Mode

Guide mode is reset to **Easy operation > Auto** when the mode dial is rotated to another setting or the camera is turned off.

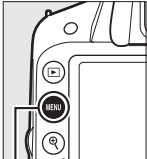

# Using the Guide

The following operations can be performed while the guide is displayed:

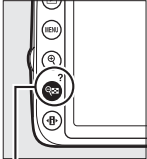
To	Use	Description
Return to top level of guide	 <b>MENU button</b>	Press <b>MENU</b> to turn the monitor on or return to the top level of the guide.
Turn monitor on		
Highlight a menu		Press <b>◀</b> or <b>▶</b> to highlight a menu.
Highlight options		Press <b>▲</b> or <b>▼</b> to highlight options in the menus.
		Press <b>▲</b> , <b>▼</b> , <b>◀</b> , or <b>▶</b> to highlight options in displays like that shown at right.
Select highlighted menu or option		Press <b>OK</b> to select the highlighted menu or option.
Return to previous display		Press <b>◀</b> to return to the previous display.
		To cancel and return to the previous display from displays like that shown at right, highlight <b>◀</b> and press <b>OK</b> .
View help	 <b>Help (?) button</b>	<p>If a <b>?</b> icon is displayed at the bottom left corner of the monitor, help can be displayed by pressing the <b>Help (?)</b> button. A description of the currently selected option will be displayed while the button is pressed. Press <b>▲</b> or <b>▼</b> to scroll through the display.</p>



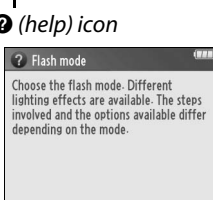
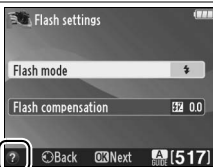



6



# More on Photography

## Release Mode

Choose from the following release modes:

Mode	Description
 <b>S</b>	<b>Single frame:</b> Camera takes one photograph each time shutter-release button is pressed.
 <b>C</b>	<b>Continuous:</b> While shutter-release button is held down, camera records up to 4 frames per second.
 <b>T</b>	<b>Self-timer:</b> Use self-timer for self-portraits or to reduce blurring caused by camera shake (□ 27).
 <b>2s</b>	<b>Delayed remote:</b> Shutter is released 2 s after shutter-release button on optional ML-L3 (□ 64) remote control is pressed (□ 27).
 <b>R</b>	<b>Quick-response remote:</b> Shutter is released when shutter-release button on optional ML-L3 (□ 64) remote control is pressed (□ 27).
 <b>Q</b>	<b>Quiet shutter release:</b> As for single frame, except that mirror does not click back into place while shutter-release button is fully pressed, allowing user to control timing of click made by mirror, which is also quieter than in single frame mode. Also, beep does not sound when camera focuses, keeping noise to a minimum in quiet surroundings.

### 1 Press (/).

A list of release mode options will be displayed.

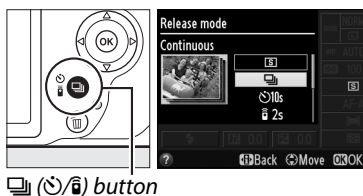

### 2 Choose a release mode.

Highlight a release mode and press  to return to the information display. Photographs can be taken immediately.



## **The Memory Buffer**

The camera is equipped with a memory buffer for temporary storage, allowing shooting to continue while photographs are being saved to the memory card. Up to 100 photographs can be taken in succession; note, however, that frame rate will drop when the buffer is full.

While photographs are being recorded to the memory card, the memory card access lamp will light (□ 2). Depending on the number of the images in the buffer, recording may take from a few seconds to a few minutes. *Do not remove the memory card or remove or disconnect the power source until the access lamp has gone out* (□ 2). If the camera is switched off while data remain in the buffer, the power will not turn off until all images in the buffer have been recorded. If the battery is exhausted while images remain in the buffer, the shutter release will be disabled and the images transferred to the memory card.

## **Continuous Release Mode**

Continuous release mode (□ 1) can not be used with the built-in flash; rotate the mode dial to (□ 13) or turn the flash off (□ 34–36).

## **Buffer Size**

The approximate number of images that can be stored in the memory buffer at current settings is shown in the viewfinder exposure-count display while the shutter-release button is pressed. The illustration shows the display when space remains in the buffer for about 19 pictures.



## **The Information Display**

The release mode can also be selected using the **Release mode** option in the information display (□ 5).





# Self-Timer and Remote Control Modes

The self-timer and optional ML-L3 remote control (☐ 73) allow the photographer to be at a distance from the camera when a photo is taken.

## 1 Mount the camera on a tripod.

Mount the camera on a tripod or place the camera on a stable, level surface.

## 2 Select a release mode.

Select  (self-timer),  2s (delayed remote), or  (quick-response remote) mode (☐ 25; note that if no operations are performed for about a minute after a remote control mode is selected, the camera will automatically return to single frame, continuous, or quiet shutter-release mode).

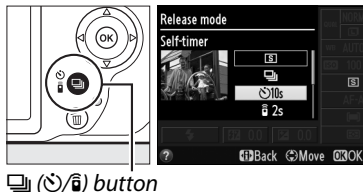

 button

## 3 Frame the photograph.

**Remote control mode:** Check focus by pressing the shutter-release button halfway. No photograph will be taken even if the button is pressed all the way down.

## 4 Take the photograph.

**Self-timer mode:** Press the shutter-release button halfway to focus, and then press the button the rest of the way down. The self-timer lamp will start to flash and a beep will begin to sound. Two seconds before the photo is taken, the lamp will stop flashing and the beeping will become more rapid. The shutter will be released ten seconds after the timer starts.

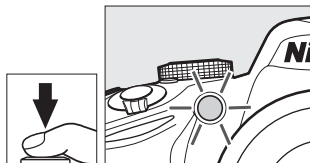

**Remote control mode:** From a distance of 5 m (16 ft) or less, aim the transmitter on the ML-L3 at either of the infrared receivers on the camera (☐ 1, 2) and press the ML-L3 shutter-release button. *In delayed remote mode*, the self-timer lamp will light for about two seconds before the shutter is released. *In quick-response remote mode*, the self-timer lamp will flash after the shutter has been released.

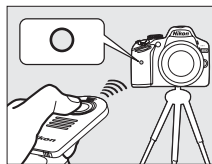

Note that the timer may not start or a photograph may not be taken if the camera is unable to focus or in other situations in which the shutter can not be released. Turning the camera off cancels self-timer and remote control release modes and restores single frame, continuous, or quiet shutter-release mode.

### ✓ Before Using the Remote Control



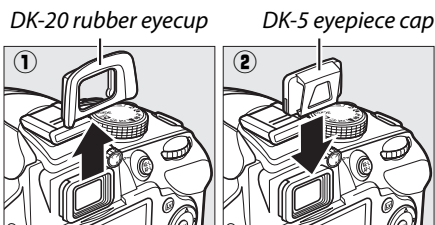

Before using the remote control for the first time, remove the clear plastic battery-insulator sheet.

### ✎ Cover the Viewfinder

When taking photos without your eye to the viewfinder, remove the DK-20 rubber eyecup (①) and insert the supplied DK-5 eyepiece cap as shown (②). This prevents light entering via the viewfinder interfering with exposure. Hold the camera firmly when removing the rubber eyecup.





### ✓ Using the Built-in Flash

Before taking a photograph with the flash in **P**, **S**, **A**, or **M** modes, press the  () button to raise the flash and wait for the  indicator to be displayed in the viewfinder ( 4). Shooting will be interrupted if the flash is raised while a remote control mode is in effect or after the self-timer has started. If the flash is required, the camera will only respond to the ML-L3 shutter-release button once the flash has charged. In auto or scene modes in which the flash pops up automatically, the flash will begin charging when a remote control mode is selected; once the flash is charged, it will automatically pop up and fire when required.

In flash modes that support red-eye reduction, the red-eye reduction lamp will light for about one second before the shutter is released in quick-response remote mode. In delayed remote mode, the self-timer lamp will light for two seconds, followed by the red-eye reduction lamp which lights for one second before the shutter is released.

### ✎ See Also

For information on choosing the duration of the self-timer and the number of shots taken, see the **Self-timer** option in the setup menu ( 55). For information on choosing how long the camera will wait for a signal from the remote, see the **Remote on duration** option in the setup menu ( 55). For information on controlling the beeps that sound when the self-timer and remote control are used, see the **Beep** option in the setup menu ( 55).



# Focus



This section describes the focus options available when photographs are framed in the viewfinder. Focus can be adjusted automatically or manually (see “Focus Mode,” below), and the focus point for automatic or manual focus can be selected using the multi selector.

## Focus Mode

Choose from the following focus modes. Note that **AF-S** and **AF-C** are available only in modes **P**, **S**, **A**, and **M**.

Option	Description
<b>AF-A</b> <b>Auto-servo AF</b>	Camera automatically selects single-servo autofocus if subject is stationary, continuous-servo autofocus if subject is moving. Shutter can only be released if camera is able to focus.
<b>AF-S</b> <b>Single-servo AF</b>	For stationary subjects. Focus locks when shutter-release button is pressed halfway. Shutter can only be released if camera is able to focus.
<b>AF-C</b> <b>Continuous-servo AF</b>	For moving subjects. Camera focuses continuously while shutter-release button is pressed halfway. Shutter can only be released if camera is able to focus.
<b>MF</b> <b>Manual focus</b>	Focus using the lens focus ring.

### 1 Place the cursor in the information display.

If shooting information is not displayed in the monitor, press the  button. Press the  button again to place the cursor in the information display.

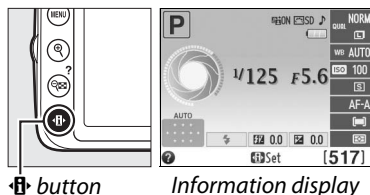

### 2 Display focus-mode options.

Highlight the current focus mode in the information display and press .

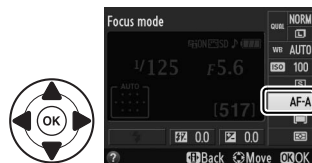

### 3 Choose a focus mode.

Highlight a focus mode and press . To return to shooting mode, press the shutter-release button halfway.



### **Predictive Focus Tracking**

In **AF-C** mode or when continuous-servo autofocus is selected in **AF-A** mode, the camera will initiate predictive focus tracking if the subject moves toward the camera while the shutter-release button is pressed halfway. This allows the camera to track focus while attempting to predict where the subject will be when the shutter is released.

### **Continuous-servo Autofocus**

In **AF-C** mode or when continuous-servo autofocus is selected in **AF-A** mode, the camera gives higher priority to focus response (has a wider focus range) than in **AF-S** mode, and the shutter may be released before the in-focus indicator is displayed.

### **Getting Good Results with Autofocus**

Autofocus does not perform well under the conditions listed below. The shutter release may be disabled if the camera is unable to focus under these conditions, or the in-focus indicator (●) may be displayed and the camera may sound a beep, allowing the shutter to be released even when the subject is not in focus. In these cases, focus manually or use focus lock to focus on another subject at the same distance and then recompose the photograph.

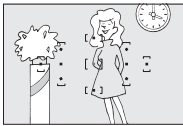

*There is little or no contrast between the subject and the background.*

**Example:** Subject is the same color as the background.

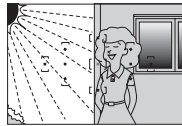

*The focus point contains areas of sharply contrasting brightness.*

**Example:** Subject is half in the shade.



*The focus point contains objects at different distances from the camera.*

**Example:** Subject is inside a cage.



*Background objects appear larger than the subject.*

**Example:** A building is in the frame behind the subject.

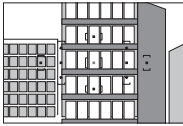

*The subject is dominated by regular geometric patterns.*

**Example:** Blinds or a row of windows in a skyscraper.

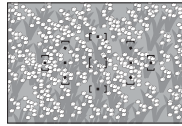

*The subject contains many fine details.*

**Example:** A field of flowers or other subjects that are small or lack variation in brightness.



# AF-Area Mode

Choose how the focus point for autofocus is selected. Note that [⊕] (**Dynamic-area AF**) and [3D] (**3D-tracking (11 points)**) are not available when **AF-S** is selected for focus mode.

Option	Description
[⊕] <b>Single-point AF</b>	User selects focus point using multi selector; camera focuses on subject in selected focus point only. Use with stationary subjects.
[⊕] <b>Dynamic-area AF</b>	<b>In AF-A and AF-C focus modes</b> (☞ 29), user selects focus point using multi selector, but camera will focus based on information from surrounding focus points if subject briefly leaves selected point. Use with erratically moving subjects.
[3D] <b>3D-tracking (11 points)</b>	<b>In AF-A and AF-C focus modes</b> (☞ 29), user selects focus point using multi selector. If subject moves after camera has focused, camera uses 3D-tracking to select new focus point and keep focus locked on original subject while shutter-release button is pressed halfway. If subject leaves viewfinder, remove your finger from shutter-release button and recompose photograph with subject in selected focus point.
[☐] <b>Auto-area AF</b>	Camera automatically detects subject and selects focus point.

## 1 Place the cursor in the information display.

If shooting information is not displayed in the monitor, press the **INFO** button. Press the **INFO** button again to place the cursor in the information display.

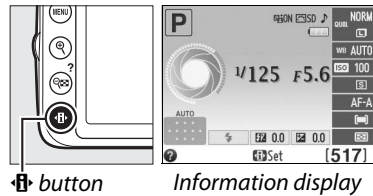

## 2 Display AF-area mode options.

Highlight the current AF-area mode in the information display and press **OK**.

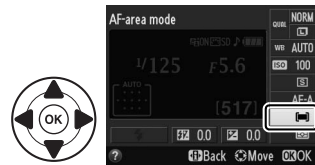

## 3 Choose an AF-area mode.

Highlight one of the following options and press **OK**. To return to shooting mode, press the shutter-release button halfway.

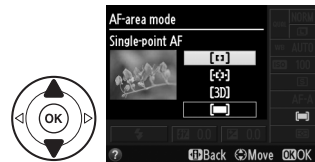



# Image Quality and Size

Together, image quality and size determine how much space each photograph occupies on the memory card. Larger, higher quality images can be printed at larger sizes but also require more memory, meaning that fewer such images can be stored on the memory card.

## Image Quality

Choose a file format and compression ratio (image quality).

Option	File type	Description
NEF (RAW) + JPEG fine	NEF/ JPEG	Two images are recorded: one NEF (RAW) image and one fine-quality JPEG image.
NEF (RAW)	NEF	Raw 12-bit data from the image sensor are saved directly to the memory card. Settings such as white balance and contrast can be adjusted after shooting.
JPEG fine		Record JPEG images at a compression ratio of roughly 1 : 4 (fine quality).
JPEG normal	JPEG	Record JPEG images at a compression ratio of roughly 1 : 8 (normal quality).
JPEG basic		Record JPEG images at a compression ratio of roughly 1 : 16 (basic quality).

### 1 Place the cursor in the information display.

If shooting information is not displayed in the monitor, press the **INFO** button. Press the **INFO** button again to place the cursor in the information display.

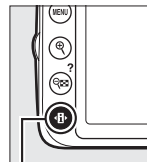

INFO button



Information display

### 2 Display image quality options.

Highlight the current image quality in the information display and press **OK**.





### 3 Choose a file type.

Highlight an option and press **OK**. To return to shooting mode, press the shutter-release button halfway.





# Image Size

Image size is measured in pixels. Choose from the following options:

Image size	Size (pixels)	Print size (cm/in.)*
 Large	6,016 × 4,000	50.9 × 33.9/20.1 × 13.3
 Medium	4,512 × 3,000	38.2 × 25.4/15 × 10
 Small	3,008 × 2,000	25.5 × 16.9/10 × 6.7

\* Approximate size when printed at 300 dpi. Print size in inches equals image size in pixels divided by printer resolution in dots per inch (dpi); 1 inch = approximately 2.54 cm.

## 1 Place the cursor in the information display.

If shooting information is not displayed in the monitor, press the  button. Press the  button again to place the cursor in the information display.

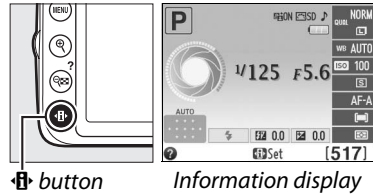

 button

Information display

## 2 Display image size options.

Highlight the current image size in the information display and press .



## 3 Choose an image size.

Highlight an option and press . To return to shooting mode, press the shutter-release button halfway.

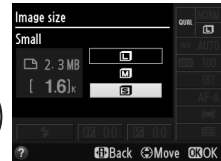

### File Names

Photographs are stored as image files with names of the form "DSC\_nnnn.xxx," where *nnnn* is a four-digit number between 0001 and 9999 assigned automatically in ascending order by the camera, and *xxx* is one of the following three letter extensions: "NEF" for NEF images, "JPG" for JPEG images, or "MOV" for movies. The NEF and JPEG files recorded at a setting of **NEF (RAW) + JPEG fine** have the same file names but different extensions.

# Using the Built-in Flash

The camera supports a variety of flash modes for photographing poorly lit or backlit subjects.

## ■ ■ Using the Built-in Flash: , , , , and Modes

### 1 Choose a flash mode ( 35).

### 2 Take pictures.

The flash will pop up as required when the shutter-release button is pressed halfway, and fire when a photograph is taken. *If the flash does not pop up automatically, DO NOT attempt to raise it by hand. Failure to observe this precaution could damage the flash.*

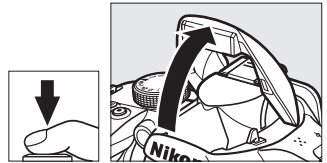

## ■ ■ Using the Built-in Flash: P, S, A, and M Modes

### 1 Raise the flash.



Press the  () button to raise the flash.

### 2 Choose a flash mode ( 35).

### 3 Take pictures.

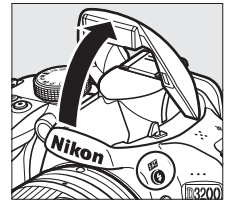
The flash will fire whenever a picture is taken.



 () button





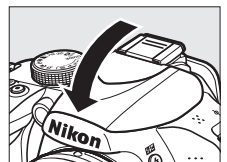



















### Lowering the Built-in Flash

To save power when the flash is not in use, press it gently downward until the latch clicks into place.





# Flash Mode

The flash modes available vary with shooting mode:

AUTO,  ,  ,  , 			
 AUTO	Auto	  AUTO SLOW	Auto slow sync + red-eye
  AUTO	Auto + red-eye reduction	 AUTO SLOW	Auto slow sync
 (off)	Flash off	 (off)	Flash off
P, A		S, M	
	Fill flash		Fill flash
 	Red-eye reduction	 	Red-eye reduction
  SLOW	Slow sync + red-eye	 REAR	Rear-curtain sync
 SLOW	Slow sync		
 REAR *	Rear-curtain + slow sync		

\* SLOW appears in information display when setting is complete.

## 1 Place the cursor in the information display.

If shooting information is not displayed in the monitor, press the  button. Press the  button again to place the cursor in the information display.

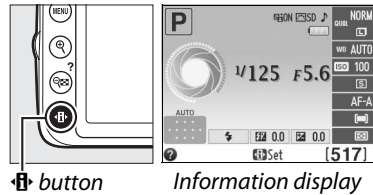

## 2 Display flash mode options.

Highlight the current flash mode in the information display and press .

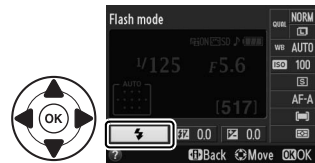

## 3 Choose a flash mode.

Highlight a mode and press . To return to shooting mode, press the shutter-release button halfway.

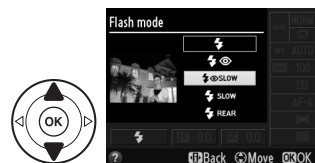

## Flash Modes

The flash modes listed on the previous page may combine one or more of the following settings, as shown by the flash mode icon:

- **AUTO (auto flash):** When lighting is poor or subject is back lit, flash pops up automatically when shutter-release button is pressed halfway and fires as required.
- **👁 (red-eye reduction):** Use for portraits. Red-eye reduction lamp lights before flash fires, reducing “red-eye.”
- **🔇 (off):** Flash does not fire even when lighting is poor or subject is back-lit.
- **SLOW (slow sync):** Shutter speed slows automatically to capture background lighting at night or under low light. Use to include background lighting in portraits.
- **REAR (rear-curtain sync):** Flash fires just before shutter closes, creating a stream of light behind moving light sources (below at right). If this icon is not displayed, flash will fire as the shutter opens (front-curtain sync; the effect this produces with moving light sources is shown below at left).





Front-curtain sync



Rear-curtain sync

## Choosing a Flash Mode

The flash mode can also be selected by pressing the  button and rotating the command dial (in P, S, A, and M modes, raise the flash before using the  button to choose the flash mode).

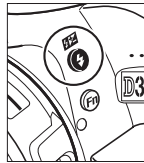

 button



Command dial

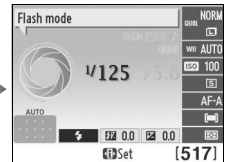

Information display





## The Built-in Flash

For information on the lenses that can be used with the built-in flash, see the *Reference Manual*. Remove lens hoods to prevent shadows. The flash has a minimum range of 0.6 m (2 ft) and can not be used in the macro range of zoom lenses with a macro function.

The shutter release may be briefly disabled to protect the flash after it has been used for several consecutive shots. The flash can be used again after a short pause.

## Shutter Speeds Available with the Built-in Flash

Shutter speed is restricted to the following ranges when the built-in flash is used:

Mode	Shutter speed	Mode	Shutter speed
AUTO,  ,  , P, A	$1/200$ – $1/60$ s	S	$1/200$ –30 s
	$1/200$ – $1/30$ s	M	$1/200$ –30 s, Bulb
	$1/200$ –1 s		

Shutter speeds as slow as 30 s are available in slow sync, rear-curtain + slow sync, and slow sync + red-eye reduction modes.





# ISO Sensitivity

“ISO sensitivity” is the digital equivalent of film speed. The higher the ISO sensitivity, the less light needed to make an exposure, allowing higher shutter speeds or smaller apertures, but the more likely the image is to be affected by noise (randomly-spaced bright pixels, fog, or lines; noise is particularly likely at a setting of Hi 1, which is equivalent to ISO 12800). Choosing **Auto** allows the camera to set ISO sensitivity automatically in response to lighting conditions.

Mode	ISO sensitivity
AUTO 	Auto
P, S, A, M	100–6400 in steps of 1 EV; Hi 1
Other shooting modes	Auto; 100–6400 in steps of 1 EV; Hi 1

## 1 Place the cursor in the information display.

If shooting information is not displayed in the monitor, press the  button. Press the  button again to place the cursor in the information display.

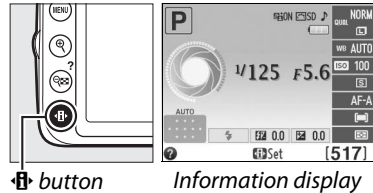

## 2 Display ISO sensitivity options.

Highlight the current ISO sensitivity in the information display and press .



## 3 Choose an ISO sensitivity.

Highlight an option and press . To return to shooting mode, press the shutter-release button halfway.

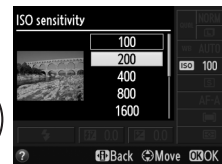



# P, S, A, and M Modes

P, S, A, and M modes offer different degrees of control over shutter speed and aperture. See the *Reference Manual* for more information on each mode.



## Mode P (Programmed Auto)

In this mode, the camera automatically adjusts shutter speed and aperture for optimal exposure in most situations. This mode is recommended for snapshots and other situations in which you want to leave the camera in charge of shutter speed and aperture.

User can rotate command dial to choose from different combinations of shutter speed and aperture that will produce optimal exposure.



Command dial

### Shutter Speed and Aperture

The same exposure can be achieved with different combinations of shutter speed and aperture. Fast shutter speeds and large apertures freeze moving objects and soften background details, while slow shutter speeds and small apertures blur moving objects and bring out background details.



Fast shutter speed  
( $1/1,600$  s)

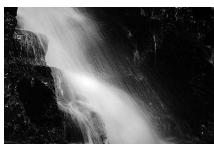

Slow shutter speed  
(1 s)



Large aperture (f/5.6)



Small aperture (f/22)

(Remember, the higher the *f*-number, the smaller the aperture.)



## Mode S (Shutter-Priority Auto)

In shutter-priority auto, you choose the shutter speed while the camera automatically selects the aperture that will produce the optimal exposure. Use slow shutter speeds to suggest motion by blurring moving subjects, fast shutter speeds to “freeze” motion.

To choose a shutter speed, rotate the command dial.

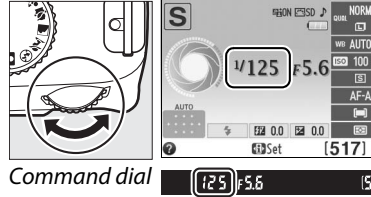

## Mode A (Aperture-Priority Auto)

In aperture-priority auto, you choose the aperture while the camera automatically selects the shutter speed that will produce the optimal exposure. Large apertures (low f-numbers) reduce depth of field, blurring objects behind and in front of the main subject. Small apertures (high f-numbers) increase depth of field, bringing out details in the background and foreground. Short field depths are generally used in portraits to blur background details, long field depths in landscape photographs to bring the foreground and background into focus.

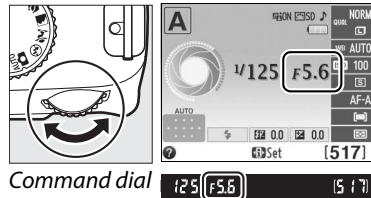

To choose an aperture, rotate the command dial (the maximum and minimum values for aperture vary with the lens used).





# Mode M (Manual)

In manual exposure mode, you control both shutter speed and aperture. Shutter speeds of “Bulb” and “Time” are available for long time-exposures of fireworks or the night sky.

Shutter speed is set by rotating the command dial,  button aperture by pressing  and rotating the command dial (the maximum and minimum values for aperture vary with the lens used).

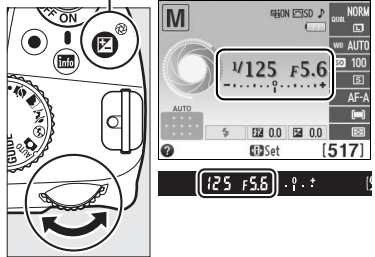

Command dial



## The Exposure Indicator

If a CPU lens is attached and a shutter speed other than “Bulb” or “Time” is selected, the exposure indicator in the viewfinder and information display shows whether the photograph would be under- or over-exposed at current settings (the illustrations below show the display in the viewfinder). The displays will flash if the limits of the exposure metering system are exceeded.

Optimal exposure	Underexposed by 1/3 EV	Overexposed by over 2 EV
- . 0 . +	- . 0 . +	- . 0 +      ▶

# Live View

## Framing Photographs in the Monitor

Follow the steps below to take photographs in live view.

### 1 Press the **Lv** button.

The mirror will be raised and the view through the lens will be displayed in the camera monitor. The subject will no longer be visible in the viewfinder.

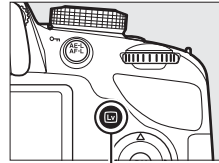

**Lv** button

### 2 Position the focus point.

Position the focus point over your subject as described on page 44.



Focus point

### 3 Focus.

Press the shutter-release button halfway. The focus point will flash green while the camera focuses. If the camera is able to focus, the focus point will be displayed in green; if the camera is unable to focus, the focus point will flash red (note that pictures can be taken even when the focus point flashes red; check focus in the monitor before shooting). Except in **AUTO** and **☺** modes, exposure can be locked by pressing the **AE-L/AF-L** (**☺**) button.



### 4 Take the picture.

Press the shutter-release button the rest of the way down. The monitor turns off and the memory card access lamp lights during recording. *Do not remove the battery or memory card or unplug the optional AC adapter until recording is complete.* When shooting is complete, the photograph will be displayed in the monitor for a few seconds or until the shutter-release button is pressed halfway. The camera will then return to live view mode. To exit, press the **Lv** button.

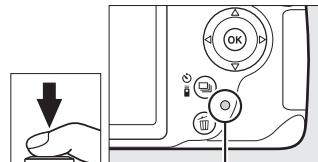

Memory card access lamp

# Focusing in Live View

Follow the steps below to choose focus and AF-area modes and position the focus point.

## ■ ■ Choosing a Focus Mode

The following focus modes are available in live view:

Option	Description
<b>AF-S Single-servo AF</b>	For stationary subjects. Focus locks when shutter-release button is pressed halfway.
<b>AF-F Full-time-servo AF</b>	For moving subjects. Camera focuses continuously until shutter-release button is pressed halfway. Focus locks when shutter-release button is pressed halfway.
<b>MF Manual focus</b>	Focus manually.

### 1 Place the cursor in the information display.

Press the  button to place the cursor in the information display.





### 2 Display focus options.

Highlight the current focus mode in the information display and press .









### 3 Choose a focus option.

Highlight an option and press . To return to live view, press .



## ■ ■ ■ Choosing an AF-Area Mode

In modes other than  and , the following AF-area modes can be selected in live view:

Mode	Description
 <b>Face-priority AF</b>	The camera automatically detects and focuses on portrait subjects. Use for portraits.
 <b>Wide-area AF</b>	Use for hand-held shots of landscapes and other non-portrait subjects. Use the multi selector to select the focus point.
 <b>Normal-area AF</b>	Use for pin-point focus on a selected spot in the frame. A tripod is recommended.
 <b>Subject-tracking AF</b>	Track a selected subject as it moves through the frame.

### 1 Place the cursor in the information display.

Press the  button to place the cursor in the information display.





 button

### 2 Display AF-area modes.

Highlight the current AF-area mode in the information display and press .



### 3 Choose an AF-area mode.

Highlight an option and press . To return to live view, press .



## ■ Choosing the Focus Point

The method for selecting the focus point for autofocus varies with the option selected for AF-area mode (□ 43).

**☺ (face-priority AF):** A double yellow border will be displayed when the camera detects a portrait subject (if multiple faces, up to a maximum of 35, are detected, the camera will focus on the closest subject; to choose a different subject, use the multi selector). If the camera can no longer detect the subject (because, for example, the subject has turned to face away from the camera), the border will no longer be displayed.

**Wide- and normal-area AF:** Use the multi selector to move the focus point to any point in the frame, or press **OK** to position the focus point in the center of the frame.

**☺ (subject-tracking AF):** Position the focus point over your subject and press **OK**. The focus point will track the selected subject as it moves through the frame. To end tracking, press **OK**.



*Focus point*



*Focus point*



*Focus point*

### ☑ Subject Tracking

The camera may be unable to track subjects if they move quickly, leave the frame or are obscured by other objects, change visibly in size, color, or brightness, or are too small, too large, too bright, too dark, or similar in color or brightness to the background.

## ■ The Live View Display

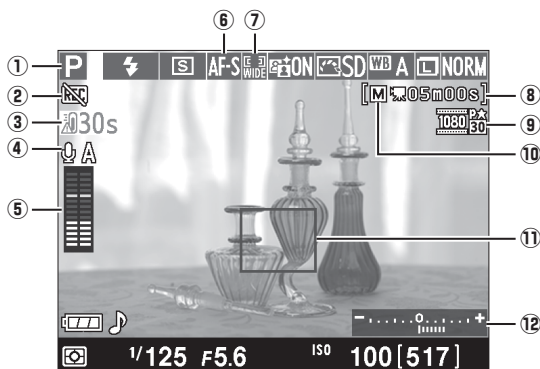

Item	Description	📖
① Shooting mode	The mode currently selected with the mode dial.	13, 17, 38
② “No movie” icon	Indicates that movies can not be recorded.	49
③ Time remaining	The amount of time remaining before live view ends automatically. Displayed if shooting will end in 30 s or less.	47, 52
④ Microphone sensitivity	Microphone sensitivity for movie recording.	51
⑤ Sound level	Sound level for audio recording. Displayed in red if level is too high; adjust microphone sensitivity accordingly. Left (L) and right (R) channel indicators appear when optional ME-1 or other stereo microphone is used.	51
⑥ Focus mode	The current focus mode.	42
⑦ AF-area mode	The current AF-area mode.	43
⑧ Time remaining (movie mode)	The recording time remaining in movie mode.	49
⑨ Movie frame size	The frame size of movies recorded in movie mode.	51
⑩ Manual movie settings indicator	Displayed when <b>On</b> is selected for <b>Manual movie settings</b> in mode <b>M</b> .	51
⑪ Focus point	The current focus point. The display varies with the option selected for AF-area mode (📄 43).	44
⑫ Exposure indicator	Indicates whether the photograph would be under- or over-exposed at current settings (mode <b>M</b> only).	40

## Live View/Movie Recording Display Options

Press the **Info** button to cycle through display options as shown below.

Circled areas indicate edges of movie frame crop

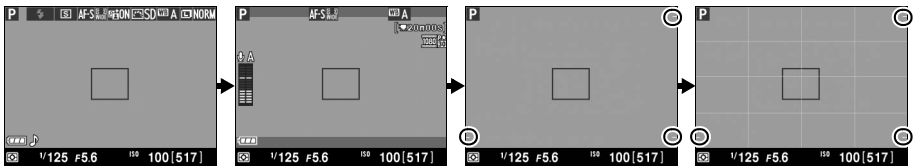

**Show photo indicators**

**Show movie indicators (49)\***







**Hide indicators\***

**Framing grid\***

\* A crop showing the area recorded is displayed during movie recording when frame sizes other than  $640 \times 424$  are selected for **Movie settings > Frame size/frame rate** (45) in the shooting menu (the area outside the movie frame crop is grayed out when movie indicators are displayed).

## Automatic Scene Selection (Scene Auto Selector)

If live view is selected in **AUTO** or **AF-ON** mode, the camera will automatically analyze the subject and select the appropriate shooting mode when autofocus is enabled. The selected mode is shown in the monitor (45).

	<b>Portrait</b>	Human portrait subjects
	<b>Landscape</b>	Landscapes and cityscapes
	<b>Close up</b>	Subjects close to the camera
	<b>Night portrait</b>	Portrait subjects framed against a dark background
	<b>Auto</b>	Subjects suited to <b>AUTO</b> or <b>AF-ON</b> mode or that do not fall into the categories listed above
	<b>Auto (flash off)</b>	

## Exposure

Depending on the scene, exposure may differ from that which would be obtained when live view is not used. Metering in live view is adjusted to suit the live view display, producing photographs with exposure close to what is seen in the monitor. In **P**, **S** and **A** modes, exposure can be adjusted by  $\pm 5$  EV in increments of  $1/3$  EV. Note that the effects of values over  $+3$  EV or under  $-3$  EV can not be previewed in the monitor.

### ✓ Shooting in Live View Mode

To prevent light entering via the viewfinder from interfering with exposure, remove the rubber eyecup and cover the viewfinder with the supplied DK-5 eyepiece cap before shooting (☐ 28).

Although they will not appear in the final picture, distortion may be visible in the monitor if the camera is panned horizontally or an object moves at high speed through frame. Bright light sources may leave after-images in the monitor when the camera is panned. Bright spots may also appear. Flicker and banding visible in the monitor under fluorescent, mercury vapor, or sodium lamps can be reduced using **Flicker reduction** (☐ 55), although they may still be visible in the final photograph at some shutter speeds. When shooting in live view mode, avoid pointing the camera at the sun or other strong light sources. Failure to observe this precaution could result in damage to the camera's internal circuitry.

Live view ends automatically if the lens is removed, the mode dial is rotated to **GUIDE**, or the mode dial is rotated from **GUIDE** to another setting.

Live view may end automatically to prevent damage to the camera's internal circuits; exit live view when the camera is not in use. Note that the temperature of the camera's internal circuits may rise and noise (bright spots, randomly-spaced bright pixels, or fog) may be displayed in the following instances (the camera may also become noticeably warm, but this does not indicate a malfunction):

- The ambient temperature is high
- The camera has been used for extended periods in live view or to record movies
- The camera has been used in continuous release mode for extended periods

If live view does not start when you press the  button, wait for the internal circuits to cool and then try again.

### ✓ The Count Down Display

A count down will be displayed 30 s before live view ends automatically (☐ 45; the timer turns red 5 s before the auto off timer expires or if live view is about to end to protect the internal circuits). Depending on shooting conditions, the timer may appear immediately when live view is selected. Note that although the count down does not appear in the information display or during playback, live view will still end automatically when the timer expires.



### **Using Autofocus in Live View**

Autofocus is slower in live view and the monitor may brighten or darken while the camera focuses. The camera may be unable to focus in the following situations:

- The subject contains lines parallel to the long edge of the frame
- The subject lacks contrast
- The subject in the focus point contains areas of sharply contrasting brightness, or the subject is lit by spot lighting or by a neon sign or other light source that changes in brightness
- Flicker or banding appears under fluorescent, mercury-vapor, sodium-vapor, or similar lighting
- A cross (star) filter or other special filter is used
- The subject appears smaller than the focus point
- The subject is dominated by regular geometric patterns (e.g., blinds or a row of windows in a skyscraper)
- The subject is moving

Note that the focus point may sometimes be displayed in green when the camera is unable to focus.

# Recording and Viewing Movies

## Recording Movies

Movies can be recorded in live view mode.

### 1 Press the button.

The mirror is raised and the view through the lens is displayed in the monitor instead of the viewfinder.

#### **The Icon**

A  icon (□ 45) indicates that movies can not be recorded.

#### **Before Recording**

Set aperture before recording in mode **A** or **M**.

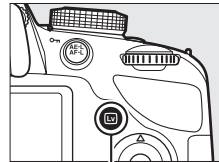



 button

### 2 Focus.

Frame the opening shot and focus as described in Steps 2 and 3 of “Framing Photographs in the Monitor” (□ 41; see also “Focusing in Live View” on pages □ 42–44). Note that the number of subjects that can be detected in face-priority AF drops during movie recording.



### 3 Start recording.

Press the movie-record button to start recording. A recording indicator and the time available are displayed in the monitor. Except in  and  modes, exposure can be locked by pressing the  button or (in modes **P**, **S**, and **A**) altered by up to  $\pm 3$  EV in steps of  $1/3$  EV using exposure compensation (note that depending on the brightness of the subject, changes to exposure may have no visible effect).

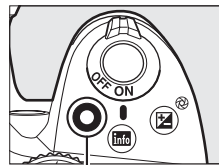

Movie record button  
Recording indicator



Time remaining

## 4 End recording.

Press the movie-record button again to end recording. Recording will end automatically when the maximum length is reached, the memory card is full, another mode is selected, or the lens is removed.

### Taking Photographs During Movie Recording

To end movie recording, take a photograph, and exit to live view, press the shutter-release button all the way down and hold it in this position until the shutter is released.

### Maximum Length

Each movie file can be up to 4 GB in size and 20 minutes long; note that depending on memory card write speed, shooting may end before this length is reached (□ 64).

### Recording Movies

Flicker, banding, or distortion may be visible in the monitor and in the final movie under fluorescent, mercury vapor, or sodium lamps or if the camera is panned horizontally or an object moves at high speed through frame (flicker and banding can be reduced using **Flicker reduction**; □ 55). Bright light sources may leave after-images when the camera is panned. Jagged edges, color fringing, moiré, and bright spots may also appear. Bright bands may appear in some areas of the frame if the subject is briefly illuminated by a strobe or other bright, momentary light source. When recording movies, avoid pointing the camera at the sun or other strong light sources. Failure to observe this precaution could result in damage to the camera's internal circuitry.

The camera can record both video and sound; do not cover the microphone on the front of the camera during recording. Note that the built-in microphone may record lens noise during autofocus and vibration reduction.

Flash lighting can not be used during movie recording.

Live view may end automatically to prevent damage to the camera's internal circuits; exit live view when the camera is not in use. Note that the temperature of the camera's internal circuits may rise and noise (bright spots, randomly-spaced bright pixels, or fog) may be displayed in the following instances (the camera may also become noticeably warm, but this does not indicate a malfunction):

- The ambient temperature is high
- The camera has been used for extended periods in live view or to record movies
- The camera has been used in continuous release mode for extended periods

If live view does not start when you press the  button, wait for the internal circuits to cool and then try again.

Matrix metering is used regardless of the metering method selected. Shutter speed and ISO sensitivity are adjusted automatically unless **On** is selected for **Manual movie settings** (□ 51) and the camera is in mode **M**.

### See Also







For information on the indicators displayed in live view, see page 45. For information on choosing focus and AF-area modes, see page 42 and 43. See page 48 for information on focusing in live view.



# Movie Settings

Use the **Movie settings** option in the shooting menu to adjust the following settings.

- **Frame size/frame rate, Movie quality:** Choose from the following options. The frame rate depends on the option currently selected for **Video mode** in the setup menu (□ 55):

	Frame size/frame rate		Movie quality	Maximum length
	Frame size (pixels)	Frame rate <sup>1</sup>	Maximum bit rate (Mbps) (★ high quality/Normal)	
	1920 × 1080	30p <sup>2</sup>	24/12	20 min.
		25p <sup>3</sup>		
		24p		
	1280 × 720	60p <sup>2</sup>	5/3	
		50p <sup>3</sup>		
	640 × 424	30p <sup>2</sup>	5/3	
		25p <sup>3</sup>		

1 Listed value. Actual frame rates for 60p, 50p, 30p, 25p, and 24p are 59.94, 50, 29.97, 25, and 23.976 fps respectively.

2 Available when **NTSC** is selected for **Video mode**.

3 Available when **PAL** is selected for **Video mode**.

- **Microphone:** Turn the built-in or optional ME-1 stereo microphones on or off or adjust microphone sensitivity. Choose **Auto sensitivity** to adjust sensitivity automatically, **Microphone off** to turn sound recording off; to select microphone sensitivity manually, select **Manual sensitivity** and choose a sensitivity.
- **Manual movie settings:** Choose **On** to allow manual adjustments to shutter speed and ISO sensitivity when the camera is in mode **M**. Shutter speed can be set to values as fast as  $\frac{1}{4,000}$  s; the slowest speed available varies with the frame rate:  $\frac{1}{30}$  s for frame rates of 24p, 25p, and 30p,  $\frac{1}{50}$  s for 50p, and  $\frac{1}{60}$  s for 60p. ISO sensitivity can be set to values between ISO 200 and Hi 1 (□ 37). If shutter speed and ISO sensitivity are not in these ranges when live view starts, they will automatically be set to supported values, and remain at these values when live view ends. Note that ISO sensitivity is fixed at the value selected; the camera does not adjust ISO sensitivity automatically when **On** is selected for **ISO sensitivity settings > Auto ISO sensitivity control** in the shooting menu (□ 55).

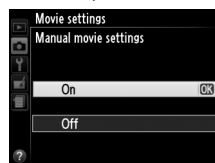

## 1 Select Movie settings.

Press the **MENU** button to display the menus. Highlight **Movie settings** in the shooting menu and press **▶**.

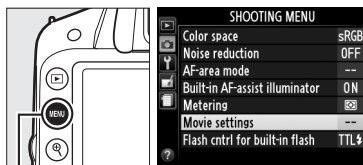

MENU button

## 2 Choose movie options.

Highlight the desired item and press **▶**, then highlight an option and press **OK**.

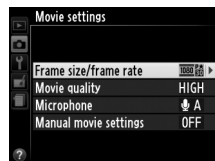

### ✓ Using an External Microphone



The optional ME-1 stereo microphone (☞ 64) can be used to record sound in stereo or to reduce noise caused by lens vibration being recorded during autofocus.

### ✓ The Count-Down Display

A count down will be displayed 30 s before live view ends automatically (☞ 45). Depending on shooting conditions, the timer may appear immediately when movie recording begins. Note that regardless of the amount of recording time available, live view will still end automatically when the timer expires. Wait for the internal circuits to cool before resuming movie recording.







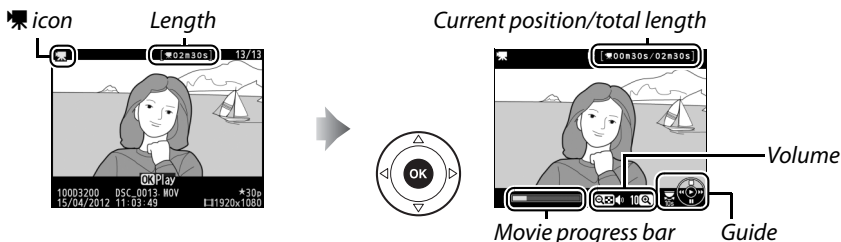











# Viewing Movies

Movies are indicated by a  icon in full-frame playback ( 19). Press  to start playback.



The following operations can be performed:

To	Use	Description
Pause		Pause playback.
Play		Resume playback when movie is paused or during rewind/advance.
Advance/ rewind		Speed increases with each press, from 2× to 4× to 8× to 16×; keep pressed to skip to beginning or end of movie (first frame is indicated by  in top right corner of monitor, last frame by  ). If playback is paused, movie rewinds or advances one frame at a time; hold for continuous rewind or advance.
Skip 10 s		Rotate the command dial to skip ahead or back 10 s.
Adjust volume	 /  (?)	Press  to increase volume,  (?) to decrease.
Edit movie		To edit movie, press  while movie is paused.
Return to full-frame playback	 / 	Press  or  to exit to full-frame playback.
Exit to shooting mode		Press shutter-release button halfway. Monitor will turn off; photographs can be taken immediately.

## The Icon

 is displayed in full-frame and movie playback if the movie was recorded without sound.



# Menu Guide

Most shooting, playback, and setup options can be accessed from the camera menu. To view the menu, press the **MENU** button.

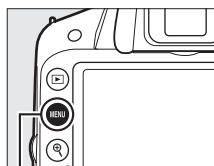

MENU button

## Tabs

Choose from the following menus:

- : Playback
- : Shooting
- : Setup
- : Retouch
- : Recent settings

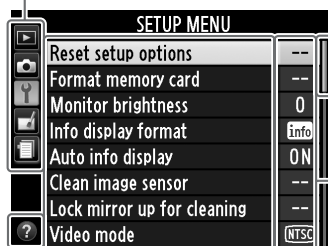

Slider shows position in current menu.

Current settings are shown by icons.

## Menu options

Options in current menu.



If a icon is displayed at the bottom left corner of the monitor, help can be displayed by pressing the (). A description of the currently selected option or menu will be displayed while the button is pressed. Press or to scroll through the display.

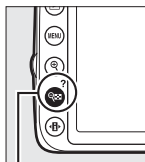

() button

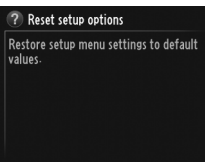

## Guide Mode

To display the on-screen guide, rotate the mode dial to **GUIDE** ( 21).

# Menu Guide

## ■▶ Playback Menu: Managing Images

Delete	Image review	DPOF print order
Playback folder	Rotate tall	
Playback display options	Slide show	

## ■📷 Shooting Menu: Shooting Options

Reset shooting menu	ISO sensitivity settings	AF-area mode
Set Picture Control	Active D-Lighting	Built-in AF-assist illuminator
Image quality	Auto distortion control	Metering
Image size	Color space	Movie settings
White balance	Noise reduction	Flash ctrl for built-in flash

## ■🔧 Setup Menu: Camera Setup

Reset setup options	Time zone and date	File number sequence
Format memory card	Language	Buttons
Monitor brightness	Image comment	Slot empty release lock
Info display format	Auto image rotation	Print date
Auto info display	Image Dust Off ref photo	Storage folder
Clean image sensor	Auto off timers	GPS
Lock mirror up for cleaning	Self-timer	Eye-Fi upload *
Video mode	Remote on duration	Firmware version
HDMI	Beep	
Flicker reduction	Rangefinder	

\* Only available when compatible Eye-Fi memory card is inserted.

## ■🔪 Retouch Menu: Creating Retouched Copies

D-Lighting	NEF (RAW) processing	Color sketch
Red-eye correction	Resize	Perspective control
Trim	Quick retouch	Miniature effect
Monochrome	Straighten	Selective color
Filter effects	Distortion control	Edit movie
Color balance	Fisheye	
Image overlay	Color outline	

## ■📄 Recent Settings

The recent settings menu lists the twenty most recently used settings.

### 🔪 For More Information

Information on individual menu options is available using the camera's on-board help (🗨 54).



# Using Camera Menus

The multi selector and **OK** button are used to navigate the camera menus.

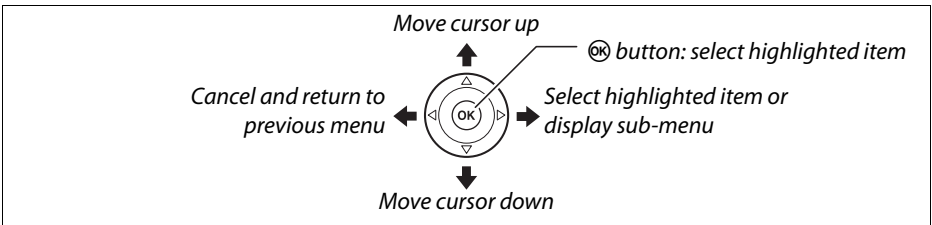

Follow the steps below to navigate the menus.

## 1 Display the menus.

Press the **MENU** button to display the menus.

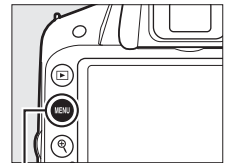

MENU button

## 2 Highlight the icon for the current menu.

Press **◀** to highlight the icon for the current menu.

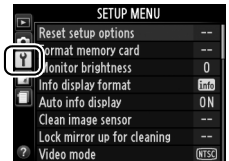

## 3 Select a menu.

Press **▲** or **▼** to select the desired menu.

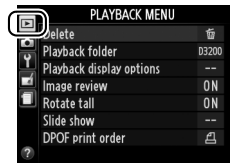
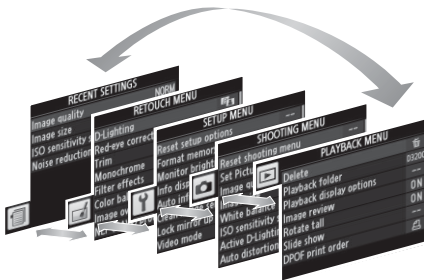

#### 4 Position the cursor in the selected menu.

Press **▶** to position the cursor in the selected menu.

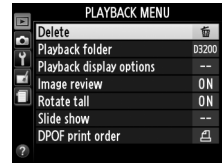

#### 5 Highlight a menu item.

Press **▲** or **▼** to highlight a menu item.

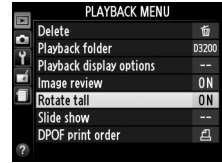

#### 6 Display options.

Press **▶** to display options for the selected menu item.

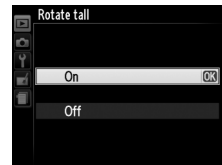

#### 7 Highlight an option.

Press **▲** or **▼** to highlight an option.

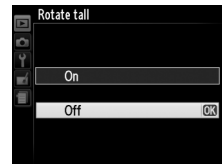

#### 8 Select the highlighted item.

Press **OK** to select the highlighted item. To exit without making a selection, press the **MENU** button.



Note the following:

- Menu items that are displayed in gray are not currently available.
- While pressing **▶** generally has the same effect as pressing **OK**, there are some cases in which selection can only be made by pressing **OK**.
- To exit the menus and return to shooting mode, press the shutter-release button halfway (☞ 16).

# ViewNX 2

## Installing ViewNX 2

Install the supplied software to display and edit photographs and movies that have been copied to your computer. Before installing ViewNX 2, confirm that your computer meets the system requirements on page 59.



### 1 Start the computer and insert the installer CD.

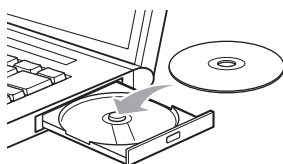

#### Windows



#### Mac OS



Double-click icon on desktop



Double-click **Welcome** icon

### 2 Select a language.

If the desired language is not available, click **Region Selection** to choose a different region and then choose the desired language (region selection is not available in the European release).

#### ① Select region (if required)

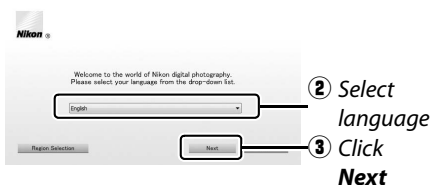

② Select language  
③ Click **Next**

### 3 Start the installer.

Click **Install** and follow the on-screen instructions.



#### Installation Guide

For help installing ViewNX 2, click Installation Guide in Step 3.



Click **Install**

## 4 Exit the installer.

### Windows



Click **Yes**

### Mac OS



Click **OK**

The following software is installed:

- ViewNX 2
- Apple QuickTime (Windows only)

## 5 Remove the installer CD from the CD-ROM drive.

### System Requirements

	Windows	Mac OS
CPU	<ul style="list-style-type: none"> <li>• <b>Photos/JPEG movies:</b> Intel Celeron, Pentium 4, or Core series, 1.6 GHz or better</li> <li>• <b>H.264 movies (playback):</b> 3.0 GHz or better Pentium D; Intel Core i5 or better recommended when viewing movies with a frame size of 1280×720 or more at a frame rate of 30 fps or above or movies with a frame size of 1920×1080 or more</li> <li>• <b>H.264 movies (editing):</b> 2.6 GHz or better Core 2 Duo</li> </ul>	<ul style="list-style-type: none"> <li>• <b>Photos/JPEG movies:</b> PowerPC G4 (1 GHz or better), G5, Intel Core series, or Xeon series</li> <li>• <b>H.264 movies (playback):</b> PowerPC G5 Dual or Core Duo, 2 GHz or better; Intel Core i5 or better recommended when viewing movies with a frame size of 1280×720 or more at a frame rate of 30 fps or above or movies with a frame size of 1920×1080 or more</li> <li>• <b>H.264 movies (editing):</b> 2.6 GHz or better Core 2 Duo</li> <li>• GPU that supports QuickTime H.264 hardware acceleration recommended</li> </ul>
OS	Pre-installed versions of Windows 7 Home Basic/Home Premium/Professional/Enterprise/Ultimate (Service Pack 1), Windows Vista Home Basic/Home Premium/Business/Enterprise/Ultimate (Service Pack 2), or Windows XP Home Edition/Professional (Service Pack 3). All installed programs may run as 32-bit applications in 64-bit editions of Windows 7 and Windows Vista. This application is not compatible with computers running 64-bit Windows XP.	Mac OS X version 10.5.8, or 10.6.8, 10.7.2
RAM	<ul style="list-style-type: none"> <li>• <b>Windows 7/Windows Vista:</b> 1 GB or more (2 GB or more recommended)</li> <li>• <b>Windows XP:</b> 512 MB or more (2 GB or more recommended)</li> </ul>	512 MB or more (2 GB or more recommended)
Hard-disk space	A minimum of 500 MB available on the startup disk (1 GB or more recommended)	
Monitor	<b>Resolution:</b> 1024×768 pixels (XGA) or more (1280×1024 pixels (SXGA) or more recommended) <b>Color:</b> 24-bit color (True Color) or more	<b>Resolution:</b> 1024×768 pixels (XGA) or more (1280×1024 pixels (SXGA) or more recommended) <b>Color:</b> 24-bit color (millions of colors) or more

# Using ViewNX 2

## Copy Pictures to the Computer

### 1 Choose how pictures will be copied to the computer.

Choose one of the following methods:

- **Direct USB connection:** Turn the camera off and ensure that the memory card is inserted in the camera. Connect the camera to the computer using the supplied UC-E17 USB cable and then turn the camera on.

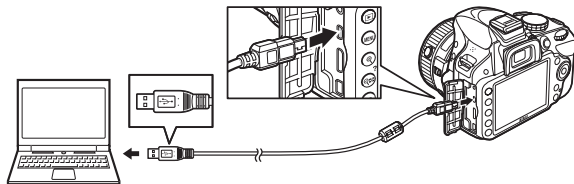

- **SD card slot:** If your computer is equipped with an SD card slot, the card can be inserted directly in the slot.
- **SD card reader:** Connect a card reader (available separately from third-party suppliers) to the computer and insert the memory card.

### 2 Start Nikon Transfer 2.

If a message is displayed prompting you to choose a program, select Nikon Transfer 2.

#### Windows 7

If the following dialog is displayed, select Nikon Transfer 2 as described below.

- 1 Under **Import pictures and videos**, click **Change program**. A program selection dialog will be displayed; select **Import File using Nikon Transfer 2** and click **OK**.

- 2 Double-click **Import File**.

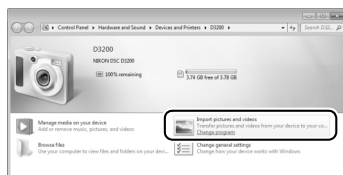

### 3 Click Start Transfer.

At default settings, all the pictures on the memory card will be copied to the computer.



**Start Transfer**

## 4 Terminate the connection.

If the camera is connected to the computer, turn the camera off and disconnect the USB cable. If you are using a card reader or card slot, choose the appropriate option in the computer operating system to eject the removable disk corresponding to the memory card and then remove the card from the card reader or card slot.

## View Pictures

Pictures are displayed in ViewNX 2 when transfer is complete.

### Starting ViewNX 2 Manually

- Windows: Double-click the ViewNX 2 shortcut on the desktop.
- Mac OS: Click the ViewNX 2 icon in the Dock.



### Retouching Photographs

To crop pictures and perform such tasks as adjusting sharpness and tone levels, click the **Edit** button in the ViewNX 2 toolbar.

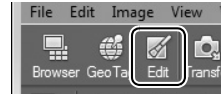

### Editing Movies

To perform such tasks as trimming unwanted footage from movies shot with the camera, click the **Movie Editor** button in the ViewNX 2 toolbar.

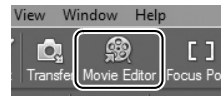

### Printing Pictures

Click the **Print** button in the ViewNX 2 toolbar. A dialog will be displayed, allowing you to print pictures on a printer connected to the computer.



### For More Information

Consult online help for more information on using ViewNX 2.

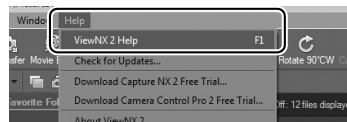

# Technical Notes

## Compatible Lenses

This camera supports autofocus with AF-S and AF-I CPU lenses only. AF-S lenses have names beginning with **AF-S**, AF-I lenses names beginning with **AF-I**. Autofocus is not supported with other autofocus (AF) lenses. The following table lists the features available with compatible lenses in viewfinder photography:

Lens/accessory	Camera setting		Focus			Mode		Metering		
	AF	MF (with electronic rangefinder)	MF	M	Other modes	[M]		[M]		
						3D	Color	3D	Color	
AF-S, AF-I NIKKOR <sup>1</sup>	✓	✓	✓	✓	✓	✓	—	—	✓ <sup>2</sup>	
Other type G or D AF NIKKOR <sup>1</sup>	—	✓	✓	✓	✓	✓	—	—	✓ <sup>2</sup>	
PC-E NIKKOR series	—	✓ <sup>3</sup>	✓	✓ <sup>3</sup>	✓ <sup>3</sup>	✓ <sup>3</sup>	—	—	✓ <sup>2,3</sup>	
PC Micro 85mm f/2.8D <sup>4</sup>	—	✓ <sup>3</sup>	✓	✓	—	✓	—	—	✓ <sup>2,3</sup>	
AF-S/AF-I teleconverter <sup>5</sup>	✓ <sup>6</sup>	✓ <sup>6</sup>	✓	✓	✓	✓	—	—	✓ <sup>2</sup>	
Other AF NIKKOR (except lenses for F3AF)	—	✓ <sup>7</sup>	✓	✓	✓	✓	—	—	✓ <sup>2</sup>	
AI-P NIKKOR	—	✓ <sup>8</sup>	✓	✓	✓	✓	—	—	✓ <sup>2</sup>	

1 Use AF-S or AF-I lenses to get the most from your camera. Vibration Reduction (VR) supported with VR lenses.

2 Spot metering meters selected focus point.

3 Can not be used with shifting or tilting.

4 The camera's exposure metering and flash control systems may not function as expected when the lens is shifted and/or tilted or an aperture other than the maximum aperture is used.

5 AF-S or AF-I lens required.

6 With maximum effective aperture of f/5.6 or faster.

7 When AF 80–200mm f/2.8, AF 35–70mm f/2.8, AF 28–85mm f/3.5–4.5 (New), or AF 28–85mm f/3.5–4.5 lenses are zoomed all the way in at the minimum focus distance, the in-focus indicator may be displayed when the image on the matte screen in the viewfinder is not in focus. Focus manually until image in viewfinder is in focus.

8 With maximum aperture of f/5.6 or faster.

### Identifying CPU and Type G and D Lenses

CPU lenses can be identified by the presence of CPU contacts, type G and D lenses by a letter on the lens barrel. Type G lenses are not equipped with a lens aperture ring.

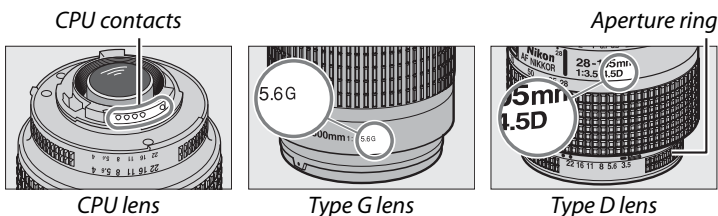

### IX NIKKOR Lenses

IX NIKKOR lenses can not be used.

### Lens f-number

The f-number given in lens names is the maximum aperture of the lens.

# Other Accessories

At the time of writing, the following accessories were available for the D3200.

<b>Power sources</b>	<ul style="list-style-type: none"><li>• <b>Rechargeable Li-ion Battery EN-EL14</b> (🔋 6): Additional EN-EL14 batteries are available from local retailers and Nikon-authorized service representatives. EN-EL14a batteries can also be used.</li><li>• <b>Battery Charger MH-24</b> (🔋 6): Recharge EN-EL14a and EN-EL14 batteries.</li><li>• <b>Power Connector EP-5A, AC Adapter EH-5b</b>: These accessories can be used to power the camera for extended periods (EH-5a and EH-5 AC adapters can also be used). A power connector EP-5A is required to connect the camera to the EH-5b, EH-5a or EH-5.</li></ul>
<b>Filters</b>	<ul style="list-style-type: none"><li>• Filters intended for special-effects photography may interfere with autofocus or the electronic rangefinder.</li><li>• The D3200 can not be used with linear polarizing filters. Use C-PL or C-PL II circular polarizing filters instead.</li><li>• NC filters are recommended for protecting the lens.</li><li>• To prevent ghosting, use of a filter is not recommended when the subject is framed against a bright light, or when a bright light source is in the frame.</li><li>• Center-weighted metering is recommended with filters with exposure factors (filter factors) over <math>1 \times</math> (Y44, Y48, Y52, O56, R60, X0, X1, C-PL, ND2S, ND4, ND4S, ND8, ND8S, ND400, A2, A12, B2, B8, B12). See the filter manual for details.</li></ul>
<b>Viewfinder eyepiece accessories</b>	<ul style="list-style-type: none"><li>• <b>DK-20C Eyepiece Correction Lenses</b>: Lenses are available with diopters of <math>-5</math>, <math>-4</math>, <math>-3</math>, <math>-2</math>, <math>0</math>, <math>+0.5</math>, <math>+1</math>, <math>+2</math>, and <math>+3 \text{ m}^{-1}</math> when the camera diopter adjustment control is in the neutral position (<math>-1 \text{ m}^{-1}</math>). Use eyepiece correction lenses only if the desired focus can not be achieved with the built in diopter adjustment control (<math>-1.7</math> to <math>+0.5 \text{ m}^{-1}</math>). Test eyepiece correction lenses before purchase to ensure that the desired focus can be achieved. The rubber eyecup can not be used with eyepiece correction lenses.</li><li>• <b>Magnifier DG-2</b>: The DG-2 magnifies the scene displayed in the center of the viewfinder for greater precision during focusing. Eyepiece adapter required (available separately).</li><li>• <b>Eyepiece Adapter DK-22</b>: The DK-22 is used when attaching the DG-2 magnifier.</li><li>• <b>Right-Angle Viewing Attachment DR-6</b>: The DR-6 attaches at a right angle to the viewfinder eyepiece, allowing the image in the viewfinder to be viewed at right angles to the lens (for example, from directly above when the camera is horizontal).</li></ul>
 <b>Software</b>	<p><b>Capture NX 2</b>: A complete photo editing package offering such features as white balance adjustment and color control points.</p> <p><b>Note</b>: Use the latest versions of Nikon software. Most Nikon software offers an auto update feature when the computer is connected to the Internet. See the websites listed on page vii for the latest information on supported operating systems.</p>

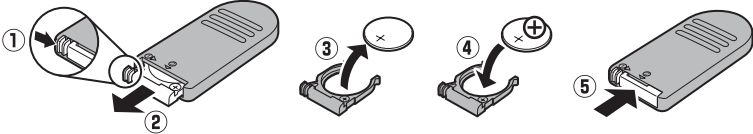
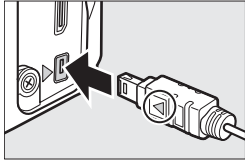

<b>Body cap</b>	<b>Body Cap BF-1B/Body Cap BF-1A:</b> The body cap keeps the mirror, viewfinder screen, and low-pass filter free of dust when a lens is not in place.	
<b>Remote controls</b>	<b>ML-L3 wireless remote control</b> (☐ 27): The ML-L3 uses a 3 V CR2025 battery.  <p>Pressing the battery-chamber latch to the right (①), insert a fingernail into the gap and open the battery chamber (②). Ensure that the battery is inserted in the correct orientation (④).</p>	
<b>Microphones</b>	<b>Stereo Microphone ME-1</b> (☐ 52)	
<b>Accessory terminal accessories</b>	The D3200 is equipped with an accessory terminal for <b>MC-DC2 remote cords</b> and <b>GP-1 GPS units</b> , which connect with the ◀ mark on the connector aligned with the ▶ next to the accessory terminal (close the connector cover when the terminal is not in use). 	
<b>USB and A/V connector accessories</b>	<ul style="list-style-type: none"> <li>• <b>UC-E17 and UC-E6 USB cables</b> (☐ 60)</li> <li>• <b>Wireless Mobile Adapter WU-1a:</b> Supports two-way communication between the camera and smart devices running the Wireless Mobile Adapter Utility.</li> </ul>	

## Approved Memory Cards

The following SD memory cards have been tested and approved for use in the D3200. Cards with class 6 or faster write speeds are recommended for movie recording. Recording may end unexpectedly when cards with slower write speeds are used.

	SD memory cards	SDHC memory cards <sup>2</sup>	SDXC memory cards <sup>3</sup>
<b>SanDisk</b>	2 GB <sup>1</sup>	4 GB, 8 GB, 16 GB, 32 GB	64 GB
<b>Toshiba</b>			
<b>Panasonic</b>		4 GB, 6 GB, 8 GB, 12 GB, 16 GB, 24 GB, 32 GB	48 GB, 64 GB
<b>Lexar Media</b>			
<b>Platinum II</b>		4 GB, 8 GB, 16 GB, 32 GB	—
<b>Professional</b>		4 GB, 8 GB, 16 GB, 32 GB, 64 GB, 128 GB	
<b>Full-HD Video</b>	—	4 GB, 8 GB, 16 GB	

- 1 Check that any card readers or other devices with which the card will be used support 2 GB cards.
- 2 Check that any card readers or other devices with which the card will be used are SDHC-compliant. The camera supports UHS-1.
- 3 Check that any card readers or other devices with which the card will be used are SDXC-compliant. The camera supports UHS-1.



Other cards have not been tested. For more details on the above cards, please contact the manufacturer.

# Caring for the Camera

## Storage

When the camera will not be used for an extended period, remove the battery and store it in a cool, dry area with the terminal cover in place. To prevent mold or mildew, store the camera in a dry, well-ventilated area. Do not store your camera with naphtha or camphor moth balls or in locations that:

- are poorly ventilated or subject to humidities of over 60%
- are next to equipment that produces strong electromagnetic fields, such as televisions or radios
- are exposed to temperatures above 50 °C (122 °F) or below –10 °C (14 °F)

## Cleaning

<b>Camera body</b>	Use a blower to remove dust and lint, then wipe gently with a soft, dry cloth. After using the camera at the beach or seaside, wipe off sand or salt with a cloth lightly dampened in distilled water and dry thoroughly. <b>Important:</b> <i>Dust or other foreign matter inside the camera may cause damage not covered under warranty.</i>
<b>Lens, mirror, and viewfinder</b>	These glass elements are easily damaged. Remove dust and lint with a blower. If using an aerosol blower, keep the can vertical to prevent the discharge of liquid. To remove fingerprints and other stains, apply a small amount of lens cleaner to a soft cloth and clean with care.
<b>Monitor</b>	Remove dust and lint with a blower. When removing fingerprints and other stains, wipe the surface lightly with a soft cloth or chamois leather. Do not apply pressure, as this could result in damage or malfunction.

*Do not use alcohol, thinner, or other volatile chemicals.*

### **Servicing the Camera and Accessories**

The camera is a precision device and requires regular servicing. Nikon recommends that the camera be inspected by the original retailer or Nikon-authorized service representative once every one to two years, and that it be serviced once every three to five years (note that fees apply to these services). Frequent inspection and servicing are particularly recommended if the camera is used professionally. Any accessories regularly used with the camera, such as lenses or optional flash units, should be included when the camera is inspected or serviced.

# Caring for the Camera and Battery: Cautions

## Caring for the Camera

**Do not drop:** The product may malfunction if subjected to strong shocks or vibration.

**Keep dry:** This product is not waterproof, and may malfunction if immersed in water or exposed to high levels of humidity. Rusting of the internal mechanism can cause irreparable damage.

**Avoid sudden changes in temperature:** Sudden changes in temperature, such as those that occur when entering or leaving a heated building on a cold day, can cause condensation inside the device. To prevent condensation, place the device in a carrying case or plastic bag before exposing it to sudden changes in temperature.

**Keep away from strong magnetic fields:** Do not use or store this device in the vicinity of equipment that generates strong electromagnetic radiation or magnetic fields. Strong static charges or the magnetic fields produced by equipment such as radio transmitters could interfere with the monitor, damage data stored on the memory card, or affect the product's internal circuitry.

**Do not leave the lens pointed at the sun:** Do not leave the lens pointed at the sun or other strong light source for an extended period. Intense light may cause the image sensor to deteriorate or produce a white blur effect in photographs.

**Turn the product off before removing or disconnecting the power source:** Do not unplug the product or remove the battery while the product is on or while images are being recorded or deleted. Forcibly cutting power in these circumstances could result in loss of data or in damage to product memory or internal circuitry. To prevent an accidental interruption of power, avoid carrying the product from one location to another while the AC adapter is connected.

**Cleaning:** When cleaning the camera body, use a blower to gently remove dust and lint, then wipe gently with a soft, dry cloth. After using the camera at the beach or seaside, wipe off any sand or salt using a cloth lightly dampened in pure water and then dry the camera thoroughly.

The lens and mirror are easily damaged. Dust and lint should be gently removed with a blower. When using an aerosol blower, keep the can vertical to prevent discharge of liquid. To remove fingerprints and other stains from the lens, apply a small amount of lens cleaner to a soft cloth and wipe the lens carefully.

See the *Reference Manual* for information on cleaning the low-pass filter.

**Do not touch the shutter curtain:** The shutter curtain is extremely thin and easily damaged. Under no circumstances should you exert pressure on the curtain, poke it with cleaning tools, or subject it to powerful air currents from a blower. These actions could scratch, deform, or tear the curtain.



**Storage:** To prevent mold or mildew, store the camera in a dry, well-ventilated area. If you are using an AC adapter, unplug the adapter to prevent fire. If the product will not be used for an extended period, remove the battery to prevent leakage and store the camera in a plastic bag containing a desiccant. Do not, however, store the camera case in a plastic bag, as this may cause the material to deteriorate. Note that desiccant gradually loses its capacity to absorb moisture and should be replaced at regular intervals.

To prevent mold or mildew, take the camera out of storage at least once a month. Turn the camera on and release the shutter a few times before putting it away.

Store the battery in a cool, dry place. Replace the terminal cover before putting the battery away.

**Notes on the monitor:** The monitor is constructed with extremely high precision; at least 99.99% of pixels are effective, with no more than 0.01% being missing or defective. Hence while these displays may contain pixels that are always lit (white, red, blue, or green) or always off (black), this is not a malfunction and has no effect on images recorded with the device.

Images in the monitor may be difficult to see in a bright light.

Do not apply pressure to the monitor, as this could cause damage or malfunction. Dust or lint on the monitor can be removed with a blower. Stains can be removed by wiping lightly with a soft cloth or chamois leather. Should the monitor break, care should be taken to avoid injury from broken glass and to prevent liquid crystal from the monitor touching the skin or entering the eyes and mouth.

**Moiré:** Moiré is an interference pattern created by the interaction of an image containing a regular, repeating grid, such as the pattern of weave in cloth or windows in a building, with the camera image sensor grid. If you notice moiré in your photographs, try changing the distance to the subject, zooming in and out, or changing the angle between the subject and the camera.

## Caring for the Battery

Batteries may leak or explode if improperly handled. Observe the following precautions when handling batteries:

- Use only batteries approved for use in this equipment.
- Do not expose the battery to flame or excessive heat.
- Keep the battery terminals clean.
- Turn the product off before replacing the battery.
- Remove the battery from the camera or charger when not in use and replace the terminal cover. These devices draw minute amounts of charge even when off and could draw the battery down to the point that it will no longer function. If the battery will not be used for some time, insert it in the camera and run it flat before removing it and storing it in a location with an ambient temperature of 15 to 25 °C (59 to 77 °F; avoid hot or extremely cold locations). Repeat this process at least once every six months.
- Turning the camera on and off repeatedly when the battery is fully discharged will shorten battery life. Batteries that have been fully discharged must be charged before use.





- The internal temperature of the battery may rise while the battery is in use. Attempting to charge the battery while the internal temperature is elevated will impair battery performance, and the battery may not charge or charge only partially. Wait for the battery to cool before charging.
- Continuing to charge the battery after it is fully charged can impair battery performance.
- A marked drop in the time a fully charged battery retains its charge when used at room temperature indicates that it requires replacement. Purchase a new EN-EL14 battery.
- Charge the battery before use. When taking photographs on important occasions, ready a spare EN-EL14 battery and keep it fully charged. Depending on your location, it may be difficult to purchase replacement batteries on short notice. Note that on cold days, the capacity of batteries tends to decrease. Be sure the battery is fully charged before taking photographs outside in cold weather. Keep a spare battery in a warm place and exchange the two as necessary. Once warmed, a cold battery may recover some of its charge.
- Used batteries are a valuable resource; recycle in accord with local regulations.



















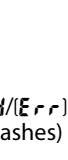

# Error Messages

This section lists the indicators and error messages that appear in the viewfinder and monitor.

## Warning Icons

A flashing  in the monitor or  in the viewfinder indicates that a warning or error message can be displayed in the monitor by pressing the  (?) button.

Indicator		Solution
Monitor	Viewfinder	
Lock lens aperture ring at minimum aperture (largest f-number).	 (flashes)	Set lens aperture ring to minimum aperture (highest f-number).
Lens not attached	 (flashes)	<ul style="list-style-type: none"> <li>• Attach non-IX NIKKOR lens.</li> <li>• If non-CPU lens is attached, select mode M.</li> </ul>
Before taking photos, rotate the zoom ring to extend the lens.	 (flashes)	A lens with a retractable lens barrel button is attached with the lens barrel retracted. Press the retractable lens barrel button and rotate the zoom ring to extend the lens.
Shutter release disabled. Recharge battery.	 /? (flashes)	Turn camera off and recharge or replace battery.
This battery cannot be used. Choose battery designated for use in this camera.	 (flashes)	Use Nikon-approved battery.
Initialization error. Turn camera off and then on again.	 /[E r r] (flashes)	Turn camera off, remove and replace battery, and then turn camera on again.
Battery level is low. Complete operation and turn camera off immediately.	—	End cleaning and turn camera off and recharge or replace battery.
Clock not set	—	Set camera clock.
No SD card inserted	 (flashes)	Turn camera off and confirm that card is correctly inserted.
Memory card is locked. Slide lock to “write” position.	 (flashes)	Memory card is locked (write protected). Slide card write-protect switch to “write” position.
This memory card cannot be used. Card may be damaged. Insert another card.	 (flashes)	<ul style="list-style-type: none"> <li>• Use approved card.</li> <li>• Format card. If problem persists, card may be damaged. Contact Nikon-authorized service representative.</li> <li>• Error creating new folder. Delete files or insert new memory card.</li> <li>• Insert new memory card.</li> <li>• Eye-Fi card is still emitting wireless signal after <b>Disable</b> has been selected for <b>Eye-Fi upload</b>. To terminate wireless transmission, turn the camera off and remove the card.</li> </ul>

Indicator		Solution
Monitor	Viewfinder	
<b>Not available if Eye-Fi card is locked.</b>	 (flashes)	Eye-Fi card is locked (write protected). Slide card write-protect switch to “write” position.
<b>This card is not formatted. Format card?</b>	 (flashes)	Format card or turn camera off and insert new memory card.
<b>Card is full</b>	 (flashes)	<ul style="list-style-type: none"> <li>• Reduce quality or size.</li> <li>• Delete photographs.</li> <li>• Insert new memory card.</li> </ul>
—	 (flashes)	Camera can not focus using autofocus. Change composition or focus manually.
<b>Subject is too bright</b>	 (flashes)	<ul style="list-style-type: none"> <li>• Use a lower ISO sensitivity.</li> <li>• Use commercial ND filter.</li> <li>• In mode: <ul style="list-style-type: none"> <li><b>S</b> Increase shutter speed</li> <li><b>A</b> Choose a smaller aperture (higher f-number)</li> </ul> </li> </ul>
<b>Subject is too dark</b>		<ul style="list-style-type: none"> <li>• Use a higher ISO sensitivity.</li> <li>• Use flash.</li> <li>• In mode: <ul style="list-style-type: none"> <li><b>S</b> Lower shutter speed</li> <li><b>A</b> Choose a larger aperture (lower f-number)</li> </ul> </li> </ul>
<b>No Bulb in S mode</b>	 (flashes)	Change shutter speed or select manual exposure mode.
—	 (flashes)	Flash has fired at full power. Check photo in monitor; if underexposed, adjust settings and try again.
—	 (flashes)	<ul style="list-style-type: none"> <li>• Use the flash.</li> <li>• Change distance to subject, aperture, flash range, or ISO sensitivity.</li> <li>• Lens focal length is less than 18 mm: use a longer focal length.</li> <li>• Optional SB-400 flash unit attached: flash is in bounce position or focus distance is very short. Continue shooting; if necessary, increase focus distance to prevent shadows from appearing in photograph.</li> </ul>
<b>Flash error</b>	 (flashes)	Error occurred updating firmware for optional flash unit. Contact Nikon-authorized service representative.



Indicator		Solution
Monitor	Viewfinder	
<b>Error. Press shutter release button again.</b>	Err (flashes)	Release shutter. If error persists or appears frequently, consult Nikon-authorized service representative.
<b>Start-up error. Contact a Nikon-authorized service representative.</b>		Consult Nikon-authorized service representative.
<b>Metering error</b>		
<b>Unable to start live view. Please wait for camera to cool.</b>	—	Wait for the internal circuits to cool before resuming live view or movie recording.
<b>Folder contains no images.</b>	—	Folder selected for playback contains no images. Insert another memory card or select a different folder.
<b>Cannot display this file.</b>	—	File can not be played back on camera.
<b>Cannot select this file.</b>	—	Images created with other devices can not be retouched.
<b>No image for retouching.</b>	—	Memory card does not contain NEF (RAW) images for use with <b>NEF (RAW) processing</b> .
<b>Check printer.</b>	—	Check printer. To resume, select <b>Continue</b> (if available).*
<b>Check paper.</b>	—	Paper is not selected size. Insert paper of correct size and select <b>Continue</b> .*
<b>Paper jam.</b>	—	Clear jam and select <b>Continue</b> .*
<b>Out of paper.</b>	—	Insert paper of selected size and select <b>Continue</b> .*
<b>Check ink supply.</b>	—	Check ink. To resume, select <b>Continue</b> .*
<b>Out of ink.</b>	—	Replace ink and select <b>Continue</b> .*

\* See printer manual for more information.





















# Specifications

## ■ Nikon D3200 Digital Camera

<b>Type</b>	
Type	Single-lens reflex digital camera
Lens mount	Nikon F mount (with AF contacts)
Effective angle of view	Approx. $1.5 \times$ lens focal length (35 mm format equivalent); Nikon DX format
<b>Effective pixels</b>	
Effective pixels	24.2 million
<b>Image sensor</b>	
Image sensor	23.2 $\times$ 15.4 mm CMOS sensor
Total pixels	24.7 million
Dust-reduction System	Image sensor cleaning, Image Dust Off reference data (optional Capture NX 2 software required)
<b>Storage</b>	
Image size (pixels)	<ul style="list-style-type: none"><li>• 6,016 <math>\times</math> 4,000 (Large)</li><li>• 3,008 <math>\times</math> 2,000 (Small)</li><li>• 4,512 <math>\times</math> 3,000 (Medium)</li></ul>
File format	<ul style="list-style-type: none"><li>• <b>NEF (RAW)</b>: 12 bit, compressed</li><li>• <b>JPEG</b>: JPEG-Baseline compliant with fine (approx. 1 : 4), normal (approx. 1 : 8), or basic (approx. 1 : 16) compression</li><li>• <b>NEF (RAW)+JPEG</b>: Single photograph recorded in both NEF (RAW) and JPEG formats</li></ul>
Picture Control System	Standard, Neutral, Vivid, Monochrome, Portrait, Landscape; selected Picture Control can be modified
Media	SD (Secure Digital) and UHS-I compliant SDHC and SDXC memory cards
File system	DCF (Design Rule for Camera File System) 2.0, DPOF (Digital Print Order Format), Exif (Exchangeable Image File Format for Digital Still Cameras) 2.3, PictBridge
<b>Viewfinder</b>	
Viewfinder	Eye-level pentamirror single-lens reflex viewfinder
Frame coverage	Approx. 95% horizontal and 95% vertical
Magnification	Approx. $0.8 \times$ (50 mm f/1.4 lens at infinity, $-1.0 \text{ m}^{-1}$ )
Eyepoint	18 mm ( $-1.0 \text{ m}^{-1}$ ; from center surface of viewfinder eyepiece lens)
Diopter adjustment	$-1.7$ – $+0.5 \text{ m}^{-1}$
Focusing screen	Type B BriteView Clear Matte Mark VII screen
Reflex mirror	Quick return
Lens aperture	Instant return, electronically controlled





Lens	
<b>Compatible lenses</b>	Autofocus is available with AF-S and AF-I lenses. Autofocus is not available with other type G and D lenses, AF lenses (IX NIKKOR and lenses for the F3AF are not supported), and AI-P lenses. Non-CPU lenses can be used in mode <b>M</b> , but the camera exposure meter will not function.  The electronic rangefinder can be used with lenses that have a maximum aperture of f/5.6 or faster.
Shutter	
<b>Type</b>	Electronically-controlled vertical-travel focal-plane shutter
<b>Speed</b>	$1/4000 - 30$ s in steps of $1/3$ EV; Bulb; Time (requires optional ML-L3 remote control)
<b>Flash sync speed</b>	$X = 1/200$ s; synchronizes with shutter at $1/200$ s or slower
Release	
<b>Release mode</b>	 (single frame),  (continuous),  (self-timer),  2s (delayed remote),  (quick-response remote),  (quiet shutter release)
<b>Frame advance rate</b>	Up to 4 fps (manual focus, mode <b>M</b> or <b>S</b> , shutter speed $1/250$ s or faster, and other settings at default values)
<b>Self-timer</b>	2 s, 5 s, 10 s, 20 s; 1–9 exposures
Exposure	
<b>Metering</b>	TTL exposure metering using 420-pixel RGB sensor
<b>Metering method</b>	<ul style="list-style-type: none"> <li>• <b>Matrix metering:</b> 3D color matrix metering II (type G and D lenses); color matrix metering II (other CPU lenses)</li> <li>• <b>Center-weighted metering:</b> Weight of 75% given to 8-mm circle in center of frame</li> <li>• <b>Spot metering:</b> Meters 3.5-mm circle (about 2.5% of frame) centered on selected focus point</li> </ul>
<b>Range (ISO 100, f/1.4 lens, 20 °C/68 °F)</b>	<ul style="list-style-type: none"> <li>• <b>Matrix or center-weighted metering:</b> 0–20 EV</li> <li>• <b>Spot metering:</b> 2–20 EV</li> </ul>
<b>Exposure meter coupling</b>	CPU
<b>Mode</b>	Auto modes (  auto;  auto (flash off)); scene modes (  portrait;  landscape;  child;  sports;  close up;  night portrait); programmed auto with flexible program ( <b>P</b> ); shutter-priority auto ( <b>S</b> ); aperture-priority auto ( <b>A</b> ); manual ( <b>M</b> )
<b>Exposure compensation</b>	–5 – +5 EV in increments of $1/3$ EV
<b>Exposure lock</b>	Luminosity locked at detected value with $AE-L/AF-L$ (  <b>AE-L</b> ) button
<b>ISO sensitivity (Recommended Exposure Index)</b>	ISO 100 – 6400 in steps of 1 EV; can also be set to approx. 1 EV above ISO 6400 (ISO 12800 equivalent); auto ISO sensitivity control available
<b>Active D-Lighting</b>	On, off

Focus	
<b>Autofocus</b>	Nikon Multi-CAM 1000 autofocus sensor module with TTL phase detection, 11 focus points (including one cross-type sensor), and AF-assist illuminator (range approx. 0.5–3 m/1 ft 8 in.–9 ft 10 in.)
<b>Detection range</b>	–1 – +19 EV (ISO 100, 20 °C/68 °F)
<b>Lens servo</b>	<ul style="list-style-type: none"> <li>• <b>Autofocus (AF):</b> Single-servo AF (<b>AF-S</b>); continuous-servo AF (<b>AF-C</b>); auto AF-S/AF-C selection (<b>AF-A</b>); predictive focus tracking activated automatically according to subject status</li> <li>• <b>Manual focus (MF):</b> Electronic rangefinder can be used</li> </ul>
<b>Focus point</b>	Can be selected from 11 focus points
<b>AF-area mode</b>	Single-point AF, dynamic-area AF, auto-area AF, 3D-tracking (11 points)
<b>Focus lock</b>	Focus can be locked by pressing shutter-release button halfway (single-servo AF) or by pressing  ( <b>○m</b> ) button

Flash	
<b>Built-in flash</b>	 : Auto flash with auto pop-up <b>P, S, A, M:</b> Manual pop-up with button release
<b>Guide Number</b>	Approx. 12/39, 13/43 with manual flash (m/ft, ISO 100, 20 °C/68 °F)
<b>Flash control</b>	<b>TTL:</b> i-TTL flash control using 420-pixel RGB sensor is available with built-in flash and SB-910, SB-900, SB-800, SB-700, SB-600, or SB-400; i-TTL balanced fill-flash for digital SLR is used with matrix and center-weighted metering, standard i-TTL flash for digital SLR with spot metering
<b>Flash mode</b>	Auto, auto with red-eye reduction, auto slow sync, auto slow sync with red-eye reduction, fill-flash, red-eye reduction, slow sync, slow sync with red-eye reduction, rear-curtain with slow sync, rear-curtain sync, off
<b>Flash compensation</b>	–3 – +1 EV in increments of 1/3 EV
<b>Flash-ready indicator</b>	Lights when built-in flash or optional flash unit is fully charged; flashes after flash is fired at full output
<b>Accessory shoe</b>	ISO 518 hot-shoe with sync and data contacts and safety lock
<b>Nikon Creative Lighting System (CLS)</b>	Advanced Wireless Lighting supported with SB-910, SB-900, SB-800, or SB-700 as a master flash, or SU-800 as commander; Flash Color Information Communication supported with all CLS-compatible flash units
<b>Sync terminal</b>	AS-15 sync terminal adapter (available separately)
White balance	
<b>White balance</b>	Auto, incandescent, fluorescent (7 types), direct sunlight, flash, cloudy, shade, preset manual, all except preset manual with fine-tuning.



Live view	
<b>Lens servo</b>	<ul style="list-style-type: none"> <li>• <b>Autofocus (AF):</b> Single-servo AF (<b>AF-S</b>); full-time servo AF (<b>AF-F</b>)</li> <li>• <b>Manual focus (MF)</b></li> </ul>
<b>AF-area mode</b>	Face-priority AF, wide-area AF, normal-area AF, subject-tracking AF
<b>Autofocus</b>	Contrast-detect AF anywhere in frame (camera selects focus point automatically when face-priority AF or subject-tracking AF is selected)
<b>Automatic scene selection</b>	Available in  and  modes
Movie	
<b>Metering</b>	TTL exposure metering using main image sensor
<b>Metering method</b>	Matrix
<b>Frame size (pixels) and frame rate</b>	<ul style="list-style-type: none"> <li>• 1,920 × 1,080, 30 p (progressive)/25p/24p, ★ high/normal</li> <li>• 1,280 × 720, 60p/50p, ★ high/normal</li> <li>• 640 × 424, 30p/25p, ★ high/normal</li> </ul> <p>Frame rates of 30p (actual frame rate 29.97 fps) and 60p (actual frame rate 59.94 fps) are available when <b>NTSC</b> is selected for video mode. 25p and 50p are available when <b>PAL</b> is selected for video mode. Actual frame rate when 24p is selected is 23.976 fps.</p>
<b>File format</b>	MOV
<b>Video compression</b>	H.264/MPEG-4 Advanced Video Coding
<b>Audio recording format</b>	Linear PCM
<b>Audio recording device</b>	Built-in monaural or external stereo microphone; sensitivity adjustable
<b>ISO sensitivity</b>	ISO 200–6400; can also be set to approx. 1 EV above ISO 6400 (ISO 12800 equivalent)
Monitor	
<b>Monitor</b>	7.5-cm (3-in.), approx. 921k-dot (VGA) TFT LCD with 160 ° viewing angle, approx. 100% frame coverage, and brightness adjustment
Playback	
<b>Playback</b>	Full-frame and thumbnail (4, 9, or 72 images or calendar) playback with playback zoom, movie playback, photo and/or movie slide shows, histogram display, highlights, auto image rotation, and image comment (up to 36 characters)
Interface	
<b>USB</b>	Hi-Speed USB
<b>Video output</b>	NTSC, PAL
<b>HDMI output</b>	Type C mini-pin HDMI connector
<b>Accessory terminal</b>	<b>Remote cord:</b> MC-DC2 (available separately) <b>GPS unit:</b> GP-1 (available separately)
<b>Audio input</b>	Stereo mini-pin jack (3.5mm diameter)

<b>Supported languages</b>	
<b>Supported languages</b>	Arabic, Chinese (Simplified and Traditional), Czech, Danish, Dutch, English, Finnish, French, German, Greek, Hindi, Hungarian, Indonesian, Italian, Japanese, Korean, Norwegian, Polish, Portuguese (Portugal and Brazil), Romanian, Russian, Spanish, Swedish, Thai, Turkish, Ukrainian
<b>Power source</b>	
<b>Battery</b>	One rechargeable Li-ion EN-EL14 battery
<b>AC adapter</b>	EH-5b AC adapter; requires EP-5A power connector (available separately)
<b>Tripod socket</b>	
<b>Tripod socket</b>	1/4 in. (ISO 1222)
<b>Dimensions/weight</b>	
<b>Dimensions (W × H × D)</b>	Approx. 125 × 96 × 76.5 mm (5.0 × 3.8 × 3.1 in.)
<b>Weight</b>	Approx. 505 g (1 lb 1.8 oz) with battery and memory card but without body cap; approx. 455 g/1 lb (camera body only)
<b>Operating environment</b>	
<b>Temperature</b>	0–40 °C (+32–104 °F)
<b>Humidity</b>	Less than 85% (no condensation)

- Unless otherwise stated, all figures are for a camera with a fully-charged battery operating at an ambient temperature of 20 °C (68 °F).
- Nikon reserves the right to change the specifications of the hardware and software described in this manual at any time and without prior notice. Nikon will not be held liable for damages that may result from any mistakes that this manual may contain.



## ■ ■ MH-24 battery charger

<b>Rated input</b>	AC 100–240 V, 50/60 Hz, 0.2 A maximum
<b>Rated output</b>	DC 8.4 V/0.9 A
<b>Supported batteries</b>	Nikon rechargeable Li-ion battery EN-EL14
<b>Charging time</b>	Approx. 1 hour and 30 minutes at an ambient temperature of 25 °C/77 °F when no charge remains
<b>Operating temperature</b>	0–40 °C (+32–104 °F)
<b>Dimensions (W × H × D)</b>	Approx. 70 × 26 × 97 mm (2.8 × 1.0 × 3.8 in.), excluding plug adapter
<b>Weight</b>	Approx. 96 g (3.4 oz), excluding plug adapter

## ■ ■ EN-EL14 rechargeable Li-ion battery

<b>Type</b>	Rechargeable lithium-ion battery
<b>Rated capacity</b>	7.4 V/1030 mAh
<b>Operating temperature</b>	0–40 °C (+32–104 °F)
<b>Dimensions (W × H × D)</b>	Approx. 38 × 53 × 14 mm (1.5 × 2.1 × 0.6 in.)
<b>Weight</b>	Approx. 48 g (1.7 oz), excluding terminal cover

## ■ ■ AF-S DX NIKKOR 18–55mm f/3.5–5.6G VR II lens

<b>Type</b>	Type G AF-S DX lens with built-in CPU and F mount
<b>Focal length</b>	18–55 mm
<b>Maximum aperture</b>	f/3.5–5.6
<b>Lens construction</b>	11 elements in 8 groups (including 1 aspherical lens element)
<b>Angle of view</b>	76 °–28 ° 50 ′
<b>Focal length scale</b>	Graduated in millimeters (18, 24, 35, 45, 55)
<b>Distance information</b>	Output to camera
<b>Zoom</b>	Manual zoom using independent zoom ring
<b>Focusing</b>	Autofocus controlled by Silent Wave Motor and separate focus ring for manual focus
<b>Vibration reduction</b>	Lens shift using voice coil motors (VCMs)
<b>Minimum focus distance</b>	<ul style="list-style-type: none"><li>• <b>AF:</b> 0.28 m (0.92 ft) from focal plane at all zoom positions</li><li>• <b>MF:</b> 0.25 m (0.82 ft) from focal plane at all zoom positions</li></ul>
<b>Diaphragm blades</b>	7 (rounded diaphragm opening)
<b>Diaphragm</b>	Fully automatic
<b>Aperture range</b>	<ul style="list-style-type: none"><li>• <b>18 mm focal length:</b> f/3.5–22</li><li>• <b>55 mm focal length:</b> f/5.6–36</li></ul> <p>The minimum aperture displayed may vary depending on the size of the exposure increment selected with the camera.</p>
<b>Metering</b>	Full aperture
<b>Filter-attachment size</b>	52 mm (P=0.75 mm)
<b>Dimensions</b>	Approx. 66 mm diameter × 59.5 mm (distance from camera lens-mount flange when lens is retracted)
<b>Weight</b>	Approx. 195 g (6.9 oz)

Nikon reserves the right to change the specifications of the hardware and software described in this manual at any time and without prior notice. Nikon will not be held liable for damages that may result from any mistakes that this manual may contain.

**AF-S DX NIKKOR 18–55mm f/3.5–5.6G VR II lens**

The lens generally used in this manual for illustrative purposes is an AF-S DX NIKKOR 18–55mm f/3.5–5.6G VR II.

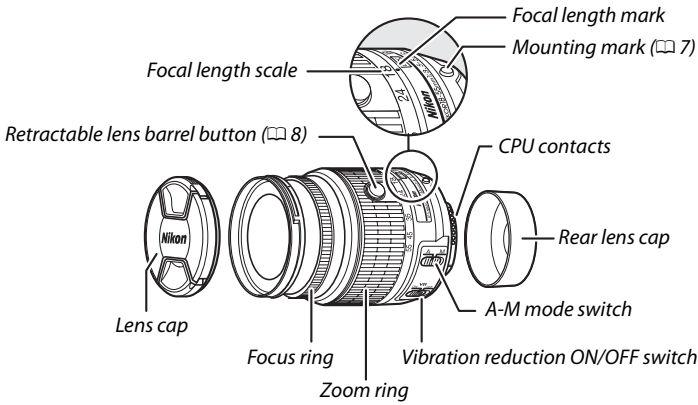

The AF-S DX NIKKOR 18–55mm f/3.5–5.6G VR II features a retractable lens barrel.



## **Battery Life**

The number of shots that can be taken with fully-charged batteries varies with the condition of the battery, temperature, and how the camera is used. Sample figures for EN-EL14 (1030 mAh) batteries are given below.

- **Single-frame release mode (CIPA standard <sup>1</sup>):** Approximately 540 shots
- **Continuous release mode (Nikon standard <sup>2</sup>):** Approximately 1800 shots
  - 1 Measured at 23 °C/73.4 °F (±2 °C/3.6 °F) with an AF-S DX NIKKOR 18–55mm f/3.5–5.6G VR II lens under the following test conditions: lens cycled from infinity to minimum range and one photograph taken at default settings once every 30 s; after photograph is taken, monitor is turned on for 4 s; tester waits for standby timer to expire after monitor is turned off; flash fired at full power once every other shot. Live view not used.
  - 2 Measured at 20 °C/68 °F with an AF-S DX NIKKOR 18–55mm f/3.5–5.6G VR II lens under the following test conditions: vibration reduction off, continuous release mode, focus mode set to **AF-C**, image quality set to JPEG basic, image size set to **M** (medium), white balance set to **AUTO**, ISO sensitivity set to ISO 100, shutter speed  $\frac{1}{250}$  s, focus cycled from infinity to minimum range three times after shutter-release button has been pressed halfway for 3 s; six shots are then taken in succession and monitor turned on for 4 s and then turned off; cycle repeated once standby timer has expired.

The following can reduce battery life:

- Using the monitor
- Keeping the shutter-release button pressed halfway
- Repeated autofocus operations
- Taking NEF (RAW) photographs
- Slow shutter speeds
- Using a GP-1 GPS unit
- Using a WU-1a wireless mobile adapter
- Using VR (vibration reduction) mode with VR lenses

To ensure that you get the most from rechargeable Nikon EN-EL14 batteries:

- Keep the battery contacts clean. Soiled contacts can reduce battery performance.
- Use batteries immediately after charging. Batteries will lose their charge if left unused.

## **Trademark Information**

IOS is a trademark or registered trademark of Cisco Systems, Inc., in the United States and/or other countries and is used under license. Macintosh, Mac OS, and QuickTime are registered trademarks of Apple Inc. in the United States and/or other countries. Microsoft, Windows, and Windows Vista are either registered trademarks, or trademarks of Microsoft Corporation in the United States and/or other countries. PictBridge logo is a trademark. The SD, SDHC, and SDXC logos are trademarks of the SD-3C, LLC. HDMI, the HDMI logo and High-Definition Multimedia Interface are trademarks or registered trademarks of HDMI Licensing LLC.

## **HDMI**

All other trade names mentioned in this manual or the other documentation provided with your Nikon product are trademarks or registered trademarks of their respective holders.





A series of horizontal lines for writing, consisting of 20 evenly spaced lines spanning the width of the page.



A series of 20 horizontal lines spaced evenly down the page, providing a template for handwriting practice.



No reproduction in any form of this manual, in whole or in part (except for brief quotation in critical articles or reviews), may be made without written authorization from NIKON CORPORATION.