

Nikon

En

Autofocus Speedlight

SB-800



Instruction Manual

CE

For your safety

Before using your product, please read the following safety precautions carefully and thoroughly to ensure correct and safe use and to help prevent damage to your Nikon product or injury to yourself or others. For quick reference by those who use the product, please keep these safety instructions near the product.

In this manual, safety instructions are indicated with these symbols:



WARNING

Disregarding instructions marked with this symbol could result in personal injury, or death and property damage.



CAUTION

Disregarding instructions marked with this symbol could result in property damage.

Symbol for separate collection applicable in European countries



This symbol indicates that this product is to be collected separately. The following apply only to users in European countries.

- This product is designated for separate collection at an appropriate collection point. Do not dispose of as household waste
- For more information, contact the retailer or the local authorities in charge of waste management.

WARNINGS for Speedlights

- 1 If corrosive liquids seep from the batteries and get in your eyes, immediately wash your eyes with running water and consult with a doctor.** Your eyes could be seriously damaged if they are not treated quickly.
- 2 If corrosive liquids seep from the batteries and come in contact with your skin or clothes, wash immediately with running water.** Prolonged contact could injure your skin.
- 3 Never attempt to disassemble or repair the flash unit by yourself,** as this could result in you receiving an electric shock and could also cause the unit to malfunction; such malfunction could lead to personal injury.
- 4 If the flash unit is dropped and damaged, do not touch any exposed interior metal parts.** Such parts, especially the speedlight's capacitor and associated parts, could be in a high-charge state and if touched could cause an electric shock. Disconnect the power or remove the batteries and be sure that you do not touch any of the product's electrical components, and then bring the flash unit to your local Nikon dealer or authorized service center for repair.
- 5 If you detect heat, smoke or notice a burning smell, immediately stop operation and remove the batteries** to prevent the unit from catching on fire or melting. Allow the flash unit to cool down so that you can safely touch it and remove the batteries. Then bring the unit to your local Nikon dealer or authorized service center for repair.
- 6 The flash unit should never be submerged in liquid or exposed to rain, saltwater or moisture unless it is properly protected from the liquids and moisture. Underwater use requires a certified underwater housing.** If water or moisture gets inside the unit, this could cause the unit to catch on fire or cause an electric shock. In such instances you should immediately remove the batteries from the speedlight and then bring the unit to your local Nikon dealer or authorized service center for repair.
Note: electronic devices that are penetrated by water or moisture are often not economically repairable.
- 7 Do not use the unit in the presence of flammable or explosive gas.** If the flash unit is operated in areas where there is a flammable gas, including propane, gasoline and dust, it could cause an explosion or fire.
- 8 Do not fire the flash unit directly at the driver of a moving car,** as this could temporarily impair the driver's vision and cause an accident.
- 9 Do not fire the flash unit directly into the eyes of someone that is at close range,** as it could damage their eyes' retinas. Never fire the flash unit closer than 1 meter from infants.

For your safety

- 10 Do not fire the unit while the flash head is touching a person or object.** Such use can result in the person being burned, and/or their clothes igniting from the heat of the flash's firing.
- 11 Keep small accessories out of the reach of children** to avoid the possibility of the accessory being swallowed. If an accessory is accidentally swallowed, immediately consult with a doctor.
- 12 Use only the batteries specified in this instruction manual.** Batteries other than those specified could leak corrosive liquids, explode or catch on fire or otherwise not perform satisfactorily.
- 13 Do not mix battery types, brands or old and new batteries,** as the batteries could leak corrosive liquids, explode or catch on fire. When using more than one battery in a product, always use identical batteries that were purchased at the same time.
- 14 Non-rechargeable batteries such as manganese, alkaline-manganese and lithium batteries should never be charged in a battery charger** because they could leak corrosive liquids, explode or catch on fire.
- 15 When using standard size (AA, AAA, C, D) or other common rechargeable batteries such as NiCd and Ni-MH battery types, or when recharging them, be sure to use only the battery charger specified by the battery maker and read the instructions thoroughly. Do not recharge these batteries with their terminals reversed in the charger or before the batteries have cooled off sufficiently** because they could leak corrosive liquids, explode or catch on fire. The same caution also applies to using the rechargeable batteries that may be supplied by the photo product's manufacturer.



CAUTIONS for Speedlights

- 1 Do not touch the flash unit with wet hands,** as this could cause an electric shock.
- 2 Keep the flash unit away from children to prevent them from putting the unit in or near their mouth, or otherwise touching a dangerous part of the product;** as such contact could cause an electric shock.
- 3 Do not apply strong physical shocks to the unit,** as this could cause a malfunction that could cause the unit to explode or catch on fire.
- 4 Never use active agents that contain flammable substances such as paint thinner, benzene or paint remover to clean the unit, and never store the unit in locations containing chemicals such as camphor and naphthalene,** as this could damage the plastic case, cause a fire or cause an electric shock.

- 5 Remove any batteries from the unit before storing the unit for a long time** to prevent the unit from catching on fire or leaking corrosive liquids.

WARNINGS for Batteries

- 1 Never heat or throw batteries into a fire**, as this could cause the batteries to leak corrosive liquids, generate heat or explode.
- 2 Do not short-circuit or disassemble the batteries** because this could cause the batteries to leak corrosive liquids, generate heat or explode.
- 3 Do not mix battery types, brands or old and new batteries**, as this could cause the batteries to leak corrosive liquids, generate heat or explode.
- 4 Do not install batteries in the reverse direction as this could cause the batteries to leak corrosive liquids, generate heat or explode. Even if only one battery is installed in reverse it will cause the speedlight to malfunction.**
- 5 Be sure to use the battery charger specified by the battery maker** to avoid the possibility of batteries leaking corrosive liquids, generating heat or exploding.
- 6 Do not carry or store batteries along with metallic materials such as necklaces and hair pins** because such materials could cause the batteries to short-circuit, leading to battery leakage, heat generation or an explosion. **In addition, specially when carrying a quantity of batteries, place them carefully in a storage case that prevents the battery terminals from touching another battery's terminals** because if they touch in reverse order it could also cause the batteries to short-circuit, leading to battery leakage, heat generation or an explosion.
- 7 If corrosive liquids seep from the batteries and get in your eyes, immediately wash your eyes with running water and consult with a doctor.** Your eyes could be seriously damaged if they are not treated quickly.
- 8 If corrosive liquids seep from the batteries and come in contact with your skin or clothes, wash immediately with running water.** Prolonged contact could injure your skin.
- 9 Always follow the warnings and instructions printed on the batteries** to avoid activities that could cause the batteries to leak corrosive liquids, generate heat or catch on fire.
- 10 Be sure to use only batteries specified in this instruction manual**, to avoid the possibility of batteries leaking corrosive liquids, generating heat or exploding.

For your safety

- 11 Never open the casing surrounding batteries or use batteries whose casing has been breached** as such batteries could leak corrosive liquids, generate heat or explode.
- 12 Keep batteries out of the reach of children** to help avoid the possibility of them being swallowed. If a battery is accidentally swallowed, immediately consult with a doctor.
- 13 Batteries should not be submerged in water, exposed to rain, moisture or saltwater unless they are properly protected from the wet environment.** If water or moisture gets inside the batteries, this could cause them to leak corrosive liquids or generate heat.
- 14 Do not use any battery that appears abnormal in any way, including a change in color or shape.** Such batteries could leak corrosive liquids or generate heat.
- 15 Stop recharging rechargeable batteries if you notice that recharging is not completed within the specified time** to help prevent the possibility of the battery leaking corrosive liquids or generating heat.
- 16 When recycling or disposing of batteries, be sure to insulate their terminals with tape.** If the battery's positive and negative terminals short-circuit after coming into contact with metallic objects, it could cause fire, heat generation or an explosion. Dispose of used batteries in accordance with local government regulations.
- 17 Non-rechargeable batteries should never be charged in a battery charger** because they could leak corrosive liquids or generate heat.
- 18 Remove dead batteries from your equipment immediately,** as they could leak corrosive liquids, generate heat or explode.



CAUTION for Batteries

Do not throw or apply strong physical shocks to the batteries as this could cause batteries to leak corrosive liquids, generate heat or explode.

Contents

Preparation

- For your safetyi-v
- Foreword4-6
- Tips on using the Speedlight7
- Camera groups and available flash modes8-9
- Speedlight parts and their functions10-11
- Control buttons12
- Icons on the LCD panel13-15
- Lenses16

• Basic operation17

- 1 Installing the batteries18-19
 - 2 Test firing (Confirming the exposure)20-21
 - 3 Attach the SB-800 to the camera and adjust
the flash head22-23
 - 4 Setting the ISO sensitivity24-25
 - 5 Adjust the zoom-head position26-27
 - 6 Setting the camera's exposure mode and
metering system28-29
 - 7 Setting the SB-800's flash mode30-31
 - 8 Compose the picture and shoot with flash32-33
- Using the SB-800 with the COOLPIX34

• Detailed operation35

- SB-800's available flash modes36
- TTL auto flash mode37
- Non-TTL auto flash mode38-41
- Manual mode42-50
- Notes on continuous flash shooting51
- Checking the correct exposure before shooting52

• Other functions53

- Exposure compensation and flash output level
compensation54-56
- Flash-shooting distance range with zoom lenses
having a variable aperture57
- Slow-sync flash mode, Red-eye reduction control,
and Rear-curtain sync58-59

· Auto FP High-Speed Sync mode	60
· Flash Value Lock (FV Lock)	61
· Autofocus flash operation in dim light	62-63
· Using the Quick Recycling Battery Pack SD-800	64-65
· Checking the illumination before actually taking the picture (Modeling illuminator)	66
· Custom functions	67
· Custom settings	68-70
• Advanced operations	71
· Overview of multiple flash operation	72-73
· Wireless multiple flash shooting	74-75
· Flash shooting in Advanced Wireless Lighting	76-83
· SU-4 type wireless multiple flash shooting	84-88
· Confirming wireless multiple flash operation using the ready-light or the beeping sound	89
· Multiple flash shooting using cords	90-93
· System chart for TTL multiple flash shooting using cords	94-95
· Flash shooting with digital SLRs cameras using colored gel filters	96-97
· Bounce flash operation	98-101
· Close-up flash operation	102-105
Flash shooting in the 1/300 TTL High-Speed Flash sync mode (F5 only)	106
• Reference information	107
· TTL auto flash modes available with the SB-800	108-110
· Optional accessories	111-113
· Tips on Speedlight care	114
· Notes on batteries	115
· Troubleshooting	116-118
· About the LCD panel	119
· Specifications	120-123
· Index	124-125

Preparation

This section provides preliminary information on using the SB-800.

Basic operation

Basic procedures to take simple, properly exposed flash photographs in the TTL auto flash mode.

Detailed operation

A variety of flash modes available with the SB-800 are explained.

Other functions

Detailed information on each function of the SB-800 is provided.

Advanced operations

Information on advanced flash shooting techniques using the SB-800 is described.

Reference information

Optional accessories, Troubleshooting, Speedlight care, Specifications, etc. are presented in this section.

Foreword

Thank you for purchasing the Nikon Speedlight SB-800. To get the most out of your Speedlight, please read this instruction manual thoroughly before use. Also, read the separate booklet, “A collection of example photos,” which provides an overview of the SB-800’s flash-shooting capabilities with example photos. In addition, keep your camera instruction manual handy for quick reference.

■ Main features and functions of the SB-800

- The SB-800 is a high-performance Speedlight with a guide number of 38/125 (ISO 100, m/ft.) or 53/174 (ISO 200, m/ft.) (at the 35mm zoom-head position, 20°C/68°F.) According to the camera and lens combination used with the SB-800, you can perform various types of TTL auto flash (p. 37), Non-TTL auto flash (p. 38), and Manual flash (p. 42).
- A power zoom function automatically adjusts the zoom-head position to match the lens focal length (with the exception of some camera/lens combinations) (p. 26). When the built-in wide-flash adapter is used or the Nikon Diffusion Dome is attached (p. 27), the zoom-head position is automatically set to match a 14mm or 17mm lens.
- The flash head tilts up to 90° or down to -7° and rotates horizontally 180° to the left and 90° to the right, enabling bounce flash (p. 98) or close-up flash photography (p. 102).
- The Nikon Creative Lighting System provides a variety of advanced wireless multiple flash operations when the SB-800 is used with compatible cameras (p. 5).
- When doing bounce flash or taking close-ups with flash, you can use the built-in wide-flash adapter in conjunction with Nikon Diffusion Dome to create extremely soft, diffused lighting with virtually no shadows, while maintaining balanced lighting for the main subject and the background (pp. 101, 104).
- Custom functions are provided to set values, or activate or cancel functions that are unnecessary to set each time (p. 67).

Life-long learning

As part of Nikon’s “Life-long learning” commitment to ongoing product support and education, continually-updated information is available on-line at the following sites:

- For users in the U.S.A.: <http://www.nikonusa.com/>
- For users in Europe: <http://www.europe-nikon.com/support>
- For users in Asia, Oceania, the Middle East, and Africa: <http://www.nikon-asia.com/>

Visit these sites to keep up-to-date with the latest product information, tips, answers to frequently-asked questions (FAQs), and general advice on digital imaging and photography. Additional information may be available from the Nikon representative in your area. See the URL below for contact information:
<http://nikonimaging.com/>

Nikon Creative Lighting System

The SB-800 features the Nikon Creative Lighting System (**CLS**). This system offers additional flash shooting possibilities with digital cameras by taking advantage of camera's digital communication capabilities. CLS is available only when the SB-800 is used with compatible Nikon cameras. The SB-800 offers these major features:

- **i-TTL mode**

This is a TTL auto flash mode in the Nikon Creative Lighting System. Monitor Preflashes are fired at all times. The subject is correctly exposed by the light from the flash lighting and the exposure is less affected by the ambient light (p. 37).

- **Advanced Wireless Lighting**

With the Advanced Wireless Lighting, wireless multiple flash operation in the TTL (i-TTL) mode can now be accomplished with digital SLRs. In this mode, you can divide the remote flash units into three groups and control the flash output independently for each group, expanding your range of creative multiple-flash shooting techniques (p. 76).

- **Flash Value Lock**

Flash Value, or "FV," is the amount of flash exposure for the subject. Using FV Lock with compatible cameras, you can lock in the appropriate flash exposure for the main subject. This flash exposure is locked in, even if you change the aperture or composition, or zoom the lens in and out (p. 61).

- **Flash Color Information Communication**

When the SB-800 is used with compatible digital SLRs, color temperature information is automatically transmitted to the camera. In this way, the camera's white balance is automatically adjusted to give you the correct color temperature when taking photographs with the SB-800.

- **Auto FP High-Speed Sync**

High-Speed flash synchronization at your camera's highest shutter speed is now possible. This is useful when you want to use a wider aperture to achieve shallow depth of field to blur the background (p. 60).

- **Wide-Area AF-Assist Illuminator**



In autofocus operation, the SB-800 emits AF-Assist illumination over a wider area. This enables you to perform autofocus photography in dim light even when you change the camera's focus area with cameras supporting this function (p. 62).

See your equivalent camera's instruction manual for details on the Nikon Creative Lighting System.

■ Notes

- **Default:** Functions and flash modes preset when shipped from the factory are referred to as “Default” settings in this manual.
- **CLS:** Hereafter, Nikon’s new Speedlight system “Nikon **C**reative **L**ighting **S**ystem” is abbreviated “**CLS**.”

■ Marks used in this manual

- : Denotes important points to prevent malfunction or shooting failure.
- : Useful points that should be remembered for better usage of the SB-800.
- : Provides convenient reference information when using the SB-800

■ Supplied accessories

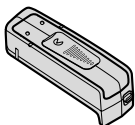

Quick Recycling Battery Pack
SD-800



Speedlight Stand
AS-19

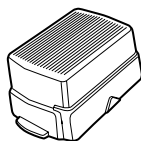

Nikon Diffusion Dome
SW-10H

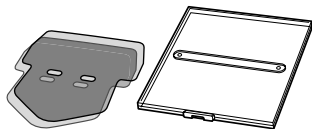

Colored Gel Filter Set SJ-800:
FL-G1, TN-A1

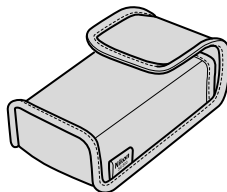

Soft Case SS-800

Tips on using the Speedlight

Take trial shots

Make trial shots before photographing important occasions like weddings or graduations.

Have Nikon spot-check your Speedlight regularly

Nikon recommends that you have your Speedlight serviced by an authorized dealer or service center at least once every two years.

Using your Speedlight correctly

The Nikon Speedlight SB-800's performance has been optimized for use with Nikon brand cameras/accessories including lenses.

Camera/accessories made by other manufacturers may not meet Nikon's criteria for specifications, and nonconforming cameras/accessories could damage the SB-800's components. Nikon cannot guarantee the SB-800's performance when used with non-Nikon products.





Notes:



- *The Nikon N90s, N90, N75-Series, N70, N60, N55-Series, N50, N8008, N8008s, PRONEA 6i, N6006, N6000, N5005, N4004s and N4004 are sold exclusively in the U.S.A.*
- *The Nikon N80-Series, N65-Series are sold exclusively in the U.S.A. and Central and South America.*
- *The Nikon N2020 and N2000 are sold exclusively in the U.S.A and Canada.*

Camera groups and available flash modes

In this manual, Nikon cameras are divided into 10 groups, including cameras compatible with CLS*, digital SLRs not compatible with CLS* and cameras in Groups I to VII, unless otherwise noted. First, consult the camera group table to see which group your camera belongs to. Then as you read the manual, you will find specific information on how to use the SB-800 with your particular camera.

*CLS: Nikon Creative Lighting System (p. 5)

Group	Camera name	TTL auto flash mode (p. 37)			
		 i-TTL	 D-TTL	 TTL	 BL *1
Cameras compatible with CLS*	D3, D2-Series, D300, D200, D80, D70-Series, D60, D50, D40-Series, F6	○	–	–	○
Digital SLRs not compatible with CLS*	D1-Series, D100	–	○	–	○
I	F5, F100, F90X/N90s, F90-Series/N90, F80-Series/N80-Series, F75-Series/N75-Series, F70-Series/N70	–	–	○	○
II	F4-Series, F65-Series/N65-Series, F-801s/N8008s, F-801/N8008, Pronea 600i/6i	–	–	○	○
III	F-601/N6006, F-601M/N6000	–	–	○	○*5
IV	F60-Series/N60, F50-Series/N50, F-401x/N5005	–	–	○	○*5
V	F-501/N2020, F-401s/N4004s, F-401/N4004, F-301/N2000	–	–	○	–
VI	FM3A, FA, FE2, FG, Nikonos V, F3-Series (with the AS-17)	–	–	○	–
VII	New FM2, FM10, FE10, F3-Series, F55-Series/N55-Series	–	–	–	–
COOLPIX cameras compatible with i-TTL	COOLPIX 8400, COOLPIX 8800, COOLPIX P5000, COOLPIX P5100	○	–	–	–

*1 : Balanced Fill-Flash. This always appears together with  (p. 37).

*2 Wireless multiple flash in the i-TTL mode is possible.

*3 TTL mode is not possible with digital SLR cameras.

The SB-800's available flash modes vary, depending on the cameras and lenses in use or the camera's exposure mode and metering system. For more details, refer to "Detailed operation" (p. 35), "TTL auto flash modes available with the SB-800" (p.108) and your camera's instruction manual.

○ : Available
 - : Not available

Non-TTL auto flash mode (p. 38)		Manual mode (p. 42)			Wireless multiple flash	
AA Auto Aperture flash	A Non-TTL auto flash	GN Distance- priority manual flash	M Manual flash	RPT Repeating flash	Advanced Wireless Lighting (p. 76)	SU-4 type (master flash) (p. 84)
○	○	○	○	○	○ ^{*2}	○ ^{*3}
○	○	○ ^{*4}	○	○	-	○ ^{*3}
○	○	○	○	○	-	○
○	○	○	○	○	-	○
-	○	○	○	○	-	○
-	○	○	○	○	-	○
-	○	○	○	○	-	○
-	○	○	○	○ ^{*6}	-	○
-	○	○	○	○	-	○
○	○	○	○	-	-	-

*4 Distance-priority manual flash **GN** is not possible with D1x and D1H digital cameras.

*5 While performing Balanced Fill-Flash, no **BL** icon appears.

*6 Repeating flash is not possible with the F3-Series (using the AS-17).

Speedlight parts and their functions

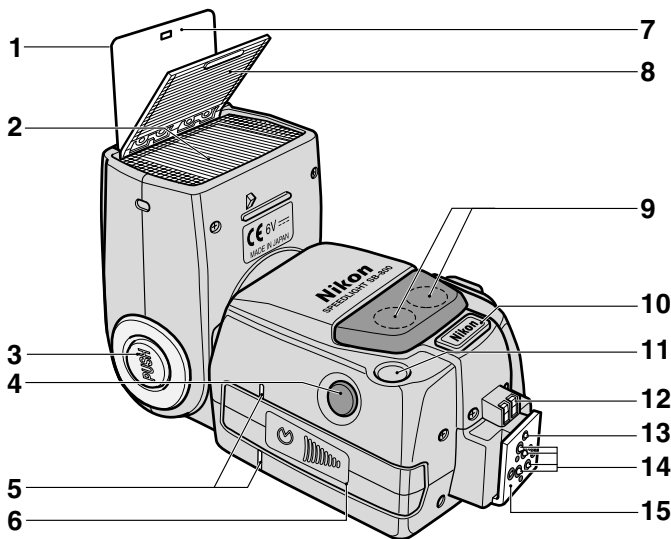

1 Control button quick reference
(p. 12)

2 Flash head (p. 100)
Can be tilted up to 90° or down to -7°, and rotated horizontally 180° to the left and 90° to the right.

3 Flash head tilting/rotating lock release button (p. 22)

4 Light sensor window for wireless remote flash (p. 74)
Setting the SB-800 as a remote flash unit (p. 76)

5 Battery chamber lid attachment indexes (p. 18)

6 Battery chamber lid (p. 18)

7 Built-in bounce card (p. 101)
Creates a highlight in the subject's eyes in bounce flash photography.

8 Built-in wide-flash adapter (p. 104)
Increases the angle of coverage to match a 14mm or 17mm lens.

9 Wide-area AF-assist illuminator
(p. 62)
Automatically turns on for autofocus operation when the light is dim.

10 External power source terminal
(supplied with cover) (p. 113)

11 Light sensor window for Non-TTL auto flash (p. 38)
Senses reflected light from the subject in Auto Aperture **[AA]** or Non-TTL auto **[A]** flash mode.

12 External AF-assist illuminator contacts (for SC-29)
Accepts optional TTL Remote Cord SC-29

13 Mount pin

14 Hot-shoe contacts

15 Mounting foot

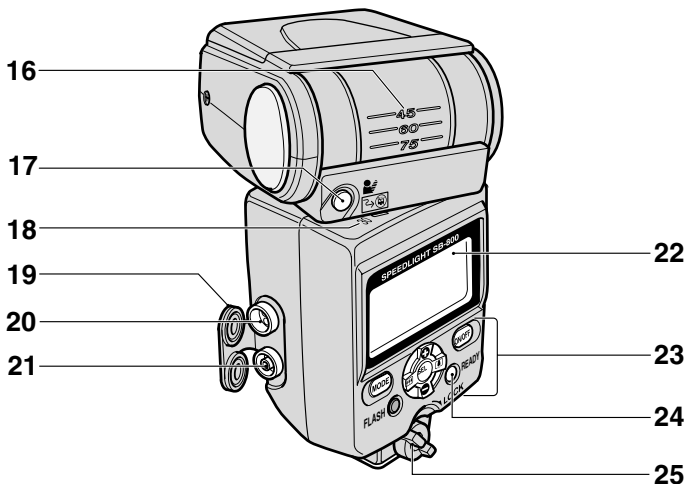

16 Flash head tilting angle scale
(p. 100)

17 Modeling illuminator button (p. 66)
Press to fire flash repeatedly to check the illumination and the shadows cast on the subject before taking pictures.

Wireless remote flash cancel button (p. 75)

The SB-800 will not fire, while this button is pressed.

18 Flash head rotating angle scale
(p. 100)

19 Terminal cover

20 TTL multiple flash terminal (p. 92)
Connects the SB-800 to the remote flash unit(s) in TTL multiple flash operation using cords.

21 Sync terminal (p. 93)
Connects the SB-800 to the sync terminal of the remote flash unit(s) in other than TTL multiple flash operation using cords.

22 LCD panel (p. 119)

23 Control buttons (p. 12)

24 Ready-light

Lights up when the SB-800 is fully recycled and ready to fire. Blinks after the SB-800 fires at its maximum output in various auto flash modes, indicating that the light may be insufficient.

25 Mounting foot lock lever (p. 22)

Control buttons

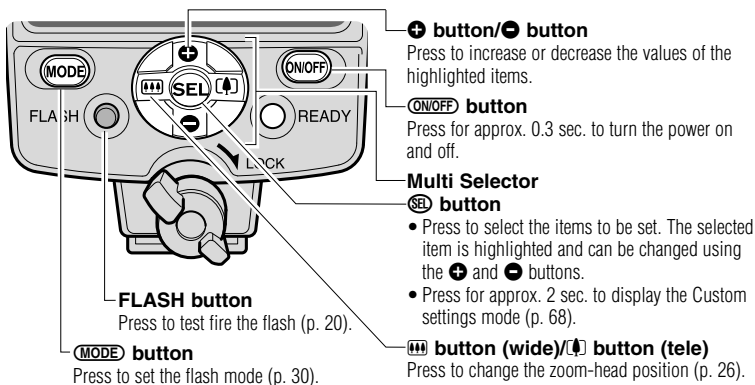

	<p>Recalling the underexposure value in the TTL auto flash mode</p> <p>Press the MODE and SEL buttons simultaneously to recall the underexposure value (p. 33).</p>
	<p>Resetting the settings</p> <p>Press the MODE and ON/OFF buttons simultaneously for approx. 2 sec. to reset all settings, including the custom settings (except the distance unit selected in m/ft) to their default values.</p>
	<p>Button lock</p> <p>Press the ON/OFF and SEL buttons simultaneously to lock the functions of the control buttons (except the ON/OFF, Modeling illuminator, and FLASH buttons) to avoid accidental malfunction. Press the buttons again to release the lock.</p>

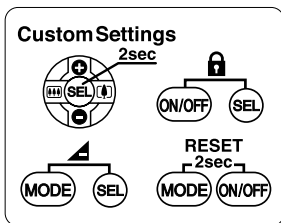

Control button quick reference

Procedures for Custom settings, recalling the underexposure value in the TTL auto flash mode, resetting all settings to their default values, and the button lock are shown in the Control button quick reference chart on the back of the built-in bounce card.

Icons on the LCD panel

Icons on the LCD panel show the status of the operations set. These icons vary depending on the settings, the combination of camera/lens, and the exposure mode.

Icons with a single flash unit

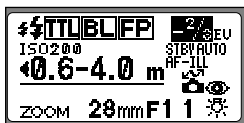





Icons when a camera compatible with CLS* is used.

	Monitor Preflashes Just before the flash fires, the SB-800 fires a series of imperceptible preflashes that are detected by the camera's TTL Multi-Sensor and analyzed for brightness and contrast (p. 36).
	TTL mode Based on the exposure control information, the camera automatically controls the flash output level to give the correct exposure (p. 37).
	Balanced Fill-Flash This always appears together with . Based on the exposure control information, the flash output level is automatically controlled for a well-balanced exposure of the main subject and background (p.37).
	Auto FP High-Speed Sync (CLS*) The SB-800 automatically fires at faster shutter speeds exceeding the camera's sync shutter speed (p. 60).

	Auto Aperture flash In addition to Non-TTL auto flash (see below), the SB-800's built-in sensor correctly controls the flash output in combination with data automatically transmitted from the camera and lens to the SB-800, including the ISO sensitivity, aperture, focal length, and exposure compensation value (p. 38).
	Non-TTL auto flash The SB-800's built-in sensor measures the flash illumination reflected back from the subject, controlling the SB-800's light output automatically to give the correct exposure (p. 40).
	Distance-priority manual flash Based on the ISO sensitivity value and aperture, the SB-800 controls the light output according to the distance value entered (p. 44).
	Manual flash The flash always fires at a specified output in combination with the aperture and light output level (p. 46).
	Repeating flash The SB-800 fires repeatedly during a single exposure, creating stroboscopic multiple-exposure effects (p. 48).

*CLS: Nikon Creative Lighting System (p. 5)

Icons on the LCD panel

	<p>Compatible with CLS (CLS*) The SB-800 is connected to cameras compatible with CLS* (p. 8).</p>	STBY Standby duration Represents the time before the standby function is activated (p. 67).
ZOOM	<p>Power zoom function The zoom-head position is automatically adjusted to match the lens focal length (p. 26).</p>	AF-ILL The wide-area AF-assist illuminator is activated The wide-area AF-assist illuminator comes on (p. 62).
ZOOM AUTO	<p>Power zoom (auto) function The zoom-head position is automatically adjusted to match the lens focal length when the SB-800 is used with COOLPIX cameras compatible with i-TTL (p. 26).</p>	NO AF-ILL The wide-area AF-assist illuminator is canceled The wide-area AF-assist illuminator does not come on (p. 62).
M ZOOM	<p>Manual zoom-head position setting You can adjust the zoom-head position manually (p. 26).</p>	AF-ILL ONLY Flash firing canceled The SB-800 does not fire but the wide-area AF-assist illuminator still comes on (p. 62).
*M ZOOM	<p>Canceling the power zoom function The power zoom is canceled, and the zoom-head position can only be adjusted manually (p. 26).</p>	 Control buttons being locked Control buttons (except the ON/OFF, Modeling illuminator and FLASH buttons) are locked (p. 12).
35mm	<p>Zoom-head position setting if the built-in wide-flash adapter is broken off accidentally The zoom-head position can be adjusted if the built-in wide-flash adapter is broken off accidentally (p. 117).</p>	 Red-eye reduction Red-eye reduction control is activated (p. 58).
ISO	<p>ISO sensitivity Represents the ISO sensitivity value (p. 24).</p>	 LCD panel illuminator Pressing any control button turns on the LCD panel illuminator (p. 119).
EV	<p>Flash output level compensation Represents the flash output level compensation value (p. 56).</p>	◀0.6 2 0▶ Beyond the flash-shooting distance range The subject is beyond the flash shooting distance range. ◀: the closest available distance, ▶: the farthest available distance (p. 30).
▲ EV	<p>Underexposure Indicates the underexposure value, showing that the light might be insufficient in the TTL auto flash mode (p. 33).</p>	

Icons with multiple flash units

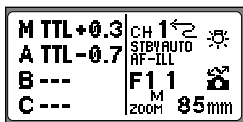

Icons in the Advanced Wireless Lighting mode

	<p>Wireless master In the wireless multiple flash mode, the SB-800 is used as the master flash unit connected to the camera (p. 72).</p>
	<p>Wireless remote In the wireless multiple flash mode, the SB-800 is set as a remote flash unit, which fires in sync with the master flash unit (p. 72).</p>
REMOTE	<p>Wireless remote In the wireless multiple flash mode, the SB-800 is set as a remote flash unit, which fires in sync with the master flash unit (p. 72).</p>
	<p>Sound monitor on When the SB-800 is set as a remote flash unit, you can monitor its operation by listening to the beeping sound (p. 89).</p>
	<p>Sound monitor canceled “Beeping” sound is off (p. 89).</p>

M	<p>Master (CLS*) Represents the settings of the flash mode and flash output level compensation value of the master unit in the Advanced Wireless Lighting mode (p. 78).</p>
A (B,C)	<p>Group A (B, C) (CLS*) Represents the settings of the flash mode and flash output level compensation value of the remote flash unit(s) in Group A (B, C) in the Advanced Wireless Lighting mode (p. 78).</p>
CH 1 2 3 4	<p>Channel (CLS*) Represents the communication channel number through which the master and remote flash units exchange data in the Advanced Wireless Lighting mode (p. 78).</p>

Highlighted items

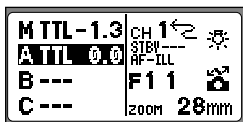

Highlighted items indicate that they can be set or changed. The highlighted items return to normal after 8 seconds unless an adjustment is made.

*CLS: Nikon Creative Lighting System (p. 5)

Lenses

In this manual, Nikkor lenses are divided into two types: CPU Nikkor lenses and non-CPU Nikkor lenses.

CPU Nikkor lenses	G-type Nikkor, D-type Nikkor, Non-G/D-type AF Nikkor (except for AF Nikkor for the F3AF), AI-P Nikkor
Non-CPU Nikkor lenses	AI-S Nikkor, AI Nikkor, Series E, etc.

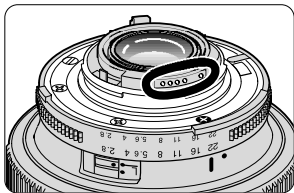

CPU lenses

CPU lenses have CPU contacts.

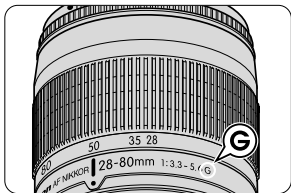

G-type Nikkor lenses

G-type Nikkor lenses send distance information to the camera body, but do not have an aperture ring. Therefore, set the aperture on the camera body. With some cameras, the usable exposure mode is limited. For more details, refer to the lens instruction manual.

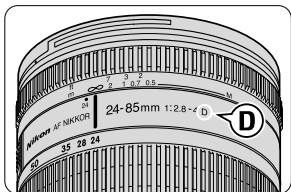

D-type Nikkor lenses

D-type Nikkor lenses send distance information to the camera body. Set the aperture either on the lens aperture ring or on the camera body. For more details, refer to the lens instruction manual.

Basic operation

In this section, basic procedures are illustrated so that you can easily perform flash photography in the TTL auto flash mode. You can easily perform flash photography by following Steps 1–8 on the left-hand pages.

In this section, basic procedures are described when a CPU lens is mounted on cameras compatible with CLS*, digital SLRs not compatible with CLS*, and cameras in Groups I to II. The SB-800's available functions and the LCD display vary depending on other camera/lens combinations.

*CLS: Nikon Creative Lighting System (p. 5)

1 Installing the batteries

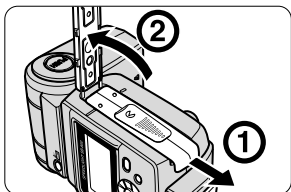

- 1** Slide open the battery chamber lid in the direction of the arrow.

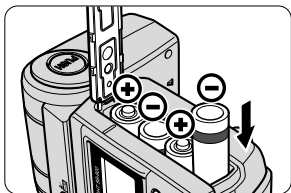

- 2** Install the batteries following the ⊕ and ⊖ marks as shown. Align the battery chamber lid attachment indexes, then close the battery chamber lid by sliding it into place while pressing down.

✔ Usable batteries

Install four AA-type penlight batteries (1.5V or lower) of any of these types:

- (1) Alkaline-manganese (1.5V) (2) Lithium (1.5V) (3) Nickel (1.5V)
(4) NiCd (rechargeable, 1.2V) (5) Ni-MH (Nickel Metal Hydride) (rechargeable, 1.2V)

- When replacing batteries, replace all four (or five when using the Quick Recycling Battery Pack SD-800) with fresh ones of the same brand.
- High-power manganese batteries are not recommended for use with the SB-800.
- Always carry extra batteries when traveling.
- For details on batteries, refer to "Notes on batteries" on page 115.

CAUTION!

- Do not use batteries not specified in this instruction manual, as this may cause them to explode, leak corrosive liquids, or catch on fire.
- Do not mix battery brands or types, or use old with new batteries. Otherwise the batteries may explode, leak corrosive liquids, or catch on fire.
- Do not recharge non-rechargeable batteries in a battery charger. Otherwise the batteries may leak corrosive liquids or generate heat.

✔ Obtaining faster recycling times using 5 batteries

Use the provided Quick Recycling Battery Pack SD-800 to install five batteries to shorten the recycling time. See page 64 for more details.

Minimum number of flashes and recycling times

When using four (or five) fresh batteries of the same type and the Speedlight fires at M1/1 output.

Batteries	Number of batteries	Min. recycling time (approx.)	Min. number of flashes/recycling time
Alkaline-manganese	x4	6.0 sec.	130 / 6-30 sec.
	x5	5.0 sec.	130 / 5-30 sec.
Lithium	x4	7.5 sec.	170 / 7.5-30 sec.
	x5	7.5 sec.	190 / 7.5-30 sec.
Nickel	x4	6.0 sec.	140 / 6-30 sec.
	x5	5.0 sec.	140 / 5-30 sec.
NiCd (1000 mAh) (rechargeable)	x4	4.0 sec.	90 / 4-30 sec.
	x5	3.5 sec.	90 / 3.5-30 sec.
Ni-MH (2000 mA) (rechargeable)	x4	4.0 sec.	150 / 4-30 sec.
	x5	2.9 sec.	150 / 2.9-30 sec.

- Minimum recycling time is for operation using fresh batteries.
- This data was measured without using the wide-area AF-assist illuminator, zoom-head position adjustment, or LCD panel illumination.
- The above data may vary due to variations in battery performance.

Replacing/recharging the batteries

Refer to the following table to determine when to replace or recharge your batteries, if the ready-light takes a long time to come on.

Type of battery	Recycling time	Remedy
Alkaline-manganese	More than 30 seconds	Replace
Lithium	More than 10 seconds	
Nickel	More than 10 seconds	
Ni-Cd (rechargeable)	More than 10 seconds	Recharge
Ni-MH (rechargeable)		

If extremely exhausted batteries are used, a strange sound can be heard caused by the flash head zooming back and forth even when the SB-800 is turned off. In this case, replace the SB-800's batteries even if an external battery source is used.

External power sources

Using an optional external power source increases the number of flash firings and provides faster recycling times (p. 113).

2 Test firing (Confirming the exposure)

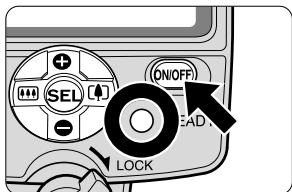

- 1 Press the **ON/OFF** button for approx. 0.3 sec. to turn on the SB-800. Make sure the ready-light comes on.

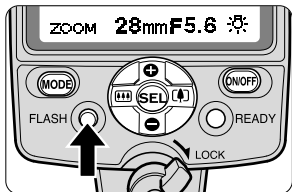

- 2 Press the **FLASH** button to test fire the flash.

Test firing

CAUTION!

When test firing the Speedlight, never position your eyes close to the flash head.

- The SB-800 fires at specified output in the Manual flash mode, or at approx. 1/16 output in the Distance-priority manual or TTL auto flash mode.
- In Auto Aperture/Non-TTL auto flash operations, the SB-800 fires at a flash output controlled by the ISO sensitivity, aperture, and zoom-head position.
- In Auto Aperture/Non-TTL auto flash operations, you can check the amount of insufficient flash output by pressing the **FLASH** button before taking the actual picture (p. 52).

ON/OFF button

Pressing the **ON/OFF** button for approx. 0.3 sec. turns the SB-800 on and the indications appear on the LCD panel. Pressing the button again turns the SB-800 off and the indications disappear.

Standby function to conserve battery power

If the SB-800 and the camera are not used for more than a specified time, the standby function activates and automatically turns the SB-800 off to conserve battery power (it goes into the standby mode).

- In the standby mode, the **STBY** indicator appears on the LCD panel.
- When in the standby mode, the SB-800 turns back on again when the SB-800's **ON/OFF** or **FLASH** button is pressed, or the shutter release button is lightly pressed (when using a camera body that is compatible with TTL auto flash) (p. 8).
- In the Wireless flash mode, the standby function activates in approx. 40 seconds (default setting) when the SB-800 is used as the master flash unit. However, the standby function does not work regardless of the SB-800's setting when the Speedlight is used as a remote flash unit (p. 73).
- If the ready-light does not come on in approx. 60 seconds after turning the power on or after the flash has fired, the SB-800 enters the standby mode regardless of the SB-800's setting.
- To avoid accidental firing or a malfunction when carrying the SB-800 in your camera bag, press the **ON/OFF** button to turn the flash unit off and make sure the **STBY** indicator disappears.

Adjusting the time before the SB-800 goes into the standby mode

Adjust this duration using Custom settings (p. 67).

3 Attach the SB-800 to the camera and

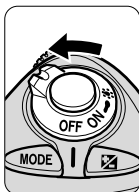

- 1** Make sure the SB-800 and the camera body are turned off.

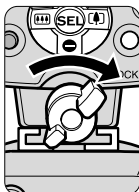
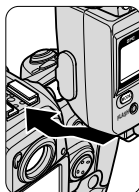

- 2** Rotate the mounting foot lock lever to the left, slide the SB-800's mounting foot into the camera's accessory shoe and turn the lock lever to the right.

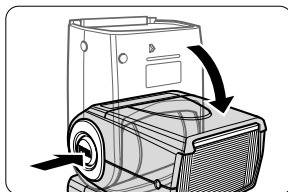

- 3** Hold down the flash head tilting/rotating lock release button to adjust the flash head to the horizontal/front position.

☑ Turn the mounting foot lock lever securely until it stops

To lock the Speedlight in place, turn the lock lever approx. 90° clockwise until it stops. To unlock, turn the lever counterclockwise until it stops.

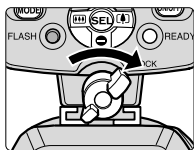

Lock

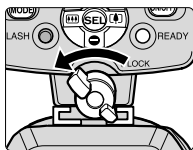

Unlock

adjust the flash head

Warning indication

If the flash head is not adjusted to the horizontal/front position, when the power is turned on, this warning appears on the LCD panel. See page 100 for the flash head's rotating angle.

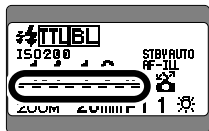

- A dotted line below the underbar appears when the flash head is tilted down -7° .



- The flash shooting distance range disappears if the flash head is adjusted to other than the horizontal/front or down -7° position.

In this manual, the sensitivity for digital SLRs and the film speed for film-based cameras are generally referred to as ISO sensitivity.

For cameras compatible with CLS, digital SLRs not compatible with CLS, cameras in Groups I to II, and COOLPIX cameras compatible with i-TTL, the ISO sensitivity is automatically set and appears on the LCD panel when the camera and SB-800 are turned ON.

Available ISO sensitivity in TTL auto flash operation

The SB-800's maximum ISO sensitivity range usable in the TTL auto flash mode is ISO 25 to 1000.

- The ISO sensitivity range may become narrower, depending on the cameras in use. For details, see your camera instruction manual.
- The flash shooting distance range on the SB-800's LCD panel varies, depending on the ISO sensitivity. Therefore, be sure to set the ISO sensitivity correctly.

Digital data communication with the SB-800

When the SB-800 is used with cameras compatible with CLS, digital SLRs not compatible with CLS, cameras in Groups I to II, or COOLPIX cameras compatible with i-TTL, digital data communication is performed. The camera automatically sends the ISO sensitivity to the SB-800. With a CPU lens, the aperture and focal length are automatically set on the SB-800 (except for COOLPIX cameras compatible with i-TTL).

Notes on setting the Speedlight's ISO sensitivity

In the TTL auto flash mode and Manual flash mode (except Distance-priority manual **GN** flash), there is no direct connection between setting the ISO sensitivity on the Speedlight and controlling the flash output level. Setting the ISO sensitivity is for correctly displaying the flash shooting distance range or the shooting distance indication on the Speedlight's LCD panel.

In the Non-TTL auto flash mode (Auto Aperture flash **AA**/Non-TTL auto flash **A**) and Distance-priority manual **GN** flash operation, the correct exposure can be obtained by setting the camera's ISO sensitivity on the Speedlight, because the Speedlight controls the flash output. For cameras compatible with CLS, digital SLRs not compatible with CLS, cameras in Groups I to II and COOLPIX cameras compatible with i-TTL, the ISO sensitivity is automatically transferred from the camera to the Speedlight.

■ Setting the ISO sensitivity for cameras in Groups III to VII

For cameras in Groups III to VII, set the ISO sensitivity in the Custom settings mode (p. 67).

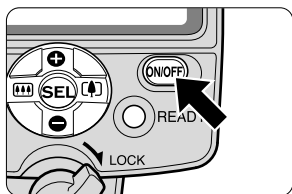



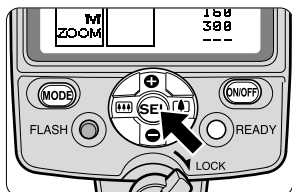

- 1 Turn the SB-800 off once, then turn it back on. After that, turn on the camera body.

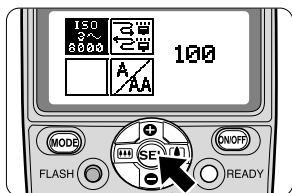



- 2 Press the  button for approx. 2 sec. to display the Custom settings mode.

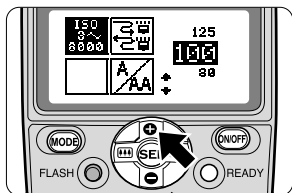

- 3 Press the / button and  button to select "ISO", then press the  button.



- 4 Press the  or  button to highlight the preferred ISO sensitivity.

- 5 Press the  button for approx. 2 sec. or press the  button to return to the normal display.

5

Adjust the zoom-head position

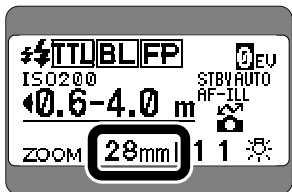

1 The zoom-head position is indicated on the LCD panel.

- The zoom-head position is automatically adjusted by the power zoom function or it can be manually adjusted.
- The guide number indicating flash output level varies according to the zoom-head position (p. 43).

The power zoom function

When the SB-800 is used with cameras compatible with CLS, digital SLRs not compatible with CLS, and cameras in Groups I to II in combination with a CPU lens, the power zoom function activates and the zoom head is automatically adjusted.

- The zoom-head position is automatically adjusted within the range of 24mm, 28mm, 35mm to 105mm in increments of 5mm between 35mm and 105mm when the power zoom function is activated.
- When the lens focal length is not one of those indicated above, the zoom head adjusts to the closest wideangle setting of the lens in use. For example, if the zoom setting of a CPU lens is between 36mm and 39mm, the zoom-head position is adjusted to 35mm.
- If a small **M** does not appear above the "ZOOM" indication on the LCD panel, the zoom-head position will be automatically adjusted. If a small **M** appears, press the **[M]** or **[L]** button several times until it disappears.

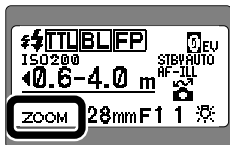

Power zoom activated

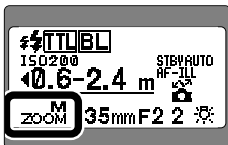

Power zoom canceled

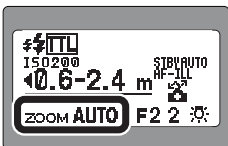

When the SB-800 is used with COOLPIX cameras compatible with i-TTL

The zoom-head position is automatically adjusted by the power zoom function. "AUTO" appears along with "ZOOM", but without a zoom-head position on the LCD panel.



■ Setting the zoom-head position manually



When the SB-800 is used with cameras in Groups III to VII in combination with a non-CPU lens, or you want to change the zoom-head position to one that does not match the focal length, you should adjust the zoom-head position manually.

- Press the  button to move toward a wideangle setting and the  button to move toward a telephoto setting.
- A small **M** above the "ZOOM" indication appears on the LCD panel while manually setting the zoom-head position.
- When the camera/lens combination is compatible with the power zoom function, the zoom-head position changes as follows, when a 35mm lens is attached:
M24mm ↔ M28mm ↔ 35mm ↔ M50mm ↔ M70mm ↔ M85mm ↔ M105mm
- Generally, set the zoom-head position to the focal length of the lens in use or to the closest wideangle setting. For example, select the 50mm setting when using a 60mm lens.

■ Canceling the power zoom function using Custom settings



The power zoom function can be canceled in the Custom settings mode (p. 67).

When the power zoom function is canceled, the zoom-head can be manually adjusted, but the zoom-head position indicator does not change even if the lens is zoomed, a lens is changed, or the  button is pressed.

- When the power zoom function is canceled, a small ***M** appears on the LCD panel.
- Press the  button to move toward a wideangle setting and the  button to move toward a telephoto setting. The zoom-head position changes as follows:
24mm ↔ 28mm ↔ 35mm ↔ 50mm ↔ 70mm ↔ 85mm ↔ 105mm

■ Using the built-in wide-flash adapter/Nikon Diffusion Dome

Use the built-in wide-flash adapter when a 14mm to 23mm lens is mounted (p. 104).

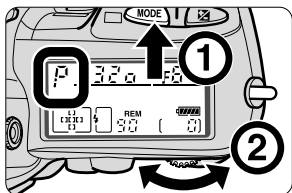

- The power zoom function becomes inactive when using the wide-flash adapter. Press the  or  button to adjust the zoom-head position to 14mm or 17mm.
- The zoom-head position is automatically set at 14mm when the Nikon Diffusion Dome is attached (p. 101).
- Generally, when using a 14mm or 17mm lens, the distance between the camera and subject differs much from the center of the frame to the periphery, so the peripheral area might not be sufficiently lit in some cases. The same is true when using the Nikon Diffusion Dome.

6 Setting the camera's exposure mode and

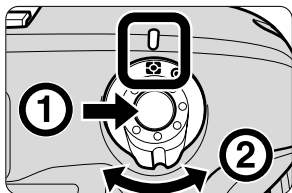

- 1 Set the camera's exposure mode to Programmed Auto (P).
 - If Programmed Auto (P) cannot be set, select another exposure mode. See the opposite page.



- 2 Set the camera's metering system to Matrix Metering .
 - If Matrix Metering  cannot be set, select Center-Weighted Metering .

Exposure mode and metering system

The camera's available exposure mode and metering system vary, depending on the cameras and lenses in use or the SB-800's flash modes. For details, refer to "Detailed operation" (p. 35), "TTL auto flash modes available with the SB-800" (p. 108) and your camera's instruction manual.

- In the Programmed Auto (P) mode, the shutter speed is automatically set to the camera's sync shutter speed, except in the Auto FP High-Speed sync mode (p. 60).

Exposure modes other than Programmed Auto exposure (P)

In Shutter-Priority Auto exposure (S) mode

By selecting a slower shutter speed, the proper exposure for the background can be achieved.

- The camera selects the correct aperture. For details, see your camera's instruction manual. However, set the shutter speed on the camera after confirming that the automatically controlled aperture will provide an appropriate shooting distance range for your subject. Refer to "Flash shooting distance range in the TTL auto flash mode" (p. 31).
- If you set a shutter speed faster than the flash sync speed, the camera automatically shifts to its fastest sync speed when the SB-800 is turned on (except in the Auto FP High-Speed sync mode) (p. 60).

In Aperture-Priority Auto exposure (A) mode

By selecting the aperture, you can control depth of field and the flash shooting distance range.

- The camera selects the correct shutter speed. For details, see your camera's instruction manual.
- To determine the aperture, refer to the "Guide number" (p. 43) and "Flash shooting distance range in the TTL auto flash modes" (p. 31).

In Manual exposure (M) mode

By selecting the shutter speed and aperture, you can control the exposure of the background, the depth of field, and the flash shooting distance range.

- If you set a shutter speed faster than the flash sync speed, the camera automatically shifts to its fastest sync speed when the SB-800 is turned on. This is true of all cameras, except mechanical shutter cameras and when using the Auto FP High-Speed sync mode (p. 60).
- To determine the aperture, refer to "Guide number" (p. 43) and "Flash shooting distance range in the TTL auto flash mode" (p. 31).

7 Setting the SB-800's flash mode

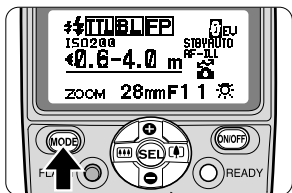

1 Press the **(MODE)** button to set the flash mode.

- Display **TTL BL** on the LCD panel.

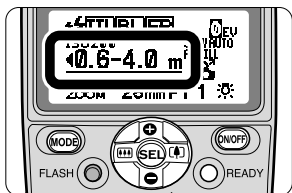

2 Confirm that the main subject is within the flash shooting distance range.

■ Selecting the flash mode

Every time you press the **(MODE)** button, the available flash mode icon changes. Refer to "Icons on the LCD panel" (p. 13).

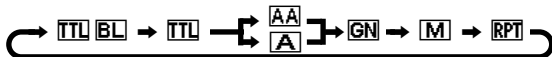

- Note that the usable flash modes only appear and vary, and the unavailable flash modes will be skipped and do not appear, when pressing the **(MODE)** button.
- The SB-800's available flash modes vary, depending on the cameras and lenses in use or the camera's exposure mode and metering system. Refer to "Detailed operation" (p. 35), "TTL auto flash modes available with the SB-800" (p. 108) and your camera's instruction manual.

■ About the flash shooting distance range

The SB-800's flash shooting distance range is 0.6m to 20m (2 to 66 ft.) and varies, depending on the ISO sensitivity, zoom-head position, and lens aperture in use.

Flash shooting distance range in the TTL auto flash mode

		ISO sensitivity								Zoom-head position (mm)										
		1600	800	400	200	100	50	25	*1	*2	14 ^{*3}	17 ^{*3}	24	28	35	50	70	85	105	
Aperture	*4																			
	2.8	2	1.4																	
	4	2.8	2	1.4																
	5.6	4	2.8	2	1.4				0.8-9.0/ 2.6-29	1.0-11/ 3.3-37	1.1-12/ 3.7-41	1.3-14/ 4.1-46	1.9-20/ 6.2-66	2.0-20/ 6.6-66	2.4-20/ 7.8-66	2.8-20/ 9.3-66	3.0-20/ 10-66	3.4-20/ 11-66	3.6-20/ 12-66	
	8	5.6	4	2.8	2	1.4			0.6-6.3/ 2.0-21	0.7-8.0/ 2.3-26	0.8-9.0/ 2.6-29	0.8-10/ 2.6-33	1.3-15/ 4.3-49	1.4-16/ 4.6-52	1.7-19/ 5.5-62	2.0-20/ 6.6-66	2.2-20/ 7.4-66	2.4-20/ 7.8-66	2.5-20/ 8.3-66	
	11	8	5.6	4	2.8	2	1.4		0.6-4.5/ 2.0-15	0.6-5.7/ 2.0-19	0.6-6.3/ 2.0-20	0.7-7.0/ 2.0-23	1.0-10/ 3.1-35	1.0-11/ 3.3-37	1.2-13/ 3.9-44	1.4-16/ 4.6-52	1.6-18/ 5.2-59	1.7-19/ 5.5-62	1.8-20/ 5.8-66	
	16 ^{*5}	11	8	5.6	4	2.8	2		0.6-3.2/ 2.0-10	0.6-4.0/ 2.0-13	0.6-4.5/ 2.0-14	0.6-5.0/ 2.0-16	0.7-5.5/ 2.2-25	0.7-8.0/ 2.3-26	0.8-9.5/ 2.8-31	1.0-11/ 3.3-37	1.1-13/ 3.7-42	1.2-13/ 3.9-44	1.3-14/ 4.1-47	
	22	16	11	8	5.6	4	2.8		0.6-2.2/ 2.0-7.4	0.6-2.8/ 2.0-9.3	0.6-3.1/ 2.0-10	0.6-3.5/ 2.0-11	0.6-5.3/ 2.0-17	0.6-5.7/ 2.0-19	0.6-6.7/ 2.0-22	0.7-7.6/ 2.3-26	0.8-9.0/ 2.6-29	0.8-9.5/ 2.8-31	0.9-10/ 2.9-33	
	32	22	16	11	8	5.6	4		0.6-1.6/ 2.0-5.2	0.6-2.0/ 2.0-6.6	0.6-2.2/ 2.0-7.3	0.6-2.5/ 2.0-8.2	0.6-3.7/ 2.0-12	0.6-4.0/ 2.0-13	0.6-4.8/ 2.0-16	0.6-5.3/ 2.0-19	0.6-6.3/ 2.0-21	0.6-6.7/ 2.0-22	0.6-7.1/ 2.1-23	
			32	22	16	11	8	5.6		0.6-1.1/ 2.0-3.7	0.6-1.4/ 2.0-4.6	0.6-1.6/ 2.0-5.2	0.6-1.8/ 2.0-5.8	0.6-2.6/ 2.0-8.7	0.6-2.8/ 2.0-9.3	0.6-3.4/ 2.0-11	0.6-4.0/ 2.0-13	0.6-4.5/ 2.0-15	0.6-4.8/ 2.0-16	0.6-5.0/ 2.0-17
				32	22	16	11	8		0.6-0.8/ 2.0-2.6	0.6-1.0/ 2.0-3.3	0.6-1.1/ 2.0-3.7	0.6-1.2/ 2.0-4.1	0.6-1.8/ 2.0-6.2	0.6-2.0/ 2.0-6.6	0.6-2.4/ 2.0-7.8	0.6-2.8/ 2.0-9.3	0.6-3.2/ 2.0-10	0.6-3.4/ 2.0-11	0.6-3.6/ 2.0-12
					32	22	16	11		-	0.6-0.7/ 2.0-2.3	0.6-0.7/ 2.0-2.9	0.6-0.8/ 2.0-3.7	0.6-1.3/ 2.0-4.4	0.6-1.4/ 2.0-4.6	0.6-1.7/ 2.0-5.5	0.6-2.0/ 2.0-6.6	0.6-2.2/ 2.0-7.4	0.6-2.4/ 2.0-7.8	0.6-2.5/ 2.0-8.3
						32	22	16		-	-	-	-	0.6-0.9/ 2.0-3.1	0.6-1.0/ 2.0-3.3	0.6-1.2/ 2.0-3.9	0.6-1.4/ 2.0-4.6	0.6-1.6/ 2.0-5.2	0.6-1.7/ 2.0-5.5	0.6-1.8/ 2.0-5.8

Flash shooting distance range (m/ft.)

*1 With the Nikon Diffusion Dome attached and the wide-flash adapter in place

*2 With the Nikon Diffusion Dome attached

*3 With the wide-flash adapter in place

*4 TTL auto flash operation is not possible at this ISO sensitivity. For ISO 1000, use an aperture 2/3 of an f/stop smaller than the aperture for ISO 1600, or 1/3 larger than the aperture for ISO 800.

*5 ■ Programmed TTL Auto Flash with the F-501/N2020, F-401s/N4004s, F-401/N4004, and F-301/N2000. (ISO 25 to ISO 400 for the F-401s and F-401/N4004)

8 Compose the picture and shoot with flash

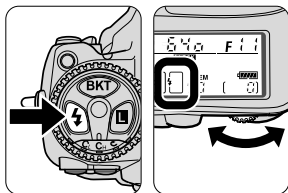

- 1 Confirm the camera's sync mode.
 - For normal flash photography, use the camera's Front-curtain sync mode.

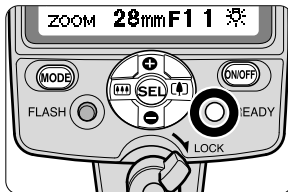

- 2 Compose the picture, confirm that the ready-light on the SB-800 or in the camera's viewfinder is on, then shoot.

✔ Set the camera's flash sync mode to Front-curtain sync.

With cameras featuring a Rear-curtain sync flash mode, make sure the camera's flash sync mode is set to Front-curtain sync.

- For other flash sync modes, refer to "Slow-sync flash" (p. 58), "Red-eye reduction with slow-sync flash mode" (p. 58), or "Rear-curtain sync" (p. 59).
- Refer to the camera's instruction manual for details on the flash sync mode.

☑ If the ready-light blinks after shooting, the light might be insufficient for correct exposure.

In the TTL auto and Non-TTL auto flash modes, when the flash has fired at its maximum output and underexposure may have occurred, the ready-lights on the SB-800 and in the camera's viewfinder blink for approx. 3 sec. Depending on the camera in use, the ready-light on the SB-800 or in the camera's viewfinder lights up. To compensate, use a wider aperture or move closer to the subject and reshoot.

Display of the amount of underexposure

For cameras compatible with CLS, digital SLRs not compatible with CLS, cameras in Group I and COOLPIX cameras compatible with i-TTL in the TTL auto flash mode, the amount of underexposure (0 to -3.0 EV) appears for approx. 3 sec on the SB-800's LCD panel; at the same time the above ready-lights blink.

- Pressing the **(MODE)** and **(SEL)** buttons simultaneously recalls this display.

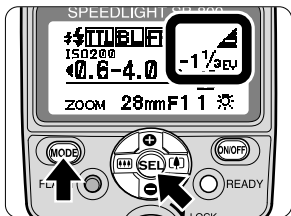

Using the SB-800 with the COOLPIX



For COOLPIX cameras, such as the COOLPIX 8800 and 4500, **having an accessory shoe (hot-shoe) or TTL multiple flash terminal:** When more powerful illumination is required or when performing multiple flash, it is recommended to connect the SB-800 or another Nikon Speedlight compatible with TTL auto flash to the COOLPIX. Auto flash operation is possible by setting the SB-800's flash mode to TTL auto flash. The flash output level is controlled by detecting signals from the camera to determine when to start and stop firing. This is controlled by Standard i-TTL flash operation with COOLPIX cameras compatible with i-TTL and by Non-TTL operation with other COOLPIX cameras.

- For connection to COOLPIX cameras featuring hot shoe contacts such as the COOLPIX 8800, attach the Speedlight directly to the accessory shoe.
- Optional accessories such as the Multi-Flash Bracket Unit SK-E900 should be used for connection with COOLPIX cameras having a TTL multiple flash terminal but no hot-shoe contacts.
- For details, see your camera's instruction manual.

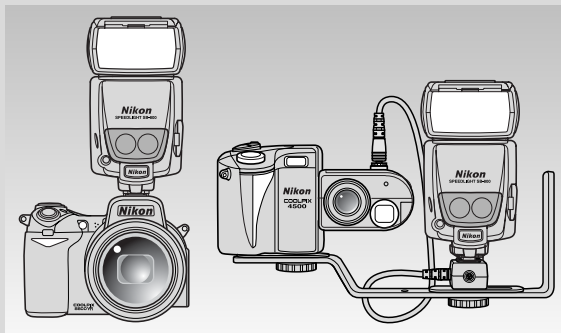

Please note that wireless multiple flash using the COOLPIX's built-in flash as a master flash unit and the SB-800 as a remote flash unit cannot be performed.

Detailed operation

This section provides a variety of flash modes available with the SB-800.

Be sure to refer to your camera's instruction manual for specific information on camera settings and functions.

SB-800's available flash modes

The SB-800's available flash modes vary, depending on the cameras and lenses in use or the camera's exposure mode. Using the TTL auto flash mode is recommended for normal flash photography.

■ Available flash modes (Indicators, usable cameras)

TTL auto flash mode

- i-TTL mode: **TTL** **BL**/**TTL**: Cameras compatible with CLS, COOLPIX cameras compatible with i-TTL
- D-TTL mode: **TTL** **BL**/**TTL**: Digital SLRs not compatible with CLS
- TTL (film based) mode: **TTL** **BL**/**TTL**: Cameras in Groups I to VI (No **BL** appears with cameras in Groups III and IV while performing Balanced Fill-Flash)

Non-TTL auto flash mode

- Auto Aperture flash: **AA** (p. 38): Cameras compatible with CLS, digital SLRs not compatible with CLS, cameras in Groups I to II and COOLPIX cameras compatible with i-TTL
- Non-TTL auto flash: **A** (p. 40): No limitation

Manual mode

- Distance-priority manual flash: **GN** (p. 44): Except D1x and D1H digital cameras.
- Manual flash: **M** (p. 46): No limitation
- Repeating flash: **RPT** (p. 48): Except COOLPIX cameras compatible with i-TTL

📷 Monitor Preflashes

The SB-800 fires a series of imperceptible Monitor Preflashes just before the flash fires to obtain information on the subject in these cases:

- (1) when the SB-800 is used with cameras compatible with CLS, digital SLRs not compatible with CLS, cameras in Group I with a CPU lens, and COOLPIX cameras compatible with i-TTL, and flash mode is set to TTL auto flash, and
- (2) when the SB-800 is used with cameras compatible with CLS with a CPU lens, and the flash mode is set to Auto Aperture flash.

Monitor Preflashes are fired instantaneously and cannot be differentiated from the main flash, but **⚡** appears on the LCD panel (using a single flash unit). However, for cameras in Group I, Monitor Preflashes are not fired when the SB-800's flash head is adjusted to other than the horizontal/front or down to -7° position, or the camera's flash sync mode is set to Rear-curtain sync, even when **⚡** appears on the LCD panel.

TTL auto flash mode

■ ■ ■ TTL auto flash: **TTL**

In this mode, the flash illumination that is reflected back from the subject is detected by the camera's TTL auto flash sensor and the camera automatically controls the flash output level to give the correct exposure.

Automatic Balanced Fill-Flash: **TTL BL**

Press the **(MODE)** button to display **TTL BL** on the LCD panel, and Automatic Balanced Fill-Flash is performed. The flash output level is automatically adjusted for a well-balanced exposure of the main subject and background. (While performing Balanced Fill-Flash, no **BL** appears with cameras in Groups III and IV.)

- **TTL BL** indicates "i-TTL Automatic Balanced Fill-Flash" in the i-TTL mode.

Standard TTL flash: **TTL**

Press the **(MODE)** button to display **TTL** on the LCD panel, and Standard TTL flash is performed. The main subject is correctly exposed regardless of the background brightness. This is useful when you want to highlight the main subject.

- **TTL** indicates "Standard i-TTL flash" in the i-TTL mode, "Standard TTL flash for Digital SLRs" in the D-TTL mode, and "Standard TTL flash" in the TTL (film-based) mode.

🔍 Notes on TTL mode indicators

Comparison tables are provided on pages 108-110 to show the SB-800's TTL mode indicators and the corresponding ones used in the instruction manuals of Speedlights featuring no CLS.

- For details on shooting procedures in the TTL auto flash mode, refer to "Basic operation" (p. 17).

🔍 Flash shooting in the 1/300 TTL High-Speed Flash sync mode (F5 only)

The farthest flash shooting distance cannot be read on the SB-800's LCD panel. In this case, use the guide number table and equation (p. 106) for calculating this distance, according to each zoom-head position.

📌 Difference in flash control level in TTL and Non-TTL auto flash mode

In either flash mode, the flash illumination that is reflected back from the subject is measured to control the flash output level. In the TTL mode, this measurement is made through-the-lens, while in the Non-TTL auto flash mode, it is performed through the Speedlight's light sensor window for Non-TTL auto flash covering a limited range. Therefore, if you take the same subject in different flash modes, some difference in the flash control level might appear, depending on shooting conditions. Use of the TTL mode is recommended when taking pictures with cameras compatible with TTL auto flash.

Non-TTL auto flash mode

Auto Aperture **AA** flash

The SB-800's built-in sensor measures the flash illumination reflected from the subject and controls the flash output in combination with data automatically transmitted from the camera and lens to the SB-800, including the ISO sensitivity value and exposure compensation value as well as the aperture and focal length of the lens.

- Auto Aperture flash is available with cameras compatible with CLS, digital SLRs not compatible with CLS, cameras in Groups I and II when used with a CPU lens, and COOLPIX cameras compatible with i-TTL.
- Auto Aperture flash is automatically set (default setting) for the above camera/lens combinations. To cancel Auto Aperture flash and set to Non-TTL auto flash (p. 40), use Custom settings (p. 67).

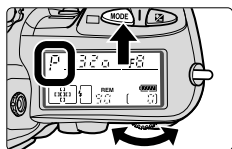

- 1** Set the camera's exposure mode to Programmed Auto (**P**) or Aperture-Priority Auto (**A**).
 - If "FEE" appears on the camera's LCD panel while the camera's exposure mode is set to Programmed Auto (P), reset the exposure mode to Aperture-Priority Auto (A).



- 2** Lock the CPU lens aperture at its minimum.
 - Not necessary with a G-type lens.

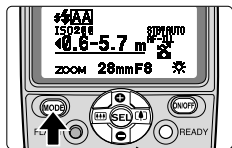

- 3** Press the **MODE** button to display **AA** on the LCD panel.

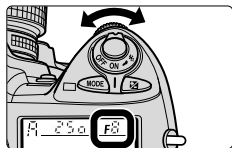

- 4** While looking at the flash shooting distance range on the SB-800's LCD panel, set the aperture on the camera when the camera's exposure mode is set to "A".
 - Making exposure compensation on the SB-800 is also possible (p. 56).

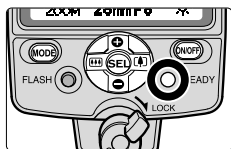

5 Compose the picture, confirm that the ready-light is on, then shoot.

- When the flash has fired at its maximum output and underexposure may have occurred, the ready-light on the SB-800 blinks for approx. 3 sec. To compensate, use a wider aperture or move closer to the subject and reshoot.

Setting the aperture in Auto Aperture **AA** flash operation

Set the aperture on the camera or lens within the available range as shown in the table below.

Usable flash shooting distance ranges in Auto Aperture flash operation

		ISO sensitivity							Zoom-head position (mm)										
		1600	800	400	200	100	50	25	*1	*2	14 ⁺³	17 ⁺³	24	28	35	50	70	85	105
Aperture	8	5.6	4	2.8	2	1.4		0.6-6.3/ 2.0-21	0.7-8.0/ 2.3-26	0.8-9.0/ 2.6-29	0.8-10/ 2.6-33	1.3-15/ 4.3-49	1.4-16/ 4.6-52	1.7-19/ 5.5-62	2.0-20/ 6.6-66	2.2-20/ 7.4-66	2.4-20/ 7.8-66	2.5-20/ 8.3-66	
	11	8	5.6	4	2.8	2	1.4	0.6-4.5/ 2.0-15	0.6-5.7/ 2.0-19	0.6-6.3/ 2.0-20	0.7-7.0/ 2.0-23	1.0-10/ 3.1-35	1.0-11/ 3.3-37	1.2-13/ 3.9-44	1.4-16/ 4.6-52	1.6-18/ 5.2-59	1.7-19/ 5.5-62	1.8-20/ 5.8-66	
	16	11	8	5.6	4	2.8	2	0.6-3.2/ 2.0-10	0.6-4.0/ 2.0-13	0.6-4.5/ 2.0-14	0.6-5.0/ 2.0-16	0.7-7.5/ 2.2-25	0.7-8.0/ 2.3-26	0.8-9.5/ 2.8-31	1.0-11/ 3.3-37	1.1-13/ 3.7-42	1.2-13/ 3.9-44	1.3-14/ 4.1-47	
	22	16	11	8	5.6	4	2.8	0.6-2.2/ 2.0-7.4	0.6-2.8/ 2.0-9.3	0.6-3.1/ 2.0-10	0.6-3.5/ 2.0-11	0.6-5.3/ 2.0-17	0.6-5.7/ 2.0-19	0.6-6.7/ 2.0-22	0.7-7.6/ 2.3-26	0.8-9.0/ 2.6-29	0.8-9.5/ 2.8-31	0.9-10/ 2.9-33	
	32	22	16	11	8	5.6	4	0.6-1.6/ 2.0-5.2	0.6-2.0/ 2.0-6.6	0.6-2.2/ 2.0-7.3	0.6-2.5/ 2.0-8.2	0.6-3.7/ 2.0-12	0.6-4.0/ 2.0-13	0.6-4.8/ 2.0-16	0.6-5.3/ 2.0-19	0.6-6.3/ 2.0-21	0.6-6.7/ 2.0-22	0.6-7.1/ 2.1-23	
		32	22	16	11	8	5.6	0.6-1.1/ 2.0-3.7	0.6-1.4/ 2.0-4.6	0.6-1.6/ 2.0-5.2	0.6-1.8/ 2.0-5.8	0.6-2.6/ 2.0-8.7	0.6-2.8/ 2.0-9.3	0.6-3.4/ 2.0-11	0.6-4.0/ 2.0-13	0.6-4.5/ 2.0-15	0.6-4.8/ 2.0-16	0.6-5.0/ 2.0-17	
			32	22	16	11	8	0.6-0.8/ 2.0-2.6	0.6-1.0/ 2.0-3.3	0.6-1.1/ 2.0-3.7	0.6-1.2/ 2.0-4.1	0.6-1.8/ 2.0-6.2	0.6-2.0/ 2.0-6.6	0.6-2.4/ 2.0-7.8	0.6-2.8/ 2.0-9.3	0.6-3.2/ 2.0-10	0.6-3.4/ 2.0-11	0.6-3.6/ 2.0-12	
				32	22	16	11	-	0.6-0.7/ 2.0-2.3	0.6-0.7/ 2.0-2.6	0.6-0.8/ 2.0-2.9	0.6-1.3/ 2.0-4.4	0.6-1.4/ 2.0-4.6	0.6-1.7/ 2.0-5.5	0.6-2.0/ 2.0-6.6	0.6-2.2/ 2.0-7.4	0.6-2.4/ 2.0-7.8	0.6-2.5/ 2.0-8.3	
					32	22	16	-	-	-	-	0.6-0.9/ 2.0-3.1	0.6-1.0/ 2.0-3.3	0.6-1.2/ 2.0-3.9	0.6-1.4/ 2.0-4.6	0.6-1.6/ 2.0-5.2	0.6-1.7/ 2.0-5.5	0.6-1.8/ 2.0-5.8	

Flash shooting distance range (m/ft.)

*1 With the Nikon Diffusion Dome attached and the wide-flash adapter in place

*2 With the Nikon Diffusion Dome attached

*3 With the wide-flash adapter in place

- For example, for an ISO sensitivity of 100, with the zoom-head position adjusted to 35mm, and the subject at a distance of 5m (16.4 ft.), selecting an aperture of f/2 to f/5.6 from the table gives the correct exposure.

Notes on using a telephoto lens in the Non-TTL auto flash mode

When you shoot a distant subject using a telephoto lens in Auto Aperture **AA** or Non-TTL auto **A** flash operation, underexposure may occur even though the subject is within the usable flash shooting distance range. Use of the TTL mode is recommended when taking pictures with cameras compatible with TTL auto flash.

Non-TTL auto flash mode

Non-TTL auto **A** flash

The SB-800's built-in sensor measures the flash illumination reflected from the subject, automatically controlling the SB-800's light output to give the correct exposure. This allows you to make exposure compensation (p. 54) easily by varying the aperture set on the camera or lens.

- No limitation on usable cameras.
- Auto Aperture flash (p. 38) is automatically set (default setting) when the SB-800 is used with cameras compatible with CLS, digital SLRs not compatible with CLS, cameras in Groups I and II in combination with a CPU lens, and COOLPIX cameras compatible with i-TTL. To cancel Auto Aperture flash and set to Non-TTL auto flash, use Custom settings (p. 67).

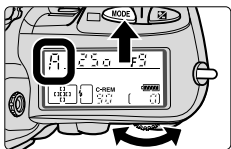

- 1 Set the camera's exposure mode to Aperture-Priority Auto (**A**) or Manual (**M**).

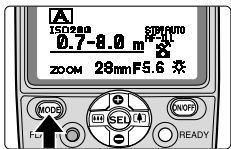

- 2 Press the **MODE** button to display **A** on the LCD panel.



- 3 Press the **+** or **-** button to change the aperture, bringing the subject within the flash shooting distance range.

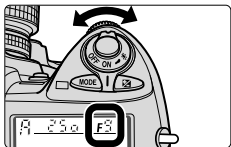

- 4 Set the aperture that appears on the SB-800's LCD panel on the lens or camera.

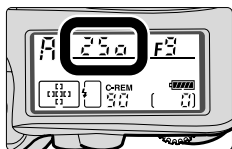

5 Set the camera to its highest flash sync shutter speed.

- For details, see your camera's instruction manual.

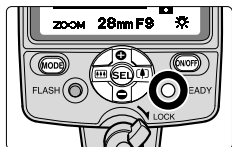

6 Compose the picture, make sure the ready-light is on, then shoot.

- When the flash has fired at its maximum output and underexposure may have occurred, the ready-light on the SB-800 blinks for approx. 3 sec. To compensate, use a wider aperture or move closer to the subject and reshoot.

■ Setting the aperture in Non-TTL auto **A** flash operation

Set the aperture within the available range as shown in the table below.

Usable flash shooting distance ranges in Non-TTL auto flash operation

		ISO sensitivity							Zoom-head position (mm)										Flash shooting distance range (m/ft.)	
		1600	800	400	200	100	50	25	*1	*2	14 ⁺³	17 ⁺³	24	28	35	50	70	85		105
Aperture	8	5.6	4	2.8	2	1.4			0.6-6.3/ 2.0-21	0.7-8.0/ 2.3-26	0.8-9.0/ 2.6-29	0.8-10/ 2.6-33	1.3-15/ 4.3-49	1.4-16/ 4.6-52	1.7-19/ 5.5-62	2.0-20/ 6.6-66	2.2-20/ 7.4-66	2.4-20/ 7.8-66	2.5-20/ 8.3-66	
	11	8	5.6	4	2.8	2	1.4		0.6-4.5/ 2.0-15	0.6-5.7/ 2.0-19	0.6-6.3/ 2.0-20	0.7-7.0/ 2.0-23	1.0-10/ 3.1-35	1.0-11/ 3.3-37	1.2-13/ 3.9-44	1.4-16/ 4.6-52	1.6-18/ 5.2-59	1.7-19/ 5.5-62	1.8-20/ 5.8-66	
	16	11	8	5.6	4	2.8	2		0.6-3.2/ 2.0-10	0.6-4.0/ 2.0-13	0.6-4.5/ 2.0-14	0.6-5.0/ 2.0-16	0.7-7.5/ 2.2-25	0.7-8.0/ 2.3-26	0.8-9.5/ 2.8-31	1.0-11/ 3.3-37	1.1-13/ 3.7-42	1.2-13/ 3.9-44	1.3-14/ 4.1-47	
	22	16	11	8	5.6	4	2.8		0.6-2.2/ 2.0-7.4	0.6-2.8/ 2.0-9.3	0.6-3.1/ 2.0-10	0.6-3.5/ 2.0-11	0.6-5.3/ 2.0-17	0.6-5.7/ 2.0-19	0.6-6.7/ 2.0-22	0.7-7.6/ 2.3-26	0.8-9.0/ 2.6-29	0.8-9.5/ 2.8-31	0.9-10/ 2.9-33	
	32	22	16	11	8	5.6	4		0.6-1.6/ 2.0-5.2	0.6-2.0/ 2.0-6.6	0.6-2.2/ 2.0-7.3	0.6-2.5/ 2.0-8.2	0.6-3.7/ 2.0-12	0.6-4.0/ 2.0-13	0.6-4.8/ 2.0-16	0.6-5.3/ 2.0-19	0.6-6.3/ 2.0-21	0.6-6.7/ 2.0-21	0.6-7.1/ 2.1-23	
			32	22	16	11	8	5.6		0.6-1.1/ 2.0-3.7	0.6-1.4/ 2.0-4.6	0.6-1.6/ 2.0-5.2	0.6-1.8/ 2.0-5.8	0.6-2.6/ 2.0-8.7	0.6-2.8/ 2.0-9.3	0.6-3.4/ 2.0-11	0.6-4.0/ 2.0-13	0.6-4.5/ 2.0-15	0.6-4.8/ 2.0-16	0.6-5.0/ 2.0-17
				32	22	16	11	8		0.6-0.8/ 2.0-2.6	0.6-1.0/ 2.0-3.3	0.6-1.1/ 2.0-3.7	0.6-1.2/ 2.0-4.1	0.6-1.8/ 2.0-6.2	0.6-2.0/ 2.0-6.6	0.6-2.4/ 2.0-7.8	0.6-2.8/ 2.0-9.3	0.6-3.2/ 2.0-10	0.6-3.4/ 2.0-11	0.6-3.6/ 2.0-12
					32	22	16	11		-	0.6-0.7/ 2.0-2.3	0.6-0.7/ 2.0-2.6	0.6-0.8/ 2.0-2.9	0.6-1.3/ 2.0-4.4	0.6-1.4/ 2.0-4.6	0.6-1.7/ 2.0-5.5	0.6-2.0/ 2.0-6.6	0.6-2.2/ 2.0-7.4	0.6-2.4/ 2.0-7.8	0.6-2.5/ 2.0-8.3
						32	22	16		-	-	-	-	0.6-0.9/ 2.0-3.1	0.6-1.0/ 2.0-3.3	0.6-1.2/ 2.0-3.9	0.6-1.4/ 2.0-4.6	0.6-1.6/ 2.0-5.2	0.6-1.7/ 2.0-5.5	0.6-1.8/ 2.0-5.8

*1 With the Nikon Diffusion Dome attached and the wide-flash adapter in place

*2 With the Nikon Diffusion Dome attached

*3 With the wide-flash adapter in place

- For example, for an ISO sensitivity of 100, with the zoom-head position adjusted to 35mm, and the subject at a distance of 5m (16.4 ft.), selecting apertures from f/2 to f/5.6 from the table will give the correct exposure.
- To set the aperture on Zoom-Nikkor lenses having variable maximum apertures, refer to "The flash shooting distance range with zoom lenses having a variable aperture" (p. 57).

Manual mode

Manual mode

The SB-800 features three manual modes.

- Distance-priority manual flash **GN**
- Manual flash **M**
- Repeating flash **RPT**

You can calculate the correct aperture by using the guide number table and the shooting distance. Then set the same aperture manually on the lens.

In this case, set the camera's exposure mode to Aperture-Priority Auto (**A**) or Manual (**M**).

- Refer to your camera's instruction manual for details on camera and lens aperture settings.
- With the SB-800 in the Manual mode, if the camera's exposure mode is set to other than Aperture-Priority (**A**) or Manual (**M**), the shutter may not be released, depending on the cameras in use. For details, refer to your camera's instruction manual.
- In the Manual mode, no warning ready-light blinks to indicate that the light may have been insufficient for correct exposure after shooting.

■ Determining the aperture, flash output level and shooting distance in the Manual mode

In the Manual mode, use the guide number table and the following equation to calculate the aperture, flash output level, and shooting distance to obtain the correct exposure.

- The guide number (GN at ISO 100; m/ft) indicates the amount of light generated by the flash. The larger the number, the greater the flash output.

Guide number (ISO 100, m/ft)

Flash output level	Zoom-head position (mm)										
	*1	*2	14 ^{*3}	17 ^{*3}	24	28	35	50	70	85	105
M1/1	12.5/41	16/52	17/56	19/62	30/98	32/105	38/125	44/144	50/164	53/174	56/184
M1/2	8.8/29	11.3/37	12/39	13.4/44	21.2/70	22.6/74	26.9/88	31/102	35.4/116	37.5/123	40/131
M1/4	6.3/21	8.0/26	8.5/28	9.5/31	15.0/49	16/52	19/62	22/72	25/82	26.5/87	28/92
M1/8	4.4/14	5.7/19	6.0/20	6.7/22	10.6/35	11.3/37	13.4/44	15.6/51	17.7/58	18.7/61	19.8/65
M1/16	3.1/10	4.0/13	4.3/14	4.8/16	7.5/25	8.0/26	9.5/31	11/36	12.5/41	13.3/44	14/46
M1/32	2.2/7	2.8/9	3.0/10	3.4/11	5.3/17	6.0/20	6.7/22	7.8/26	8.8/29	9.4/31	9.9/32
M1/64	1.6/5	2.0/7	2.1/7	2.4/8	3.7/12	4.0/13	4.8/16	5.5/18	6.3/21	6.6/22	7.0/23
M1/128	1.1/4	1.4/5	1.5/5	1.7/6	2.6/8.5	2.8/9	3.4/11	3.9/13	4.4/14	4.7/15	4.9/16

*1 With the Nikon Diffusion Dome attached and the wide-flash adapter in place

*2 With the Nikon Diffusion Dome attached

*3 With the wide-flash adapter in place

ISO sensitivity factors

For sensitivities other than ISO 100, multiply the guide number by the factors shown in the table below.

ISO	25	50	100	200	400	800	1600
Factors	x0.5	x0.71	x1	x1.4	x2	x2.8	x4

To calculate the correct aperture

Calculate the correct aperture by using this equation and the guide number table, according to the ISO sensitivity, shooting distance, flash output level and zoom-head position that are set:

$$\text{f/stop (aperture)} = \text{Guide number (GN at ISO 100; m/ft.)} \times \text{ISO sensitivity factor} \div \text{Shooting distance (m/ft)}$$

For example, for the ISO sensitivity of 400 (or ISO sensitivity factor: 2), with the zoom-head position adjusted to 28mm, and the flash output level set to M1/1:

- Referring to the guide number table, determine the guide number as 32/105 (m/ft.). When the shooting distance is 4m (13.1 ft.), the correct aperture value is:
 $32/105 \text{ (GN at ISO 100, m/ft.)} \times 2 \text{ (ISO sensitivity factor for ISO 400)} \div 4/13.1 \text{ (shooting distance; m/ft.)} = 16 \text{ (aperture)}$
- Set the aperture value 16 on both the SB-800 and the camera or lens.

To obtain the correct flash output level

Calculate the guide number (GN at ISO 100; m/ft.) by using this equation, according to the shooting distance and aperture required.

$$\text{Guide number (GN at ISO 100; m/ft.)} = \text{Shooting distance (m/ft)} \times \text{Aperture (f)} \div \text{ISO sensitivity factor}$$

Referring to the guide number table, determine an appropriate flash output level corresponding to the guide number obtained above, then set the same value on the SB-800. For example, for the ISO sensitivity of 400 (or ISO sensitivity factor: 2) and the shooting distance of 4m (13.1 ft) with an aperture of f/8:

$$4/13.1 \text{ (shooting distance; m/ft.)} \times 8 \text{ (aperture value)} \div 2 \text{ (ISO sensitivity factor of ISO 400)} = 16/52 \text{ (GN at ISO 100; m/ft.)}$$

- When the zoom-head position is adjusted to 28mm, set M1/4 flash output level on the SB-800, which can be obtained from GN 16/52 (m/ft.) corresponding to the zoom-head position of 28mm referring to the guide number table.
- In Distance-priority manual flash operation, the correct flash output level is automatically determined by the SB-800 according to the shooting distance, aperture and ISO sensitivity that are set.

To calculate the shooting distance

Calculate the shooting distance (m/ft.) by using this equation and the guide number table, according to the ISO sensitivity, aperture value, flash output level and zoom-head position that are set:

$$\text{Shooting distance (m/ft.)} = \text{Guide number (GN at ISO 100; m/ft.)} \times \text{ISO sensitivity factor} \div \text{Aperture (f)}$$

Distance-priority manual **GN** flash

In this flash operation, the SB-800 automatically controls the light output according to the distance value and aperture set. Enter the distance value and you can take pictures having the same exposure even when shooting at different apertures.

- Distance-priority manual flash **GN** is not possible with D1x and D1H digital cameras.
- This mode allows you to make exposure compensation by varying the flash output level compensation value (p. 56).

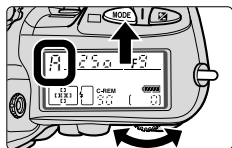

- 1** Set the camera's exposure mode to Aperture-Priority Auto (**A**) or Manual (**M**).

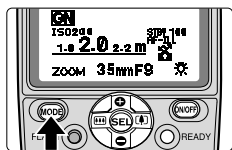

- 2** Press the **(MODE)** button to display **GN** on the LCD panel.

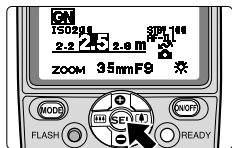

- 3** Press the **(SEL)** button to highlight the distance display, then press the **(+)** or **(-)** button to increase or decrease the distance values.
 - The usable distance range is 0.3m to 20m (1 to 65.6 ft.) and varies depending on the ISO sensitivity.

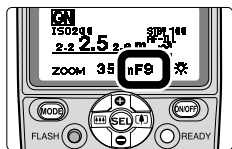

- 4** Set the aperture.
 - For cameras compatible with CLS, digital SLRs not compatible with CLS, cameras in Groups I and II with CPU lenses, and COOLPIX cameras compatible with i-TTL, set the SB-800's aperture on the camera. You cannot set the aperture on the SB-800 directly.
 - For other camera/lens combinations, press the **(SEL)** button to highlight the aperture display, then press the **(+)** or **(-)** button to increase or decrease the aperture value.

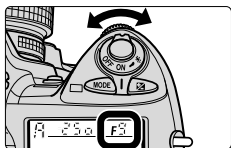

5 Set the aperture that appears on the SB-800's LCD panel on the lens or camera.

- With cameras in Groups III to VII.

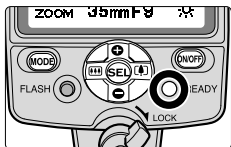

6 Confirm that the ready-light is on, then shoot.

Distance values that can be entered when performing Distance-priority manual **GN** flash operation (m/ft.)

0.3/1	0.4/1.3	0.5/1.6	0.6/2	0.7/2.3	0.8/2.6	0.9/3	1.0/3.3	1.3/4.3	1.4/4.6
1.6/5.2	1.8/5.9	2.0/6.6	2.2/7.2	2.5/8.2	2.8/9.2	3.1/10.2	3.5/11.5	4.0/13.1	4.5/14.8
5.0/16.4	5.6/18.4	6.3/20.7	7.1/23.3	8.0/26.2	9.0/29.6	10/32.8	11/36.0	13/42.7	14/45.9
16/52.5	18/59.1	20/65.6							

- Choose an appropriate flash shooting distance from the table above. If a desirable distance value is not found in the table, use a shorter distance.
For example, if the desired shooting distance is 2.7m (8.9 ft.), set 2.5m (8.2 ft.) on the LCD panel.

Beyond the flash-shooting distance range warning

In distance-priority manual flash operation, the distance exceeding the available flash shooting distance range cannot be displayed on the LCD panel. Therefore, if the available flash shooting distance range is shifted by changing the ISO sensitivity, aperture, or zoom-head position after you have set the shooting distance and aperture, the farthest (or closest) available flash shooting distance value is highlighted with an arrow pointing toward the available flash shooting distance range.

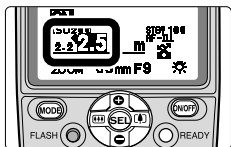

The figure shows that the farthest available flash shooting distance is 2.5m (8.2 ft.).

Manual mode

Manual **M** flash

In Manual flash photography, you select the aperture and flash output level. In this way, you can control the exposure and flash shooting distance when shooting subjects where the correct exposure is difficult to obtain in the TTL or Non-TTL auto flash mode. The flash output level can be set from M1/1 (full output) to M1/128 to match your creative preferences.

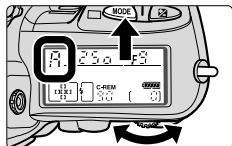

- 1 Set the camera's exposure mode to Aperture-Priority Auto (**A**) or Manual (**M**).

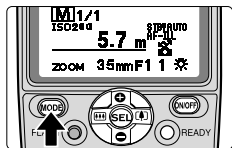

- 2 Press the **MODE** button until **M** appears on the LCD panel.

- 3 Determine the flash output level and aperture to match the flash shooting distance.

- For details on determining the flash output level and the aperture, refer to "Determining the aperture and flash output level in the Manual mode" (p. 42).

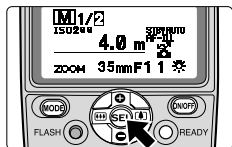

- 4 Press the **SEL** button to highlight the flash output level display, then press the **+** or **-** button to increase or decrease the values.

- Refer to "Setting the flash output level" (p. 47).

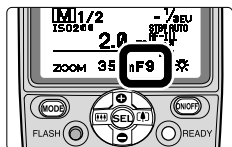

- 5 Set the aperture.

- For cameras compatible with CLS, digital SLRs not compatible with CLS, cameras in Groups I and II with CPU lenses, and COOLPIX cameras compatible with i-TTL, set the SB-800's aperture on the camera. You cannot set the aperture on the SB-800 directly.
- For other camera/lens combinations, press the **SEL** button to highlight the aperture display, then press the **+** or **-** button to increase or decrease the aperture value.
- If the ISO sensitivity is correctly set, the flash shooting distance appears on the LCD panel, matching the flash output level and aperture as set.

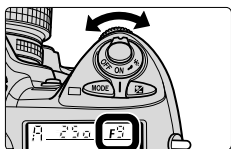

- 6** Set the same aperture on your camera or lens that is set on the SB-800.
- With cameras in Groups III to VII.

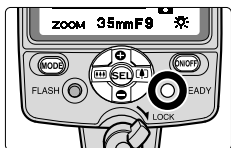

- 7** Confirm that the ready-light comes on, then shoot.

■ Setting the flash output level

Press the **SEL** button to highlight the flash output level display. The flash output level changes every time you press the **+** or **-** button as shown below.

When you press the **-** button:

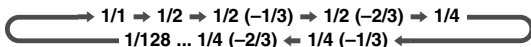

When you press the **+** button:

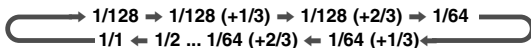

- The numbers in parentheses represent the adjustable flash output level in $\pm 1/3$ steps except between 1/1 and 1/2. Therefore, 1/32 (-1/3) and 1/64 (+2/3) represent the same flash output level.
- To extend the flash shooting distance, choose a flash output level close to M1/1.

Repeating **RPT** flash

In Repeating flash operation, the SB-800 fires repeatedly during a single exposure, creating stroboscopic multiple-exposure effects. This operation is useful when shooting fast-moving subjects.

- In this operation, **RPT** appears on the LCD panel.
- Be sure to use fresh or fully charged batteries and allow enough time for the flash to recycle between each repeating flash session.
- Also, it is recommended to use a tripod to prevent camera/flash shake, because slower shutter speeds are used.

■ Setting the flash output level, the frequency (Hz), and the number of repeating flashes per frame

- Frequency (Hz) represents the number of times the flash fires per second.
- The actual number of repeating flashes per frame becomes lower than the one set as the shutter speed increases or the number of flashes per second decreases, because the Speedlight fires during a single exposure.
- Referring to the table below, set the flash output level, the frequency, and the number of repeating flashes separately for each picture.

Maximum number of repeating flashes per frame

Frequency*	Flash output level				
	1/8	1/16	1/32	1/64	1/128
1-2 Hz	14	30	60	90	90
3 Hz	12	30	60	90	90
4 Hz	10	20	50	80	80
5 Hz	8	20	40	70	70
6 Hz	6	20	32	56	56
7 Hz	6	20	28	44	44
8 Hz	5	10	24	36	36
9 Hz	5	10	22	32	32
10 Hz	4	8	20	28	28
20-100 Hz	4	8	12	24	24

* Frequency (Hz) represents the number of flashes per second.

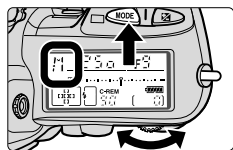

- 1 Set the camera's exposure mode to Manual (**M**).

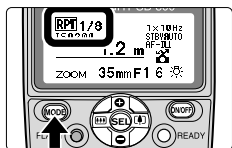

2 Press the **(MODE)** button to display **RPT**.

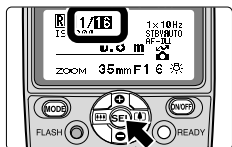

3 Press the **(SEL)** button to highlight the flash output level display, then press the **(+)** or **(-)** button to increase or decrease the values.

- The available range of the flash output level is between 1/8 and 1/128.

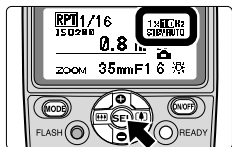

4 Press the **(SEL)** button.

- The flash output level is set, then the frequency display is highlighted.

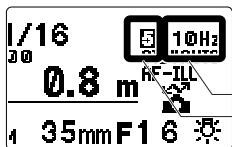

5 Repeat the procedures above to set the frequency and the number of repeating flashes per frame.

Frequency (Hz)

Number of repeating flashes per frame

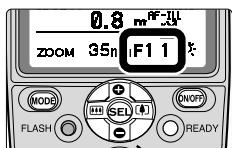

6 Determine the guide number according to the flash output level and zoom-head position set, then calculate the correct aperture from the guide number and the shooting distance. Finally set this aperture on the SB-800.

- Refer to "Guide number table" (p. 42) and "Determining the aperture and flash output level in the Manual mode" (p. 42).
- For cameras compatible with CLS, digital SLRs not compatible with CLS, cameras in Groups I and II with CPU lenses, set the SB-800's aperture on the camera. You cannot set the aperture on the SB-800 directly.
- If the ISO sensitivity is correctly set, the flash shooting distance appears on the LCD panel, matching the flash output level and aperture as set.

Manual mode

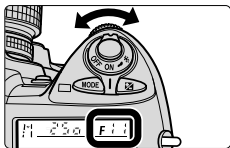

7 Set the same aperture on the camera or lens that is set on the SB-800.

- With cameras in Groups III to VII.

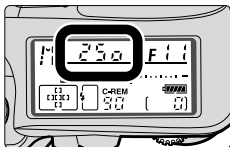

8 Set the shutter speed.

- Use the equation to determine the shutter speed and use that shutter speed or one slower.

$$\text{Shutter speed} = \text{Number of flashes per frame} \div \text{Frequency of flashes (Hz)}$$

- For example, if the number of flashes per frame is 10 and frequency is 5 Hz, divide 10 by 5 to get a shutter speed of 2 sec. or slower.
- Or you can set the shutter speed to B (bulb) to accommodate any number of repeating flashes.

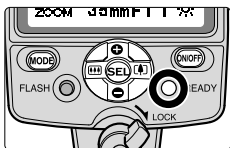

9 Confirm that the ready-light is on, then shoot.

☑ Making sure the flash fires correctly before shooting

Press the **FLASH** button to make sure the flash fires correctly as set.

☑ Exposure compensation in Repeating flash operation

The flash shooting distance calculated in step number 6 is the correct exposure for the first flash in the sequence. Therefore, repeating flash at this flash output level will result in overexposure of any overlapping images. To prevent this, set a smaller aperture on the camera.

Notes on continuous flash shooting



WARNING

Do not exceed the maximum number of continuous firings

You should allow the SB-800 to cool off for at least 10 minutes after the maximum number of continuous firings are performed as shown in the table below:

Max. number of continuous firings

Flash mode	Max. number of continuous firings (at 6 frames/sec.)
TTL auto flash	15
Non-TTL auto flash/Auto Aperture flash	
Manual flash (Flash output level: M1/1, M1/2)	
Manual flash (Flash output level: M1/4 to M1/128)	40

■ Synchronization during continuous flash shooting

It is possible to take up to the number of frames during continuous shooting as shown in the table below. However, if the continuous firings exceed the maximum numbers as shown in the table above, you should allow the SB-800 to cool off for at least 10 minutes.

Maximum number of frames during continuous flash shooting (at six frames per sec.)

Optional power source	Batteries inside SB-800	Flash output level				
		1/8	1/16	1/32	1/64	1/128
SB-800 only	All types	Up to 4	Up to 8	Up to 16	Up to 30	Up to 40
SD-7	Alkaline-manganese	Up to 6	Up to 10	Up to 40	Up to 40	Up to 40
SD-8A	Alkaline-manganese	Up to 5	Up to 10	Up to 20	Up to 40	Up to 40
	Lithium			Up to 30		
	NiCd	Up to 5	Up to 10	Up to 30	Up to 40	Up to 40
SK-6/ SK-6A	Ni-MH	Up to 5	Up to 10	Up to 20	Up to 40	Up to 40
	Alkaline-manganese					
	Lithium					
	NiCd					
SK-6/ SK-6A	Ni-MH	Up to 5	Up to 10	Up to 30	Up to 40	Up to 40
	Alkaline-manganese					
	Lithium					

- With fresh batteries of the same type in both the SB-800 and optional Nikon SD-8A or Power Bracket Unit SK-6/SK-6A.
- Refer to table "Maximum number of repeating flashes per frame" on page 48 when performing Repeating flash.

Checking the correct exposure before shooting

You can determine whether the subject will receive the correct exposure by test firing the SB-800 before actually taking the picture in TTL auto flash, Auto Aperture, and Non-TTL auto flash operations.

- In manual flash mode, checking the correct exposure cannot be performed by test firing.

■ ■ ■ TTL auto flash mode

Press the SB-800's **(MODE)** button until **[AA]** (Auto Aperture flash) or **[A]** (Non-TTL auto flash) appears on the LCD panel. Set the same aperture on the SB-800 as set in the TTL auto flash mode. Press the shutter release button slightly, then press the **FLASH** button to fire the flash. If the ready-light blinks after firing, this indicates the light may have been insufficient for correct exposure. In this case, set a wider aperture on the camera or lens, or move closer to the subject.

■ ■ ■ Auto Aperture flash

Make the necessary settings on the SB-800 and camera, press the shutter release button slightly, then press the **FLASH** button to fire the flash. If the ready-light blinks after firing, this indicates the light may have been insufficient for correct exposure. In this case, set a wider aperture on the camera or lens, or move closer to the subject.

■ ■ ■ Non-TTL auto flash

Make the necessary settings on the SB-800 and camera, then press the **FLASH** button to fire the flash. If the ready-light blinks after firing, this indicates the light may have been insufficient for correct exposure. In this case, set a wider aperture on the camera or lens, or move closer to the subject.

Other functions

Detailed information on each function of the SB-800 is provided.

Exposure compensation and flash output level

Exposure compensation allows you to take well-balanced pictures by intentionally modifying the flash exposure. This is useful when a subject of extremely high or low reflectivity is included in the scene or when you want to create flash photographs to match your creative preferences.

- Some plus compensation may be necessary when the background includes a mirror, white wall, or other highly reflective surface. Likewise, some minus compensation may be required when the background is dark or includes subjects of low reflectivity.
- Making exposure compensation for both the main subject and background, the main subject only without affecting the background, or the background only without affecting the main subject are possible, depending on the flash shooting situation.

Exposure compensation on the SB-800 can be performed in these ways:

Exposure compensation	Available flash mode	Usable camera
Making exposure compensation for both the main subject and background	All flash modes	Cameras in all groups
Making exposure compensation for the main subject only	TTL auto flash and Auto Aperture flash	Cameras compatible with CLS, digital SLRs not compatible with CLS, cameras in Groups I to III, and COOLPIX cameras compatible with i-TTL.
	Manual flash mode	Cameras in all groups
Making exposure compensation for the background only	Flash shooting at slow shutter speeds	Cameras in all groups

■ Making exposure compensation for both the main subject and background

In TTL auto flash mode and Auto Aperture flash operation

Use the camera's exposure compensation function to modify both the SB-800's flash output level and the background exposure. For details, see your camera's instruction manual.

- The exposure compensation value set on the camera is not displayed on the SB-800's LCD panel.
- Exposure compensation beyond the usable ISO sensitivity range cannot be performed (p. 24). For example, with an ISO sensitivity of 100, if you try to make an exposure compensation of +3 steps on the camera (equivalent to ISO 12), which is out of the usable ISO sensitivity range (ISO 25-1000) of the SB-800. In this case, exposure compensation up to +2 steps (equivalent to ISO 25) is possible.

Making exposure compensation in Non-TTL auto flash and Manual flash operations

Exposure compensation is performed by intentionally modifying the correct aperture.

- In the Non-TTL auto flash mode, the correct exposure can be obtained when the same aperture is set on the camera as that set on the SB-800. Therefore, to make exposure compensation, vary the aperture set on the camera while retaining the aperture set on the SB-800 or vice versa.
- In the Manual flash mode, calculate the proper aperture for the correct exposure from the guide number and the shooting distance (p. 43). Then, use a larger or smaller aperture on the camera to make exposure compensation.
- As a basic guide, set a wider aperture on the camera or lens to make the main subject brighter or a smaller aperture to make it darker.

■ Making exposure compensation for the main subject only

In TTL auto flash mode and Auto Aperture flash operation

Making exposure compensation for a flash illuminated main subject without affecting the background exposure by adjusting the SB-800's flash output level is called flash output level compensation (p. 56).

- This compensation can only be performed with cameras compatible with CLS, digital SLRs not compatible with CLS, cameras in Groups I to III, and COOLPIX cameras compatible with i-TTL.

In Manual flash mode

Making exposure compensation for only the flash illuminated subject by intentionally modifying the SB-800's flash output level (M1/1 to M1/128).

- For cameras in all groups.

■ Making exposure compensation for the background only

Set the camera's exposure mode to Shutter-Priority Auto (S) or Manual (M), and set the shutter speed to one slower than its flash sync shutter speed.

- With cameras providing slow-sync, set the camera's flash sync mode to Slow-sync (p. 58) to bring out background details in low-light situations.
- For details, see your camera's instruction manual.



Exposure compensation and flash output level compensation

Flash output level compensation

You can make exposure compensation for the flash illuminated subject without affecting the background exposure by modifying the SB-800's flash output level.

- Available in TTL auto flash mode, Auto Aperture flash and Distance-priority manual flash operations.
- In the TTL auto flash mode or Auto Aperture flash operation, flash output level compensation is only available with cameras compatible with CLS, digital SLRs not compatible with CLS, cameras in Groups I to III, and COOLPIX cameras compatible with i-TTL.
- With F-601/N6006 and F-601M/N6000 cameras, make flash output level compensation on the camera. Flash output level compensation cannot be made on the SB-800. The amount of compensation set on the camera does not appear on the SB-800's LCD panel. For details, see your camera's instruction manual.
- With SLR cameras that have a built-in Speedlight with an exposure compensation function, you can compensate the flash output level on either the camera or the SB-800. For details, see your camera's instruction manual. If you use both controls, the exposure is modified by the sum total of both compensation values. In this case, the SB-800's LCD panel shows only the compensation value set on the SB-800.

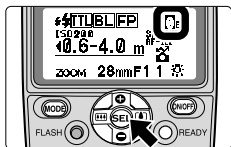

- 1 Press the **SEL** button to highlight the Flash output level compensation value.

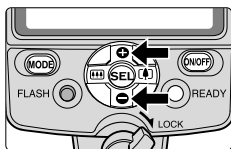

- 2 Press the **+** or **-** button to increase or decrease the compensation in 1/3 steps from -3.0 to +3.0 EV.

- 3 Press the **SEL** button.
 - The highlighted flash output level compensation value returns to normal display. The last highlighted number is the one automatically set.

Canceling flash output level compensation

The flash output level compensation cannot be canceled by turning the SB-800 off. To cancel, press the **+** or **-** button to return the compensation value to "0".

Flash shooting distance range with zoom lenses having a variable aperture

With zoom lenses having a variable aperture, take note of the following before setting the aperture on the SB-800 and confirming the flash shooting distance range.

- For details, read the instruction manuals of your camera and lenses.

📷 Lenses having a variable aperture

There are two maximum aperture values indicated in the lens model name of certain zoom lenses. For example with the AF Zoom-Nikkor 28-105mm f/3.5-4.5D IF, the maximum aperture at 28mm is f/3.5, but decreases to f/4.5 at 105mm.

■ Setting the aperture on the camera's LCD panel or in the viewfinder

Lock the lens aperture at its minimum. After composing the picture by zooming in or out, read the aperture on the camera's LCD panel or in the viewfinder. Then set the same aperture on the SB-800's LCD panel and confirm the flash shooting distance range.

■ Setting the aperture using the scale on the lens

After zooming in or out to select the appropriate composition, read the aperture using the aperture scale on the lens. Then set the same aperture on the SB-800's LCD panel and confirm the flash shooting distance range.

At wideangle zoom settings, read the aperture value at the green index (or line).

At telephoto settings, read the aperture value at the yellow index (or dot).

At intermediate settings, read the aperture value between the two indexes.

■ Setting the aperture on the camera's aperture dial

(F-401x/N5005, F-401s/N4004s, F-401/N4004 cameras + CPU lens)

After zooming in/out to select the desired composition, set the aperture on the camera's aperture dial. Then set the same aperture on the SB-800's LCD panel and confirm the flash shooting distance range.

- Set the camera's exposure mode to Aperture-Priority Auto (**A**) or Manual (**M**).
The aperture cannot be set in the Programmed Auto (**P**) or Shutter-Priority Auto (**S**) exposure mode.
- If the aperture dial is set beyond lens' aperture range, set the lens' minimum (or maximum) aperture on the SB-800's LCD panel.

Slow-sync flash mode, Red-eye reduction control,

■ Slow-sync flash

The flash is controlled at a slow shutter speed to obtain the correct exposure for both the main subject and background in low-light situations or at night.

- Available with cameras providing slow-sync. You cannot set the slow-sync function on the SB-800 directly, but must set it on the camera. For more information, refer to your camera's instruction manual.
- Since slow shutter speeds are normally used, use of a tripod is recommended to prevent camera shake.

■ Red-eye reduction

To prevent the center of your subject's eyes from appearing red in color pictures, the SB-800 fires three flashes at reduced output just before the picture is taken.

- Available with cameras having red-eye reduction control. You cannot set red-eye reduction on the SB-800 directly, but must set it on the camera. For more information, refer to your camera's instruction manual.
- After setting your camera to red-eye reduction, make sure that "👁" appears on the SB-800's LCD panel.

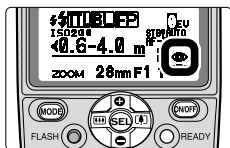

■ Red-eye reduction with slow-sync flash mode

In this mode, red-eye reduction is combined with slow sync.

- Available with cameras having red-eye reduction with slow-sync. You cannot set this mode on the SB-800 directly, but must set it on the camera. For more information, refer to your camera's instruction manual.
- After setting your camera to red-eye reduction with slow sync, make sure that "👁" appears on the SB-800's LCD panel.
- Since slow shutter speeds are normally used, use of a tripod is recommended to prevent camera shake.

and Rear-curtain sync

■ Rear-curtain sync

In normal flash photography, when shooting fast-moving subjects at slow shutter speeds, unnatural-looking pictures can occur, because the subject frozen by the flash appears behind or within the blurred movement (see photo below right).

Rear-curtain flash sync creates a picture in which the blur of a moving subject (for example, the taillights of a car) appears behind the subject and not in front.

- In front-curtain sync, the flash fires immediately after the front curtain opens completely; in rear-curtain sync, the flash fires just before the rear curtain starts to close.
- Available with cameras providing rear-curtain sync. You cannot set this mode on the SB-800 directly, but must set it on the camera. For details, see your camera's instruction manual.
- Since slow shutter speeds are usually used, use a tripod to prevent camera shake.
- This function does not operate in Repeating flash operation.
- In multiple flash, the master flash unit can be set to either front-curtain or rear-curtain sync flash. However, the remote units cannot be set to rear-curtain sync flash (p. 72).



Rear-curtain sync



Front-curtain sync

Shooting data

- Focal length: 70mm
- Shutter speed: 2 sec.
- Aperture: f/4.5
- Flash mode: Manual
- Flash output level: M1/1

Auto FP High-Speed Sync mode (for compatible cameras)

High-Speed flash synchronization at your camera's highest shutter speed is now possible. In this mode, the Auto FP High-Speed Sync mode is automatically set when the shutter speed exceeds the camera's sync shutter speed. This is useful when you want to use a wider aperture to achieve shallow depth of field to blur the background.

- Available with compatible cameras. You cannot set the Auto FP High-Speed sync mode on the SB-800 directly, but must set it on the camera.
- High-speed flash synchronization is possible exceeding your camera's sync shutter speed up to your camera's highest shutter speed.
- Auto FP High-Speed sync also operates in the Advanced Wireless Lighting mode.
- Available flash modes are i-TTL, Auto Aperture flash, Distance-priority manual flash, and Manual flash when using a single flash unit. i-TTL, Auto Aperture flash, Non-TTL auto flash, and Manual flash are available in multiple flash operation.



Flash Value Lock (FV Lock) (for compatible cameras)

Flash Value, or “FV,” is the amount of flash exposure for the subject. Using FV Lock with compatible cameras, you can lock in the appropriate flash exposure for the main subject. This flash exposure remains locked in, even if you change the aperture or composition, or zoom the lens in and out.

- Available with compatible cameras. You cannot set the FV Lock function on the SB-800 directly. Set it on the camera.
- Available flash modes are i-TTL, Auto Aperture flash and Non-TTL auto flash.

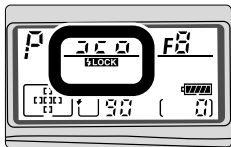

Autofocus flash operation in dim light

When the light is too dim for normal autofocus operation, the SB-800's Wide-Area AF-Assist Illuminator enables you to perform autofocus flash photography.

- In dim light, the Wide-Area AF-Assist Illuminator turns on automatically when the camera's shutter release button is lightly pressed, if an AF lens is mounted and the camera's focus mode is set to S (Single Servo AF with focus priority), AF, or A.
- The effective shooting distance with the Wide-Area AF-Assist Illuminator is approx. 1m to 10m (3.3 to 33 ft.) with a 50mm f/1.8 lens or less, depending on the lens in use.
- Usable lens focal length: 24mm to 105mm (35 to 105mm for F-501/N2020 cameras).
- Use the center focus area in your camera's viewfinder when using the wide-area AF-Assist Illuminator.

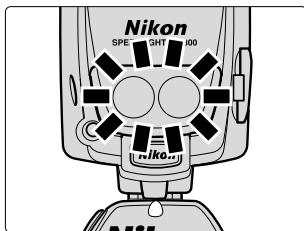

For cameras compatible with CLS

- The SB-800's Wide-Area AF-Assist Illuminator supports the dynamic-area AF system of cameras compatible with CLS.
- With a D2H camera, for example:
Usable lens focal length: 24mm to 105mm.
A total of 11 focus areas are usable at a lens focal length of 35mm or longer as shown in the figure below.
A total of 9 focus areas excluding the extreme right- and left-hand ones are usable at a lens focal length of less than 35mm.

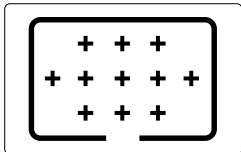

- With AF cameras such as the D2H, the effective shooting range of the wide-area AF-assist Illuminator is approx. 1m to 10m (3.3 to 33 ft.) or less in the mid portion of the frame, and 1m to 7m (3.3 to 23 ft.) or less at the periphery (with a 50mm f/1.8 lens). These ranges may vary depending on the lens in use.
- For details, see your camera's instruction manual.

✔ Notes on using the Wide-Area AF-Assist Illuminator

- If the focus indicator does not appear in the camera's viewfinder even through the Wide-Area AF-Assist Illuminator turns on, focus manually.
- The Wide-Area AF-Assist Illuminator will not light up, if the camera's autofocus is locked or the SB-800's ready-light does not come on.
- Refer to your camera's instruction manual for more information.

✔ Activating and canceling the Wide-Area AF-Assist Illuminator

You can set the SB-800's Wide-Area AF-Assist Illuminator to activate or cancel in the Custom settings mode (p. 67).

- By default, the Wide-Area AF-Assist Illuminator is set to activate.

✔ Canceling the SB-800's flash firing but not the Wide-Area AF-Assist Illuminator

The SB-800's Wide-Area AF-Assist Illuminator comes on but the flash unit will not fire when "FIRE" is set to "OFF" (canceled) in the Custom settings mode (p. 67).

- By default, "FIRE" is set to "ON".

✔ For cameras having a built-in Speedlight

- Even when the camera's AF-Assist Illuminator is set to activate, the SB-800's Wide-Area AF-Assist Illuminator is given priority and the camera's AF-Assist Illuminator does not light up. However, the camera's AF-Assist Illuminator lights up only when the SB-800's Wide-Area AF-Assist Illuminator is canceled.
- With F80-Series/N80-Series, F75-Series/N75-Series and F65-Series/N65-Series cameras, the camera's AF-Assist Illuminator lights up when the SB-800's Wide-Area AF-Assist Illuminator is canceled. To cancel the camera's AF-Assist Illuminator, cancel it on the camera. For details, refer to your camera's instruction manual.
- With F60-Series/N60 cameras, the camera's AF-Assist Illuminator lights up while shooting at full output manual. For details, refer to your camera's instruction manual.

✔ Using the SB-800 off-camera

When using the SB-800 off-camera with the TTL Remote Cord SC-29, autofocus flash photography in dim light is possible, because the SC-29 features an AF-assist illuminator function (p. 111).

Using the Quick Recycling Battery Pack SD-800

Use the provided quick recycling battery pack to install five batteries to shorten the recycling time (p. 19).



WARNING

Notes on using the Quick Recycling Battery Pack SD-800

- With the SD-800 attached, be sure to use five batteries.
- Be sure to replace all five batteries, including the one in this pack and the four inside the SB-800, with fresh ones at the same time.
- Do not mix battery brands or types, or use old with new batteries. Otherwise, the batteries may leak corrosive liquids, become hot, or explode.
- This battery pack cannot be used when the Power Bracket Unit SK-6/SK-6A is attached to the SB-800.

Battery chamber lid

Quick recycling battery pack lock switch

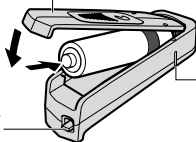

Battery chamber lid attachment index

- The battery chamber lids for the SB-800 and SD-800 are identical.

Attaching the Quick Recycling Battery Pack SD-800

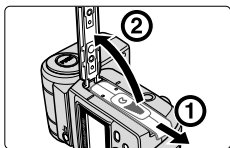

- 1** Slide the SB-800's battery chamber lid in the direction of the arrow to open.

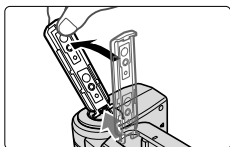

- 2** Push the battery chamber lid back in the direction of the arrow to remove it.
 - The lid can be easily removed if pushed back past the perpendicular position.

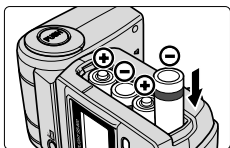

3 Install the batteries in accordance with the ⊕ and ⊖ marks, as shown.

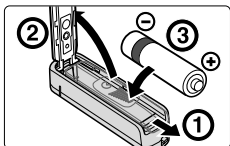

4 Open the SD-800's battery chamber lid to install an extra battery, following the ⊕ and ⊖ marks, as shown.

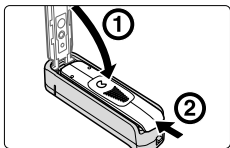

5 Close the battery chamber lid by sliding it into place while pressing down.

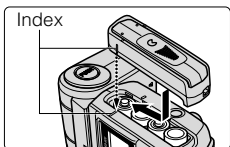

6 Align the index mark on the SD-800's battery chamber lid with the corresponding index mark on the SB-800 and attach the battery pack by sliding it into place.

- Be sure to slide the battery pack until the SD-800's lock switch clicks into place.

■ Detaching the SD-800.

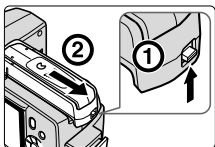

1 Push up the SD-800's lock switch, then slide it to detach.

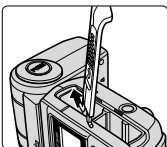

2 Insert one of the hinges of the SB-800's battery chamber lid, as shown.

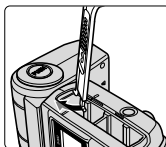

3 Insert the other hinge, as shown.

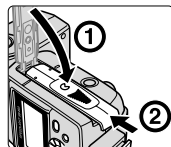

4 Close the battery chamber lid by sliding it into place while pressing down.

Checking the illumination before actually taking the picture (Modeling illuminator)

Press the Modeling illuminator button and the flash fires repeatedly at a reduced flash output level. This is useful for checking the illumination and the shadows cast on the subject before actually taking the picture.

- The flash fires as a Modeling illuminator for a maximum of approx. 3 sec. while the Modeling illuminator button is pressed.
- This function operates only after the ready-light comes on.

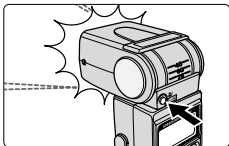

■ Modeling illuminator with cameras attached

When the Modeling illuminator button on the master (SB-800) flash unit or the preview button on a camera compatible with the modeling illuminator is pressed, the modeling illuminator fires.

- For details, see your camera's instruction manual.

■ Modeling illuminator in the Advanced Wireless Lighting (p. 76) (Available with cameras compatible with CLS)

When the Modeling illuminator button on the master flash unit is pressed, the Modeling illuminator of the highlighted master unit or grouped remote flash units fire.

- If the master flash unit and grouped remote flash units are not highlighted, the Modeling illuminator of the master flash unit only fires (except when the master flash unit's flash firing is set to canceled.)

When the preview button on a camera compatible with the modeling illuminator is pressed, the modeling illuminators of the master and all other remote flash units fire.

- Both the master and remote flash units fire at the flash output level compensation value as set.

■ Modeling illuminator in SU-4 type wireless multiple flash operation (p. 84)

When the Modeling illuminator button on the master (SB-800) flash unit or the preview button on a camera compatible with the modeling illuminator is pressed, only the modeling illuminator of the master flash unit fires.

- When the SB-800 is set as a remote flash unit, the Modeling illuminator does not fire even when the Modeling illuminator button is pressed.

■ Do not release the shutter while the modeling illuminator is firing

If you release the shutter while the master flash unit's modeling illuminator is firing, correct exposure cannot be obtained.

Custom functions

The SB-800 can easily set, activate, or cancel various operations using the Custom settings as shown below. Icons appearing on the LCD panel vary depending on the settings and the camera/lens combinations. **No icon appears when the settings are not available.**

For details on setting custom functions, see "Custom settings" (p. 68).

Available Custom functions and the icons



ISO sensitivity (p. 24)



Wireless flash mode (p. 72)



Sound monitor in the wireless flash mode (p. 89)



Non-TTL auto flash mode (p. 38)



Standby function (p. 21)



Selecting the distance unit of measure (m, ft)



Power zoom function (p. 26)



Zoom-head position setting if the built-in wide-flash adapter is broken off accidentally (p. 117)



LCD panel illuminator (p. 119)



LCD panel brightness (p. 119)



Wide-area AF-Assist Illuminator (p. 62)



Canceling flash firing (p. 62)

Custom settings

Setting Custom functions

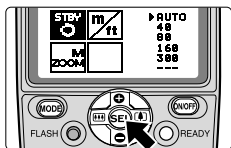

- 1** Press the **[SEC]** button for approx. 2 sec. to display the Custom settings mode.

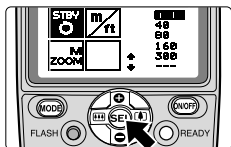

- 2** Press the **[+]** or **[-]** button and **[BRT]** or **[LAMP]** button on the Multi Selector to choose the desired custom functions to be set, then press the **[SEC]** button.

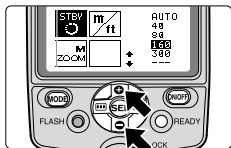

- 3** Press the **[+]** or **[-]** button to highlight the preferred setting.
- Press the **[BRT]** or **[LAMP]** button to adjust the "LCD panel brightness"

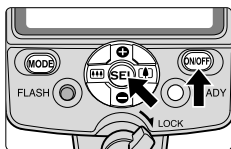

- 4** Press the **[SEC]** button for approx. 2 sec. or press the **[ON/OFF]** button to return to the normal setting mode.

Details on Custom settings (Bold: default setting)



ISO sensitivity (p. 24)

The available ISO sensitivity range is ISO 3 to 8000. Pressing the **+** or **-** button increases or decrease the value in increments of 1/3 step. Pressing the **+** or **-** button continuously increases or decreases the value quickly.

- **100**



Wireless flash mode (p. 72)

Setting the flash mode in wireless multiple flash photography.

- **OFF** : Canceled
- **MASTER** : Master flash unit in the Advanced Wireless Lighting mode
- **MASTER (RPT)** : Master flash unit in the Advanced Wireless Lighting mode (in Repeating flash)
- **REMOTE** : Remote flash unit in the Advanced Wireless Lighting mode
- **SU-4** : SU-4 type wireless flash mode



Sound monitor in the wireless flash mode (p. 89)

When the SB-800 is used as a wireless remote flash unit, you can activate or cancel the sound monitor function.

- **ON** : Sound on
- **OFF** : Sound off



Non-TTL auto flash mode (p. 38)

Setting the Non-TTL auto flash mode.

- **AA** : Auto Aperture flash
- **A** : Non-TTL auto flash



Standby function (p. 21)

Adjusting the time before the standby function is activated.

- **AUTO** : With a camera body that is compatible with TTL auto flash (p. 8), the SB-800 turns off when the camera's exposure meter turns off.
- **40** : 40 sec.
- **80** : 80 sec.
- **160** : 160 sec.
- **300** : 300 sec.
- **---** : Standby function canceled



Selecting the distance unit of measure (m, ft)

Setting the distance unit of measure on the LCD panel to either meters "m" or feet "ft".

- m : meters
- ft : feet



Power zoom function (p. 26)

Setting to activate or cancel the power zoom function, which adjusts the zoom-head position automatically.

- OFF : Activated
- ON : Canceled



Zoom-head position setting if the built-in wide-flash adapter is broken off accidentally (p. 117)

Setting to activate or cancel the zoom-head position setting if the built-in wide-flash adapter is broken off accidentally. When set to ON, the zoom-head position display or AUTO indicator (if using a COOLPIX camera compatible with i-TTL) is framed.

- OFF : Manual setting canceled
- ON : Manual setting activated



LCD panel illuminator (p. 119)

Setting the LCD panel illuminator to turn on or off.

- ON : Turn on
- OFF : Turn off



LCD panel brightness (p. 119)

Adjusting the brightness of the LCD panel. Available brightness levels are graphically displayed in 9 steps on the LCD panel. Press the or button to adjust the brightness.



Wide-Area AF-Assist Illuminator (p. 62)

Setting to activate or cancel the Wide-Area AF-Assist Illuminator.

- ON : Activated (AF-ILL appears on the LCD panel)
- OFF : Canceled (NO AF-ILL appears on the LCD panel)



Canceling flash firing (p. 62)

Setting to activate or cancel flash firing of the SB-800. When it is set to OFF, the SB-800 does not fire but the Wide-Area AF-Assist Illuminator still comes on.

- ON : Firing activated
- OFF : Firing canceled (AF-ILL ONLY appears on the LCD panel)

Advanced operations

Information on advanced flash shooting techniques using the SB-800 is described in this section.

Overview of multiple flash operation

Multiple flash photography allows you to create more natural-looking pictures by using several flash units to emphasize the subject's shape or eliminate shadows.

The following wireless multiple flash operations are available:

Multiple flash operation	Usable cameras	Usable Speedlights
Advanced Wireless Lighting (p. 76)	Cameras compatible with CLS	Only those featuring CLS such as SB-800 for both the master and remote flash units.
SU-4 type wireless multiple flash (p. 84)	No limitation	Master flash unit: Speedlights compatible with wireless flash operation, those compatible with the TTL mode, or the built-in Speedlights on cameras so equipped. Remote flash unit: Except the SB-23, all Speedlights compatible with wireless flash operation or those connected to the optional Wireless Slave Flash Controller SU-4.
Multiple flash operation using cords (p. 90)	No limitation (TTL multiple flash operation is not possible with digital SLRs.)	Speedlights compatible with the TTL mode. <ul style="list-style-type: none">Speedlights SB-11, SB-14, SB-140, and SB-21B cannot be used with the F-401/N4004 or F-401s/N4004s as either master or remote flash units.

- **It's not possible to use different types of multiple flash operations together.**
- Wireless multiple flash operation using Speedlights featuring CLS is called "Advanced Wireless Lighting".

For cameras compatible with CLS and digital SLRs not compatible with CLS, set the master flash unit's flash mode to Auto Aperture **[AA]** flash or Non-TTL auto **[A]** flash in SU-4 type wireless multiple flash operation. In multiple flash operation using cords, multiple flash shooting in M (manual) mode only is possible.

Master flash unit and remote flash unit(s)

In this instruction manual, the flash unit mounted on the camera or the one directly connected to the camera via a TTL Remote Cord, such as the SC-17, SC-28 or SC-29, is called the master flash unit. All other flash units are called the remote flash units.

■ Be sure to cancel Monitor Preflashes (in TTL multiple flash operation)

In SU-4 type wireless multiple flash and multiple flash using cords, cancel the Monitor Preflashes of the master flash unit following one of the methods described below, since Monitor Preflashes cause incorrect exposure.

SB-800	<ul style="list-style-type: none"> Set the SU-4 type wireless multiple flash mode
SB-80DX, SB-50DX	<ul style="list-style-type: none"> Set the wireless flash mode.
SB-800, SB-600, SB-80DX, SB-50DX, SB-28, SB-28DX, SB-27, SB-26, SB-25	<ul style="list-style-type: none"> Set the flash mode to Standard TTL flash. Tilt the flash head up. Use a non-CPU lens.
Built-in Speedlight (F80-Series/N80-Series, F75-Series/ N75-Series, F70-Series/N70)	<ul style="list-style-type: none"> Set the exposure mode to M (Manual).

✓ Notes on performing multiple flash (common to both wireless and wired operation)

- To avoid accidental firing, turn off the camera and all flash units before mounting the master flash unit on or connecting it to the camera.
- When using a Speedlight that has a standby function as a remote flash unit, make sure that the standby function is set to off, or select a standby duration that is long enough, using the Custom settings.
- The SB-800's and SB-80DX's standby function is canceled while the SB-50DX's standby duration is prolonged to approx. one hour when they are set to the wireless remote flash mode.
- Set the angle of coverage of the remote flash units wider than the picture angle, so that the subject will receive sufficient illumination even when the angle of the flash head is off axis from the subject. (In Advanced Wireless Lighting, the zoom-head position is automatically set to 24mm, except when the built-in wide-flash adapter or Nikon Diffusion Dome is attached.) Remember, the closer the subject, the wider the angle of coverage required.
- The brightness of the flash illumination is inversely proportional to the square of the distance between the flash unit and the subject. For example, if the distance between Speedlight A and the subject is 1m (3.3 ft.), and Speedlight B is 2m (6.6 ft.), the combined brightness of the two Speedlights will be:
 $A : B = 1^2 : 2^2 = 1 : 4$ (in meters) or $3.3^2 : 6.6^2 = \text{approx. } 11 : 44$ (in feet)
 Therefore, the illumination provided by Speedlight A is four times (or two steps) brighter than that provided by Speedlight B.
- To ensure good results, it's recommended to make test shots before shooting important events.
- Be sure to read the instruction manuals of your camera and Speedlight(s) before use.

Wireless multiple flash shooting

Read the following when setting up the SB-800 as a remote flash unit in the Advanced Wireless Lighting and SU-4 type wireless multiple flash modes.

Flash set-up in the Advanced Wireless Lighting

Set up the camera, master flash unit, and remote flash units as shown in the figure below.

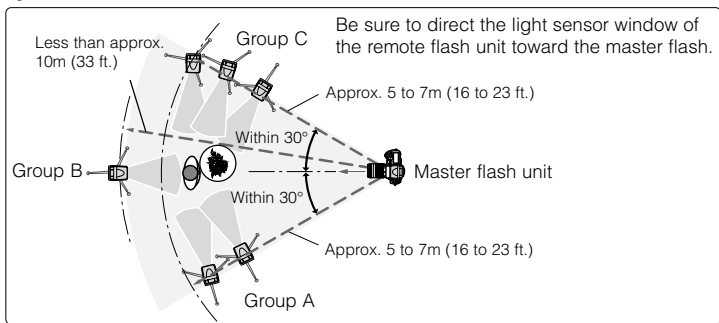

- As a basic guide, the effective shooting distance between the master and remote flash units is approx. 10m (33 ft.) or less in the front position, and approx. 5 to 7m (16 to 23 ft.) at both sides. These ranges vary slightly depending on the ambient light.
- Be sure to place all remote flash units that are set in the same group close together.
- For the effective shooting distance between the master and remote flash units in SU-4 type wireless multiple flash shooting, refer to page 85.

Setting up the master and remote flash units

- In most cases, position the remote flash unit(s) closer to the subject than the camera, so that light from the master flash unit can reach the light sensor of the remote flash unit(s). This is particularly necessary when holding a remote flash unit in your hand.
- Data communication cannot be performed properly if there is an obstacle between the master unit and remote flash units.
- Take care not to let light from the remote flash unit enter the camera lens directly or indirectly in TTL auto flash mode. Also, prevent light from entering the master flash unit's light sensor in Non-TTL auto flash mode. Otherwise, the correct exposure cannot be obtained.
- There is no limit to the number of remote flash units that can be used together. However, if too much light from other remote flash units enters the light sensor of the master flash unit, correct operation may be impossible. Practically, the number of remote flash units in Advanced Wireless Lighting should be limited to three for one group.
- Use the provided Speedlight Stand AS-19 for stable placement of the remote flash units.
- Be sure to perform test firing after setting up all flash units (p. 20).

Using the Speedlight Stand

Use the provided Speedlight Stand AS-19 for stable placement of the remote flash units.

- You can also use the stand for setting up your Nikon Speedlight when using it as a remote flash unit in multiple flash shooting using cords (p. 90).

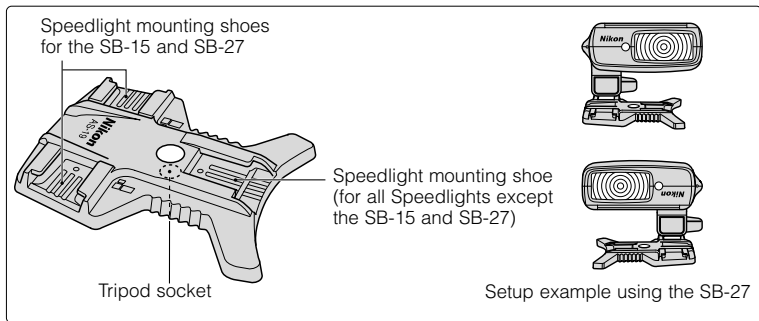

Attachment to the Speedlight Stand

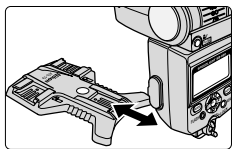

- Attach the SB-800 to the Speedlight Stand in the same way that you attach it to the camera's accessory shoe. The same is true when detaching it from the camera.

To prevent the remote flash units from firing accidentally

Effective for the SU-4 type wireless multiple flash only

- Do not leave the power of the remote flash units on. Otherwise, ambient electric noise due to a discharge of static electricity, etc. may trigger them accidentally.
- If you are holding the remote flash unit in your hand, press the Modeling illuminator button/Wireless remote flash cancel button on the SB-800 to avoid accidental firing in sync with other Speedlights. The SB-800 will not fire, while this button is pressed.

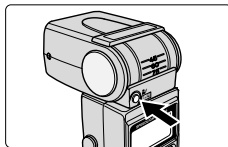

Flash shooting in Advanced Wireless Lighting

When the SB-800 is used with Nikon cameras compatible with CLS, **Advanced Wireless Lighting is possible.**

In this mode, you can divide the remote flash units into a maximum of three groups (A, B, C) and set the flash mode and flash output level compensation values separately for each group as well as the master flash unit, providing automatic control of the light output.

■ Setting the SB-800 to Advanced Wireless Lighting

You can set the SB-800 to Advanced Wireless Lighting using Custom settings (p. 67).

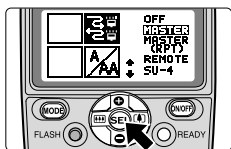

Select **“MASTER”** to set the SB-800 as the master flash unit in the Custom settings mode.

- The indicator \curvearrowright appears on the LCD panel.
- In case of performing Repeating flash operation, select “MASTER (RPT)” instead of “MASTER”.

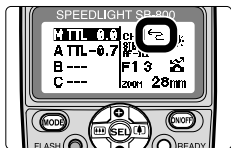

MASTER

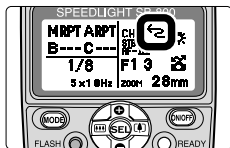

MASTER (RPT)

Select **“REMOTE”** to set the SB-800 as a remote flash unit in the Custom settings mode.

- The indicator \curvearrowleft appears on the LCD panel.
- To set group and channel numbers on the remote flash units, see instructions on page 79.
- To fire the remote flash units via control of the camera's built-in flash in Commander mode (D300, D200, D80 and D70-series), refer to “Built-in flash - Commander mode” in the Custom Settings chapter of the camera's instruction manual.



■ Settings in Advanced Wireless Lighting

In this mode, set the following items on either the master flash unit or the remote flash units.

Item	Speedlight to be set	Remarks
Flash mode	Master flash unit	<p>The following five flash modes are available:</p> <p>TTL : i-TTL mode</p> <p>AA (A) : Auto Aperture flash (Non-TTL auto flash) *1</p> <p>M : Manual flash</p> <p>RPT : Repeating flash</p> <p>-- : Flash canceled</p> <p>Set the flash mode of the remote flash units on the master flash unit.</p> <p>The flash mode can be set independently on the master flash unit and for each group of remote flash units*2.</p>
Flash output level compensation	Master flash unit	Flash output level compensation values of the remote flash units can also be set on the master flash unit. The flash output level compensation values can be set independently on the master flash unit and for each group of remote flash units.
Communication channel*3	Master and remote flash units	Select one of the four available channels. Be sure to set the same channel number for both the master flash unit and remote flash units
Group name	Remote flash units	A maximum of 3 groups (A, B, C)

*1 Auto Aperture flash is automatically set when a CPU lens is mounted on cameras compatible with CLS. However, Non-TTL auto flash is set when a non-CPU lens is mounted or Non-TTL auto flash is selected using Custom settings.

*2 If Repeating flash has been set on the master flash unit, either the Repeating flash mode or Flash canceled mode can be set on the remote flash units from the master unit.

*3 If a photographer uses the same type of wireless remote flash setup near you, your remote flash units may accidentally fire in sync with that photographer's master flash unit. To avoid this, use a different channel number.

📷 Commander function

The "Commander function" in Advanced Wireless Lighting enables the SB-800 to act as a commander unit during wireless multiple flash shooting to trigger remote flash units without firing itself. To activate the "Commander function," set the SB-800 as the master flash unit and set its flash mode to "Flash canceled (---)". This operation will normally not affect the correct exposure of the subject, although the exposure might be affected if the subject is close and a high ISO sensitivity has been set. To limit this effect as much as possible, bounce the light by tilting or rotating the SB-800's flash head.

Flash shooting in Advanced Wireless Lighting

■ Setting the flash mode, flash output level compensation values, and channel number on the master flash unit

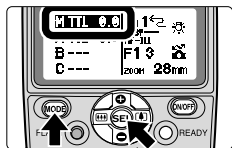

- 1** Press the **SEL** button on the master flash unit to highlight “M”, then press the **MODE** button to choose the desired flash mode.

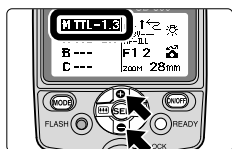

- 2** Press the **+** or **-** button to increase or decrease the flash output level compensation values.
- Compensation values can be set in 1/3 steps from -3.0 to +3.0 EV.
 - The flash output level can be set from M1/1 to M1/128 in the Manual **M** mode.

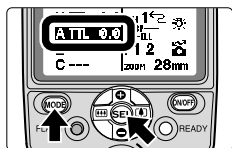

- 3** Press the **SEL** button to highlight “A”, then press the **MODE** button to set the flash mode on the remote flash unit within group A.
- If the master unit’s flash mode has been set to Repeating flash, the Repeating flash or Flash canceled mode can be set on the remote flash unit.

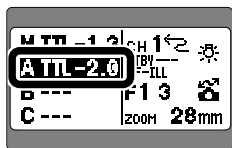

- 4** Following step 2 above, set the flash output level compensation values on the remote flash unit within group A.

- 5** As in steps 3 and 4, set the flash mode and flash output level compensation values on the remote flash units within groups B and C.

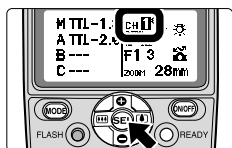

- 6** Press the **SEL** button on the master flash unit to highlight the channel number, then press the **+** or **-** button to set the channel number.

■ Setting a group and channel number on the remote flash units



- 1 Press the **CH** button on the remote flash unit to highlight the channel number, then press the **+** or **-** button to set the channel number.

- Be sure to choose the same channel number as set on the master flash unit.

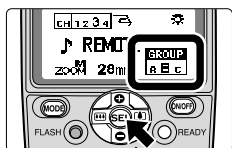

- 2 Press the **GROUP** button on the remote flash unit to highlight the group, then press the **+** or **-** button to set the group.

- For remote flash units where the flash mode and flash output level compensation values are to be set identically, place these flash units into the same group.

✓ Notes on using camera's built-in flash in Commander mode

Camera	Available flash mode of built-in flash	Usable channel number	Usable group
D300, D200, D80	TTL, M, -- (Flash canceled)	1 to 4	A, B
D70-Series	(Flash canceled)	3	A

☑ Setting in the Repeating flash mode

When the master flash unit is set to the **RPT** (repeating flash) mode, set the flash output level, the frequency (Hz) and the number of repeating flashes per frame. (Refer to "Repeating **RPT** flash" on page 48.)

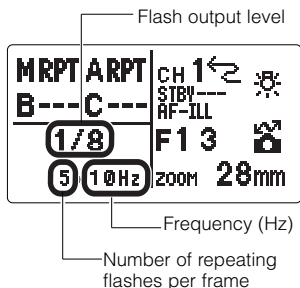

- 1 Press the **CH** button to highlight the flash output level display, then press the **+** or **-** button to increase or decrease the values.

- 2 Press the **GROUP** button.
 - The flash output level is set, then the frequency display is highlighted.

- 3 Repeat the procedures above to set the frequency and the number of repeating flashes per frame.

- If Repeating flash has been set on the master flash unit, either the Repeating flash mode or Flash canceled mode can be set on the remote flash units from the master unit.

Flash shooting in Advanced Wireless Lighting

Examples of flash shooting in Advanced Wireless Lighting



Wireless multiple flash (three flash units)



On-camera single flash

The master flash unit M illuminates the subject while the light from the remote flash unit A is bounced off the ceiling to illuminate the background and create a more natural-looking picture. Remote flash unit B is used with a colored gel filter to create the warmth feeling of a fireplace.

Shooting data

- Camera: D2H
- Focal length: 25mm
- Master flash unit M: SB-800 (**TTL**, +1/3 flash output level compensation)
- Remote flash unit A: SB-800 (**TTL**, +1/3 flash output level compensation)
- Remote flash unit B: SB-800 (**M**, 1/16 flash output level)

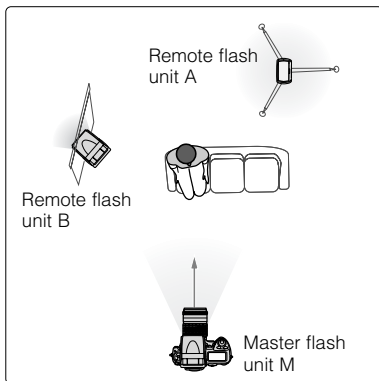

For more details regarding the above example, see the separate booklet, "A collection of example photos."

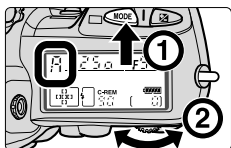

- 1 Set the camera's exposure mode to Aperture-Priority Auto (A).

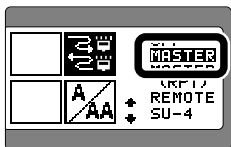

- 2 Set the wireless flash mode of the on-camera SB-800 to MASTER using Custom Settings (p. 67).

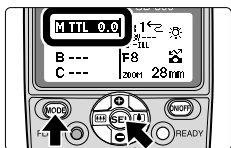

- 3 Press the **SE** button on the master flash unit to highlight "M", then press the **MODE** button to choose **TTL**.



- 4 Press the **+** button on the master flash unit to set the flash output compensation value to +0.3.

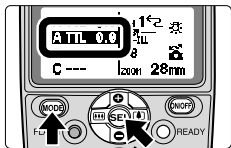

- 5 Press the **SE** button on the master flash unit to highlight "A", then press the **MODE** button to set the flash mode to **TTL** on the remote flash unit A.

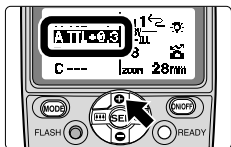

- 6 Likewise, press the **+** button on the master flash unit to set the flash output level compensation value to +0.3 on the remote flash unit A.

Flash shooting in Advanced Wireless Lighting

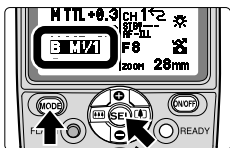

- 7** Press the **SEL** button on the master flash unit to highlight “B”, then press the **MODE** button to set the flash mode to **M** on the remote flash unit B.

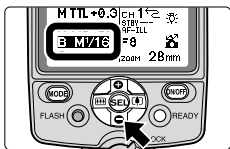

- 8** Likewise, press the **+** button on the master flash unit to set the flash output level to 1/16 on the remote flash unit B.

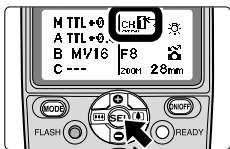

- 9** Press the **SEL** button on the master flash unit to highlight the channel number, then press the **+** or **-** button to set the channel number to 1.

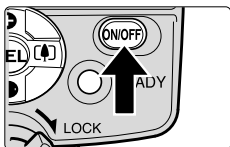

- 10** Set up remote flash units A and B. Turn the power on, then confirm that the ready-lights come on.
- Use a tripod or the Speedlight Stand AS-19 for placement of the remote flash units (p. 75).

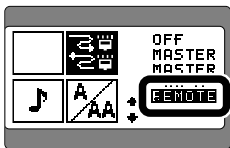

- 11** Set the remote flash units A and B to REMOTE.



- 12** Set the channel number of the remote flash units A and B to 1.
- Be sure to choose the same channel number as set on the master flash unit.

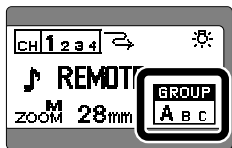

13 Set the group of the remote flash units A and B.

- Set the remote flash unit A to group A and the remote flash unit B to group B.

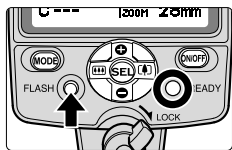

14 Confirm that all the ready-lights of the master and remote flash units are on, then press the **FLASH** button on the master flash unit to test fire the units.

- The master flash unit fires first, then the remote flash units in group A fire, followed by those in group B.
- If a certain remote flash unit does not fire, change the setup by moving the remote unit closer to the subject or redirect its light sensor window toward the master flash unit, then test fire the new setup.
- You can check the illumination before actually taking pictures using the Modeling illuminator (p. 66).

15 Finally confirm the aperture and flash shooting distance just as in TTL flash shooting, then shoot.

- Refer to page 17 for TTL flash shooting.
- Flash operation can be confirmed by the ready-light or the beeping sound (p. 89).

SU-4 type wireless multiple flash shooting



SU-4 type wireless multiple flash can be performed in two ways: (1) In the A (auto) mode, in which the wireless remote flash units start and stop firing in sync with the master Speedlight, and (2) in the M (manual) mode, in which the wireless remote flash units only start firing in sync with the master Speedlight.

- Speedlights featuring wireless multiple flash capability can be used either as the master or remote flash unit.
- Speedlights compatible with TTL auto flash can be used as the master flash unit. The optional Wireless Slave Flash Controller SU-4 is necessary when you want to use these Speedlights as remote flash units.
- The camera's built-in Speedlight can also be used as a master flash unit.
- There is no limitation in usable cameras.

■ Setting the SB-800 to SU-4 type wireless multiple flash





To perform SU-4 type wireless multiple flash, set the wireless flash mode to "SU-4" using Custom settings (p. 67).

Master flash and remote flash units

- First, set the SB-800's wireless multiple flash mode to "SU-4" using the Custom settings, then attach the SB-800 to the camera. The indicator  appears on the LCD panel telling you that the SB-800 is set as a master flash unit. If you detach the SB-800 from the camera, the indicator automatically changes to  signifying that the SB-800 is set as a remote flash unit.

Notes on the master flash unit

- When the SB-800 is set as the master flash unit, Monitor Preflashes are canceled. For other Speedlights, be sure to cancel the master flash unit's Monitor Preflashes.
- The following flash modes are recommended for the master flash unit.

Camera group		Master flash unit's flash mode
Cameras compatible with CLS	Digital SLR cameras	Non-TTL auto flash mode ( or ) • TTL mode is not possible, although icons are displayed when the MODE button is pressed.
	Film-based SLR cameras	TTL mode
Digital SLRs not compatible with CLS		Non-TTL auto flash mode ( or ) • TTL mode is not possible, although icons are displayed when the MODE button is pressed.
Cameras in Groups I to VI		TTL mode

Setting the flash mode on the remote flash units

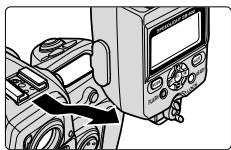

- 1** Detach the SB-800, which is already set to the SU-4 type wireless multiple flash mode, from the camera body.

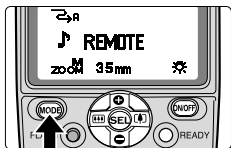

- 2** The flash mode on the remote flash unit toggles between \curvearrowright A (auto) and \curvearrowright M (manual) every time you press the **(MODE)** button.

A (auto) mode

- In the A (auto) mode, the remote flash units start and stop firing in sync with the master flash unit.
- The maximum shooting distance of the SB-800's light sensor is approx. 7m (23 ft.).

M (manual) mode

- In the M (manual) mode, the remote flash units only start firing in sync with the master flash unit.
- The maximum shooting distance of the SB-800's light sensor is approx. 40m (131 ft.).
- The flash output level can be set from M1/1 to M1/128.

SU-4 type wireless multiple flash shooting

■ Wireless multiple flash shooting in the **A** (auto) mode

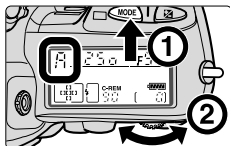

- 1** Set the camera's exposure mode to Aperture-Priority Auto (A) or Manual (M).

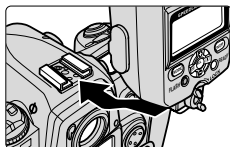

- 2** Set up all Speedlights as the master and remote flash units.

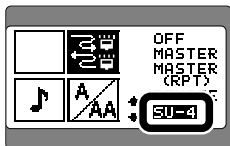

- 3** Set the wireless flash mode of all SB-800's used as master and remote flash units to "SU-4."

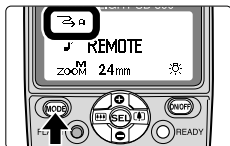

- 4** Press the **MODE** button on the remote flash unit to activate the **A** mode.

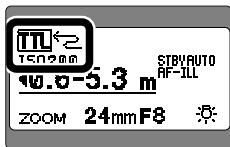

- 5** Set the flash mode of the master flash unit to the **TTL** mode.
- With Nikon digital SLRs not compatible with CLS, set the flash mode to Auto Aperture or Non-TTL auto flash.

- 6** Confirm the aperture and flash shooting distance as in normal TTL auto flash photography, then shoot.
- See page 17 for more information on the TTL auto flash mode.
 - See pages 38 and 40 concerning use of Auto Aperture or Non-TTL auto flash with digital SLRs not compatible with CLS.
 - Flash operation can be confirmed by the ready-light or the beeping sound (p. 89).

Wireless multiple flash shooting in the M (manual) mode

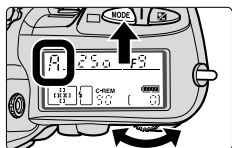

- 1 Set the camera's exposure mode to Aperture-Priority Auto (A) or Manual (M).

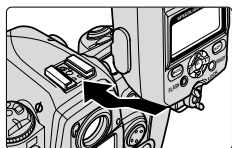

- 2 Set up all Speedlights as the master and remote flash units.

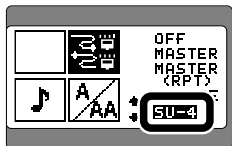

- 3 Set the wireless flash mode of all SB-800's used as the master and remote flash units to "SU-4."

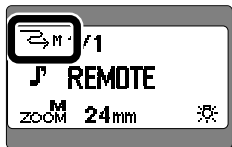

- 4 Press the **MODE** button on the remote flash unit to activate the **M** (manual) mode.

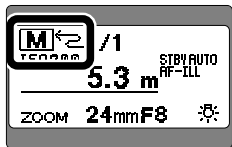

- 5 Set the flash mode of the master flash unit to Manual flash.

- 6 Confirm the aperture and flash shooting distance as in normal Manual flash shooting, then shoot.
 - See page 46 for more information on Manual flash.

SU-4 type wireless multiple flash shooting

▣ Adjusting the flash output level of the remote flash units in the M (manual) mode

Adjusting the flash output level manually

Use the following equation to determine the proper manual flash output level of the remote flash unit, depending on your creative preferences.

$$\text{GN} = \text{F} \times \text{D}$$

where GN is the guide number of the remote flash unit (in meters/feet), F is the lens aperture in use, and D is the distance between the remote flash unit and the subject (in meters/feet).

For example, with the SB-800's zoom-head position adjusted to 28mm when using an ISO sensitivity of 100 if a lens aperture (F) of f/4 is used and the subject distance (D) is 2m (6.6 ft.) away, then shooting a subject at a distance of 2m (6.6 ft.), and a lens aperture of f/4, GN = 8

$$\text{GN (in meters)} = 4 \times 2 = 8$$

$$\text{GN (in feet)} = 4 \times 6.6 = \text{approx. } 26$$

Therefore, to get the correct exposure, refer to the Guide Number table (p. 42) and adjust the flash output level to M1/16.

- Refer to "Determining the aperture and flash output level in the Manual mode" (p. 42).

Adjusting the flash output level in Non-TTL auto flash (A); applicable when using a Speedlight compatible with Non-TTL auto flash mounted on the SU-4 as a remote flash unit

Non-TTL auto flash (A) can also be selected on the remote flash unit. In this case, the remote flash unit controls the flash output based on the aperture and ISO sensitivity set on the remote flash unit, and automatically stops firing in sync with the master flash unit (p. 40).

- 1** Set the same ISO sensitivity on the remote flash unit as set on your camera.
- 2** Set the same aperture on both the lens and the remote flash unit to obtain the correct exposure.
 - Depending on your creative preferences, you can intentionally overexpose or underexpose the picture by modifying the aperture.
 - The above setting is applicable ONLY when both the master and remote flash units are pointed in the same direction.
 - Refer to "Setting apertures in Non-TTL auto flash operation" (p. 41) for more details.

Confirming wireless multiple flash operation using the ready-light or the beeping sound

You can confirm wireless multiple flash operation by checking the ready-light on the SB-800 or the beeping sound during and after shooting.

■ ■ ■ Using the SB-800's beeping sound in the wireless flash mode

When the SB-800 is used as a wireless remote flash unit, you can monitor its operation by listening to the beeping sound (p. 67). This function can be activated or canceled using the Custom settings.

Confirming flash operation using the ready-light or beeping sound

Master flash unit	Remote flash unit		Speedlight condition
	Ready-light	Beeping sound	
Lights up	Lights up	One beep	Ready to fire
Lights up or does not come on (not blinking)	Lights up or does not come on (not blinking)	Two beeps	Fired properly
Blinks for approx. 3 sec.	Blinks for approx. 3 sec.	Beeps for approx. 3 sec.	Both the master and remote flash units have fired at full output and light may have been insufficient for correct exposure. Use a wider aperture and reshoot.
Lights up or does not come on (not blinking)	Blinks for approx. 3 sec.	Beeps for approx. 3 sec.	The remote flash unit has fired at full output and light may have been insufficient for correct exposure. The light sensor could not detect when to stop firing in sync with the master flash unit, because a strong reflection from the remote flash unit itself or light from another remote flash unit may have entered the light sensor window. Change the direction or position of the remote flash unit and reshoot.

Multiple flash shooting using cords

The SB-800 can be used with Speedlights compatible with the TTL auto flash mode to perform multiple flash shooting using cords.

- Use of the SB-50DX and SB-23 as remote flash units is not recommended, because the standby function cannot be canceled.
- Speedlights SB-11, SB-14, SB-140, and SB-21B cannot be used with the F-401/N4004 or F-401s/N4004s as either master or remote flash units.
- There is no limitation in usable cameras.
- With digital SLRs and COOLPIX cameras compatible with i-TTL, only manual flash operation is possible.

■ The maximum number of flash units to be connected using cords

- Up to five units including the master flash unit can be used for multiple flash photography at a total cable length of 10m (33 ft.).
- Make sure the combined total of the coefficients in the table below for all flash units used together does not exceed 20 at 20°C (68°F) or 13 at 40°C (104°F).
- If it exceeds these figures, you may not be able to take a second shot after the first one. In this case, turn off the power of all flash units and reduce the total number of flash units connected.

Speedlight	Coefficient
SB-800, SB-80DX, SB-50DX, SB-30, SB-29, SB-29s, SB-28, SB-28DX, SB-27, SB-26, SB-25, SB-24, SB-22s, SB-14, SB-11, SB-140	1
SB-23, SB-21, SB-17, SB-16, SB-15	4
SB-22	6
SB-20	9

■ Notes on multiple flash shooting using cords

- Be sure to see the instruction manuals of your cameras, Speedlights, and accessories.
- Refer to “System chart for TTL multiple flash shooting using cords” (p. 94) and your cameras and Speedlights instruction manuals for proper connection.
- Use the optional TTL Multi-Flash Sync Cords SC-27, SC-26, SC-19 or SC-18 to connect the SB-800 to more than one remote flash unit.
- Use the optional Multi-Flash Adapter AS-10, if the remote flash units are not equipped with multiple flash terminals.
- Use the optional Multi-Flash Adapter AS-10 to attach the remote flash unit(s) to a tripod.
- Be sure to cancel the master flash unit’s Monitor Preflashes.
- Multiple flash shooting using cords can be performed in two modes: (1) TTL multiple flash; and (2) Manual multiple flash. Performing multiple flash shooting in the Manual mode, however, is not recommended, since it is difficult to obtain the correct exposure. Use the TTL auto flash mode with cameras compatible with TTL auto flash.
- To ensure proper exposure, make test shots before shooting important events.

Multiple flash shooting using cords

■ TTL multiple flash (not possible with digital SLRs and COOLPIX cameras compatible with i-TTL)

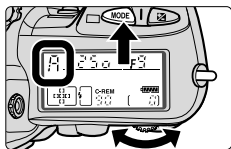

- 1 Set the camera's exposure mode to Aperture-Priority Auto (A) or Manual (M).

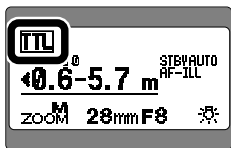

- 2 Attach the master flash unit to the camera, turn the power on, and set the flash mode to TTL auto flash.

- A flash mode, in which Monitor preflashes are fired, cannot be used.

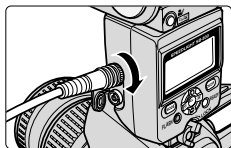

- 3 When using either the optional TTL Multi-Flash Sync Cord SC-27, SC-26, SC-19 or SC-18, turn off all flash units before connecting the master flash unit to the remote flash units.

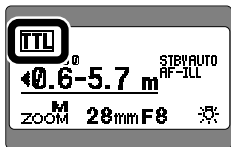

- 4 Turn on all remote flash units and set the flash mode on all remote flash unit to TTL auto flash.

- 5 Confirm the aperture and flash shooting distance as in normal TTL auto flash shooting, then shoot.
 - See page 17 concerning the TTL auto flash mode.
 - When the flash has fired at its maximum output and underexposure may have occurred, the ready-light on the SB-800 blinks for approx. 3 sec. To compensate, use a wider aperture or move closer to the subject and reshoot.

Manual multiple flash

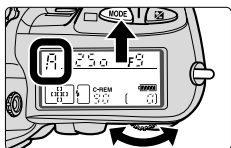

- 1 Set the camera's exposure mode to Aperture-Priority Auto (A) or Manual (M).

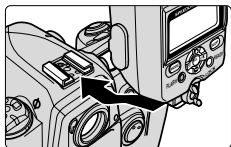

- 2 Turn off the power and attach the master flash unit to the camera.

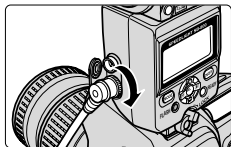

- 3 Connect the sync terminal on the master flash unit to the remote flash unit using the optional Sync Cord SC-11 or SC-15.

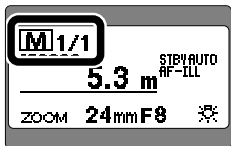

- 4 Turn on the power of all flash units and set the flash mode on all units to Manual flash.
 - The flash output level can be adjusted on the SB-800, SB-80DX, SB-28, and so forth, if necessary (p. 43).
 - Repeating flash is not possible.
- 5 Confirm the aperture and flash shooting distance as in normal Manual flash shooting, then shoot.
 - See page 46 for more information about the Manual flash mode.

System chart for TTL multiple flash shooting using cords

- With the F6, it is not possible to use Auto FP High-Speed Sync and FV Lock operation at the same time.
- Speedlights SB-11, SB-14, SB-140, and SB-21B cannot be used with the F-401/N4004 or F-401s/N4004s as either master or remote flash units.

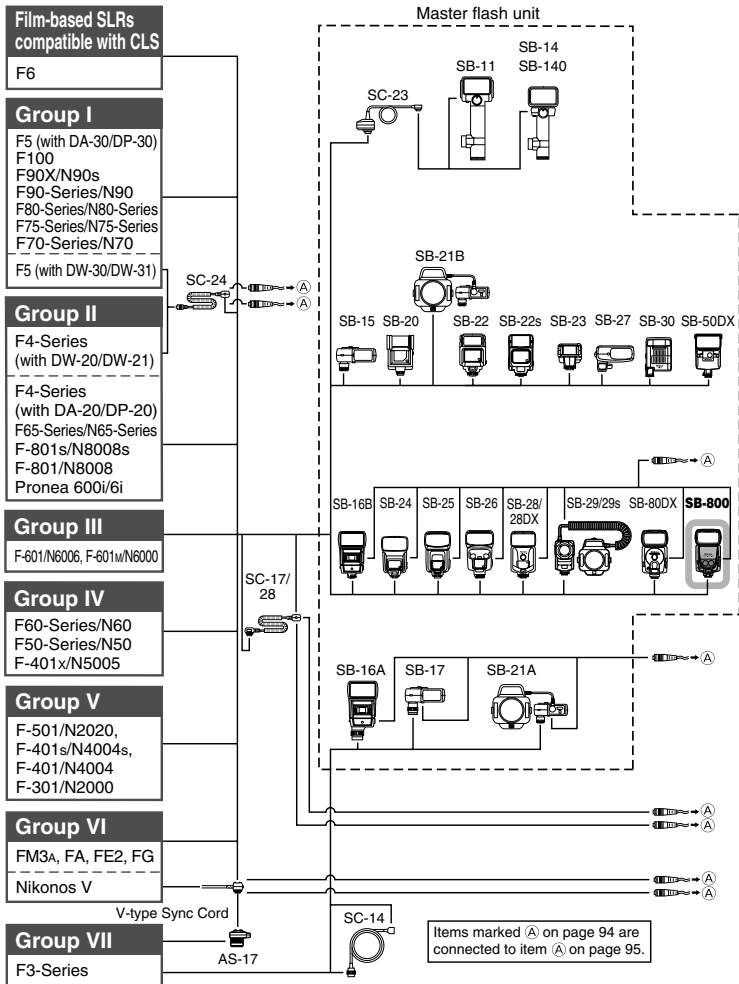

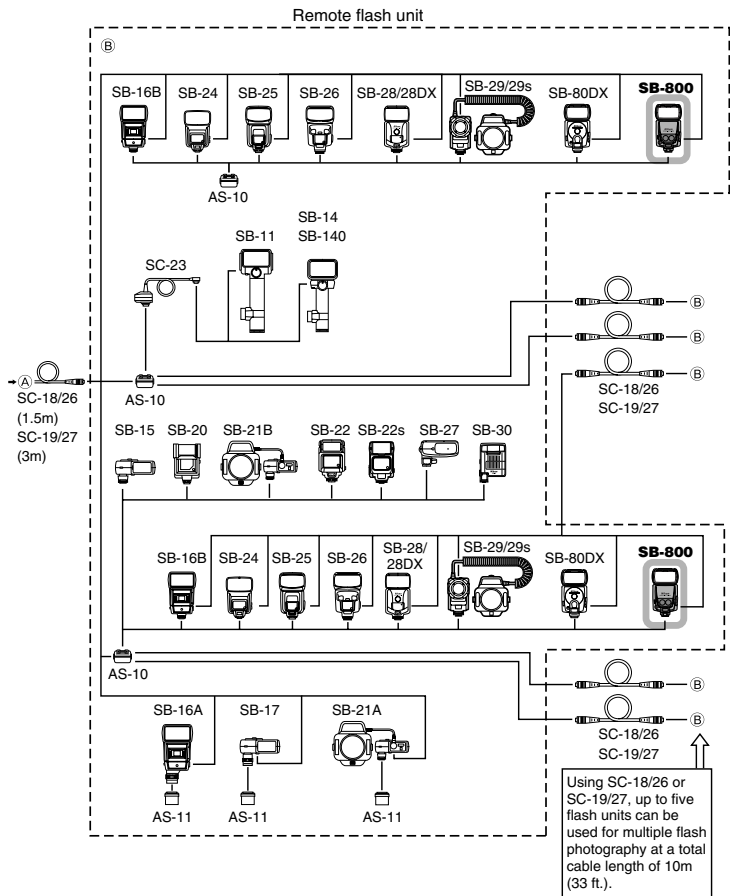

Flash shooting with digital SLRs cameras using

Supplied with the SB-800, the Colored Gel Filter Set SJ-800 includes two filters: the FL-G1 for taking flash pictures under fluorescent light and the TN-A1 for use with incandescent/tungsten light.

- Colored Gel Filter Set SJ-1 is also available as an option (p. 112).

Using colored gel filters with digital cameras

Purpose	Gel filter	Adjust the camera's white balance to:
Balances the color of light from the flash to match that of fluorescent light	FL-G1	Fluorescent
Balances the color of light from the flash to match that of incandescent or tungsten light	TN-A1	Incandescent
Creates interesting effects by changing the light from the flash to a different color	Optional color gel filters	Flash

Balancing light from the flash

With digital cameras, if you shoot flash pictures under fluorescent light with the camera's white balance set to "Flash," the main subject illuminated by the flash will look normal. However, the background will come out green. To compensate, use the FL-G1 (green gel filter) to convert the light coming from the flash to the same color as fluorescent light, then adjust the camera's white balance to "Fluorescent." Follow a similar procedure when shooting flash pictures under incandescent/tungsten illumination using the TN-A1 filter. In this case, set the white balance to "Incandescent."

- Available with digital cameras featuring white balance. You cannot set the white balance on the SB-800. Choose an appropriate white balance setting on your digital camera. For more details, see your camera's instruction manual.
- When using tungsten film with a film-based camera, use the TN-A1 (for incandescent/tungsten light) filter for more effective results.

Notes on using colored gel filters

- These filters are consumable items. When they extremely fade in color or deteriorate, purchase optional Colored Gel Filter Set SJ-1.
- Colored gel filters may become deformed due to the heat generated from the flash head. However, this will not affect their performance. When taking pictures using repeating flash, do not use these filters, because they may become deformed quickly due to the heat.
- There is no difference between the front and back of colored gel filters. Even though they may be curled, this will not affect their performance. Likewise, scratches on these filters will have no effect on performance.
- The amount of exposure compensation printed on each filter is provided as a guide only. Be sure to make test shots to determine the actual amount of compensation required.
- To remove dust or dirt, wipe the filter lightly with a soft, clean cloth.

colored gel filters

How to use colored gels

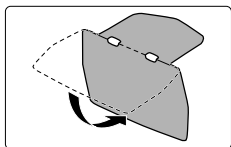

1 Fold the colored gel filter securely on the line.

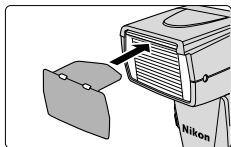

2 Insert the colored gel filter between the wide-flash adapter and the flash head.



3 Adjust the white balance setting on your digital camera, then shoot.

Optional Colored Gel Filter Set SJ-1

The optional Colored Gel Filter Set SJ-1 contains a total of 20 filters in 8 models of colored gels for balancing the color of light or adding specific colors to the scene using a Speedlight (p. 112).

- FL-G1 (for fluorescent light)
- TN-A1 (for incandescent/tungsten light)
- BLUE
- With the last four filters, adjust your digital camera's white balance (if available) to "Flash" for the most effective results.
- FL-G2 (for fluorescent light)
- TN-A2 (for incandescent/tungsten light)
- YELLOW
- RED
- AMBER

Bounce flash operation

With the SB-800 mounted on your camera's hot shoe, you can tilt or rotate the flash head to bounce the light off the ceiling or walls. This is a good technique to use when shooting indoors, because you get more natural-looking pictures of people with softer shadows. Also, you can soften the shadows even more by using the Nikon Diffusion Dome.



Bounce flash



Normal flash

Shooting data:

- Camera: D2H
- Focal length: 60mm
- Speedlight: SB-800 set to **TTL**
- Aperture: f/8
- Shooting distance: Approx. 4m (13.1 ft.)

Shooting data:

- Camera: D2H
- Focal length: 60mm
- Speedlight: SB-800 set to **TTL**
- Aperture: f/9
- Shooting distance: Approx. 4m (13.1 ft.)

For more details on the above example, see the separate booklet, "A collection of example photos".

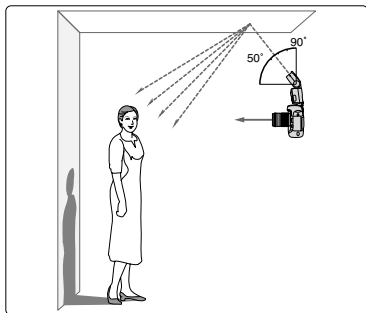

Tilting the flash head

For effective bounce flash off the ceiling, tilt the flash head up at least 50°. Also, make sure that the light from the flash head does not directly illuminate the subject.

- Optimum results are obtained when the flash head is positioned 1–2m (3.3–6.6 ft.) from the reflecting surface.

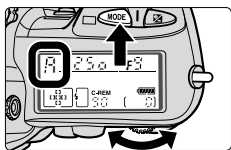

- 1** Set the camera's exposure mode to Aperture-Priority Auto (A) or Manual (M).

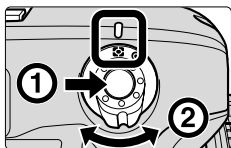

- 2** Set the camera's metering system to Matrix Metering  or Center-Weighted Metering .

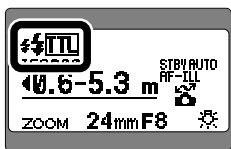

- 3** Set the flash mode to TTL or Auto Aperture or Non-TTL auto flash.

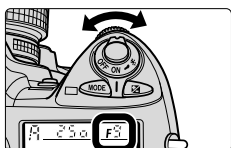

- 4** Set the camera's aperture.
 • Refer to page 100 for setting the aperture.

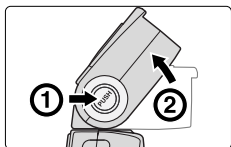

- 5** Adjust the flash head.

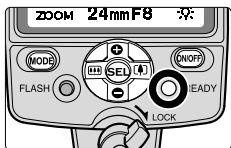

- 6** Make sure that the ready-light is on, then shoot.
 • When the flash has fired at its maximum output and underexposure may have occurred, the ready-light on the SB-800 blinks for approx. 3 sec. To compensate, use a wider aperture or move closer to the subject and reshoot.

Bounce flash operation

■ Setting the aperture

In bounce flash, there is a light loss of 2–3 stops when compared with normal flash photography. Therefore, you should use a wider aperture. When the flash head is adjusted to other than the horizontal/front position, the flash shooting distance range indicator on the SB-800 disappears. To ensure correct exposure, first confirm the flash shooting distance range and aperture with the flash head in the normal position. Next, set this aperture on the camera, then adjust the flash head to the appropriate bounce position.

- In Non-TTL auto flash operation, set the same aperture on the SB-800.

■ Setting the flash head

As shown in the illustrations, tilt or rotate the SB-800's flash head by holding down the flash head tilting/rotating lock release button and adjusting the flash head to match the shooting environment or your creative preferences.

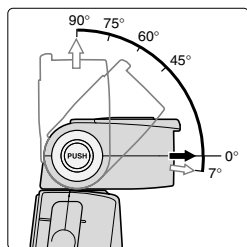

Flash head tilting and rotating angles

The SB-800's flash head tilts up 90° and down -7°, and rotates horizontally 180° to the left and 90° to the right.

- Set the flash head at a click stop at the angles shown.
- When taking close-up pictures with flash, tilt the flash head down to the -7° position (p. 102).

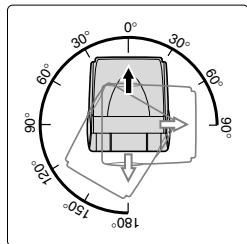

Choosing the reflecting surface

In color photography, select white or highly reflective surfaces to bounce the light off of. Otherwise, your pictures will come out with an unnatural color cast similar to that of the reflecting surface.

Using the built-in bounce card

In bounce flash photography, use the SB-800's built-in bounce card to create a highlight in the subject's eyes, making the eyes look more vibrant.

- As shown in the illustrations, pull out the wide-flash adapter and while holding the bounce card, slide the wide-flash adapter back into place inside the flash head.
- Tilt the flash head up 90° to use this feature most effectively.

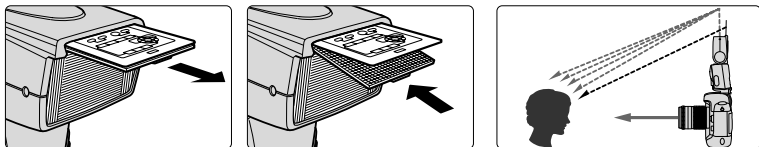

Shooting with the Nikon Diffusion Dome

By attaching the provided Nikon Diffusion Dome over the flash head, you can diffuse the light even more when doing bounce flash, creating extremely soft light with virtually no shadows. With the camera in either the horizontal or vertical position, you get the same effect.

- Good results are generally obtained when the flash head is tilted up 60°.
- Use of the built-in wide-flash adapter in conjunction with the Nikon Diffusion Dome results in the maximum amount of diffused light (p. 104).

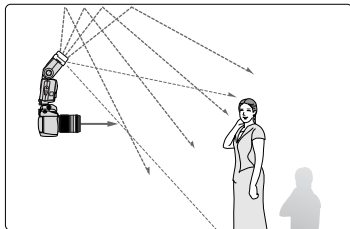

Nikon Diffusion Dome attached

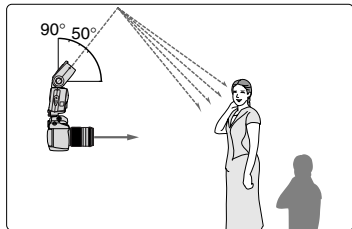

Nikon Diffusion Dome not attached

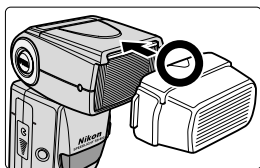

Attach the Nikon Diffusion Dome as shown in the illustration.

- The zoom-head position is automatically set at 14mm.

Close-up flash operation

When the built-in wide-flash adapter is used, close-up flash shooting can be performed. The built-in wide-flash adapter diffuses the light from the flash to soften shadows. When the SB-800 is used off-camera, you can take more natural-looking close-up pictures.

- Be sure to use the wide-flash adapter when taking close-up flash photographs.
- Be careful when using a long lens that the light from the flash is not obstructed by the lens barrel.
- Vignetting may occur in close-up flash photography due to the lighting situation, lens in use, focal length setting, etc. Therefore, make test shots before shooting an important assignment.



Flash shooting with two flash units
(light bounced from the side and top)

Shooting data:

- Camera: D2H
- Focal length: 105mm
- Master flash unit: SB-800 set to **TTL**
- Remote flash unit: SB-800 set to **TTL**
- Aperture: f/22
- Shooting distance: Approx. 1m (3.3 ft.)



Flash shooting with one
camera-mounted flash unit

Shooting data:

- Camera: D2H
- Focal length: 105mm
- Master flash unit: SB-800 set to **TTL**
- Aperture: f/10
- Shooting distance: Approx. 1m (3.3 ft.)

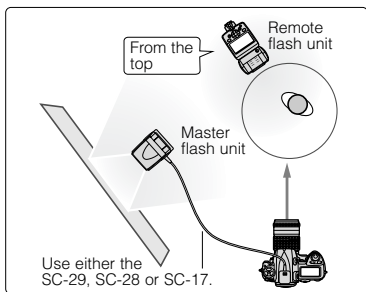

Example of close-up shooting with two flash units

Illumination from the side and top provided by two flash units emphasizes the small subject's contours. Bounced light from the side softens the shadows.

For more details on the above example, see the separate booklet, "A collection of example photos".

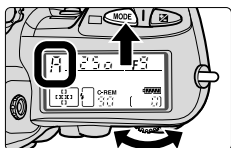

- 1** Set the camera's exposure mode to Aperture-Priority Auto (A) or Manual (M).

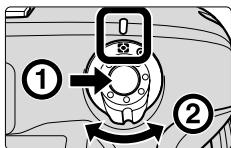

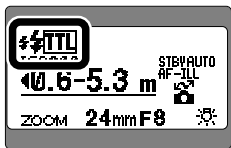

- 2** Set the camera's metering system to Matrix Metering  or Center-Weighted Metering .

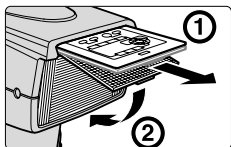

- 3** Set the SB-800's flash mode to TTL auto flash.



- 4** Position the built-in wide-flash adapter over the flash head. Press the  or  button to adjust the zoom-head position to 14mm or 17mm.

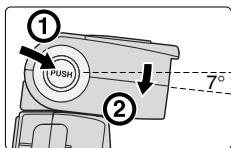

- 5** Tilt the flash head down to -7° .
- When the SB-800 is attached to the camera and used as the only flash unit, this position is recommended to ensure sufficient illumination of the lower portion of the subject in close-up photography.
 - The dotted line below the underbar appears when the flash head is tilted down to this position.

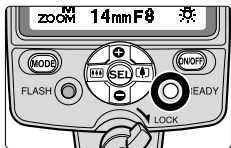

- 6** Confirm that the ready-light is on, then shoot.
- When the flash has fired at its maximum output and underexposure may have occurred, the ready-light on the SB-800 blinks for approx. 3 sec. To compensate, use a wider aperture or move closer to the subject and reshoot.

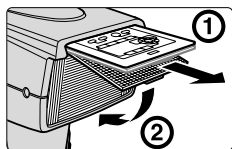

Close-up flash operation

■ Setting the built-in wide-flash adapter and adjusting the zoom-head position

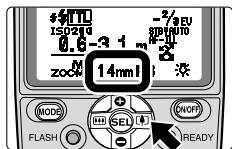

- 1** Slowly pull out the wide-flash adapter all the way, and position it over the flash head. Then slide the bounce card back into place inside the flash head.



- 2** Press the  or  button to adjust the zoom head position to 14mm or 17mm.
- When the wide-flash adapter is set on the flash head, the power zoom function becomes inactive and the zoom-head position is adjusted to 14mm or 17mm. To adjust the zoom-head position, go to the Custom Settings "Zoom-head position setting if the built-in wide-flash adapter is broken off accidentally" (p. 67).
 - To slide the wide-flash adapter back into place, lift it and push it into the flash head as far as it will go.

■ Setting the aperture

Calculate the aperture by using this equation and table. To ensure the correct exposure, use an aperture smaller than the one obtained from the equation.

ISO sensitivity	25	50	100	200	400	800	1000
Coefficient (m/ft)	1.4/4.6	2/6.6	2/6.6	4/13	4/13	5.6/18	5.6/18

$$f/\text{stop} \geq \text{Coefficient} \div \text{Flash-to-subject distance}$$

For example, at an ISO sensitivity of 100 with a subject 0.5m (1.6 ft.) away and the wide-flash adapter in place, the suggested aperture is:

$$f/\text{stop} \geq 2 \div 0.5 = 4 \text{ (in meters)}$$
$$f/\text{stop} \geq 6.6 \div 1.6 = \text{approx. } 4 \text{ (in feet)}$$

Therefore, you should use at least f/4 or an even smaller aperture, such as f/5.6 or f/8.

📷 When shooting subjects closer than 0.6m (2 ft.)

With the SB-800 attached to the camera, sufficient illumination of the subject cannot be obtained. In this case, use the SB-800 off-camera by attaching the optional TTL Remote Cord as shown below.

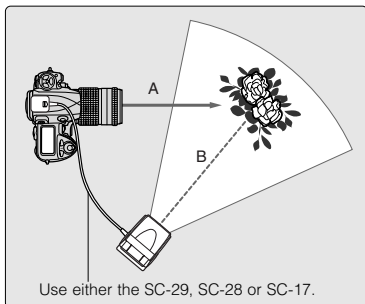

- In **TTL BL** flash operation where Monitor Preflashes are fired, when the SB-800 is used with D/G-type CPU lenses, you may not be able to get the correct exposure, because distance information from the lens is used. In this case, position the camera (A) and the SB-800 (B) at equal distances from the subject.
- For F5 cameras with the High-Magnification Finder DW-30 or DW-31, or F4 cameras with the High-Magnification Finder DW-20 or DW-21, use the optional TTL Remote Cord SC-24 instead of the SC-17.

Flash shooting in the 1/300 TTL High-Speed Flash sync mode (F5 only)



- The farthest flash shooting distance cannot be read on the SB-800's LCD panel. In this case, use the guide number table and equation for calculating this distance, according to each zoom-head position.

$$D \text{ (farthest flash shooting distance)} \\ = \text{Guide number} \div f/\text{stop (aperture)}$$

Guide number (m/ft.) in the 1/300 TTL High-Speed Flash sync mode

ISO sensitivity	Zoom-head position (mm)										
	*1	*2	14 ⁻³	17 ⁻³	24	28	35	50	70	85	105
25	2.5/8	3/10	3.5/11	3.5/11	5.5/18	6/20	7/23	8/26	9/30	9.5/31	10/33
50	3.6/12	4.3/14	5/16	5/16	7.8/26	8.5/28	9.9/32	11.4/37	12.8/42	13.5/44	14.2/47
100	5/16	6/20	7/23	7/23	11/36	12/39	14/46	16/52	18/59	19/62	20/66
200	7/23	8.4/28	9.8/32	9.8/32	15.4/51	16.8/55	19.6/64	22.4/73	25.2/83	26.6/87	28/92
400	10/33	12/39	14/46	14/46	22/72	24/79	28/92	32/105	36/118	38/125	40/131
800	14/46	16.8/55	19.6/64	19.6/64	30.8/101	33.6/110	39.2/129	44.8/147	50.4/165	53.2/174	56/184

- *1 With the Nikon Diffusion Dome attached and the wide-flash adapter in place
- *2 With the Nikon Diffusion Dome attached
- *3 With the wide-flash adapter in place

- For example, when shooting with an ISO sensitivity of 100, at a 35mm zoom-head position and an aperture of f/5.6:

$$D = 14 \div 5.6 (f/\text{stop}) = 2.5 \text{ (in meters)} \\ \text{(farthest flash shooting distance)}$$

$$D = 46 \div 5.6 (f/\text{stop}) = 8.2 \text{ (in feet)} \\ \text{(farthest flash shooting distance)}$$









Reference information

Optional accessories, Troubleshooting, Speedlight care, Specifications, etc. are presented here.









































































TTL auto flash modes available with the SB-800

The available types of TTL auto flash vary, depending on the camera/lens/exposure mode/metering system in use. The following tables show the SB-800's TTL mode indicators and the corresponding ones used in the instruction manuals of Speedlights featuring no CLS when the flash unit is used with various cameras not compatible with CLS.

- Refer to your camera's instruction manual for specific information on camera settings and functions.

Exposure mode P : Programmed Auto S : Shutter-Priority Auto A : Aperture-Priority Auto M : Manual	Metering system  : Matrix  : Center-Weighted  : Spot
TTL/D-TTL auto flash mode  : Automatic Balanced Fill-Flash with TTL Multi Sensor  : Matrix Balanced Fill-Flash, Center-Weighted Fill-Flash/Spot Fill-Flash  : Standard TTL Flash	D TTL  : Automatic Balanced Fill-Flash with TTL Multi Sensor for Digital SLRs D TTL  : Center-Weighted Fill-Flash for Digital SLRs D TTL : Standard TTL Flash for Digital SLRs

Cameras compatible with the TTL/D-TTL auto flash mode

Camera Group	Camera	TTL mode	TTL mode with no CLS	Exposure mode	Metering system	Lens
Digital SLRs not compatible with CLS	D1-Series		 *1	P/S/A/M	 	CPU lens (D/G-type)
			 *2	P/S/A/M	 	CPU lens (except for D/G-type)
				A/M		Non-CPU lens
				P/S/A/M	  	CPU lens
	D100		 *1	P/S/A/M	 	CPU lens (D/G-type)
			 *2	P/S/A/M	 	CPU lens (except for D/G-type)
				P/S/A/M	  	CPU lens
				M	 	Non-CPU lens
*1: 3D Multi-Sensor Balanced Fill-Flash for Digital SLRs is set. *2: Multi-Sensor Balanced Fill-Flash for Digital SLRs is set.						
I	F5 F100		 *2	P/S/A/M	 	CPU lens (D/G-type)
			 *3	P/S/A/M	 	CPU lens (except for D/G-type)
				A/M		Non-CPU lens
				P/S/A/M	  	CPU lens
	F90X/N90s F90-Series/ N90 F70-Series/ N70		 *2	P/S/A/M	  	CPU lens (D/G-type)* 1
			 *3	P/S/A/M	  	CPU lens (except for D/G-type)
				A/M	 	Non-CPU lens
				P/S/A/M	  	CPU lens* 1
			A/M	 	Non-CPU lens	
	*1: The A and M exposure modes cannot be used with a G-type lens. *2: 3D Multi-Sensor Balanced Fill-Flash is set. *3: Multi-Sensor Balanced Fill-Flash is set.					

Camera Group	Camera	TTL mode	TTL mode with no CLS	Exposure mode	Metering system	Lens
I	F80-Series/ N80-Series		*2	P/S/A/M		CPU lens (D/G-type)
			*3	P/S/A/M		CPU lens (Non-D/G-type AF)
				P/S/A/M		CPU lens
				M		Non-CPU lens*1
	F75-Series/ N75-Series		*2	P/S/A		CPU lens (D/G-type)
			*3	P/S/A		CPU lens (Non-D/G-type AF)
				P/S/A/M		CPU lens
				M		Non-CPU lens*1
*1: The camera's exposure meter cannot be used. Set the aperture using the lens aperture ring. *2: 3D Multi-Sensor Balanced Fill-Flash is set. *3: Multi-Sensor Balanced Fill-Flash is set.						
II	F4-Series			P/S/A/M		CPU lens*1
				A/M		Non-CPU lens*2
			*3	P/S/A/M		CPU lens*1
			*3	A/M		Non-CPU lens
				P/S/A/M		CPU lens*1
				A/M		Non-CPU lens
*1: The A and M exposure modes cannot be used with a G-type lens. *2: AI-S, AI, Series E lens only usable. *3: Center-Weighted Fill-Flash is set.						
II	F65-Series/ N65-Series			P/S/A		CPU lens
				P/S/A/M		CPU lens*1
				M		Non-CPU lens*2
*1: Center-Weighted Metering is automatically set when the exposure mode is set to M. *2: The camera's exposure meter cannot be used. Set the aperture using the lens aperture ring.						
II	F-801s/ N8008s			P/S/A/M		CPU lens*1
			*3	P/S/A/M		CPU lens*1/+2
	F-801/ N8008		*3	A/M		Non-CPU lens*2
				P/S/A/M		CPU lens*1/+2
		A/M		Non-CPU lens*2		
*1: The A and M exposure modes cannot be used with a G-type lens. *2: Spot Metering is not possible with the F-801/N8008. *3: Center-Weighted Fill-Flash/Spot Fill-Flash is set.						
II	Pronea 600i/6i			P/S/A/M		CPU lens
				P/S/A/M		CPU lens
				M		Non-CPU lens*1
*1: The camera's exposure meter cannot be used. Set the aperture using the lens aperture ring.						

TTL auto flash modes available with the SB-800

Camera Group	Camera	TTL mode	TTL mode with no CLS	Exposure mode	Metering system	Lens	
III	F-601/ N6006			P/S/A/M		CPU lens (except for G-type)* ¹	
				P/S/A/M		CPU lens (except for G-type)* ¹	
				A/M		Non-CPU lens* ¹	
				P/S/A/M		CPU lens (except for G-type)* ²	
				A/M		Non-CPU lens* ²	
III	F-601M/ N6000			P/S		CPU lens* ¹	
				P/S		CPU lens* ¹	
				A/M		Non-CPU lens* ¹	
				P/S		CPU lens	
				A/M		Non-CPU lens	
*1: Only appears on the SB-800's LCD panel. Matrix Balanced Fill-Flash or Center-Weighted Fill-Flash/Spot Fill-Flash is selected when appears on the camera's LCD panel. *2: Center-Weighted Metering is automatically set when the exposure mode is set to M.							
IV	F60-Series/N60			P/S/A		CPU lens	
	F50-Series/N50			M		CPU/non-CPU lens	
	F-401x/N5005						
V	F-501/N2020			P		CPU* ⁴ /non-CPU lens* ⁵	
	F-301/N2000			A/M		CPU* ⁴ /non-CPU lens	
	*1: Matrix Balanced Fill-Flash is set. *2: Center-Weighted Fill-Flash/Spot Fill-Flash is set. *3: Programmed TTL Auto Flash is set. *4: G-type Nikkor lenses cannot be used. Nikkor lenses for F3AF usable. *5: AI-S, AI, Series E lenses only usable.						
	F-401s/N4004s			P/S		CPU lens	
	F-401/N4004			A/M		CPU lens* ¹	
				M		Non-CPU lens	
*1: Center-Weighted Metering is automatically set when the exposure mode is set to M. *2: Programmed TTL Auto Flash is set.							
VI	FM3A			A/M		CPU (except G-type)/non-CPU lens	
	FA			P/A/M		CPU (except G-type)/non-CPU lens* ¹	
	FE2			A/M		CPU (except G-type)/non-CPU lens* ¹	
	FG			P/A/M		CPU (except G-type)/non-CPU lens* ¹	
	Nikonos V			A/M		CPU (except G-type)/non-CPU lens* ^{1&2}	
	F3-Series			A/M		CPU (except G-type)/non-CPU lens* ³	
*1: Standard TTL Flash is not possible if the shutter speed is set to M250 or B (bulb) for the FA, FE2, and M90 for the FG and Nikonos V cameras. *2: An optional sync cord for land use is required. *3: Optional TTL Unit Coupler AS-17 is required.							

■ Accessories for multiple flash

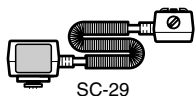

TTL Remote Cord SC-29/28/17 (approx. 1.5m or 4.9 ft)

TTL Remote Cord SC-24 (approx. 1.5m or 4.9 ft)

TTL Remote Cords SC-29/SC-28/SC-17/SC-24 provide TTL auto flash operation when the SB-800 is used off-camera. Their flash shoes come with one tripod socket and two TTL multiple flash terminals. The TTL Remote Cord SC-24 is for use with F5 cameras mounted with a High-Magnification Finder DW-30 or DW-31, or F4 cameras having a High-Magnification Finder DW-20 or DW-21. The SC-29 features an AF-assist illuminator function (The SC-29 is not equipped with a TTL multiple flash terminal.)

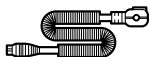

TTL Multi-Flash Sync Cord SC-26/18 (approx. 1.5 m or 4.9 ft)

TTL Multi-Flash Sync Cord SC-27/19 (approx. 3 m or 9.8 ft)

Multi-Flash Sync Cords SC-18/SC-19/SC-26/SC-27 are useful for connecting the SB-800 to the multiple flash terminal of the SC-28, SC-17 or AS-10 for TTL multiple flash operation.



TTL Multi-Flash Adapter AS-10

Use the Multi-Flash Adapter AS-10 when connecting more than three flash units together for TTL multiple flash operation, or if the remote flash units are not equipped with multiple flash terminals. The AS-10 comes with one tripod socket and three TTL multiple flash terminals.

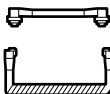

Sync Cord SC-11 (approx. 25 cm or 9.8 in.)

Sync Cord SC-15 (approx. 1 m or 3.3 ft)

Sync Cords SC-11 and SC-15 are handy when you want to use the SB-800 off-camera or for use with cameras not having accessory shoes. These cords also allow you to perform multiple flash operation in the Manual mode.



Sync Terminal Adapter AS-15

The Sync Terminal Adapter AS-15 is necessary when connecting the SB-800 to cameras not having a sync terminal.



Wireless Slave Flash Controller SU-4

Useful for multiple flash photography, the SU-4 features a built-in, movable light sensor and an accessory shoe for attachment of a remote flash unit. The SU-4's light sensor not only triggers the remote unit to fire in sync with the master unit, but controls the flash duration of the remote unit to provide wireless TTL, Non-TTL, or Manual operation.

Optional accessories



TTL Flash Unit Coupler AS-17 for F3-Series cameras
Dedicated adapter for F3-Series cameras providing TTL flash operation with Nikon Speedlights such as the SB-800 featuring an ISO-type mounting foot (not designed for the F3).



Bracket SK-7

A metal plate with attachment screws allowing the camera and Speedlight to be positioned side by side. Use the optional TTL Multi-Flash Adapter AS-10 to attach the SB-800 to Bracket SK-7.

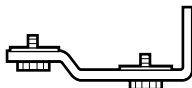

Multi-Flash Bracket Unit SK-E900

(One AS-E900 Multi-Flash Adapter is included with the SK-E900)

Multi-Flash Adapter AS-E900

The SB-800 can be used as a multiple flash unit with Nikon COOLPIX 900-series digital cameras by attaching the COOLPIX to Multi-Flash Bracket Unit SK-E900 and connecting the SB-800 to the multi-flash terminal of the COOLPIX using the Multi-Flash Adapter AS-E900 (p. 34).



Other accessories



Speedlight Stand AS-19

Same as that provided with this SB-800.

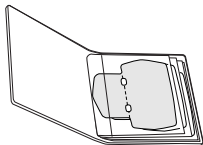

Colored Gel Filter Set SJ-1

A total of 20 filters in 8 models are provided. Colored gel filters are consumable items and subject to a gradual deterioration in color due to the heat generated when the flash fires. Therefore, it is recommended to check and replace these filters when necessary.

Using external power sources

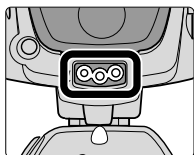

Connecting to an external power source

To use an external power source, remove the cover and connect its power cord to the SB-800's external power source terminal.

- Do not use the power cord SC-16 when connecting the SB-800 to the Nikon DC Unit SD-7; use the SC-16A instead.
- Using external power sources made by another manufacturer is not recommended.

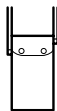

Nikon DC Unit SD-7

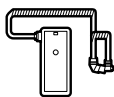

Nikon High-Performance
Battery Pack SD-8A

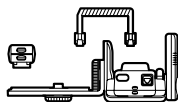

Power Bracket Unit
SK-6/SK-6A

Specifications

External power source	Battery type required	Min. recycling time (approx.)	Min. number of flashes/recycling time (approx.)
DC Unit SD-7 ^{*1}	C-type alkaline-manganese (x 6)	2.5 sec.	350 times/2.5-30 sec.
High-Performance Battery Pack SD-8A ^{*2}	AA-type alkaline-manganese (x 6)	2.5 sec.	320 times/2.5-30 sec.
	AA-type NiCd (1000mAh) (x 6)	2 sec.	190 times/2-30 sec.
	AA-type Nickel (x 6)	2.5 sec.	380 times/2.5-30 sec.
	AA-type Ni-MH (2000mA) (x 6)	2 sec.	300 times/2-30 sec.
	AA-type lithium (x 6) ^{*3}	3.5 sec.	310 times/3.5-30 sec.
Power Bracket Unit SK-6/SK-6A ^{*1}	AA-type alkaline-manganese (x 4)	3 sec.	230 times/3-30 sec.
	AA-type NiCd (1000mAh) (x 4)	2.5 sec.	150 times/2.5-30 sec.
	AA-type Nickel (x 4)	3 sec.	280 times/3-30 sec.
	AA-type Ni-MH (2000mA) (x 4)	2.5 sec.	230 times/2.5-30 sec.
	AA-type lithium (x 4) ^{*3}	3.5 sec.	260 times/3.5-30 sec.

*1 With AA-type alkaline-manganese batteries in the SB-800.

*2 With the same type of batteries in both the external power source and the SB-800.

*3 When fired at an interval of 120 seconds.

- The above data may vary due to variations in performance or whether fresh or old batteries are used.
- In rare cases, when firing the modeling illuminator with the SD-8A or SK-6/SK-6A attached, the SB-800 may be powered by its own batteries, and the external power source does not operate. This is not a malfunction.

Tips on Speedlight care



WARNING

Never use thinner, benzene, or other active agents for cleaning the Speedlight, as this may damage the Speedlight or cause it to catch on fire. Using these agents may also impair your health.

■ Cleaning

- Use a blower brush to remove dirt and dust from the SB-800 and clean it with a soft, clean cloth. After using the SB-800 near saltwater, wipe the flash unit with a soft, clean cloth moistened slightly with plain water to remove the salt, then dry it using a dry cloth.
- On rare occasions, the LCD may turn on or turn dark, due to static electricity. This is not a malfunction. The display will soon return to normal.
- Do not drop the SB-800 or hit it against a hard surface, as this may damage its precision mechanisms. Do not apply strong pressure to the LCD panel.

■ Storage

- Store the SB-800 in a cool, dry place to prevent malfunctions due to high humidity, as well as the growth of mold or mildew.
- Keep the SB-800 away from chemicals such as camphor or naphthalene. Avoid exposing the SB-800 to magnetic waves from TVs or radios.
- Do not use or leave the SB-800 in locations subject to high temperatures such as those encountered near a heater or stove, as this may cause damage.
- When not using the SB-800 for more than two weeks, be sure to remove the batteries to prevent malfunctions due to battery leakage.
- Take the SB-800 out once a month, insert the batteries, and fire the unit several times to reform the capacitor.
- When the SB-800 is stored together with a desiccant, change the desiccant occasionally since it does not absorb moisture effectively after a while.

■ Operating location

- An extreme temperature change can cause condensation inside the SB-800. When taking the SB-800 to a very hot place from a very cold place or vice versa, place it inside an airtight container such as plastic bag. Leave it inside for a while, then expose the SB-800 gradually to the outside temperature.
- Avoid exposing the SB-800 to strong magnetism or radio waves from TVs or high-voltage power transmission towers, as this may cause it to malfunction.

Notes on batteries

■ Usable batteries

Use four (or five) AA-type batteries (1.5V or lower) of any of the following types.

- High-power manganese batteries are not recommended.
- Using the Quick Recycling Battery Pack SD-800 (p. 64) or an external power source (p. 113) increases the number of flashes and provides faster recycling times.

Alkaline-manganese (1.5V)/Nickel (1.5V) batteries

Non-rechargeable. Never attempt to charge these batteries in a battery charger. Otherwise, they may explode.

Lithium (1.5V) batteries

Non-rechargeable. Never attempt to charge these batteries in a battery charger. Otherwise, they may explode.

- Depending on battery specifications, when these batteries become hot, the safety circuits are activated, cutting off power. This often occurs when the flash unit is operated in the repeating flash mode. Battery power will recover when the temperature returns to normal.

NiCd battery (rechargeable, 1.2V) /Ni-MH (rechargeable, 1.2V)

Rechargeable. Before recharging the batteries, be sure to read the instruction manuals for your batteries and battery charger for detailed information on how to handle and recharge the batteries.



**Recycling
rechargeable
NiCd batteries**

To protect the earth's environment, do not dispose of used rechargeable batteries yourself. Instead, take these batteries to your nearest recycling center.

■ Notes on handling batteries

- Because flash consumes a large amount of battery power, rechargeable batteries may not operate properly before reaching the end of their stated lifespan or the number of charging/discharging as specified by the battery manufacturer.
- When replacing batteries, replace all four (or five) batteries at the same time. Do not mix battery types or brands or use old with new batteries.
- When installing batteries, turn off the power of the Speedlight and never reverse the polarity of the batteries.
- If the battery terminals become soiled, remove dirt and smudges before use, as this may cause a malfunction.
- Battery power tends to weaken as the temperature drops. It also gradually decreases when batteries are not used for a long time and recovers after a short break following intensive use. Be sure to check battery power and replace the batteries with fresh ones, if you notice any delays in the recycling time.
- Do not store batteries in locations subject to high temperatures and high humidity.

Troubleshooting

If a warning indication appears on the SB-800's LCD panel or inside the camera's viewfinder, use the following chart to determine the cause of the problem before you take your Speedlight to a Nikon service center for repair.

■ Problems with the SB-800

Problem	Cause	Ref. page
The power cannot be turned on.	The batteries are not correctly installed.	p. 18
The ready-light does not light up.	<ul style="list-style-type: none">• Battery power is weak.• The standby function is activated and operating.	p. 19 p. 21
The power turns off automatically.	The batteries are extremely exhausted.	p. 19
A strange sound can be heard caused by the flash head zooming back and forth even when the SB-800 is turned off.	The batteries are extremely exhausted.	p. 19
The flash shooting distance range does not appear.	The flash head is adjusted to other than the horizontal/front or down -7° position.	p. 23
No TTL , or BL indicator appears in TTL auto flash mode.	The camera's exposure mode or metering system is not correctly set or a non-CPU lens is mounted.	p. 108
The zoom-head position cannot be adjusted to other than 14mm or 17mm.	The built-in wide-flash adapter is in use or the Nikon Diffusion Dome is attached.	p. 101 p. 96
The SB-800 does not work when control buttons (MODE button, + / - button, or ⏏ / ⏏ button) and SEL button are pressed.	Control buttons are locked.	p. 12
The SB-800 does not fire.	Canceling flash firing is activated in the Custom settings mode.	p. 67

■ ■ ■ If the built-in wide-flash adapter is broken off accidentally

If the wide-flash adapter is subjected to a strong impact while set on the flash head, it may be broken off. In this case, visit your nearest authorized Nikon service center for repair.

- When the wide-flash adapter is broken off, it is no longer possible to set the zoom-head position to other than 14mm or 17mm. To adjust the zoom-head position, go to the Custom Settings “Zoom-head position setting if the built-in wide-flash adapter is broken off accidentally” (p. 67).

■ ■ ■ Warning indications in the SB-800

Problem	Cause	Ref. page
The ready-light blinks for 3 sec. after firing. The underexposure indicator blinks and the amount of underexposure is displayed, depending on the camera in use.	Underexposure may have occurred.	p. 33
The dotted line below the underbar appears.	The flash head is tilted down -7° .	p. 23
The aperture indicator displays “ FEE ” and the shutter cannot be released.	The aperture on the lens is not set at its minimum.	—
Three beeps sound during wireless multiple flash shooting.	The flash has fired at its maximum output and under exposure may have occurred.	p. 89

Ready-light warning inside the camera's viewfinder

Problem	Cause	Ref. page
Cameras in Groups I (except for F70-Series/N70) to VI and Digital SLRs cameras		
The ready-light blinks when pressing the shutter release button slightly in the TTL auto flash mode.	The SB-800 is not correctly attached to the camera.	p. 22
Cameras in Groups V and VI		
The ready-light blinks when the power is turned on in TTL auto flash mode.	<ul style="list-style-type: none"> The ISO sensitivity set on the camera is higher than the available range of the Speedlight. The ISO sensitivity set on the camera is higher or lower than the available range for the FA camera. 	—
Cameras in Group VI		
The ready-light blinks in the TTL auto flash mode.	The shutter speed is set to M90, M250, or B (bulb).	p. 110
FM3A, New FM2 cameras		
The ready-light blinks.	The shutter speed set is faster than the flash sync speed.	—
New FM2, F55-Series/N55-Series cameras.		
The ready-light blinks when the flash mode is set to TTL auto flash.	The SB-800's flash mode is set to TTL auto flash.	p. 110

Note

The SB-800 incorporates a microcomputer to control flash operations. In rare cases, the SB-800 may not work properly even after fresh batteries are properly installed. If this happens, replace the batteries while the SB-800's power is turned on.

Warning

- Batteries should not be exposed to excessive heat such as strong sunshine, a fire, or the like.
- Dry batteries should never be recharged in a battery charger.
- Do not expose the SB-800 to water as this may result in an electric shock or cause the unit to catch on fire.

About the LCD panel

■ Characteristics of the LCD panel

- Due to the directional characteristics of LCDs, the LCD display is difficult to read when viewed from above. However, the display can be seen clearly from a somewhat lower angle.
- The LCD display becomes darker at high temperatures (approx. 60°C/140°F), but returns to normal at normal temperatures (20°C/68°F).
- The LCD's response time slows down at low temperatures (approx. 5°C/41°F and below), but returns to normal at normal temperatures (20°C/68°F).

■ Using the SB-800 in dim light

Press any button on the SB-800 to turn the illuminator on (when the SB-800 power is on), and it will remain lit for approx. 16 seconds.

- To cancel the LCD panel illumination, go to the Custom settings mode (p. 67) and set it off.
- Even if the LCD panel illuminator is set to OFF, the SB-800's LCD panel illuminator turns on when the camera's LCD panel illuminator is turned on. The LCD panel illuminator also lights up when the Custom settings mode is displayed.

■ Adjusting the LCD panel brightness

The brightness of the LCD panel can be adjusted in the Custom settings mode for easier reading (p. 67).

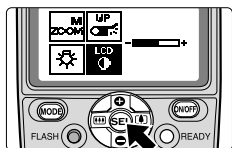

- 1 Select "LCD" in the Custom settings mode, then press the **SEL** button.

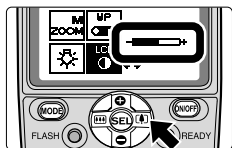







- 2 Press the **MEM** or **DISP** button to highlight the desired brightness level.
 - Available brightness levels are graphically displayed in 9 steps on the LCD panel.

Specifications

Electronic construction	Automatic Insulated Gate Bipolar Transistor (IGBT) and series circuitry	
Guide number (at 35mm zoom-head position, 20°C/68°F)	38/125 (ISO 100, m/ft), 53/174 (ISO 200, m/ft)	
Flash shooting distance range (TTL auto flash/ Auto Aperture flash/ Non-TTL auto flash)	0.6m to 20m (2 to 66 ft.) (varies depending on the ISO sensitivity, zoom-head position, and lens aperture in use)	
Flash exposure control		
Indicator	Available flash mode	Usable camera
TTL	i-TTL mode	Cameras compatible with CLS, COOLPIX cameras compatible with i-TTL
TTL	D-TTL mode	Digital SLRs not compatible with CLS
TTL	TTL (film based) mode	Cameras in Groups I to VI (film based cameras)
BL (appears with TTL)	Balanced Fill-Flash	Cameras compatible with CLS, digital SLRs not compatible with CLS, cameras in Groups I to IV (No BL appears with cameras in Groups III to IV)
AA	Auto Aperture flash	Cameras compatible with CLS, digital SLRs not compatible with CLS, cameras in Groups I to II and COOLPIX cameras compatible with i-TTL
A	Non-TTL auto flash	No limitation
GN	Distance-priority manual flash	Except D1x and D1H digital cameras
M	Manual flash	No limitation
RPT	Repeating flash	Except COOLPIX cameras compatible with i-TTL
Other available functions Test firing, Monitor Preflashes, AF-assist illuminator, and Modeling illuminator		
Nikon Creative Lighting System	A variety of flash operations are available with compatible cameras: i-TTL mode, Advanced Wireless Lighting, FV Lock flash, Flash color information communication, Auto FP High-Speed sync, and Wide-area AF-Assist Illuminator	
Multiple flash operation	Available multiple flash	Usable camera
	Advanced Wireless Lighting	Cameras compatible with CLS
	SU-4 type wireless multiple flash	No limitation
	Multiple flash shooting using cords	No limitation
Flash exposure control set on the camera	Slow-sync, Red-eye reduction, Red-eye reduction in slow-sync, Rear-curtain sync flash, Auto FP High-Speed sync, FV Lock flash	

Angle of coverage	Variable in 7 steps, plus three steps with wide-flash adapter and Nikon Diffusion Dome			
	Zoom-head position	Angle of coverage	Vertical	Horizontal
	14mm *1	14mm	110°	120°
	14mm *2	14mm	110°	120°
	17mm *2	17mm	100°	110°
	24mm	24mm	60°	78°
	28mm	28mm	53°	70°
	35mm	35mm	45°	60°
	50mm	50mm	34°	46°
	70mm	70mm	26°	36°
	85mm	85mm	23°	31°
	105mm	20°	27°	
	*1 With the Nikon Diffusion Dome attached			
	*2 With the built-in wide-flash adapter set			
Bounce capability	Flash head tilts down to -7° or up to 90° with click-stops at -7°, 0°, 45°, 60°, 75°, 90°; flash head rotates horizontally 180° to the left or 90° to the right with click-stops at 0°, 30°, 60°, 90°, 120°, 150°, 180°			
ON/OFF button	<ul style="list-style-type: none"> Press the ON/OFF button for approx. 0.3 sec. to turn the SB-800 on or off. Standby function can be set. 			
Power source/ min. recycling time/no. of flashes (at M1/1 output)	Four (or five) AA-type penlight batteries (1.5V or lower) of any of these types: Alkaline-manganese (1.5V), Lithium (1.5V), Nickel (1.5V), NiCd (rechargeable, 1.2V), or Ni-MH (rechargeable, 1.2V)			
	Batteries	Number of batteries	Min. recycling time (approx.)*	Min. number of flashes/recycling time*
	Alkaline-manganese	x4	6.0 sec.	130/6-30 sec.
		x5	5.0 sec.	130/5-30 sec.
	Lithium	x4	7.5 sec.	170/7.5-30 sec.
		x5	7.5 sec.	190/7.5-30 sec.
	Nickel	x4	6.0 sec.	140/6-30 sec.
		x5	5.0 sec.	140/5-30 sec.
	NiCd (1000 mAh) (rechargeable)	x4	4.0 sec.	90/4-30 sec.
		x5	3.5 sec.	90/3.5-30 sec.
	Ni-MH (2000 mA) (rechargeable)	x4	4.0 sec.	150/4-30 sec.
x5		2.9 sec.	150/2.9-30 sec.	
	* With fresh batteries.			
	• M1/1 output without use of AF-assist illuminator, zoom operation, and LCD panel illuminator.			

Specifications

External power sources (optional)	External power source	Battery type
	DC Unit SD-7	Six C-type alkaline-manganese
	High-Performance Battery Pack SD-8A	Six AA-type alkaline-manganese
	Power Bracket Unit SK-6/SK-6A	Four AA-type alkaline-manganese
Ready-light	<ul style="list-style-type: none"> • Lights up when the SB-800 is recycled and ready to fire. • Blinks for 3 sec. when flash fires at its maximum output, indicating light may have been insufficient (in TTL Auto Flash, Auto Aperture  Flash and Non-TTL Auto Flash  operations) 	
Flash duration (approx.)	1/1050 sec. at M1/1 (full) output 1/1100 sec. at M1/2 output 1/2700 sec. at M1/4 output 1/5900 sec. at M1/8 output 1/10900 sec. at M1/16 output 1/17800 sec. at M1/32 output 1/32300 sec. at M1/64 output 1/41600 sec. at M1/128 output	
Mounting foot lock lever	Provides secure attachment of SB-800 to camera's accessory shoe using locking plate and mount pin to prevent accidental detachment.	
Flash output level compensation	-3.0 to +3.0 EV in increments of 1/3 steps in the TTL auto flash, Auto Aperture flash modes and Distance-priority manual flash	
Custom settings	By pressing the  and  ,  or  buttons, the following custom settings are possible: ISO sensitivity, Wireless flash auto, Sound monitor in the wireless flash mode, Non-TTL auto flash, Standby function, Selecting the distance unit (m, ft.), Canceling power zoom function, Zoom-head position setting if the built-in wide-flash adapter is broken off accidentally, LCD panel illuminator, Brightness of the LCD panel, AF-assist illuminator, and canceling flash firing.	
Other functions	Recalling the underexposure value in the TTL auto flash mode, Resetting the settings, Button lock	
Built-in wide-flash adapter	Allows SB-800 to be used with 14mm or 17mm lens	
Dimensions (W x H x D)	Approx. 70.5 x 129.5 x 93.0mm (2.8 x 5.1 x 3.7 in.)	

Weight (without batteries)	Approx. 350g (12.3 oz.)
Accessories supplied	Quick Recycling Battery Pack SD-800, Speedlight Stand AS-19, Colored Gel Filter Set SJ-800, Nikon Diffusion Dome SW-10H, External power source terminal cap, Soft Case SS-800

These performance specifications are applicable when fresh batteries are used at normal temperatures (20 °C/68 °F).

Specifications and design are subject to change without notice.

- Refer to the Speedlight parts and their functions (p. 10) and Icons on the LCD panel (p. 13) for each part name and display indications.

Symbol

+/- button	12
i-TTL mode	36

A

AF-ILL	62
AF-ILL ONLY	62
Accessories	111
Advanced Wireless Lighting	76
Aperture-priority auto exposure (A)	29
Auto Aperture flash	38
Auto FP High-Speed sync	60
Automatic Balanced Fill-Flash	37

B

Batteries	18, 115
Beyond the flash shooting distance range warning	45
Bounce flash operation	98
Built-in wide-flash adapter	104
Button lock	12

C

CLS	5
COOLPIX	34
CPU Nikkor lenses	16
Camera groups	8
Canceling flash firing	67
Channel	78
Close-up flash operation	102
Colored gel filters	96
Communication channel	77
Compatible with CLS	8
Continuous flash shooting	51
Control button quick reference	12
Control buttons	12
Custom functions	67

D

D-TTL mode	36
D-type Nikkor lenses	16
Default settings	6
Digital SLRs not compatible with CLS	8
Distance-priority manual flash	44
Dotted line below the underbar	23

E

Exposure compensation	54
Exposure mode	28
External power source	113

F

FLASH button	12
FV Lock flash	61
Flash Color Information Communication	5
Flash head	100
Flash head tilting/rotating lock release button	22
Flash modes	35
Flash output level	42, 48
Flash output level compensation value	56
Flash shooting distance range	31
Flash sync mode	32
Frequency	48
Front-curtain sync	32

G

G-type Nikkor lenses	16
Group	8
Guide number	42

H

Highlighted items	15
-------------------------	----

I

ISO sensitivity.....	24
ISO sensitivity factors.....	43
Icons.....	13

L

LCD panel illuminator.....	119
LCD panel.....	119

M

MASTER.....	15, 72
MODE button.....	30
Manual exposure (M) mode.....	29
Manual flash.....	46
Manual mode.....	42
Master flash unit.....	72
Metering system.....	28
Minimum recycling time.....	19
Modeling illuminator.....	66
Monitor Preflashes.....	36
Mounting foot lock lever.....	22
Multi Selector.....	12
Multiple flash operation.....	72
Multiple flash shooting using cords.....	90

N

NO AF-ILL.....	62
Nikon Creative Lighting System.....	5
Nikon Diffusion Dome.....	101
Non-CPU lenses.....	16
Non-TTL auto flash.....	40
Non-TTL auto flash mode.....	38
Number of flashes.....	19, 48

O

ON/OFF button.....	12
--------------------	----

P

Power zoom function.....	26
Programmed auto (P).....	28

Q

Quick Recycling Battery Pack.....	64
-----------------------------------	----

R

REMOTE.....	72
Ready-light.....	20, 33
Rear-curtain sync.....	59
Red-eye reduction control.....	58
Red-eye reduction with slow-sync flash.....	58
Remote flash unit.....	72
Repeating flash.....	48
Reset.....	12

S

SU-4 type wireless multiple flash shooting.....	84
Selecting the distance unit (m or ft.).....	70
Shutter-priority auto exposure (S).....	29
Slow-sync flash mode.....	58
Soft Case.....	6
Sound monitor.....	89
Speedlight Stand.....	75
Speedlight parts and their functions.....	10
Standard TTL flash.....	37
Standby function.....	21
Supplied accessories.....	6

T

TTL mode.....	37
Test firing.....	20

U

Underexposure value in the TTL auto flash mode.....	33
Using the built-in bounce card.....	101

W

Wide-Area AF-Assist Illuminator.....	5, 62
Wireless flash mode.....	69
Wireless master flash unit.....	72
Wireless multiple flash shooting.....	72
Wireless remote flash.....	72

Z

Zoom-head position.....	26
-------------------------	----

Nikon

No reproduction in any form of this manual, in whole or in part (except for brief quotation in critical articles or reviews), may be made without written authorization from NIKON CORPORATION.

NIKON CORPORATION

Fuji Bldg., 2-3 Marunouchi 3-chome,
Chiyoda-ku, Tokyo 100-8331, Japan

Printed in Europe

TT8F03 (11)
8MSA0711-03