

Nikon

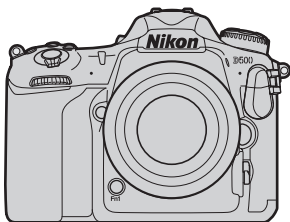

D500 Professional Setting Guide — Movie Edition —

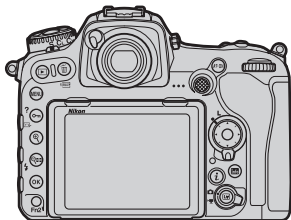

En

Table of Contents

Movie-Related Camera Controls	4
Recording Movies	6
Before Recording	8
• Frame Size/Frame Rate.....	8
• ISO Sensitivity Settings	10
• Set Picture Control CHECK IT OUT ✓	11
• White Balance.....	12
• Active D-Lighting CHECK IT OUT ✓	13
• Microphone Sensitivity	13
• Frequency Response.....	13
• Wind Noise Reduction.....	14
More on Movies	15
• The Information Display.....	15
• Custom Control Assignments CHECK IT OUT ✓	17
• Electronic Vibration Reduction CHECK IT OUT ✓	20
• The Movie i -Button Menu	21
• White Balance.....	22
• Choosing a Picture Control in Live View	23
• Taking Photos CHECK IT OUT ✓	24
• Creating Stills from 4K UHD Movies.....	25
• HDMI Output	26
Time-Lapse Movies	29
• Time-Lapse Movie Techniques	29
• Table: Time-Lapse Movie Techniques Compared.....	30
• Filming 4K UHD Time-Lapse Movies.....	31

Things to Note	33
• Restrictions on Available Settings	33
• Keeping the Camera Cool	33
• Image Artifacts	34
• Ending Recording	34
Movie Playback Tips and Tricks	35
• Ten-Second Advance/Rewind	35
• Skipping to an Index or the Last/First Frame	35
• Slow Motion	35
• Using the Touch Screen	36
Joining Movie Files Together <i>CHECK IT OUT</i> ✓	37
D500 Movie Specifications	39

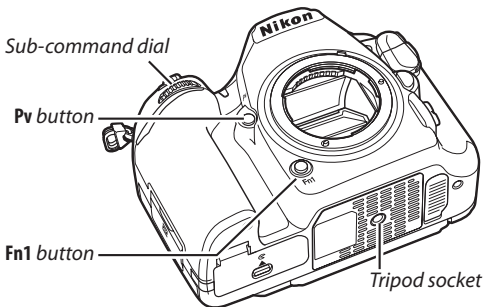
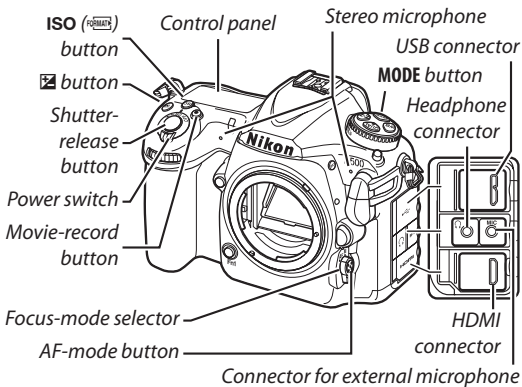

Movie-Related Camera Controls

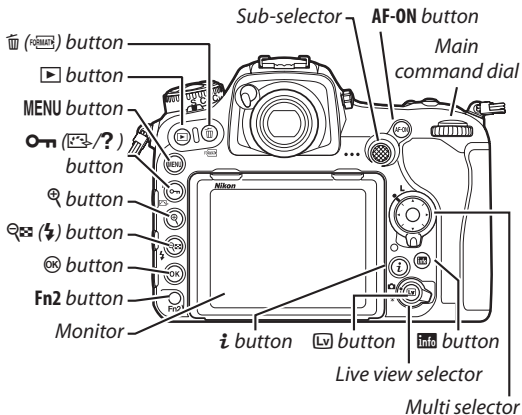



The monitor features touch-screen controls. In movie mode (in live view or during recording), you can touch the monitor to focus on the selected point. Touch-screen controls can also be used for movie playback ([page 36](#)).

Recording Movies

- 1 Start movie live view.**
Rotate the live view selector to  and press the  button.

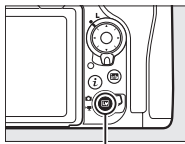

Lv button

- 2 Focus.**
Frame the opening shot and press the **AF-ON** button or press the shutter-release button half-way to focus.

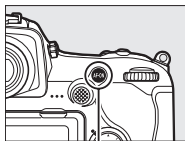

AF-ON button

- 3 Start recording.**
Press the movie-record button to start recording (audio is also recorded; be careful not to cover the built-in microphone). A recording indicator and the time available are displayed in the monitor. The camera can be refocused by pressing the **AF-ON** button, and exposure can be locked by pressing the center of the sub-selector ([page 19](#)) or altered by up to ± 3 EV using exposure compensation.

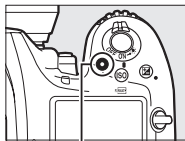

Movie-record button

4 End recording.

Press the movie-record button again to end recording and then press **[Lv]** to exit live view.

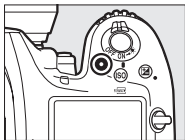

Before Recording

Before recording, adjust settings in the movie shooting menu.



● Frame Size/Frame Rate

Choose an option according to how you will use the movie.

Option	Maximum length
$\frac{2160}{60} \frac{PA}{60}$ 3840 × 2160 (4K UHD); 30p	29 min. 59 s (recorded across up to 8 files of up to 4 GB each; the number and length of the files varies with Frame size/frame rate and Movie quality ; files can be joined together using ViewNX-i as described on page 37).
$\frac{2160}{25} \frac{PA}{25}$ 3840 × 2160 (4K UHD); 25p	
$\frac{2160}{24} \frac{PA}{24}$ 3840 × 2160 (4K UHD); 24p	
$\frac{1080}{60} \frac{PA}{60} / \frac{1080}{60} \frac{P}{60}$ 1920 × 1080; 60p	
$\frac{1080}{50} \frac{PA}{50} / \frac{1080}{50} \frac{P}{50}$ 1920 × 1080; 50p	
$\frac{1080}{30} \frac{PA}{30} / \frac{1080}{30} \frac{P}{30}$ 1920 × 1080; 30p	
$\frac{1080}{25} \frac{PA}{25} / \frac{1080}{25} \frac{P}{25}$ 1920 × 1080; 25p	
$\frac{1080}{24} \frac{PA}{24} / \frac{1080}{24} \frac{P}{24}$ 1920 × 1080; 24p	
$\frac{720}{60} \frac{PA}{60} / \frac{720}{60} \frac{P}{60}$ 1280 × 720; 60p	
$\frac{720}{50} \frac{PA}{50} / \frac{720}{50} \frac{P}{50}$ 1280 × 720; 50p	

File Names

During recording, a new file is created when the current file reaches 4 GB. Normally displayed in white, the file name in the information display flashes amber 30 s and turns red 10 s before a new file is created.



The Movie Crop

The movie crop varies with frame size and, at frame sizes of 1920 × 1080 and 1280 × 720, the option selected for **Choose image area** in the movie shooting menu.

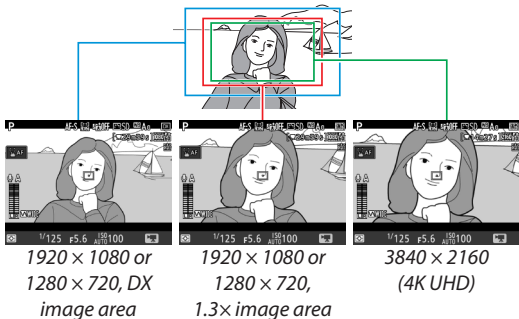

● ISO Sensitivity Settings

ISO sensitivity can be adjusted in movie mode (in live view or during recording).

- **ISO sensitivity (mode M):** Choose the ISO sensitivity for exposure mode **M** from values between ISO 100 and Hi 5. Auto ISO sensitivity control is used in other exposure modes.
- **Auto ISO control (mode M):** Select **On** for auto ISO sensitivity control in exposure mode **M**, **Off** to use the value selected for **ISO sensitivity (mode M)**.
- **Maximum sensitivity:** Choose the upper limit for auto ISO sensitivity control from values between ISO 200 and Hi 5. Auto ISO sensitivity control is used in exposure modes **P**, **S**, and **A** and when **On** is selected for **Auto ISO control (mode M)** in exposure mode **M**.

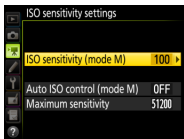

Auto ISO Sensitivity Control

At high ISO sensitivities, the camera may have difficulty focusing and noise (randomly-spaced bright pixels, fog, or lines) may increase. This can be prevented by choosing a lower value for **ISO sensitivity settings** > **Maximum sensitivity**.

● Set Picture Control

Choose a Picture Control for movies.

- **Same as photo settings:** Use the Picture Control settings currently selected in the photo shooting menu.
- **SD Standard:** Standard processing for balanced results. Recommended for most situations.
- **NL Neutral:** Minimal processing for natural results. Choose for footage that you intend to process in post-production.
- **VI Vivid:** Footage is enhanced for a vivid, photoprint effect with emphasis on primary colors.
- **MC Monochrome:** Film monochrome footage.
- **PT Portrait:** Footage of portrait subjects is processed to give skin a natural texture and rounded feel.
- **LS Landscape:** Film vibrant landscapes and cityscapes.
- **FL Flat** **CHECK IT OUT** ✓: Details are preserved over a wide tone range, from highlights to shadows, maximizing the potential for tweaking in post-production. Use with highlight-weighted metering to minimize loss of detail in highlights.

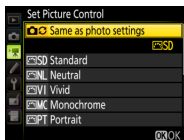

● White Balance

Adjust white balance according to lighting conditions. Choose **Same as photo settings** to use the white balance settings currently selected in the photo shooting menu.

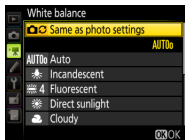

Measuring Preset Manual White Balance

Instead of using a specially-prepared reference object, you can measure white balance from any white or grey object in the frame.

When **Preset manual** is selected for white balance, you can hold the **WB** button in live view to enter direct measurement mode. **PRE** will flash in the display; tap a white or grey object to position the spot white balance target (□) over the selected object and measure white balance. To zoom in on the target for precise positioning, press the **+** button. Press the **WB** button again to exit direct measurement mode.



White balance presets d1–d6 can be viewed by selecting **Preset manual** for **White balance** in the movie shooting menu. The white balance target is shown on the preset.

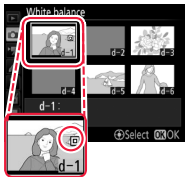

● **Active D-Lighting** **CHECK IT OUT** ✓

Use Active D-Lighting to preserve details in highlights and shadows when filming high-contrast scenes, for example when shooting through a window or at the beach.

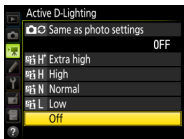

Matrix metering is recommended. Active D-Lighting does not apply at high ISO sensitivities (Hi 0.3–Hi 5) or at a frame size of 3840 × 2160. If **Same as photo settings** is selected for **Active D-Lighting** in the movie shooting menu and **Auto** is selected in the photo shooting menu, movies will be shot at a setting equivalent to **Normal**.

● **Microphone Sensitivity**

Adjust settings for the built-in stereo microphone or optional ME-1 stereo or ME-W1 wireless microphones. Choose **Auto sensitivity** to adjust sensitivity automatically, **Microphone off** to turn sound recording off. To select sensitivity manually, select **Manual sensitivity** and choose a value between 1 and 20 (higher values indicate increased sensitivity).

● **Frequency Response**

If **WIDE Wide range** is selected, the built-in microphone will respond to a wide range of frequencies, from music to the bustling hum of a city street. Choose **VOICE Vocal range** to bring out human voices.

● **Wind Noise Reduction**

Select **On** to enable the low-cut filter for the built-in microphone (optional stereo microphones are unaffected), reducing noise produced by wind blowing over the microphone (note that other sounds may also be affected). Wind-noise reduction for optional stereo microphones that support this feature can be enabled or disabled using microphone controls.

More on Movies

Read this section for information on functions you may find useful when filming movies.

● The Information Display

To hide or display indicators in the monitor, press the **info** button.

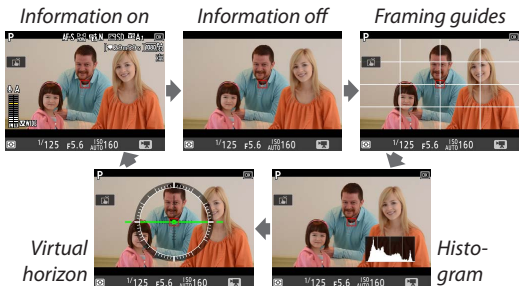

Warnings

Temperature warning (displayed in red 30 s before live view ends)

Low battery

No memory card



Indicators

The indicators at right appear in the information display in movie mode (in live view and during recording).

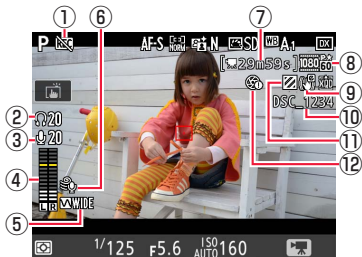

- ① **"No movie" indicator:** Indicates that movies can not be recorded.
- ② **Headphone volume:** Volume of audio output to headphones. Displayed when third-party headphones are connected.
- ③ **Microphone sensitivity:** Microphone sensitivity.
- ④ **Sound level:** Sound level for audio recording. Displayed in red if level is too high; adjust microphone sensitivity accordingly.
- ⑤ **Frequency response:** The current frequency response.
- ⑥ **Wind noise reduction:** Displayed when wind noise reduction is on.
- ⑦ **Time remaining:** The recording time available for movies.
- ⑧ **Movie frame size:** The frame size for movie recording.
- ⑨ **Electronic VR indicator:** Displayed when electronic vibration reduction is on.
- ⑩ **File name:** The file name for the current movie ([page 8](#)).
- ⑪ **Highlight display indicator:** Appears when the highlight display is on.
- ⑫ **"No power aperture" indicator:** Indicates that power aperture is unavailable.

● Custom Control Assignments **CHECK IT OUT** ✓

Use Custom Setting g1 (Custom control assignment) to choose the roles played by camera controls during movie recording.

Press

To choose the roles played by the following controls, highlight an option and press the center of the multi selector:

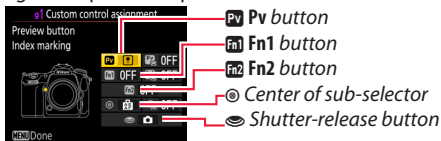

The functions that can be assigned to these controls are:

	Pv	Fn1	Fn2	⊙	☺
⊙ Power aperture (open)	✓	—	—	—	—
⊙ Power aperture (close)	—	✓	—	—	—
⊕ Exposure compensation +	✓	—	—	—	—
⊖ Exposure compensation -	—	✓	—	—	—
📍 Index marking	✓	✓	✓	✓	—
📷 View photo shooting info	✓	✓	✓	✓	—
🔒 AE/AF lock	—	—	—	✓	—
🔒 AE lock only	—	—	—	✓	—
🔒 AE lock (Hold)	—	—	—	✓	—
🔒 AF lock only	—	—	—	✓	—
📷 Take photos	—	—	—	—	✓
🎥 Record movies	—	—	—	—	✓

	Pv	Fn1	Fn2	⊙	☰
None	✓	✓	✓	✓	—

Power Aperture

Power aperture is available only in exposure modes **A** and **M** and can not be used while photo shooting info is displayed (a  icon indicates that power aperture can not be used). The display may flicker while aperture is adjusted.

Press + 

To choose the roles played by the following controls in combination with the command dials, highlight an option and press the center of the multi selector:

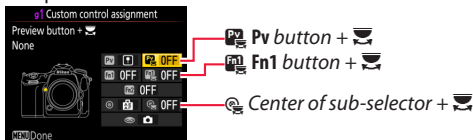

Choose from  Choose image area and None.

Silent Exposure Compensation

At default settings, exposure compensation can be adjusted by pressing the  button and rotating the main command dial. The sound of the dial may however be audible in the audio recorded with movies.

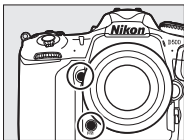

This can be prevented by using Custom Setting g1 (**Custom control assignment**) to assign **Exposure compensation +** to the **Pv** button and **Exposure compensation -** to the **Fn1** button. Exposure compensation can then be adjusted by pressing and holding one or the other of these buttons instead of rotating the main command dial.

Exposure Lock

To lock exposure when filming in **P**, **S**, or **A** mode or when auto ISO sensitivity control is enabled, assign **AE-L lock (Hold)** to the center of the sub-selector. Exposure will lock when the center of the sub-selector is pressed and remain locked until it is pressed again. Exposure lock will

Center of sub-selector

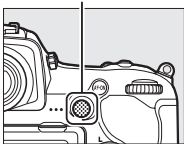

not be interrupted if the shutter-release button is pressed all the way down to take photographs during filming.

Starting Recording with the Shutter-Release Button

If **Record movies** is assigned to the shutter-release button and the live view selector is rotated to , you can start live view by pressing the shutter-release button halfway and start and end recording by pressing it all the way down. To prevent camera shake, you can mount the camera on a tripod and start and end recording using an optional remote cord (such as the MC-36A or MC-30A) or wireless remote controller (such as the WR-R10/WR-T10).

To prevent unintended operation of the  button, select **Disable** for Custom Setting f8 (**Live view button options**).









● **Electronic Vibration Reduction** *CHECK IT OUT* ✓

To enable electronic vibration reduction in movie mode, select **On** for **Electronic VR** in the movie shooting menu. Electronic vibration reduction is best with hand-held cinematography; select **Off** when the camera is on a tripod. Note that if electronic vibration reduction is on and **DX** is selected for **Choose image area** ([page 9](#)), the angle of view will be reduced and the edges of the frame cropped out.

Electronic vibration reduction is not available at a frame size of 3840 × 2160 ([page 8](#)). Regardless of the option chosen for **ISO sensitivity settings > ISO sensitivity (mode M)** in the movie shooting menu ([page 10](#)), the upper limit when electronic vibration reduction is on is ISO 51200.

● The Movie *i*-Button Menu

Pressing the *i* button in movie mode displays the following options:

- **Choose image area:** Choose an image area for movie recording ([page 9](#)).
- **Frame size/frame rate:** Select a frame size and rate ([page 8](#)).
- **Active D-Lighting:** Adjust Active D-Lighting for movies recorded at frame sizes other than 3840 × 2160 ([page 8](#)).
- **Movie quality:** Choose movie quality.
- **Microphone sensitivity:** Press  or  to adjust microphone sensitivity ([page 13](#)).
- **Frequency response:** Control the frequency response of the built-in microphone ([page 13](#)).
- **Wind noise reduction:** Enable or disable wind noise reduction using the built-in microphone's low-cut filter ([page 14](#)).
- **Destination:** When two memory cards are inserted, you can choose the card to which movies are recorded.
- **Monitor brightness:** Press  or  to adjust monitor brightness (note that this affects live view only and has no effect on photographs or movies or on the brightness of the monitor for menus or playback).
- **Multi-selector power aperture:** Select **Enable** to enable power aperture. Press  to widen the aperture,  to narrow the aperture.
- **Highlight display:** Choose whether the brightest areas of the frame (highlights) are shown by slanting lines in the display.
- **Headphone volume:** Press  or  to adjust headphone volume.
- **Electronic VR:** Enable or disable electronic vibration reduction in movie mode ([page 20](#)).

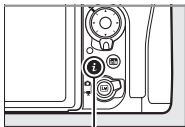

i button

● White Balance

In movie mode, white balance can be set by pressing the **WB** button and rotating a command dial.

The Main Command Dial

Choose a white balance option. The effect can be previewed in the monitor.

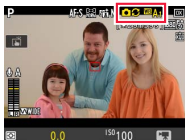

The Sub-command Dial

Fine-tune white balance on the amber (A)–blue (B) axis in increments of 0.5.

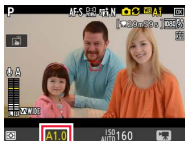

If **[K]** (**Choose color temp.**) is selected for white balance, you can choose a color temperature by pressing the **WB** button and rotating the sub-command dial (adjustments are made in mireds), or enter a color temperature by pressing and holding the **WB** button and using **[←]** and **[→]** to highlight digits and **[↑]** and **[↓]** to edit.

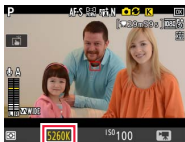

If **Preset manual** is selected for white balance, you can use the **WB** button and sub-command dial to choose a preset.

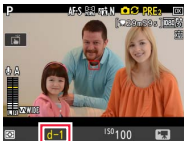

● Choosing a Picture Control in Live View

To choose a Picture Control in live view, press the **Fn** (**[Pict.]/?**) button. The effect of the selected control can be previewed in the monitor.



To modify the selected control, press



● Taking Photos **CHECK IT OUT** ✓

In movie mode, photos can be taken by keeping the shutter-release button pressed all the way down (note that photos will not be taken if the camera is unable to focus). If filming is in progress, recording will end and any footage shot to that point will be saved. The photos will have an aspect ratio of 16:9; size varies with the option selected for movie frame size and, in the case of photos taken at frame sizes of 1920 × 1080 and 1280 × 720, with the image area and the option selected for **Image size** > **JPEG/TIFF** in the photo shooting menu.

Frame size	Image area	Image size	Photo size (pixels)
3840 × 2160	—		3840 × 2160
1920 × 1080 1280 × 720	DX	Large	5568 × 3128
		Medium	4176 × 2344
		Small	2784 × 1560
	1.3×	Large	4272 × 2400
		Medium	3200 × 1800
		Small	2128 × 1192

● Creating Stills from 4K UHD Movies



During movie playback, you can use **Save selected frame** to save selected frames of 4K UHD movies as JPEG images.

1 Pause playback on the desired frame.

Press  to pause playback.



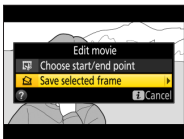

2 Choose **Save selected frame**.

Press  or , then highlight **Save selected frame** and press .



3 Create a still copy.

Press  to create a fine★-quality JPEG copy of the current frame. A confirmation dialog will be displayed; highlight **Yes** and press .

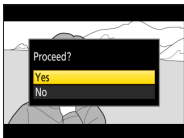

Save Selected Frame

Movie stills lack some photo information and can not be re-touched.

● HDMI Output

The camera can be connected to HDMI devices for high-definition movie playback and recording.

Connecting to an HDMI Device

The camera can be connected to high-definition video devices using an optional High-Definition Multimedia Interface (HDMI) cable or a third-party type C HDMI cable. Always turn the camera off before connecting or disconnecting the cable.

Connect to high-definition device (choose cable with appropriate connector)

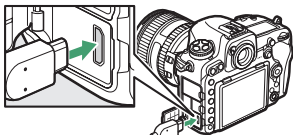

Connect to camera

Tune the device to the HDMI input channel, then turn the camera on and press the  button. During playback, images will be displayed on the television screen. Volume can be adjusted using television controls; the camera controls can not be used.

If the camera is connected to a third-party HDMI video recorder, you can film movies and save them directly to the device even if no memory card is inserted in the camera.

The HDMI Cable Clip

When using the optional Nikon HDMI cable, attach the supplied clip as shown to prevent accidental disconnection. Do not use cable clips with non-Nikon cables.

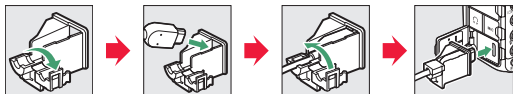

HDMI Options

The **HDMI** option in the setup menu controls output resolution and offers a variety of advanced HDMI options.

Output Resolution

Choose the format for images output to the HDMI device. If **Auto** is selected, the camera will automatically select the appropriate format.

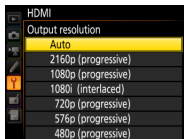

Advanced

Selecting **Advanced** displays the following options:

- **Output range:** **Auto** is recommended in most situations. If the camera is unable to determine the correct setting, you can choose an option based on the device's video signal input color range. If the input range is 16 to 235 or contrast is so high that highlights are "washed out" (too bright) and shadows too dark, choose **Limited range**. Choose **Full range** if the input range is 0 to 255 or if contrast is so low that shadows are "washed out".
- **Output display size:** Horizontal and vertical frame coverage for HDMI output can be set to 95% or 100%. Choose 100% when recording video to an external device.
- **Live view on-screen display:** If **Off** is selected, the external device will not display shooting information during live view photography.
- **Dual monitor:** Choose **On** to mirror the HDMI display on the camera monitor, **Off** to turn the camera monitor off to save power. **Dual monitor** turns on automatically when **Live view on-screen display** is **Off**.

Time-Lapse Movies

Time-lapse movies can be created from photos shot using time-lapse photography, the interval timer, or unlimited continuous release. In the first case, the camera generates the movie automatically, while the last two methods require third-party movie-editing software, a powerful computer, and advanced image-processing skills.

● Time-Lapse Movie Techniques

The three methods of creating time-lapse movies are compared below.

Interval-Timer Photography

In interval-timer photography, the camera takes photos at preset intervals. Image quality, size, and other settings can be adjusted for exactly the results you want, while shots containing unwanted objects can be edited or deleted. You can create frames for high-quality movies and even (in NEF/RAW format) choose the color temperature.

Time-Lapse Photography

This is the least complicated method: the camera creates movies from photos taken at preset intervals, sparing you the task of splicing the shots together. You are however limited to the frame sizes, bit rates, and quality options available in the **Frame size/frame rate** and **Movie quality** menus and can record movies in MOV format only. In addition, the individual frames that make up the movie are not stored in separate files.

Unlimited Continuous Release

Selecting a shutter speed of 4 s or slower in exposure mode **S** or **M** lets you take an unlimited number of photographs in continuous release mode (**CL**, **CH**, or **QC**): shooting can continue as long as the battery lasts and there is space on the memory card, regardless of the option selected for Custom Setting d2 (**Max. continuous release**). Although the lack of shutter speeds faster than 4 s limits your choice of subjects, the interval between shots is as short as in normal photography, producing smoother footage of subjects that require exposure times of 4 s or more, such as stars or auroras.

● **Table: Time-Lapse Movie Techniques Compared**

		Interval timer	Time lapse	Continuous
Format	Stills	NEF, JPEG, TIFF	—	NEF, JPEG, TIFF
	Movies	—	MOV	—
Max. frame size		5568 × 3712	3840 × 2160	5568 × 3712
Time between shots		0.5 s or more	1 s or more	Time selected in CL or CH mode
Exposure time		$\frac{1}{8000}$ –30 s		4–30 s
Creates		Material for advanced time-lapse movies and film logs	Hassle-free time-lapse movies	Material for time-lapse movies featuring star trails or auroras

● Filming 4K UHD Time-Lapse Movies

Filming 4K UHD time-lapse movies is simple: just select a frame size of 3840 × 2160 for **Frame size/frame rate** in the movie shooting menu and then follow the steps below. The crop ([page 9](#)) is the same as for 4K UHD movies.

1 Adjust time-lapse movie settings.

Select **Time-lapse movie** in the movie shooting menu and adjust the following settings:

- **Interval:** The interval (in minutes and seconds) should be longer than the slowest anticipated shutter speed.



Highlight Interval and press .

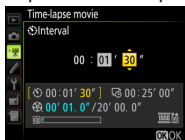



Choose an interval and press .

- **Shooting time:** The total shooting time (in hours and minutes) can be up to 7 hours and 59 minutes.

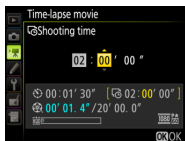

Highlight Shooting time and press .



Choose a shooting time and press .

- **Exposure smoothing:** Select **On** to smooth abrupt changes in exposure in modes other than **M** (note that exposure smoothing only takes effect in mode **M** if auto ISO sensitivity control is enabled in the photo shooting menu).

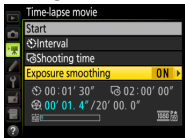

Highlight **Exposure smoothing** and press **↵**.

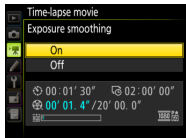

Highlight an option and press **OK**.

2 Start shooting.

Highlight **Start** and press **OK**. After about 3 s, shooting will start and the camera will take photographs at the selected interval for the selected shooting time. To end shooting early and create a time-lapse movie from the frames shot to that point, highlight **Off** in the time-lapse movie menu and press **OK**, or press **OK** between frames or immediately after a frame is recorded.

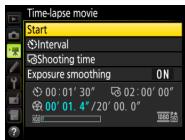

Things to Note

Some things to note when filming:

● Restrictions on Available Settings

The exposure settings available in movie mode (in live view or during recording) vary with the exposure mode selected.

	Aperture	Shutter speed	ISO sensitivity
P, S	—	—	— ^{1,2}
A	✓	—	— ^{1,2}
M	✓	✓	✓ ^{2,3}

1. The upper limit for ISO sensitivity can be selected using the **ISO sensitivity settings > Maximum sensitivity** option in the movie shooting menu ([page 10](#)).
2. The upper limit when **On** is selected for **Electronic VR** in the movie shooting menu is ISO 51200.
3. If **On** is selected for **ISO sensitivity settings > Auto ISO control (mode M)** in the movie shooting menu, the upper limit for ISO sensitivity can be selected using the **Maximum sensitivity** option.

● Keeping the Camera Cool

If live view is used continuously for extended periods, the camera's internal temperature will rise, causing noise (bright spots, randomly-spaced bright pixels, or fog) to appear in images. Use live view only when taking pictures. Note that live view does not end when menus are displayed; unless you intend to resume shooting immediately, exit live view before using the menus.

● **Image Artifacts**

Flicker, banding, or distortion may be visible in the monitor and in the final movie under fluorescent, mercury vapor, or sodium lamps, when power aperture is in use, or if the camera is panned horizontally or an object moves at high speed through frame. Jagged edges, color fringing, moiré, and bright spots may also appear. Bright areas or bands may appear with flashing signs and other intermittent light sources or if the subject is briefly illuminated by a strobe or other bright, momentary light source. Noise (randomly-spaced bright pixels, fog, or lines) and unexpected colors may be more noticeable if you zoom in on the view through the lens during live view.

The **Flicker reduction** option in the movie shooting menu can be used to reduce flicker under fluorescent, mercury vapor, or sodium lamps. The desired results may not be obtained if the subject is very bright, in which case you should try a smaller aperture (higher f-number).

● **Ending Recording**

If the maximum length is reached, the memory card fills, the battery runs low, the live view selector is rotated to , the lens is removed, or the camera overheats, filming will end automatically and all footage shot to that point will be saved. No movie will be recorded if the battery is removed during filming.

Movie Playback Tips and Tricks

Some tips for viewing movies:

- **Ten-Second Advance/Rewind**

Rotate the main command dial one click to advance or rewind 10 seconds.

- **Skipping to an Index or the Last/First Frame**

If you added index markers during recording, you can skip to the next or previous index frame by rotating the sub-command dial during playback. If there are no intervening index markers, the sub-command dial will take you to the last or first frame.

- **Slow Motion**

Press  for slow-motion playback.

Index Marking

If **Index marking** is assigned to a control using Custom Setting g1 (**Custom control assignment**, [page 17](#)), you can press the selected control during recording to add indices that can be used to locate frames during editing and playback. Up to 20 indices can be added to each movie.



● Using the Touch Screen

The touch screen offers the following movie playback controls:

Play/Pause/Resume

Tap the  icon to start playback and tap the monitor to pause or resume.





Skip

Tap the progress bar to skip to the selected position and pause playback. You may find this useful when attempting to find a specific scene in a long movie.



Volume Control

Tap the  or  icon during playback to adjust the volume.



Joining Movie Files Together **CHECK IT OUT** ✓

Each movie recorded with the D500 may consist of up to 8 files of up to 4 GB in size. These files can be joined together in ViewNX-i.

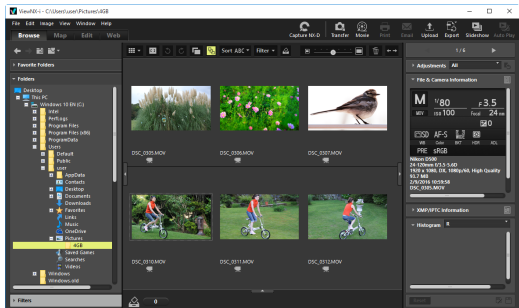

1 Select the files in the movie.

Right-click any of the files in the movie and choose **Select Set of Continuous Movies** to select all the movie's component files.

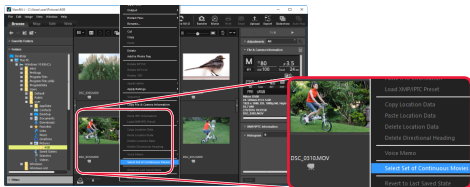

- 2** **Launch ViewNX-Movie Editor.**
Click the  (movie) button to launch ViewNX-Movie Editor.

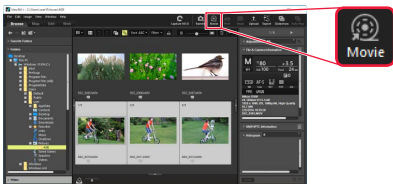

- 3** **Click Combine movies.**
The options at right will be displayed. Click **Combine Movies**.

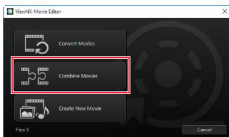

- 4** **Save the movie.**
Choose a destination and file name and click **Output**.

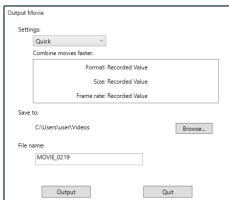

D500 Movie Specifications

Image sensor

Image sensor	23.5 × 15.7 mm CMOS sensor
Total pixels	21.51 million
Dust-reduction system	Image sensor cleaning, Image Dust Off reference data (Capture NX-D software required)

Storage

Media	XQD memory cards; SD (Secure Digital) and UHS-II compliant SDHC and SDXC memory cards
-------	---

Movies

Metering	TTL exposure metering using main image sensor
Metering method	Matrix, center-weighted, or highlight-weighted
Frame size (pixels) and frame rate	<ul style="list-style-type: none">• 3840 × 2160 (4K UHD); 30p (progressive), 25p, 24p• 1920 × 1080; 60p, 50p, 30p, 25p, 24p• 1280 × 720; 60p, 50p Actual frame rates for 60p, 50p, 30p, 25p, and 24p are 59.94, 50, 29.97, 25, and 23.976 fps respectively; ★ high quality available at all frame sizes, normal quality available at all sizes except 3840 × 2160
Bit rate	<ul style="list-style-type: none">• 3840 × 2160 (4K UHD): 144 Mbps• 1920 × 1080 60p/50p ★ high: 48 Mbps• 1920 × 1080 60p/50p normal: 24 Mbps• 1920 × 1080 30p/25p/24p ★ high: 24 Mbps• 1920 × 1080 30p/25p/24p normal: 12 Mbps• 1280 × 720 ★ high: 24 Mbps• 1280 × 720 normal: 12 Mbps
Sampling rate	<ul style="list-style-type: none">• Internal storage: 4:2:0, 8 bit• HDMI output: 4:2:2, 8 bit

Movies

File format	MOV
Video compression	H.264/MPEG-4 Advanced Video Coding
Audio recording format	48 kHz, 16-bit linear PCM
Audio recording device	Built-in stereo microphone; external microphone (impedance 2.2K Ω); sensitivity adjustable
ISO sensitivity	<ul style="list-style-type: none">• Exposure mode M: Auto ISO sensitivity control (ISO 100 to Hi 5) available with selectable upper limit; manual selection (ISO 100 to 51200 in steps of $\frac{1}{3}$, $\frac{1}{2}$, or 1 EV) with additional options available equivalent to approximately 0.3, 0.5, 0.7, 1, 2, 3, 4, or 5 EV (ISO 1640000 equivalent) above ISO 51200• Exposure modes P, S, and A: Auto ISO sensitivity control (ISO 100 to Hi 5) with selectable upper limit
Active D-Lighting	Can be selected from Same as photo settings, Extra high, High, Normal, Low, or Off
Other options	Index marking, time-lapse movies, electronic vibration reduction

White balance	Same as photo settings, auto (3 types), incandescent, fluorescent (7 types), direct sunlight, cloudy, shade, preset manual (up to 6 values can be stored, spot white balance measurement available during live view), choose color temperature (2500 K–10000 K), all with fine-tuning.
----------------------	--

Picture Control

Picture Control System	Same as photo settings, Standard, Neutral, Vivid, Monochrome, Portrait, Landscape, Flat; selected Picture Control can be modified; storage for custom Picture Controls
------------------------	--

Monitor	8-cm/3.2-in., approx. 2359k-dot (XGA) tilting TFT touch-sensitive LCD with 170 ° viewing angle, approximately 100% frame coverage, and manual monitor brightness control
----------------	--

Interface

USB	SuperSpeed USB (USB 3.0 Micro-B connector); connection to built-in USB port is recommended
HDMI output	Type C HDMI connector
Audio input	Stereo mini-pin jack (3.5mm diameter; plug-in power supported)
Audio output	Stereo mini-pin jack (3.5 mm diameter)

Power source

Battery	One rechargeable Li-ion EN-EL15 battery
Battery pack	Optional MB-D17 multi-power battery pack with one rechargeable Nikon EN-EL18a or EN-EL18 Li-ion battery (available separately), one rechargeable Nikon EN-EL15 Li-ion battery, or eight AA alkaline, Ni-MH, or lithium batteries. A BL-5 battery-chamber cover is required when using EN-EL18a or EN-EL18 batteries.
AC adapter	EH-5b AC adapter; requires EP-5B power connector (available separately)

Tripod socket	¼ in. (ISO 1222)
----------------------	------------------

Nikon