

Nikon

En

The Nikon Guide to Digital Photography
with the

D80

DIGITAL CAMERA

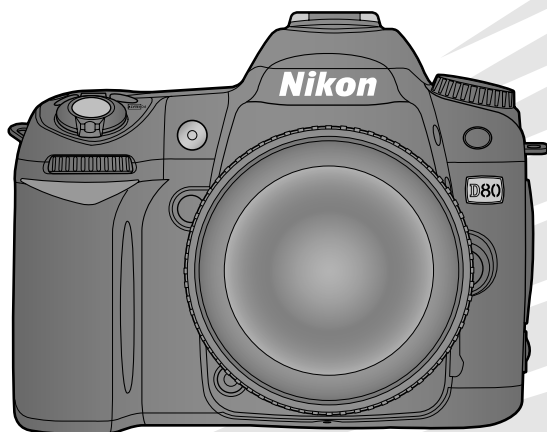

CE

Where to Find It

Find what you're looking for from:



The Table of Contents



See pages v–vi

Find items by function or menu name.



The Q&A Index



See pages vii–ix

Know what you want to do but don't know the function name? Find it from the "question and answer" index.



The Index



See pages 147–149

Search by key word.



Error Messages



See pages 132–133

If a warning is displayed in the control panel, viewfinder, or monitor, find the solution here.



Troubleshooting



See pages 129–131

Camera behaving unexpectedly? Find the solution here.

Digitutor

"Digitutor," a series of "watch and learn" manuals in movie form, is available at the following website:

http://www.nikondigitutor.com/index_eng.html

Help

Use the camera's on-board help feature for help on menu items and other topics. See page 9 for details.

Introduction



Tutorial

Photography and Playback



Reference

More on Photography (All Modes)



P, S, A, and M Modes



More on Playback



Connecting to a Television, Computer, or Printer



Menu Guide

Playback Options: The Playback Menu



Shooting Options: The Shooting Menu



Custom Settings



Basic Camera Settings: The Setup Menu



Creating Retouched Copies: The Retouch Menu



Technical Notes



For Your Safety

To prevent damage to your Nikon product or injury to yourself or to others, read the following safety precautions in their entirety before using this equipment. Keep these safety instructions where all those who use the product will read them.

The consequences that could result from failure to observe the precautions listed in this section are indicated by the following symbol:



This icon marks warnings. To prevent possible injury, read all warnings before using this Nikon product.

WARNINGS



Keep the sun out of the frame

Keep the sun well out of the frame when shooting backlit subjects. Sunlight focused into the camera when the sun is in or close to the frame could cause a fire.



Do not look at the sun through the viewfinder

Viewing the sun or other strong light source through the viewfinder could cause permanent visual impairment.



Using the viewfinder diopter control

When operating the viewfinder diopter control with your eye to the viewfinder, care should be taken not to put your finger in your eye accidentally.



Turn off immediately in the event of malfunction

Should you notice smoke or an unusual smell coming from the equipment or AC adapter (available separately), unplug the AC adapter and remove the battery immediately, taking care to avoid burns. Continued operation could result in injury. After removing the battery, take the equipment to a Nikon-authorized service center for inspection.



Do not disassemble

Touching the product's internal parts could result in injury. In the event of malfunction, the product should be repaired only by a qualified technician. Should the product break open as the result of a fall or other accident, remove the battery and/or AC adapter and then take the product to a Nikon-authorized service center for inspection.



Do not use in the presence of flammable gas

Do not use electronic equipment in the presence of flammable gas, as this could result in explosion or fire.



Keep out of reach of children

Failure to observe this precaution could result in injury.



Do not place the strap around the neck of an infant or child

Placing the camera strap around the neck of an infant or child could result in strangulation.



Observe proper precautions when handling batteries

Batteries may leak or explode if improperly handled.

Observe the following precautions when handling batteries for use in this product:

- Use only batteries approved for use in this equipment.
- Do not short or disassemble the battery.
- Be sure the product is off before replacing the battery. If you are using an AC adapter, be sure it is unplugged.
- Do not attempt to insert the battery upside down or backwards.
- Do not expose the battery to flame or to excessive heat.
- Do not immerse in or expose to water.
- Replace the terminal cover when transporting the battery. Do not transport or store the battery with metal objects such as necklaces or hairpins.
- Batteries are prone to leakage when fully discharged. To avoid damage to the product, be sure to remove the battery when no charge remains.
- When the battery is not in use, attach the terminal cover and store in a cool, dry place.
- The battery may be hot immediately after use or when the product has been used on battery power for an extended period. Before removing the battery turn the camera off and allow the battery to cool.
- Discontinue use immediately should you notice any changes in the battery, such as discoloration or deformation.



Observe proper precautions when handling the quick charger

- Keep dry. Failure to observe this precaution could result in fire or electric shock.
- Dust on or near the metal parts of the plug should be removed with a dry cloth. Continued use could result in fire.
- Do not handle the power cable or go near the charger during thunderstorms. Failure to observe this precaution could result in electric shock.
- Do not damage, modify, or forcibly tug or bend the power cable. Do not place it under heavy objects or expose it to heat or flame. Should the insulation be damaged and the wires become exposed, take the power cable to a Nikon-authorized service representative for inspection. Failure to observe this precaution could result in fire or electric shock.

- Do not handle the plug or charger with wet hands. Failure to observe this precaution could result in electric shock.



Use appropriate cables

When connecting cables to the input and output jacks, use only the cables provided or sold by Nikon for the purpose to maintain compliance with product regulations.



CD-ROMs

CD-ROMs containing software or manuals should not be played back on audio CD equipment. Playing CD-



Avoid contact with liquid crystal

Should the monitor break, care should be taken to avoid injury due to broken glass and to prevent the liquid crystal from the monitor touching the skin or entering the eyes or mouth.

ROMs on an audio CD player could cause hearing loss or damage the equipment.



Observe caution when using the flash

Do not operate the flash with the flash window touching a person or object. Failure to observe this precaution could result in burns or fire.

Using the flash close to the subject's eyes could cause temporary visual impairment. Particular care should be observed when photographing infants, when the flash should be no less than one meter (39 in.) from the subject.

Notices

- No part of the manuals included with this product may be reproduced, transmitted, transcribed, stored in a retrieval system, or translated into any language in any form, by any means, without Nikon's prior written permission.
- Nikon reserves the right to change the specifications of the hardware and software described in these manuals at any time and without prior notice.
- Nikon will not be held liable for any damages resulting from the use of this product.
- While every effort has been made to ensure that the information in these manuals is accurate and complete, we would appreciate it were you to bring any errors or omissions to the attention of the Nikon representative in your area (address provided separately).

Notices for Customers in the U.S.A.

Federal Communications Commission (FCC) Radio Frequency Interference Statement

This equipment has been tested and found to comply with the limits for a Class B digital device, pursuant to Part 15 of the FCC rules. These limits are designed to provide reasonable protection against harmful interference in a residential installation. This equipment generates, uses, and can radiate radio frequency energy and, if not installed and used in accordance with the instructions, may cause harmful interference to radio communications. However, there is no guarantee that interference will not occur in a particular installation. If this equipment does cause harmful interference to radio or television reception, which can be determined by turning the equipment off and on, the user is encouraged to try to correct the interference by one or more of the following measures:

- Reorient or relocate the receiving antenna.
- Increase the separation between the equipment and receiver.
- Connect the equipment into an outlet on a circuit different from that to which the receiver is connected.
- Consult the dealer or an experienced radio/television technician for help.



CAUTIONS

Modifications

The FCC requires the user be notified that any changes or modifications made to this device that are not expressly approved by Nikon Corporation may void the user's authority to operate the equipment.

Interface Cables

Use the interface cables sold or provided by Nikon for your equipment. Using other interface cables may exceed the limits of Class B Part 15 of the FCC rules.

Notice for Customers in the State of California

WARNING: Handling the cord on this product may expose you to lead, a chemical known to the State of California to cause birth defects or other reproductive harm. *Wash hands after handling.*

Nikon Inc., 1300 Walt Whitman Road, Melville, New York 11747-3064, U.S.A. Tel.: 631-547-4200

Notices for Customers in Canada

CAUTION

This class B digital apparatus meets all requirements of the Canadian Interference Causing Equipment Regulations.

ATTENTION

Cet appareil numérique de la classe B respecte toutes les exigences du Règlement sur le matériel brouilleur du Canada.

Symbol for Separate Collection in European Countries

This symbol indicates that this product is to be collected separately.



The following apply only to users in European countries:

- This product is designated for separate collection at an appropriate collection point. Do not dispose of as household waste.
- For more information, contact the retailer or the local authorities in charge of waste management.

Notice Concerning Prohibition of Copying or Reproduction

Note that simply being in possession of material that has been digitally copied or reproduced by means of a scanner, digital camera, or other device may be punishable by law.

• Items prohibited by law from being copied or reproduced

Do not copy or reproduce paper money, coins, securities, government bonds, or local government bonds, even if such copies or reproductions are stamped "Sample."

The copying or reproduction of paper money, coins, or securities which are circulated in a foreign country is prohibited.

Unless the prior permission of the government has been obtained, the copying or reproduction or unused postage stamps or post cards issued by the government is prohibited.

The copying or reproduction of stamps issued by the government and of certified documents stipulated by law is prohibited.

• Cautions on certain copies and reproductions

The government has issued cautions on copies or reproductions of securities issued by private companies (shares, bills, checks, gift certificates, etc.), commuter passes, or coupon tickets, except when a minimum of necessary copies are to be provided for business use by a company. Also, do not copy or reproduce passports issued by the government, licenses issued by public agencies and private groups, ID cards, and tickets, such as passes and meal coupons.

• Comply with copyright notices

The copying or reproduction of copyrighted creative works such as books, music, paintings, woodcuts, prints, maps, drawings, movies, and photographs is governed by national and international copyright laws. Do not use this product for the purpose of making illegal copies or to infringe copyright laws.

Disposing of Data Storage Devices

Please note that deleting images or formatting memory cards or other data storage devices does not completely erase the original image data. Deleted files can sometimes be recovered from discarded storage devices using commercially available software, potentially resulting in the malicious use of personal image data. Ensuring the privacy of such data is the user's responsibility.

Before discarding a data storage device or transferring ownership to another person, erase all data using commercial deletion software, or format the device and then completely refill it with images containing no private information (for example, pictures of empty sky). Be sure to also replace any pictures selected for preset white balance. Care should be taken to avoid injury when physically destroying data storage devices.

Trademark Information

Macintosh, Mac OS, and QuickTime are registered trademarks of Apple, Inc. Microsoft, Windows, and Windows Vista are either registered trademarks or trademarks of Microsoft Corporation in the United States and/or other countries. The SD logo is a trademark of the SD Card Association. The SDHC logo is a trademark. Adobe, Acrobat, and Adobe Reader are registered trademarks of Adobe Systems Inc. PictBridge is a trademark. All other trade names mentioned in this manual or the other documentation provided with your Nikon product are trademarks or registered trademarks of their respective holders.

Table of Contents

For Your Safety	ii
Notices	iii
Q & A Index	vii
Introduction	1
Getting to Know the Camera	2
Using Camera Menus	9
First Steps	11
Attaching a Lens	11
Charging and Inserting the Battery	12
Basic Setup	14
Inserting Memory Cards	15
Adjusting Viewfinder Focus	17
Tutorial	18
“Point-and-Shoot” Photography (AUTO Mode)	19
Creative Photography (Digital Vari-Programs) ...	24
Portrait	25
Landscape	25
Close up	25
SportsAutofocus	25
Night landscape	25
Night portrait	25
Basic Playback	26
Reference	27
More on Photography (All Modes)	28
Focus	28
Autofocus	28
Focus Area Selection	30
Focus Lock	31
Manual Focus	32
Image Quality and Size	33
Image Quality	34
Image Size	35
Choosing a Shooting Mode	36
Self-Timer Mode (⏱)	37
Using a Remote Control (📡)	38
Using the Built-in Flash	40
ISO Sensitivity	43
Two-Button Reset	44
P, S, A, and M Modes	45
Mode P (Programmed Auto)	47
Mode S (Shutter-Priority Auto)	48
Mode A (Aperture-Priority Auto)	49
Mode M (Manual)	50
Exposure	52
Metering	52
Autoexposure Lock	53
Exposure Compensation	54
Flash Exposure Compensation	55
Bracketing	56
White Balance	58
Fine-Tuning White Balance	58
Choosing a Color Temperature	59
Preset White Balance	59
More on Playback	61
Viewing Photographs on the Camera	61
Photo Information	62
Viewing Multiple Images: Thumbnail Playback	63
Taking a Closer Look: Playback Zoom	64
Protecting Photographs from Deletion	65
Deleting Individual Photographs	65
Connecting to a TV, Computer, or Printer ...66	
Viewing Photographs on TV	66
Connecting to a Computer	67
Before Connecting the Camera	67
Connecting the USB Cable	67
Printing Photographs	69
Printing Via Direct USB Connection	69
Menu Guide	74
Playback Options: The Playback Menu	74
Delete	74
Playback Folder	75
Rotate Tall	75
Slide Show	75
Hide Image	78
Print Set	78
Shooting Options: The Shooting Menu	79
Optimize Image (P, S, A, and M Modes)	79
Image Quality (All Modes)	81
Image Size (All Modes)	81
White Balance (P, S, A, and M Modes)	82
ISO Sensitivity (All Modes)	83
Long Exp. NR (All Modes)	83
High ISO NR (All Modes)	83
Multiple Exposure (P, S, A, and M Modes)	84
Custom Settings	86
R: Reset	86
1: Beep (All Modes)	86
2: AF-Area Mode (All Modes)	87
3: Center AF Area (All Modes)	87
4: AF-Assist (All Modes Except 📷, 📡, and 📷)	87
5: No Memory Card? (All Modes)	88
6: Image Review (All Modes)	88
7: ISO Auto (P, S, A, and M Modes Only)	88
8: Grid Display (All Modes)	89
9: Viewfinder Warning (All Modes)	89
10: EV Step (All Modes)	89
11: Exposure Comp. (P, S, A, and M Modes Only) ...	89
12: Center-Weighted (P, S, A, and M Modes Only) ...	90
13: Auto BKT Set (P, S, A, and M Modes Only)	90
14: Auto BKT Order (P, S, A, and M Modes Only)	91

15: Command Dials (P, S, A, and M Modes Only)	91	File No. Sequence	106
16: FUNC Button (All Modes)	92	Mirror Lock-Up	106
17: Illumination (All Modes)	93	Dust Off Ref Photo	106
18: AE-L/AF-L (All Modes)	94	Battery Info	107
19: AE Lock (All Modes)	94	Firmware Version	108
20: Focus Area (All Modes)	94	Auto Image Rotation	108
21: AF Area Illumination (All Modes)	95	Creating Retouched Copies:	
22: Built-in Flash (P, S, A, and M Modes Only)	95	The Retouch Menu	109
23: Flash Warning (P, S, A, and M Modes Only)	98	D-Lighting	110
24: Flash Shutter Speed		Red-Eye Correction	111
(P, S, A, and M Modes Only)	98	Trim	111
25: Auto FP (P, S, A, and M Modes Only)	98	Monochrome	112
26: Modeling Flash (P, S, A, and M Modes Only)	98	Filter Effects	112
27: Monitor-Off (All Modes)	98	Small Picture	112
28: Auto Meter-Off (All Modes)	99	Image Overlay	114
29: Self-Timer (All Modes)	99	Technical Notes	116
30: Remote On Duration (All Modes)	99	Optional Accessories	116
31: Exp. Delay Mode (All Modes)	99	Lenses	117
32: MB-D80 Batteries (All Modes)	100	Optional Flash Units (Speedlights)	119
Basic Camera Settings: The Setup Menu	101	Other Accessories	122
CSM / Setup Menu	101	Caring for the Camera	124
Format Memory Card	102	Caring for the Camera and Battery: Cautions	127
World Time	103	Troubleshooting	129
LCD Brightness	103	Camera Error Messages and Displays	132
Video Mode	103	Appendix	134
Language	103	Specifications	142
USB	104	Index	147
Image Comment	104		
Folders	105		

Q & A Index

Find what you're looking for using this "question and answer" index.

General Questions

Question	Key phrase	Page #
How do I use the menus?	Using the menus	9–10
How do I get more information on a menu?	Help	3, 9
What do these indicators mean?	Control panel, viewfinder	5, 6
What does this warning mean?	Camera Error messages and displays	132–133
How many more shots can I take with this card?	Number of exposures remaining	19
How much charge does the battery have left?	Battery level	19
What does "exposure" mean and how does it work?	Exposure	46
What do I do with the viewfinder eyepiece cap?	Self timer, remote control	37, 38
What optional flash units (Speedlights) can I use?	Optional flash units	119–121
What lenses can I use?	Lenses	117–118
What accessories are available for my camera?	Accessories for the D80	123
What memory cards can I use?	Approved memory cards	122
What software is available for my camera?	Accessories for the D80	123
Who can I ask to repair or inspect my camera?	Servicing the camera	x, 126
How do I clean the camera or lens?	Cleaning the camera	124

Camera Setup

Question	Key phrase	Page #
How do I focus the viewfinder?	Viewfinder focus	17
How do I keep the monitor from turning off?	Monitor off	98
How do I set the clock?		
How do I set the clock for daylight savings time?	World time	103
How do I change time zones when I travel?		
How do I adjust monitor brightness?	LCD brightness	103
How do I restore default settings?	Two-button reset	44
How do I turn off the light on the front of the camera?	AF-assist illuminator	87
Can I display a framing grid in the viewfinder?	Grid display	89
How do I view the control panel in the dark?	LCD illuminator	3, 93
How do I keep the shutter speed and aperture displays from turning off?	Auto meter off	99
How do I change the self timer delay?	Self timer	99
How do I change the remote delay?	Remote control	99
How do I keep the camera from beeping?	Beep	86
How do I view all the items in the menus?	CSM / setup menu	101
Can I display the menus in a different language?	Language	103
How do I keep the file number from being reset when I insert a new memory card?	File number sequence	106
How do I reset file numbering to 1?		

Taking Photographs

Question	Key phrase	Page #
Is there an easy way to take snapshots?	Auto mode	19–23
Is there an easy way to take more creative shots?	Digital Vari-Program modes	24–25
How do I bring out a portrait subject?	Portrait mode	24, 25
How can I get good landscape shots?	Landscape mode	24, 25
How do I take close ups of small objects?	Close-up mode	24, 25
How do I “freeze” a moving subject?	Sports mode	24, 25
How do I shoot scenery at night?	Night landscape mode	24, 25
Can I include night backgrounds in my portraits?	Night portrait mode	24, 25
How do I take a lot of photographs quickly?	Shooting mode	36
Can I shoot a self-portrait?	Self timer	37
Is there a remote control for this camera?	Remote control	38–39
How do I adjust exposure?	Exposure; P , S , A , and M modes	45–51
How do I freeze or blur moving objects?	Mode S (shutter-priority auto)	48
How do I blur background details?	Mode A (aperture-priority auto)	49
Can I make photos brighter or darker?	Exposure compensation	54
How do I make a time exposure?	Long time-exposures	51
How do I use the flash?		
Can the flash fire automatically when needed?	Flash photography, flash mode	40–42
How do I keep the flash from firing?		
How do I prevent red eye?	Red-eye reduction	41
Can I take pictures under low light without the flash?	ISO sensitivity	43
Can I control how the camera focuses?	Autofocus	28–29
How do I focus on a moving subject?	Autofocus mode	29
How do I choose where the camera focuses?	Focus area	30
Can I change the composition after focusing?	Focus lock	31
How do I improve image quality?		
How do I take bigger photographs?	Image quality and size	33–35
How can I get more photos on the memory card?		
Can I take photos at a reduced size for e-mail?		

Viewing, Printing, and Retouching Photographs

Question	Key phrase	Page #
Can I view my photographs on the camera?	Camera playback	61, 63
Can I view more information about photos?	Photo info	62–63
Why parts of my photos blink?	Photo info, highlights	62–63, 131
How do I get rid of an unwanted photo?	Deleting individual photos	26, 65
Can I delete several photos at once?	Delete	74
Can I zoom in on pictures to make sure they're in focus?	Playback zoom	64
Can I protect photos from accidental deletion?	Protect	65
Is there an automatic playback ("slide show") option?	Slide show	75–77
Can I view my photos on TV?	Television playback	66
Can I set a slide show to music?	Pictmotion	75–77
How do I copy photos to my computer?	Connecting to a computer	67–68
How do I print photographs?	Printing photographs	69–73
Can I print photos without a computer?	Printing via USB	69–73
Can I print the date on my photographs?	Time stamp, DPOF	71, 73
How do I order professional prints?	Print set	73
How do I bring out details in shadows?	D-lighting	110
Can I get rid of red eye?	Red-eye correction	111
Can I crop photographs on the camera?	Trim	111
Can I create a monochrome copy of a photograph?	Monochrome	112
Can I create a copy with different colors?	Filter effects	112
Can I make a small copy of a photograph?	Small picture	112–113
Can I overlay two photos to make a single image?	Image overlay	114–115

Life-Long Learning

As part of Nikon's "Life-Long Learning" commitment to ongoing product support and education, continually-updated information is available on-line at the following sites:

- For users in the U.S.A.: <http://www.nikonusa.com/>
- For users in Europe and Africa: <http://www.europe-nikon.com/support>
- For users in Asia, Oceania, and the Middle East: <http://www.nikon-asia.com/>







Visit these sites to keep up-to-date with the latest product information, tips, answers to frequently-asked questions (FAQs), and general advice on digital imaging and photography. Additional information may be available from the Nikon representative in your area. See the following URL for contact information: <http://nikonimaging.com/>

Introduction



Thank you for your purchase of a Nikon D80 single-lens reflex (SLR) digital camera with interchangeable lenses. This manual has been written to help you enjoy taking pictures with your Nikon digital camera. Read this manual thoroughly before use, and keep it handy when using the product.





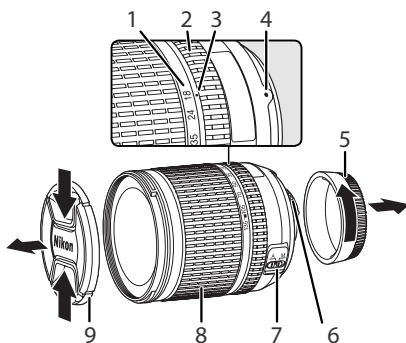

To make it easier to find the information you need, the following symbols and conventions are used:

	This icon marks cautions, information that should be read before use to prevent damage to the camera.		This icon marks tips, additional information that may be helpful when using the camera.
	This icon marks notes, information that should be read before using the camera.		This icon indicates that more information is available elsewhere in this manual or in the <i>Quick Start Guide</i> .
	This icon marks settings that can be adjusted using camera menus.		This icon marks settings that can be fine-tuned from the Custom Settings menu.

Lens

An AF-S DX 18–135 mm f/3.5–5.6G ED Zoom-Nikkor lens ( 145) is used in this manual for illustrative purposes.



- | | | |
|-----------------------|---|--|
| 1. Focal length scale | 4. Mounting index:  11 | 7. A-M mode switch:  11, 32 |
| 2. Focus ring | 5. Rear cap:  11 | 8. Zoom ring:  21 |
| 3. Focal length index | 6. CPU contacts:  117 | 9. Lens cap:  17, 19 |

Getting to Know the Camera

Take a few moments to familiarize yourself with camera controls and displays. You may find it helpful to bookmark this section and refer to it as you read through the rest of the manual.

Camera Body

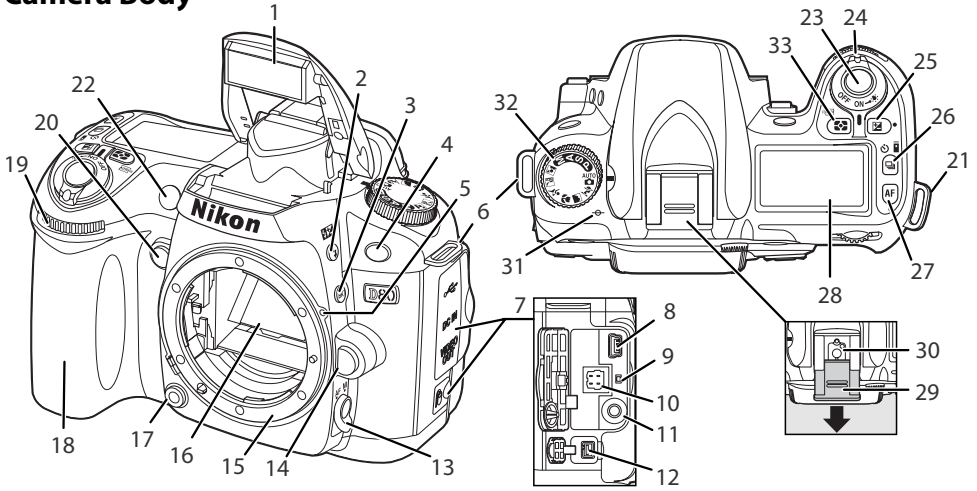

1 Built-in flash	23, 40	21 Eyelet for camera strap	8
2 (flash mode) button	40	22 AF-assist illuminator	28, 87
3 (flash compensation)	55	Self-timer lamp	37, 38
4 (bracketing) button	56–57	Red-eye reduction lamp	39
5 Infrared receiver	38	23 Shutter-release button	22, 23
6 Lens mounting index	11	24 Power switch	11, 19
7 Eyelet for camera strap	8	Illuminator switch	3
8 Connector cover	66, 67, 70	25 (exposure compensation) button	54
9 USB connector	67	(reset button)	44
10 Reset switch	129	26 (shooting mode) button	36
11 DC-IN connector for optional EH-5/EH-5a AC adapter	123	Single/continuous mode	36
12 Video connector	66	Self-timer mode	37
13 Remote cord connector	123	Remote control mode	38
14 Focus-mode selector	28, 32	27 (AF mode) button	29
15 Lens release button	11	(reset button)	44
16 Lens mount	11	28 Control panel	5
17 Mirror	106, 125	29 Accessory shoe cover	119
18 Depth-of-field preview button	49	30 Accessory shoe (for optional flash unit)	119
19 Grip	21	31 (focal plane mark)	32
20 Sub-command dial	10, 91	32 Mode dial	47, 48, 49, 50
21 FUNC. button	92	33 (metering mode) button	52
		(format) button	16

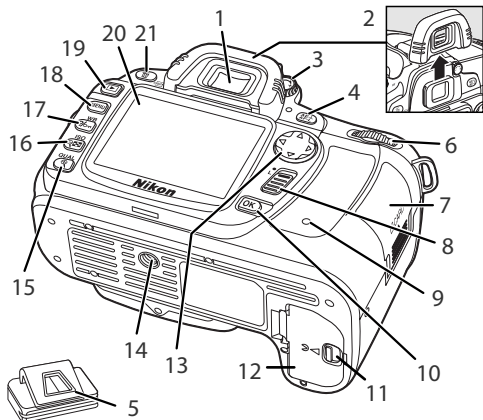

- 1 Viewfinder eyepiece..... 8
- 2 Viewfinder eyepiece cup..... 6, 17, 21
- 3 Diopter adjustment control..... 17
- 4 **AE-L/AF-L** (AE-L/AF-L) button..... 31, 94
- 5 DK-5 viewfinder eyepiece cap..... 8
- 6 Main command dial..... 10, 91

- 7 Memory card slot cover..... 15
- 8 Focus selector lock..... 30
- 9 Memory card access lamp..... 15, 23
- 10 **OK** button..... 9
- 11 Battery-chamber cover latch..... 13
- 12 Battery-chamber cover..... 13
- 13 Multi selector*
- 14 Tripod socket
- 15 **Q** (playback zoom) button..... 64
- QUAL** (image quality/size) button..... 34, 35
- 16 **z** (thumbnail) button..... 63
- ISO** (ISO sensitivity) button..... 43
- 17 **?** (help/protect) button..... 9, 65
- WB** (white balance) button..... 58
- 18 **MENU** (menu) button..... 9
- 19 **z** (playback) button..... 26, 61
- 20 Monitor..... 9, 26
- 21 **DEL** (delete) button..... 26, 65
- FORMAT** (format) button..... 16

* Multi selector

The multi selector is used for menu navigation and to control the display of photo information during playback.

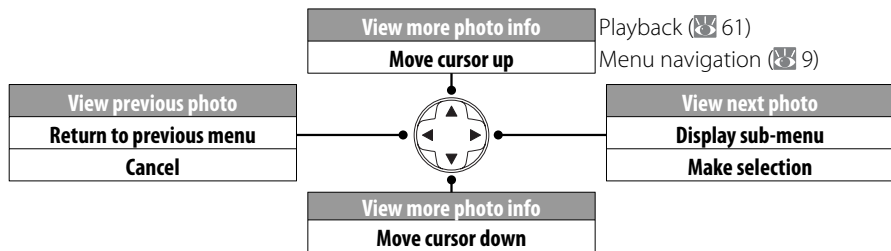

Help

For help on the current mode or menu item, press the **?** button at the bottom left corner of the monitor. Help is displayed while the **?** button is pressed; to scroll the display, press the multi selector up or down. Help is available in **AUTO** (auto) and Digital Vari-Program modes or when a **?** icon is displayed in the bottom left corner of the monitor.

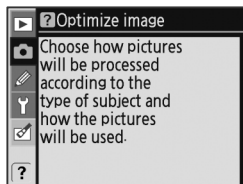

The LCD Illuminator

Holding the power switch in the **ON** position activates the exposure meters and the control panel back-light (LCD illuminator), allowing the display to be read in the dark. After the power switch is released, the illuminator will remain active while the exposure meters are active or until the shutter is released.

The Mode Dial

The D80 offers a choice of the following eleven shooting modes:



Advanced Modes (Exposure Modes)

Select these modes for full control over camera settings.

P — Programmed auto (47): Camera chooses shutter speed and aperture, user controls other settings.

S — Shutter-priority auto (48): Choose fast shutter speeds to freeze action, slow shutter speeds to suggest motion by blurring moving objects.

A — Aperture-priority auto (49): Adjust aperture to soften background details or increase depth-of-field to bring both main subject and background into focus.

M — Manual (50): Match shutter speed and aperture to your creative intent.

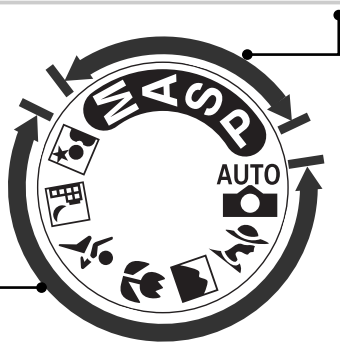

Point-and-Shoot Modes (Digital Vari-Programs)

Selecting a Digital Vari-Program automatically optimizes settings to suit the selected scene, making creative photography as simple as rotating the mode dial.

AUTO — Auto (19): Camera adjusts settings automatically to produce optimal results with “point-and-shoot” simplicity. Recommended for first-time users of digital cameras.

Portrait (24, 25): Shoot portraits with background in soft focus.

Landscape (24, 25): Preserve details in landscape shots.

Close up (24, 25): Take vivid close-ups of flowers, insects, and other small objects.

Sports (24, 25): Freeze motion for dynamic sports shots.

Night landscape (24, 25): Take landscape shots at night.

Night portrait (24, 25): Shoot portraits against a dimly-lit backdrop.

Control Panel

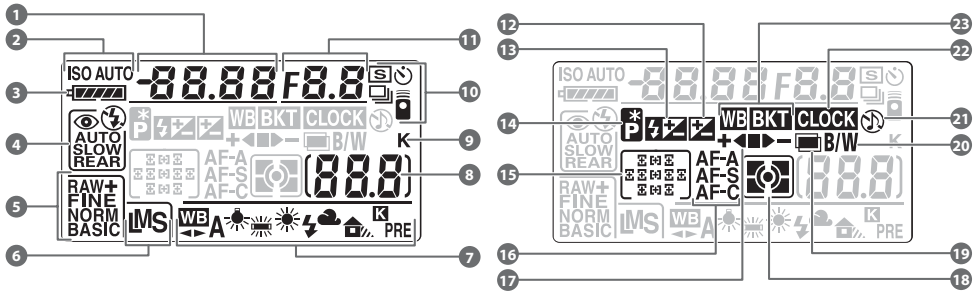

1	Shutter speed	48, 50	9	"K" (appears when memory remains for over 1000 exposures)	
	Exposure compensation value	54	10	Shooting mode	36
	Flash compensation value.....	55		Self-timer/remote control mode.....	37, 38
	ISO sensitivity.....	43	11	Aperture (f-number).....	49, 50
	White balance fine-tuning, or color temperature.....	58, 59		Bracketing increment	56
	Number of shots in bracketing sequence	56, 140		PC connection indicator.....	68
2	ISO sensitivity indicator	43	12	Exposure compensation indicator	54
	ISO AUTO indicator	43	13	Flash compensation indicator.....	55
3	Battery indicator	19	14	Flexible program indicator	47
4	Flash sync mode	40, 41	15	Focus area.....	30, 87
5	Image quality.....	34		AF-area mode	30, 87
6	Image size	35	16	AF mode	29
7	White balance mode	58	17	Bracketing progress indicator.....	56
8	Number of exposures remaining	19	18	Metering mode	52
	Number of shots remaining before memory buffer fills.....	36	19	Multiple exposure indicator	84
	PC mode indicator.....	68	20	Black-and-white indicator.....	81
	Preset white balance recording indicator... 60		21	"Beep" indicator	86
			22	"Clock not set" indicator.....	103, 132
			23	Bracketing indicator	56

Large-Capacity Memory Cards

When enough memory remains on the memory card to record a thousand or more pictures at current settings, the number of exposures remaining will be shown in thousands, rounded down to the nearest hundred (e.g., if there is room for approximately 1,260 exposures, the exposure count display will show 1.2K).

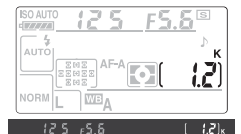

The Viewfinder Display

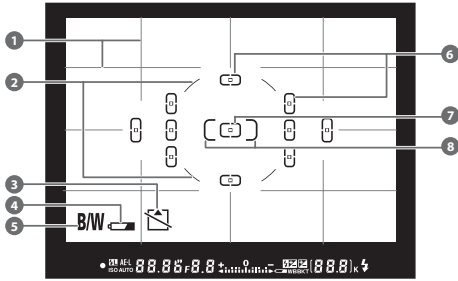

- 1 Framing grid (displayed when **On** is selected for Custom Setting 8 (**Grid display**)) 89
- 2 8-mm (0.31 in.) reference circle for center-weighted metering..... 52, 90
- 3 "No memory card" warning ¹ 15, 133
- 4 Battery indicator ¹ 19
- 5 Black-and-white indicator ¹..... 81
- 6 Focus brackets (focus area) 19, 21, 30
- 7 Normal-frame focus brackets (focus area) 21, 87
- 8 Wide-frame focus brackets (focus area)..... 87
- 9 Focus indicator 22
- 10 Flash value (FV) lock 94
- 11 Autoexposure (AE) lock 94
- 12 Shutter speed 48, 50
- 13 Aperture (f-number) 48, 50

If the battery is totally exhausted or not inserted, the display in the viewfinder will dim. The viewfinder display will return to normal when a fully-charged battery is inserted.

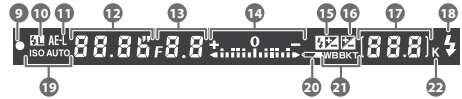

- 14 Electronic analog exposure display 50
- Exposure compensation 54
- 15 Flash compensation indicator 55
- 16 Exposure compensation indicator 54
- 17 Number of exposures remaining 19
- Number of shots remaining before memory buffer fills 36
- Preset white balance recording indicator... 60
- Exposure compensation value 54
- Flash compensation value 55
- PC connection indicator 68
- 18 Flash-ready indicator 23
- 19 Auto ISO sensitivity indicator 43
- 20 Battery indicator 19
- 21 Bracketing indicator 56
- 22 "K" (appears when memory remains for over 1000 exposures) 5

1. Can be hidden with Custom Setting 9 (K) 89)

The Control Panel and Viewfinder

The response times and brightness of the control panel and viewfinder may vary with temperature. Owing to the characteristics of this type of display, you may notice fine lines radiating outward from the selected focus area. This is normal and does not indicate a malfunction.

Supplied Accessories

The MH-18a Quick Charger (12)

The MH-18a is for use with the supplied EN-EL3e battery.

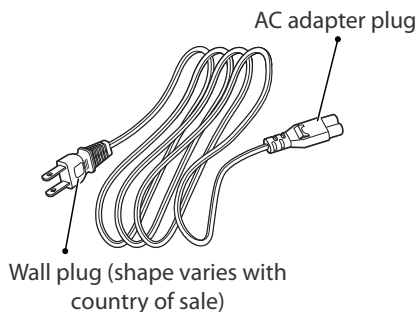
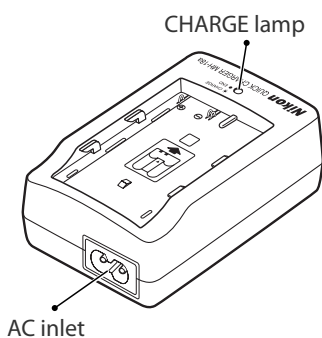

The EN-EL3e Rechargeable Li-ion Battery (12, 13)

The EN-EL3e is for use with the D80.

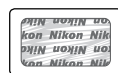
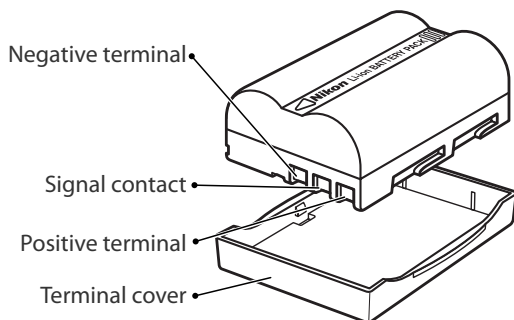

The use of third-party rechargeable Li-ion batteries not bearing the Nikon holographic seal shown above could interfere with normal operation of the camera or result in the batteries overheating, igniting, rupturing, or leaking.

Use Only Nikon Brand Electronic Accessories

Nikon cameras are designed to the highest standards and include complex electronic circuitry. Only Nikon brand electronic accessories (including lenses, Speedlights, battery chargers, batteries, and AC adapters) certified by Nikon specifically for use with this Nikon digital camera are engineered and proven to operate within the operational and safety requirements of this electronic circuitry.

THE USE OF NON-NIKON ELECTRONIC ACCESSORIES COULD DAMAGE THE CAMERA AND MAY VOID YOUR NIKON WARRANTY.

For more information about Nikon brand accessories, contact an authorized Nikon dealer.

The Camera Strap

Attach the camera strap as shown below.

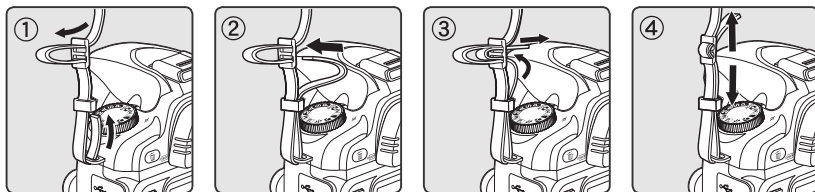

The BM-7 LCD Monitor Cover

A clear plastic cover is provided with the camera to keep the monitor clean and protect it when the camera is not in use. To attach the cover, insert the projection on the top of the cover into the matching indentation above the camera monitor (①) and press the bottom of the cover until it clicks into place (②).

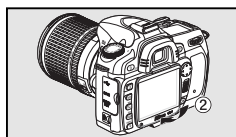
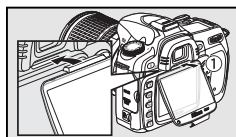

To remove the cover, hold the camera firmly and pull the bottom of the cover gently until outwards as shown at right.

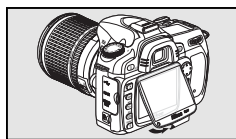

The DK-21 Viewfinder Eyepiece Cup

Before attaching the DK-5 viewfinder eyepiece cap and other viewfinder accessories (☒ 122), remove the viewfinder eyepiece cup by placing your fingers underneath the flanges at either side and sliding it off as shown at right.

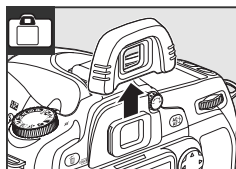

Using Camera Menus

Most shooting, playback, and setup options can be accessed from the camera menus. To view the menus, press the **MENU** button.

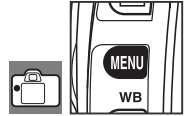

Choose from playback, shooting, Custom Settings, setup, and retouch menus (see below)

If "?" icon is displayed, help for the current item can be viewed by pressing the **INFO** button

Slider shows position in current menu

Current setting for each option is shown by icon

Current menu item is highlighted

Menu	Description
Playback	Adjust playback settings and manage photos (74).
Shooting	Adjust shooting settings (79).
Custom Settings	Personalize camera settings (86).
Setup	Format memory cards and perform basic camera setup (101).
Retouch	Create retouched copies of existing photographs (109).



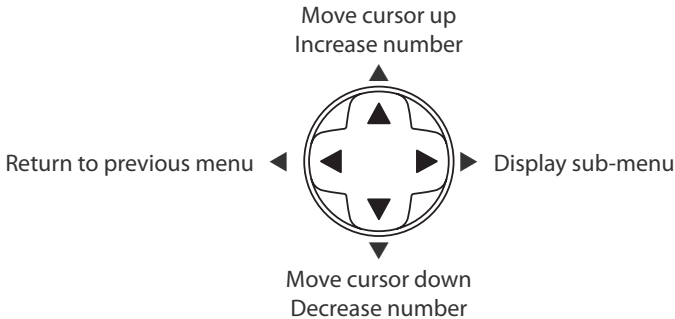





The multi selector and **OK** button are used to navigate the camera menus.



Press **OK** to select highlighted option.



To modify menu settings:

<p>1</p>  <p>Display menus.</p>	<p>2</p>  <p>Highlight icon for current menu.</p>
<p>3</p>  <p>Select menu.</p>	
<p>4</p>  <p>Position cursor in selected menu.</p>	<p>5</p>  <p>Highlight menu item.</p>
<p>6</p>  <p>Display options.</p>	<p>7</p>  <p>Highlight option.</p>
<p>8</p>  <p>Make selection.</p>	<p>Menu items that are displayed in gray are not currently available.</p>

Press the shutter-release button halfway to exit the menus and return to shooting mode (19, 28). The monitor will turn off.

Using the Command Dials

The main command dial can be used to move the cursor up and down, the sub-command dial to move the cursor left and right. The sub-command dial can not be used to make a selection.

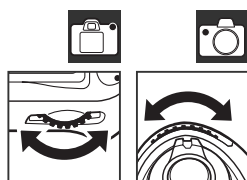

First Steps

Attaching a Lens

Care should be taken to prevent dust from entering the camera when the lens is removed.

1 Turn the camera off.

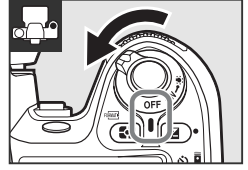

2 Remove the rear cap from the lens.

Remove the camera body cap.

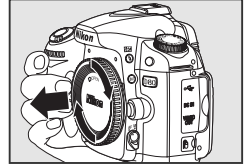
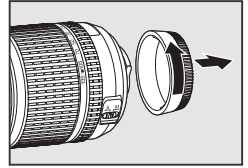

3 Keeping the mounting index on the lens aligned with the mounting index on the camera body, position the lens in the camera's bayonet mount and rotate the lens in the direction shown until it clicks into place.

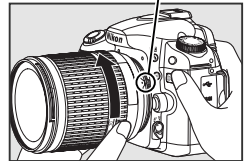

If the lens is equipped with an A-M or M/A-M switch, select A (autofocus) or M/A (autofocus with manual priority).



Detaching Lenses

Be sure the camera is off when removing or exchanging lenses. To remove the lens, press and hold the lens-release button while turning the lens clockwise. After removing the lens, replace the camera body cap and rear lens cover.

Aperture Ring

If the lens is equipped with an aperture ring ( 45, 117), lock aperture at the minimum setting (highest f-number). See the lens manual for details.

Charging and Inserting the Battery

The supplied EN-EL3e battery is not charged at shipment. Charge the battery using the supplied MH-18a battery charger as described below.

1 Charge the battery.

1.1 Remove the terminal cover from the battery.

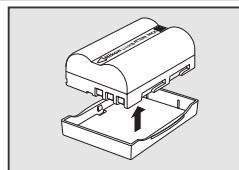

1.2 Connect the power cord to the charger and plug it in.

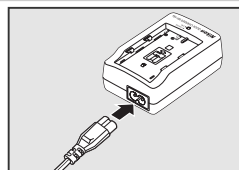

1.3 Place the battery in the charger. The CHARGE lamp will blink as the battery charges. About two and a quarter hours are required for an exhausted battery to fully charge.

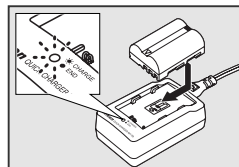

1.4 Charging is complete when the CHARGE lamp stops blinking. Remove the battery from the charger and unplug the charger.

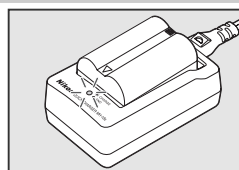

EN-EL3e Rechargeable Li-ion Batteries

The EN-EL3e shares information with compatible devices. The camera uses this information to display the battery charge state in six levels in the control panel and to show the battery charge state, remaining battery life, and number of pictures taken since the battery was last charged in the setup menu **Battery Info** display (107).

2 Insert the battery.

2.1 After confirming that the camera is off, open the battery chamber cover.

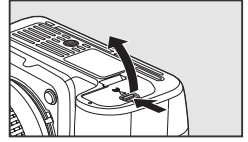

2.2 Insert a fully charged battery as shown at right. Close the battery chamber cover.

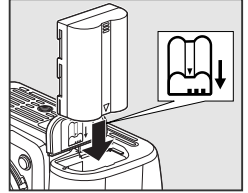

The Battery and Charger

Read and follow the warnings and cautions on pages ii–iii and 127–128 of this manual, together with any warnings and instructions provided by the battery manufacturer. Use only EN-EL3e batteries. The D80 is not compatible with the MS-D70 CR2 battery holder or with EN-EL3 or EN-EL3a batteries for D100, D70-series, or D50 cameras.







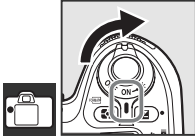

Do not use the battery at ambient temperatures below 0°C (32°F) or above 40°C (104°F). During charging, the temperature should be in the vicinity of 5–35 °C (41–95 °F). For best results, charge the battery at temperatures above 20°C (68°F). Battery capacity may drop if the battery is used at a temperature below the temperature at which it was charged. If the battery is charged at a temperature below 5°C (41°F), the battery life indicator in the **Battery Info** display may show a temporary decrease.

Removing the Battery

Turn the camera off before removing the battery. To avoid shorting the battery, replace the terminal cover when the battery is not in use.

Basic Setup

The first time the camera is turned on, the language selection dialog shown in Step 1 will be displayed in the monitor. Follow the steps below to choose a language and set the time and date.

<p>1</p>  <p>Turn camera on.</p>	<p>2</p>  <p>Select language.</p>
<p>3</p>  <p>Display map of world time zones.</p>	<p>4</p>  <p>Select local time zone.</p>
<p>5</p>  <p>Display daylight saving time options.</p>	<p>6</p>  <p>Highlight On if daylight saving time is in effect.</p>
<p>7</p>  <p>Display date menu.</p>	<p>8</p>  <p>Press multi selector left or right to select item, up or down to change.</p>
<p>9</p>  <p>Set clock and return to shooting mode. Monitor will turn off automatically.</p>	<p>To change the order in which the year, month, and day are displayed, select World time > Date format from the setup menu (103).</p>

Using Camera Menus

The language menu is only displayed automatically the first time menus are displayed. See "Using Camera Menus" (9–10) for information on normal menu operation.

Inserting Memory Cards

The camera stores pictures on Secure Digital (SD) memory cards (available separately).

1 Insert a memory card.

- 1.1** Before inserting or removing memory cards, turn the camera off and open the card slot cover.

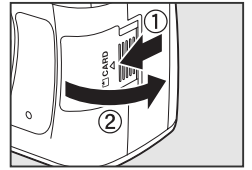

- 1.2** Slide the memory card in as shown at right until it clicks into place. The memory card access lamp will light for about a second. Close the memory card slot cover.

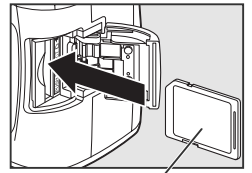

Front

- 1.3** Turn the camera on. If the control panel shows the number of exposures remaining, the card is ready for use.

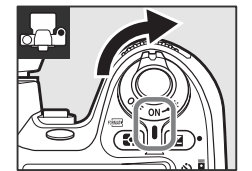

If the message shown at right is displayed in the monitor, format the card as described in “Camera Error Messages and Displays” (p. 133).

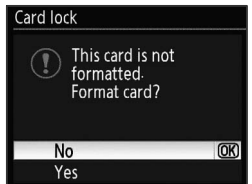

✓ The Access Lamp

Do not remove the battery or disconnect the power source while the memory card access lamp is lit. Failure to observe this precaution could result in damage to the card.

🔒 The Write Protect Switch

SD cards are equipped with a write protect switch to prevent accidental loss of data. When this switch is in the “lock” position, the camera will display a message to warn that photos can not be recorded or deleted and the memory card can not be formatted.

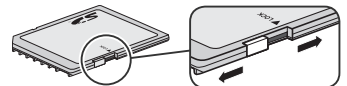

2 Memory cards must be formatted the first time they are used in the D80. To format the memory card, turn the camera on and press the **FORMAT** (🗑️) and (🔄) buttons until control panel and viewfinder displays flash as shown at right. Pressing both buttons together a second time will format the memory card. During formatting, the letters **F o r** will appear in the frame-count display. Do not turn the camera off or remove the battery until formatting is complete, the monitor has turned off, and the control panel shows the number of exposures remaining.

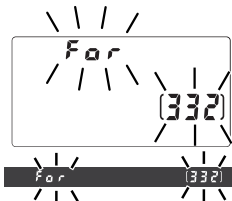
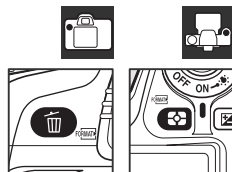

✓ Formatting Memory Cards

Format cards in the camera. Performance may drop if they are formatted in a computer.

Formatting memory cards permanently deletes all photographs and other data they may contain. Be sure all data you wish to keep have been copied to another storage device before formatting the card.

✂ Removing Memory Cards

1. Confirm that the access lamp is off.
2. Turn the camera off and open the memory card slot cover.
3. Press the card in to eject (①). The card can then be removed by hand (②).

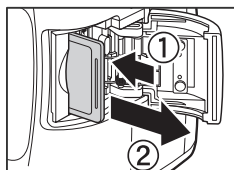
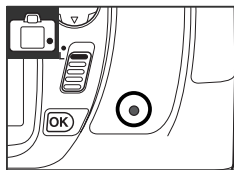

📷 Camera Off Display

If the camera is turned off with a battery and memory card inserted, the number of exposures remaining will be displayed in the control panel. If no memory card is inserted, the control panel will show **-E-** and a 📷 icon will be displayed in the viewfinder.

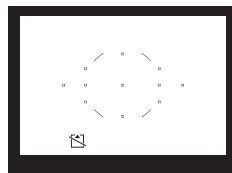
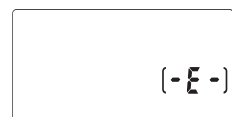

Adjusting Viewfinder Focus

Photographs are framed in the viewfinder. Before shooting, make sure that the display in the viewfinder is in clear focus.

Viewfinder Focus

Viewfinder focus (diopter) can be adjusted in the range -2 – $+1$ m⁻¹. Corrective lenses (available separately;  122) allow diopters of -5 – $+3$ m⁻¹.

- 1 Remove the lens cap and turn the camera on.

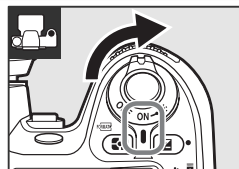

- 2 Rotate the diopter adjustment control until the focus brackets are in sharp focus. When operating the diopter adjustment control with your eye to the viewfinder, be careful not to put your fingers or fingernails in your eye.

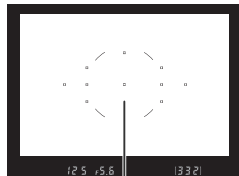
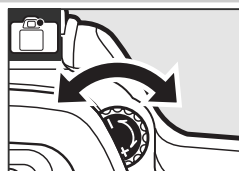

Focus brackets

Tutorial

Photography and Playback

The Tutorial outlines the basics of taking and viewing photographs in  (auto) and Digital Vari-Program modes. This section assumes that default camera settings are used; for information on restoring default settings, see page 134.

Use a CPU Lens

 (auto) and Digital Vari-Program modes are only available with CPU lenses. If these modes are selected when a non-CPU lens is attached, the shutter release will be disabled.

Auto Meter Off

At default settings, the viewfinder display and the aperture and shutter-speed indicators in the control panel will turn off if no operations are performed for about six seconds (auto meter off), reducing the drain on the battery. Press the shutter-release button halfway to reactivate the display.

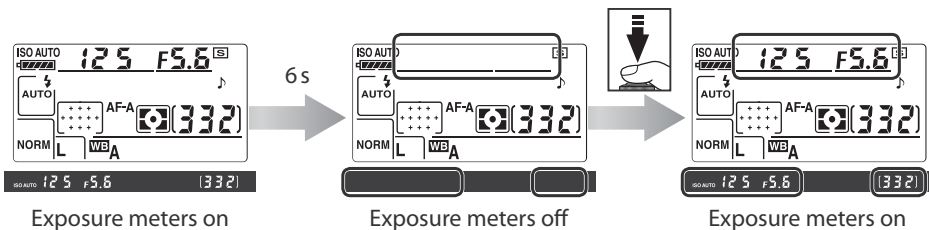

The length of time before the exposure meters turn off automatically can be adjusted using Custom Setting 28 (**Auto meter off**;  99).

“Point-and-Shoot” Photography (AUTO Mode)

This section describes how to take photographs in **AUTO** (auto) mode, an automatic “point-and-shoot” mode in which the majority of settings are controlled by the camera in response to shooting conditions.

1 Turn the camera on.

- 1.1** Remove the lens cap and turn the camera on. The control panel and viewfinder displays will light. The monitor remains off during shooting.

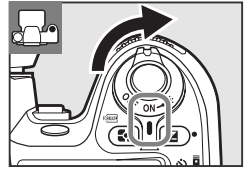

- 1.2** Check the battery level in the viewfinder or control panel.

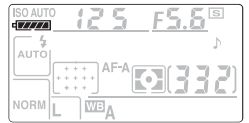

Control panel	Viewfinder	Description
	—	Battery fully charged.
	—	Battery partially discharged.
	—	
	—	
		Low battery. Ready fully-charged spare battery.
		Shutter release disabled. Change battery.

Battery level not displayed when camera is powered by optional AC adapter.

- 1.3** The exposure count displays in the control panel and viewfinder show the number of photographs that can be stored on the memory card. Check the number of exposures remaining.

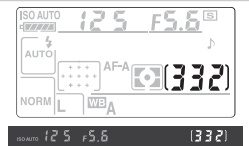

If there is not enough memory to store additional photographs at current settings, the display will flash as shown at right. No further pictures can be taken until the memory card has been replaced (15) or photographs have been deleted (26, 65, 74).

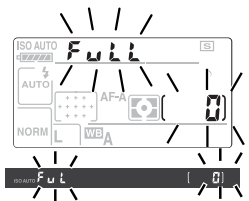

2 Select **AUTO** mode and choose autofocus.

2.1 Rotate the mode dial to **AUTO**.

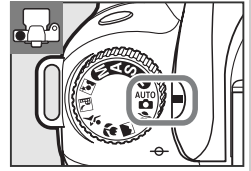

2.2 Rotate the focus-mode selector to AF (autofocus).

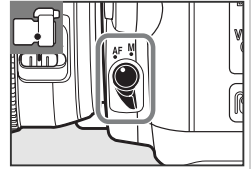

3 Check settings in the control panel. The default settings for **AUTO** mode are listed below.

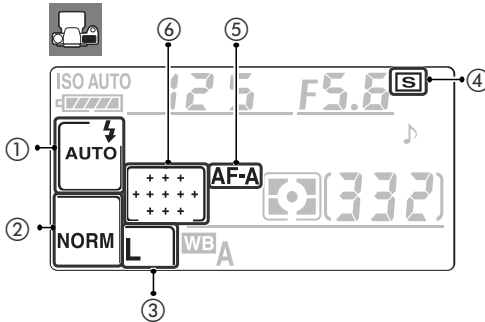

Option	Default	
① Flash sync mode	Auto	40
② Image quality	JPEG Normal	34
③ Image size	Large	35
④ Shooting mode	Single frame	36
⑤ Autofocus mode	Auto select	29
⑥ AF-area mode	Auto-area AF	30

4 Frame a photograph in the viewfinder. The monitor remains off during shooting.

4.1 Hold the camera as shown.



Holding the Camera

Hold the handgrip in your right hand and cradle the camera body or lens with your left. Keep your elbows propped lightly against your torso for support and place one foot half a pace ahead of the other to keep your upper body stable.



4.2 Frame a photo in the viewfinder with the main subject positioned in any of the eleven focus areas.

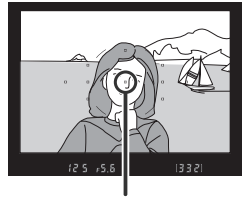

Focus area



Using a Zoom Lens

Use the zoom ring to zoom in on the subject so that it fills a larger area of the frame, or zoom out to increase the area visible in the final photograph (select longer focal lengths on the lens focal length scale index to zoom in, shorter focal lengths to zoom out).

Zoom in

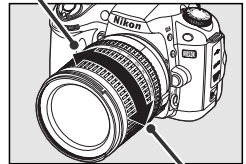

Zoom out

5 Focus.

5.1 Press the shutter-release button halfway to focus. The camera will select the focus area automatically. If the subject is dark, the flash may pop up and the AF-assist illuminator may light.



5.2 When the focus operation is complete, the selected focus areas will be briefly highlighted, a beep will sound, and the in-focus indicator (●) will appear in the viewfinder (the beep may not sound if the subject is moving). While the shutter-release button is pressed halfway, focus will lock and the number of exposures that can be stored in the memory buffer will be displayed in the viewfinder.

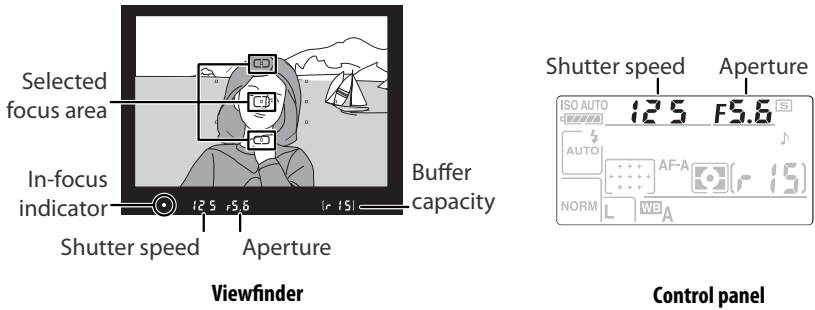

In-focus indicator	Description
●	Subject in focus.
● (blinks)	Camera unable to focus on subject in focus area using autofocus.

The Shutter-Release Button

The camera has a two-stage shutter-release button. The camera focuses when the shutter-release button is pressed halfway. To take the photograph, press the shutter-release button the rest of the way down.

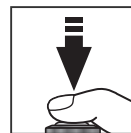

Focus

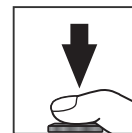

Take photograph

6 Take the photograph.

Smoothly press the shutter-release button the rest of the way down to release the shutter and record the photograph. The access lamp next to the memory card slot cover will light. *Do not eject the memory card or remove or disconnect the power source until the lamp has gone out and recording is complete.*





7 Turn the camera off when shooting is complete.

Camera Off Display

If the camera is turned off with a battery and memory card inserted, the number of exposures remaining will be displayed in the control panel.



The Built-in Flash

If additional lighting is required for correct exposure in **AUTO** mode, the built-in flash will pop up automatically when the shutter-release button is pressed halfway. Flash range varies with aperture and ISO sensitivity ( 141); remove lens hoods when using the flash. If the flash is raised, photographs can only be taken when the flash-ready indicator () is displayed. If the flash-ready indicator is not displayed, remove your finger briefly from the shutter-release button and try again.

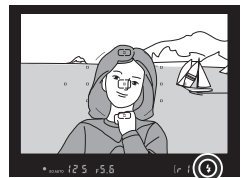
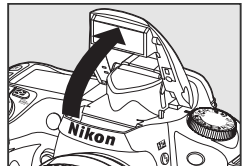



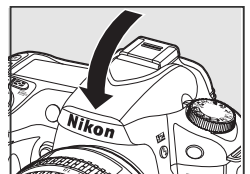



To save battery power when the flash is not in use, return it to its closed position by pressing it gently downward till the latch clicks into place. For more information on using the flash, see page 40.



Creative Photography (Digital Vari-Programs)

In addition to **AUTO**, the D80 offers a choice of six Digital Vari-Program modes. Selecting a program automatically optimizes settings to suit the selected scene, making creative photography as easy as rotating the mode dial.

Mode	Description
 Portrait	For portraits.
 Landscape	For natural and man-made landscapes.
 Close up	For close up shots of flowers, insects, and other small objects.
 Sports	For moving subjects.
 Night landscape	For low-light or night scenes.
 Night portrait	For portraits taken under low light.

To take photographs in Digital Vari-Program modes:



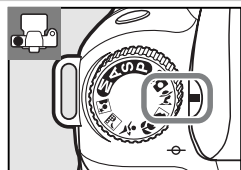





- 1 Rotate the mode dial to select a Digital Vari-Program mode.





- 2 Frame a photograph, focus, and shoot.

Focus Area

At default settings, the camera selects the focus area as follows:

- , , , and  modes: The camera selects the focus area automatically.
-  mode: The camera focuses on the subject in the center focus area. Other focus areas can be selected with the multi selector ( 30).
-  mode: The camera focuses continuously while the shutter-release button is pressed halfway, tracking the subject in the center focus area. If the subject leaves the center focus area, the camera will continue to focus based on information from the other focus areas. The starting focus area can be selected with the multi selector ( 30).

The Built-in Flash

If additional lighting is required for correct exposure in , , or  mode, the built-in flash will pop automatically when the shutter-release button is pressed halfway.

Portrait

Use for portraits with soft, natural-looking skin tones. If the subject is far from the background or a telephoto lens is used, background details will be softened to lend the composition a sense of depth.



Landscape

Use for vivid landscape shots. The built-in flash and AF-assist illuminator turn off automatically.



Close Up

Use for close-up shots of flowers, insects, and other small objects. The camera automatically focuses on the subject in the center focus area. Use of a tripod is recommended to prevent blur.



Sports

High shutter speeds freeze motion for dynamic sports shots in which the main subject stands out clearly. The built-in flash and AF-assist illuminator turn off automatically.



Night Landscape

Slow shutter speeds are used to produce stunning night landscapes. The built-in flash and AF-assist illuminator turn off automatically; use of a tripod is recommended to prevent blur.



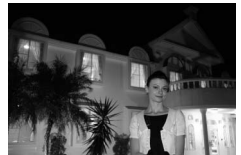

Night Portrait

Use for a natural balance between the main subject and the background in portraits taken under low light.



Basic Playback

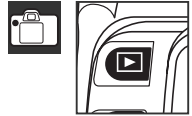

Photographs are automatically displayed for about four seconds after shooting. If no photograph is displayed in the monitor, the most recent picture can be viewed by pressing the  button. Additional pictures can be displayed by rotating the main command dial or pressing the multi selector left or right. Press the multi selector up or down to view highlights or additional shooting information about the current photograph ( 62–63).

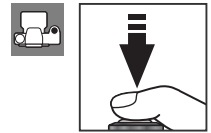

To end playback and return to shooting mode, press the shutter-release button halfway.



Deleting Unwanted Photographs

To delete the photograph currently displayed in the monitor, press the  button. A confirmation dialog will be displayed. Press the  button again to delete the image and return to playback. To exit without deleting the picture, press the  button.

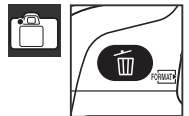

Reference

This section builds on the Tutorial to cover more advanced shooting and playback options.

More on Photography (All Modes): 📷 28

Shoot a moving subject or focus manually	Focus: 📷 28
Adjust image quality and size	Image Quality and Size: 📷 33
Take photographs in one at a time, in bursts, or using the self-timer or a remote control	Choosing a Shooting Mode: 📷 36
Use the built-in flash	Using the Built-in Flash: 📷 40
Raise ISO sensitivity when lighting is poor	ISO Sensitivity: 📷 43
Restore default settings	Two-Button Reset: 📷 44

P, S, A, and M Modes: 📷 45

Let the camera choose shutter speed and aperture	Mode P (Programmed Auto): 📷 47
Freeze or blur motion	Mode S (Shutter-Priority Auto): 📷 48
Choose whether to blur background objects	Mode A (Aperture-Priority Auto): 📷 49
Choose shutter speed and aperture manually	Mode M (Manual): 📷 50
Choose a metering method, lock exposure, adjust exposure and flash level	Exposure: 📷 52
Make colors look natural Take photos under unusual lighting	White Balance: 📷 58

See the Menu Guide for information on other operations that can only be performed in **P**, **S**, **A**, and **M** modes, including customizing sharpening, contrast, color saturation, and hue (“Optimize Image”; 📷 79) and creating multiple exposures (“Multiple Exposure”; 📷 84).

More on Playback: 📷 61

View photographs on the camera	Viewing Photographs on the Camera: 📷 61
--------------------------------	--

See the Menu Guide for other playback options (📷 74).

Connecting to a TV, Computer, or Printer: 📷 66

View photographs on TV	Viewing Photographs on TV: 📷 66
Copy photographs to a computer	Connecting to a Computer: 📷 67
Print photographs	Printing Photographs: 📷 69

More on Photography (All Modes)

Focus

Focus can be adjusted automatically (see “Autofocus,” below) or manually (📷 32). The user can also select the focus area for automatic or manual focus (📷 30) or use focus lock to focus and recompose photographs after focusing (📷 31).

Autofocus

Controls used: Focus mode selector

When the focus mode selector is set to **AF**, the camera focuses automatically when the shutter-release button is pressed halfway. In single-area AF, a beep will sound when the camera focuses. No beep will sound when **AF-A** is selected in 🏃 (sports) mode or when continuous-servo autofocus is used (note that continuous-servo autofocus may be selected automatically when shooting moving subjects in **AF-A** autofocus mode).

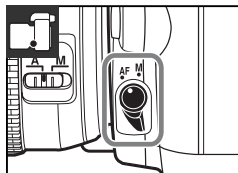

If the lens does not support autofocus or the camera is unable to focus using autofocus, use manual focus (📷 32).

📷 A-M Selection/Autofocus with Manual Priority

If the lens is equipped with A-M selection or an M/A-M switch, select **A** (autofocus) or **M/A** (autofocus with manual priority).



📷 The AF-Assist Illuminator

If the subject is poorly lit, the AF-assist illuminator will light automatically to assist the autofocus operation when the shutter-release button is pressed halfway. The AF-assist illuminator will not light in 🏠, 🏃, or 🏠 modes or if **Off** has been selected for Custom Setting 4 (**AF assist**, 📷 87). The illuminator has a range of about 0.5–3.0 m (1 ft. 8 in.–9 ft. 10 in.); when using the illuminator, use a lens with a focal length of 24–200 mm and remove the lens hood.

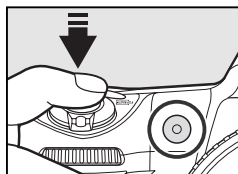

📷 1 — Beep (📷 86)

This option can be used to turn the beep speaker on or off.

Autofocus Mode

Controls used: **AF** button

The following autofocus modes are available when the focus mode selector is set to **AF**:

Autofocus mode	Description
AF-A Auto select (default setting)	Camera automatically selects single-servo autofocus when subject is stationary, continuous-servo autofocus when subject is moving. Shutter can only be released if camera is able to focus.
AF-S Single-servo AF	For stationary subjects. Focus locks when shutter-release button is pressed halfway. Shutter can only be released when in-focus indicator is displayed.
AF-C Continuous-servo AF	For moving subjects. Camera focuses continuously while shutter-release button is pressed halfway. Photographs can be taken even when in-focus indicator is not displayed.

To choose the autofocus mode, press the **AF** button until the desired setting is displayed.

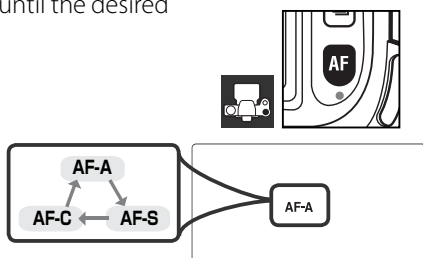

Getting Good Results with Autofocus

Autofocus does not perform well under the conditions listed below. The shutter release may be disabled if the camera is unable to focus under these conditions, or the in-focus indicator (●) may be displayed and the camera may sound a beep, allowing the shutter to be released even when the subject is not in focus. In these cases, use manual focus (32) or use focus lock (31) to focus on another subject at the same distance and then recompose the photograph.

There is little or no contrast between the subject and the background



Example: Subject is the same color as the background.

The focus area contains objects at different distances from the camera



Example: Subject is inside a cage.

The subject is dominated by regular geometric patterns



Example: A row of windows in a skyscraper.

The focus area contains areas of sharply contrasting brightness

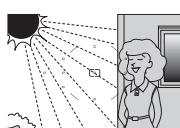

Example: Subject is half in the shade.

The subject appears smaller than the focus area



Example: Focus area contains both foreground subject and distant buildings.

The subject contains many fine details

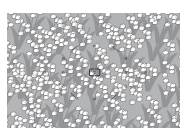







Example: A field of flowers or other subjects that are small or lack variation in brightness.

Focus Area Selection

Controls used: Multi selector (monitor off)

The D80 offers a choice of eleven focus areas that together cover a wide area of the frame. At the default settings, the camera chooses the focus area automatically or focuses on subject in the center focus area. The focus area can also be selected manually to compose photographs with the main subject positioned almost anywhere in the frame.

- 1 At default settings, the focus area is selected automatically in , , , , and  modes. To enable manual focus selection in these modes, select **Single Area** or **Dynamic Area** for Custom Setting 2 (**AF-Area Mode**;  87).

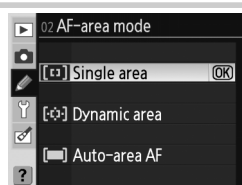





- 2 Slide the focus selector lock to the "●" position. This allows the multi selector to be used to select the focus area.

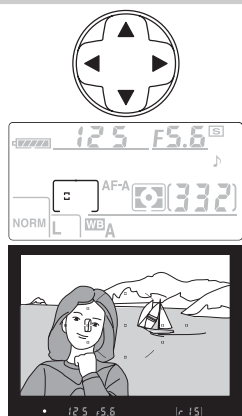

- 3 Use the multi selector to select the focus area in the viewfinder or control panel while the exposure meters are active ( 18). The focus selector lock can be returned to the "L" (locked) position following selection to prevent the selected focus area from changing when the multi selector is pressed.



Custom Settings

Custom Setting 2 (**AF-Area Mode**;  87) controls how the camera selects the focus area. Custom Setting 3 (**Center AF Area**;  87) controls the size and number of focus areas available. Custom Setting 18 (**AE-L/AF-L**;  94) determines whether the **AE-L/AF-L** button can be used to select the focus area. Custom Setting 20 (**Focus Area**;  94) controls whether focus area selection "wraps around." Custom Setting 21 (**AF Area Illumination**;  95) controls whether the active focus area is highlighted in the viewfinder.

Focus Lock

Controls used: AE-L/AF-L button (AF-A/AF-C)/Shutter-release button (AF-S)

Focus lock can be used to change the composition after focusing, making it possible to focus on a subject that will not be in a focus area in the final composition. It can also be used when the autofocus system is unable to focus (📷 29).

- 1 Position the subject in the selected focus area and press the shutter-release button halfway to initiate focus.



- 2 Check that the in-focus indicator (●) appears in the viewfinder.

AF-A and AF-C autofocus modes (📷 29)

Press the **AE-L/AF-L** button to lock both focus and exposure. Focus will remain locked while the **AE-L/AF-L** button is pressed, even if you later remove your finger from the shutter-release button.

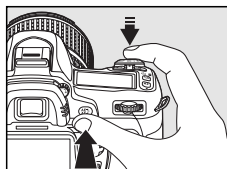

AF-S autofocus modes (📷 29)

Focus will lock automatically when the in-focus indicator appears, and remain locked until you remove your finger from the shutter-release button. Focus can also be locked by pressing the **AE-L/AF-L** button (see below).

An **AE-L** icon will be displayed in the viewfinder.

- 3 Recompose the photograph and shoot.



Focus will remain locked between shots as long as the shutter-release button is kept pressed halfway, allowing several photographs in succession to be taken at the same focus setting. Focus will also remain locked between shots while the **AE-L/AF-L** button is pressed.

Do not change the distance between the camera and the subject while focus lock is in effect. If the subject moves, focus again at the new distance.

Continuous Shooting Mode (📷 36)

Use the **AE-L/AF-L** button to lock focus in continuous shooting mode.

18 — AE-L/AF-L (📷 94)

This option controls the behavior of the **AE-L/AF-L** button.

Manual Focus

Controls used: Focus mode selector/lens focusing ring

Manual focus is available for lenses that do not support autofocus (non-AF Nikkor lenses) or when autofocus does not produce the desired results (📷 29). To focus manually, set the focus-mode selector to **M** and adjust the lens focusing ring until the image displayed on the clear matte field in the viewfinder is in focus. Photographs can be taken at any time, even when the image is not in focus.

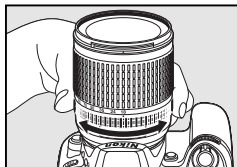
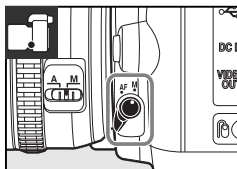

When using a lens that offers A-M selection, select M when focusing manually. With lenses that support M/A (autofocus with manual priority), focus can be adjusted manually with the lens set to M or M/A. See the documentation provided with your lens for details.

📷 The Electronic Rangefinder

If the lens has a maximum aperture of f/5.6 or faster, the viewfinder focus indicator can be used to confirm whether the portion of the subject in the selected focus area is in focus. After positioning the subject in the active focus area, press the shutter-release button halfway and rotate the lens focusing ring until the in-focus indicator (●) is displayed. Note that if the subject is one for which autofocus does not perform well (📷 29), the in-focus indicator may be displayed when the subject is not in focus. Confirm that the image in the viewfinder is in focus before shooting.

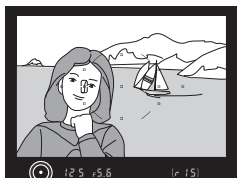

📷 Focal Plane Position

To determine the distance between your subject and the camera, measure from the focal plane mark on the camera body. The distance between the lens mounting flange (📷 11) and the focal plane is 46.5 mm (1.83 in.).

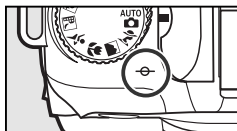
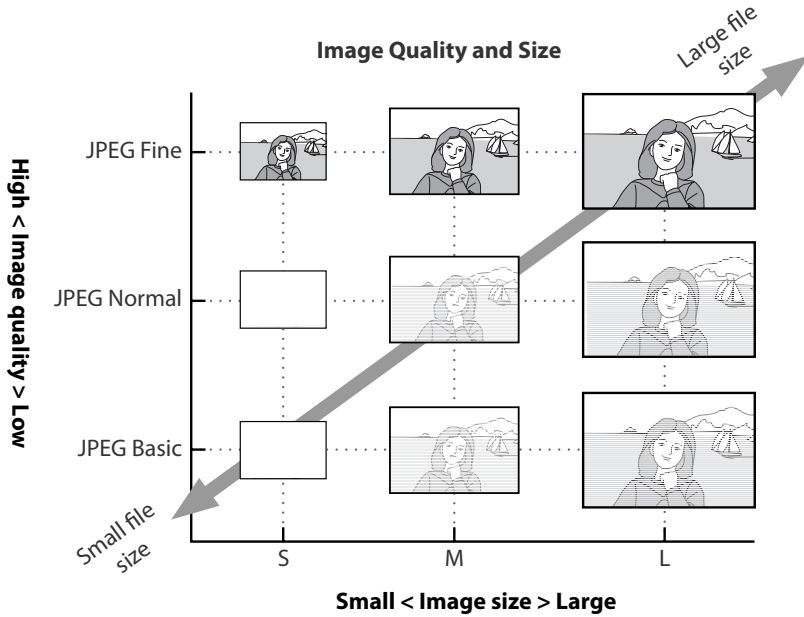

Image Quality and Size

Together, image quality and size determine how much space each photograph occupies on the memory card. Larger, higher quality images can be printed at larger sizes but also require more memory, meaning that fewer such images can be stored on the memory card.



Changes to image quality and size are reflected in the number of exposures remaining as displayed in the control panel and viewfinder (19).

Image Quality, Image Size, and File Size

See the Appendix for information on the number of pictures that can be stored on a memory card (138).

Image Quality

Controls used:  button + main command dial (monitor off)

The camera supports the following image quality options (listed in descending order by image quality and file size):

Option	Description
NEF (RAW)	Compressed raw data from the image sensor are saved directly to memory card. Choose for images that will be processed on a computer.
JPEG Fine	Images are compressed less than JPEG Normal , producing higher-quality images. Compression ratio: roughly 1 : 4.
JPEG Normal (default)	Best choice in most situations. Compression ratio: roughly 1 : 8.
JPEG Basic	Smaller file size suited to e-mail or the Web. Compression ratio: roughly 1 : 16.
NEF (RAW) + JPEG Fine	Two images are recorded: one NEF (RAW) image and one fine-quality JPEG image.
NEF (RAW) + JPEG Normal	Two images are recorded: one NEF (RAW) image and one normal-quality JPEG image.
NEF (RAW) + JPEG Basic	Two images are recorded: one NEF (RAW) image and one basic-quality JPEG image.

Image quality can be set by pressing the **QUAL** button and rotating the main command dial until the desired setting is displayed in the control panel. Image quality can also be adjusted from the shooting menu ( 81).

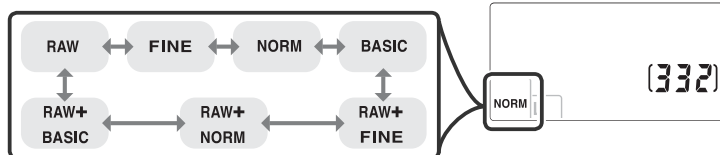
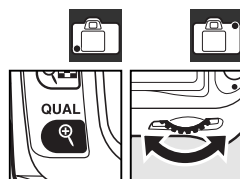

NEF (RAW)/NEF+JPEG

Capture NX (available separately;  123) or the supplied ViewNX software are required to view NEF (RAW) images on a computer. ViewNX can be installed from the supplied Software Suite CD-ROM. When photographs taken at **NEF (RAW) + JPEG Fine**, **NEF (RAW) + JPEG Normal**, or **NEF (RAW) + JPEG Basic** are viewed on the camera, only the JPEG image will be displayed. When photographs taken at these settings are deleted, both NEF and JPEG images will be deleted.

White balance bracketing ( 90) is not available when an NEF (RAW) + JPEG option is selected for image quality. Selecting an NEF (RAW) + JPEG option cancels white balance bracketing.

Image Size

Controls used:  button + sub-command dial (monitor off)

Image size is measured in pixels. The following options are available.

Image size	Size (pixels)	Approximate size when printed at 200 dpi*
Large (3872 × 2592/10.0 M) (default)	3,872 × 2,592	49.2 × 32.9 cm (19.36 × 12.96 in.)
Medium (2896 × 1944/5.6 M)	2,896 × 1,944	36.8 × 24.7 cm (14.48 × 9.72 in.)
Small (1936 × 1296/2.5 M)	1,936 × 1,296	24.6 × 16.5 cm (9.68 × 6.48 in.)

* “dpi” stands for **d**ots **p**er **i**nch, a measure of printer resolution. Images printed at higher resolutions will be smaller, images printed at lower resolutions larger.

Image size can be set by pressing the **QUAL** button and rotating the sub-command dial until the desired setting is displayed in the control panel. Image quality can also be adjusted from the shooting menu ( 81).

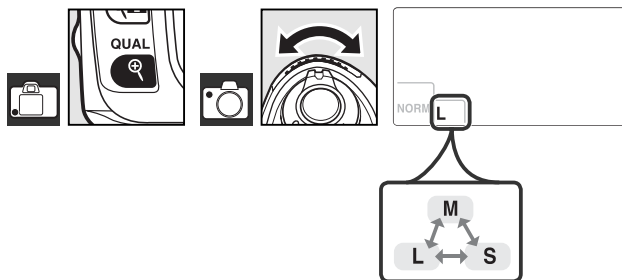

Note that the option selected for image size does not affect the size of NEF (RAW) images. When viewed on a computer, NEF images are 3,872 × 2,592 pixels in size.









File Names

Photographs are stored as image files with names of the form “DSC_nnnn.xxx,” where nnnn is a four-digit number between 0001 and 9999 assigned automatically in ascending order by the camera, and xxx is one of the following three letter extensions: “NEF” for NEF images or “JPG” for JPEG images. The NEF and JPEG files recorded at a setting of “NEF+JPEG” have the same file names but different extensions. Small copies created with the small picture option in the retouch menu have file names beginning with “SSC_” and ending with the extension “JPG” (e.g., “SSC_0001.JPG”), while images recorded with the other options in the retouch menu have file names beginning with “CSC” (e.g., “CSC_0001.JPG”). Images recorded at a **Optimize Image > Custom > Color Mode** setting of **II (AdobeRGB)** ( 80) have names that begin with an underscore (e.g., “_DSC0001.JPG”).

Choosing a Shooting Mode

Controls used:  button

Shooting mode determines how the camera takes photographs: one at a time, in a continuous sequence, with a timed shutter-release delay, or with a remote control.

Mode	Description
 Single frame	Camera takes one photograph each time shutter-release button is pressed. Access lamp will light while photo is recorded; next shot can be taken immediately if enough space remains in memory buffer.
 Continuous	Camera records photographs at up to three frames per second ¹ while shutter-release button is pressed.
 Self-timer	Use for self-portraits or to reduce blurring caused by camera shake ( 37).
 Delayed remote	Optional ML-L3 remote control required. Use for self-portraits ( 38).
 Quick-response remote	Optional ML-L3 remote control required. Use to reduce blurring caused by camera shake ( 38).

1. Average frame rate with manual focus, manual or shutter-priority auto exposure, a shutter speed of $1/250$ s or faster, and memory remaining in memory buffer.

To choose a shooting mode, press the  button until the desired setting is displayed.

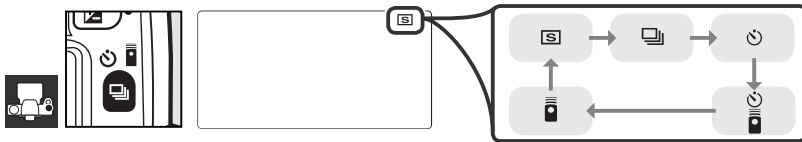

Buffer Size

The number of images that can be stored in the memory buffer at current settings is shown in the exposure-count displays in the viewfinder and control panel while the shutter-release button is pressed. This number is updated as photographs are transferred to the memory card and more memory becomes available in the buffer. If 0 is displayed, the buffer is full and shooting will slow. Shooting can continue up to a maximum of 100 shots. See the Appendix for more information ( 138).

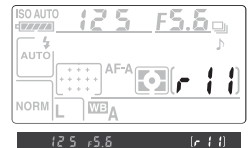

While photographs are being recorded to the memory card, the access lamp next to the memory card slot will light. *Do not remove the memory card or remove or disconnect the power source until the access lamp has gone out.* If the camera is switched off while data remain in the buffer, the power will not turn off until all images in the buffer have been recorded.





Self-Timer Mode (⌚)

The self-timer can be used to reduce camera shake or for self-portraits.

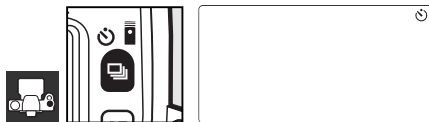
1 Mount the camera on a tripod or place the camera on a stable, level surface.

2 Press the  button until  is displayed in the control panel.



3 Frame the photograph. Before taking a photograph with the flash in **P**, **S**, **A**, or **M** modes ( 45), press the  button to raise the flash and wait for the  indicator to be displayed in the viewfinder ( 40). The timer will stop if the flash is raised after the timer has started.

4 In modes other than **M**, remove the viewfinder eyepiece cup and insert the supplied DK-5 eyepiece cap as shown. This prevents light entering via the viewfinder interfering with exposure.

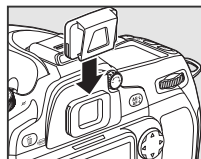

5 Press the shutter-release button halfway to focus, and then press the button the rest of the way down to start the self-timer. The self-timer lamp will start to blink and a beep will begin to sound. Two seconds before the photograph is taken, the self-timer lamp will stop blinking and the beeping will become more rapid. At default settings, the shutter will be released ten seconds after the timer starts.

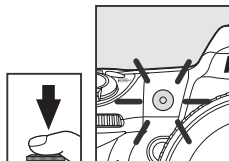

The timer will not start if the camera is unable to focus or in other situations in which the shutter can not be released.

The self-timer can be cancelled by selecting another shooting mode. Turning the camera off cancels self-timer mode and restores single frame or continuous shooting mode.

Bulb

In self-timer mode, a shutter speed of **b**  **L** **b** is equivalent to approximately 1/10s.

1 — Beep (86)

This option controls the beep that sounds during the self-timer count-down.

29 — Self-timer (99)

Self-timer delay can be set to 2s, 5s, 10s (the default setting), or 20s.

Using a Remote Control (📷)



Use the optional ML-L3 remote control for self-portraits (📷 123) or to operate the camera remotely.

🔧 Before Using the Remote Control

Before using the remote control for the first time, remove the clear plastic battery insulator sheet.

1 Mount the camera on a tripod or place the camera on a stable, level surface.

2 Press the  button to select one of the following modes:

Mode	
 Delayed remote	Shutter released about 2 s after remote shutter-release button is pressed.
 Quick-response remote	Shutter released when remote shutter-release button is pressed.



The camera will enter stand-by mode. At default settings, single frame or continuous shooting mode will be restored if no operations are performed for about a minute.

3 Frame the photograph. If autofocus is in effect, the camera shutter-release button can be used to set focus, although only the shutter-release button on the remote control can be used to release the shutter.

4 In modes other than **M**, remove the viewfinder eyepiece cup and insert the supplied DK-5 eyepiece cap as shown. This prevents light entering via the viewfinder interfering with exposure.

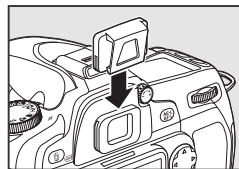



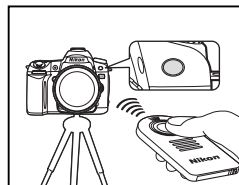

5 Aim the transmitter on the ML-L3 at the infrared receiver on the camera and press the shutter-release button on the ML-L3. In delayed remote mode, the self-timer lamp will light for about two seconds before the shutter is released. In quick-response remote mode, the self-timer lamp will flash after the shutter has been released. If **AF-A** or **AF-S** is selected in autofocus mode (📷 29), the camera will return to stand-by mode without releasing the shutter if unable to focus. The camera will release the shutter without focusing in manual focus mode, if **AF-C** is selected in autofocus mode, or if the camera has already been focused using the camera shutter-release button (see step 3).



Remote control mode can be cancelled by selecting another shooting mode. Single-frame or continuous shooting mode will be restored if the camera is turned off or no operations are about one minute.

Using the Built-in Flash

If the flash is required, the camera will only respond to the shutter-release button on the ML-L3 once the flash has charged. In , , , and  modes, the flash will begin charging when delayed remote or quick-response remote mode is selected; once the flash is charged, it will pop up automatically if required when the shutter-release button on the ML-L3 is pressed. In **P**, **S**, **A**, and **M** modes, raising the flash during the two-second count-down in delayed remote mode will cancel the two-second timer. Wait for the flash to charge and then press the shutter-release button on the ML-L3 to restart the timer.

In flash-sync modes that support red-eye reduction, the red-eye reduction lamp will light for about one second before the shutter is released. In delayed remote mode, the self-timer lamp will blink for two seconds and then light for one second before the shutter is released.

1 — Beep (86)

This option controls the beeps that sound when the remote control is used.

30 — Remote on Duration (99)



Choose length of time the camera will remain in stand-by before remote control mode is cancelled.



Using the Built-in Flash



The camera supports a variety of flash modes for photographing poorly lit or backlit subjects.

Using the Built-in Flash: AUTO, , , and  Modes

- 1 Rotate the mode dial to select the desired mode.
- 2 Press the  button and rotate until the desired flash mode is displayed in the control panel ( 41).
- 3 Take pictures. The flash will pop up as required when the shutter-release button is pressed halfway, and fire when a photograph is taken.



Using the Built-in Flash: P, S, A, and M Modes

- 1 Rotate the mode dial to select the desired mode.
- 2 Press the  button to raise the flash.
- 3 Press the  button and rotate until the desired flash mode is displayed in the control panel ( 41).
- 4 Select a metering method and set exposure.
- 5 Take pictures. The flash will fire whenever a picture is taken.

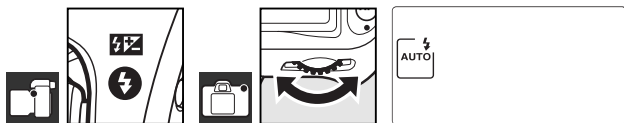

Lowering the Built-in Flash

To save power when the flash is not in use, press it gently downward until the latch clicks into place.

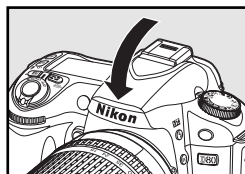

Flash Mode

The current flash mode is displayed in the control panel as shown below.

 is displayed when the flash is off.

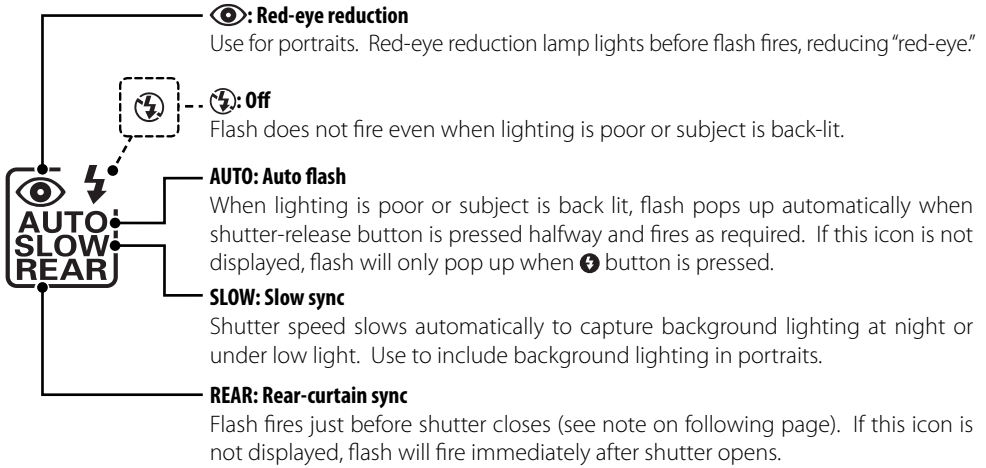
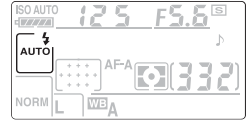

The flash modes available depend on the mode currently selected with the mode dial.

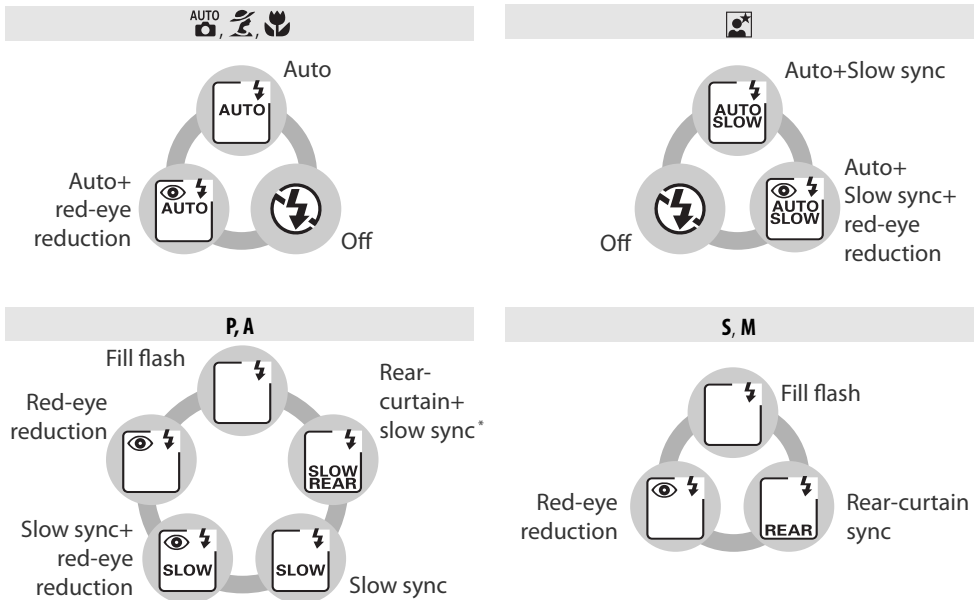



* **SLOW** is displayed after main command dial is released.

The Built-in Flash

Use with CPU lenses with focal lengths of 18–300mm or non-CPU lenses with focal lengths of 18–200mm ( 118; note that auto flash level control is available with CPU lenses only). Remove lens hoods to prevent shadows. Lenses that block the subject's view of the red-eye reduction lamp may interfere with red-eye reduction. The flash has a minimum range of 60 cm (2 ft.) and can not be used in the macro range of macro zoom lenses.

If the flash fires in continuous shooting mode ( 36), only one picture will be taken each time the shutter-release button is pressed.

The shutter release may be briefly disabled to protect the flash after it has been used for several consecutive shots. The flash can be used again after a short pause.

See the Appendix for more about the built-in flash, including flash control, shutter sync speeds, and range. For information on optional flash units (Speedlights), see “Optional Flash Units (Speedlights)” ( 119). See “FV Lock” for information using FV lock ( 92).

Rear-Curtain Sync

Normally the flash fires as the shutter opens (“front-curtain sync”; see below at left). In rear-curtain sync, the flash fires just before the shutter closes, creating the effect of a stream of light behind moving subjects.



Front-curtain sync



Rear-curtain sync

22 — Built-in Flash (95)

Choose how the built-in flash fires.



26 — Modeling Flash (98)

Preview the effects of the flash.

ISO Sensitivity

Controls used:  button + main command dial (monitor off)

“ISO sensitivity” is the digital equivalent of film speed. The higher the ISO sensitivity, the less light needed to make an exposure, allowing higher shutter speeds or smaller apertures.

ISO sensitivity can be set between values roughly equivalent to ISO 100 and ISO 1600 in steps equivalent to $\frac{1}{3}$ EV. Values over 1600 are displayed as **H 0.3** (ISO 2000 equivalent), **H 0.7** (ISO 2500 equivalent), and **H 1.0** (ISO 3200 equivalent).  (auto) and Digital Vari-Program modes also offer an **Auto** setting that allows the camera to set ISO sensitivity automatically in response to lighting conditions. The default setting for  (auto) and Digital Vari-Program modes is **Auto**, the default setting for **P**, **S**, **A**, and **M** modes **100**.

ISO sensitivity can be selected by pressing the **ISO** button and rotating the main command dial until the desired setting is displayed in the control panel. ISO sensitivity can also be adjusted from the shooting menu ( 83).





High ISO NR (83)



The higher the ISO sensitivity, the more likely pictures are to be subject to “noise” in the form of randomly-spaced, brightly-colored pixels. Photos taken at ISO sensitivities over ISO 1600 will likely contain appreciable amounts of noise. The **High ISO NR** option in the shooting menu can be used to reduce noise at ISO sensitivities of 400 or more.

7 — ISO Auto (88)









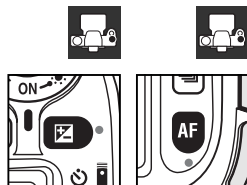

This option can be used to enable automatic ISO sensitivity control in **P**, **S**, **A**, and **M** modes. Sensitivities of **H 0.3**, **H 0.7**, and **H 1.0** are not available when **ISO auto** is on.

Two-Button Reset

Controls used:  button +  button











The camera settings listed below can be restored to default values by holding the  and  buttons down together for more than two seconds (these buttons are marked by a green dot). The control panel turns off briefly while settings are reset. Custom Settings are not affected.



Option	Default
Shooting mode  36–39	Single frame
Image quality  34, 81	JPEG Normal
Image size  35, 81	Large
ISO sensitivity  43, 83	
 Digital Vari-Program	Auto
P, S, A, M	100
White balance  58–60, 82)*	Auto
Autofocus mode  29	AF-A
Focus area  30)†	Center
Metering  52	Matrix
AE lock hold  53	Off

* Fine-tuning reset to 0, **Choose color temp.** reset to 5000K.

† Focus area not displayed if **Auto-area AF** is selected for Custom Setting 2 (**AF-area mode**).

Option	Default
Flexible program  47	Off
Exposure compensation  54	±0
Bracketing  56–57)	±0‡
Flash exposure compensation  55	±0
FV lock  92–93)	Off
Flash sync mode  40–42)	
  	Auto front-curtain sync
	Auto slow sync
P, S, A, M	Front-curtain sync
Multiple exposure  84–85)	Off

‡ Number of shots reset to zero. Bracketing increment reset to 1 EV (exposure/flash bracketing) or 1 (white balance bracketing).

Default Settings

See the Appendix for a list of default settings  134–137).

P, S, A, and M Modes

P, **S**, **A**, and **M** modes offer control over a variety of advanced settings, including exposure (📷 52), white balance, and image optimization. Each of these modes offers a different degree of control over shutter speed and aperture:

	Mode	Description
P	Programmed auto (📷 47)	Camera sets shutter speed and aperture for optimal exposure. Recommended for snapshots and in other situations in which there is little time to adjust camera settings.
S	Shutter-priority auto (📷 48)	User chooses shutter speed; camera selects aperture for best results. Use to freeze or blur motion.
A	Aperture-priority auto (📷 49)	User chooses aperture; camera selects shutter speed for best results. Use to blur background or bring both foreground and background into focus.
M	Manual (📷 50)	User controls both shutter speed and aperture. Set shutter speed to "bulb" or "--" for long time-exposures.

📷 Lens Aperture Ring

When using a CPU lens equipped with an aperture ring (📷 117), lock the aperture ring at the minimum aperture (highest f-number). Type G lenses are not equipped with an aperture ring.

Non-CPU lenses can only be used in exposure mode M, when aperture can be adjusted manually using the lens aperture ring (in other modes, the shutter-release will be disabled). The camera exposure meter, ISO Auto, and variety of other features can not be used (📷 117).

📷 Custom Settings

Use Custom Setting 7 (**ISO auto**; 📷 88) to enable auto ISO sensitivity control in P, S, A, and M modes. Custom Setting 10 (**EV step**; 📷 89) determines the size of the increments used for exposure control. Custom Setting 15 (**Command Dials**; 📷 91) determines the roles played by the main and sub-command dials in setting shutter speed and aperture.

Exposure

The exposure (brightness) of photographs is determined by the amount of light that falls on the image sensor (CCD) while the shutter is open. Two factors that determine exposure are shutter speed and aperture.

Aperture refers to the size of the opening through which the light passes. The larger the aperture, the greater the amount of light that passes through the opening and the brighter the exposure. Smaller apertures mean less light and darker exposures. The camera displays show aperture in “f-numbers”: the larger the f-number, the smaller the aperture.

Shutter speed determines how long the shutter is open. The slower the shutter speed, the longer the image sensor is exposed to light and the brighter the exposure. Faster shutter speeds mean that the image sensor is exposed to light for less time, producing darker exposures.

The relationship between shutter speed and aperture can be likened to filling a cup from a tap. In this analogy, the amount of water needed to fill the cup is the amount of light needed for optimal exposure. If the cup overflows, the picture will be overexposed. If the cup doesn't fill, the picture will be underexposed. The amount the tap is opened is the aperture, and the length of time the tap is opened the shutter speed. Open up the tap and the cup will fill in less time; tighten the tap and more time will be needed to fill the cup.

Just as a cup can be filled in different times using different tap settings, different combinations of shutter speed and aperture can be used to produce the same exposure. The results, however, will be very different: fast shutter speeds and larger apertures freeze moving objects and soften background details, while slow shutter speeds and small apertures blur moving objects and bring out background details.



Fast shutter speed ($1/1,600$ s)



Slow shutter speed (1 s)



Small aperture (f/36)



Large aperture (f/3)

(Remember, the larger the f-number, the smaller the aperture.)

Mode P (Programmed Auto)

In this mode, the camera automatically adjusts shutter speed and aperture for optimal exposure in most situations. This mode is recommended for snapshots and other situations in which you want to leave the camera in charge of shutter speed and aperture.

To take photographs in programmed auto:

1 Rotate the mode dial to **P**.

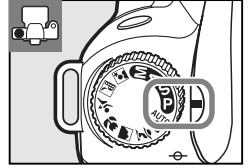

2 Frame a photograph, focus, and shoot.

Flexible Program

In mode **P**, different combinations of shutter speed and aperture can be selected by rotating the main command dial (“flexible program”). Rotate the main command dial to the right for large apertures (small f-numbers) that blur background details or fast shutter speeds that “freeze” motion. Rotate the main command dial to the left for small apertures (large f-numbers) that increase depth of field or slow shutter speeds that blur motion. All combinations produce the same exposure. While flexible program is in effect, a  indicator appears in the control panel. To restore default shutter speed and aperture settings, rotate the main command dial until the indicator is no longer displayed, choose another mode, or turn the camera off.

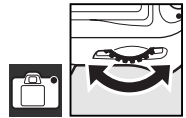

Shutter speed: $1/250$ s
Aperture: f/8



Shutter speed: $1/2,000$ s
Aperture: f/2.8
(Large aperture)

The exposure program for mode **P** is given in the appendix ( 139).

Mode S (Shutter-Priority Auto)

In shutter-priority auto, you choose the shutter speed from values between 30 s and $\frac{1}{4,000}$ s while the camera automatically selects the aperture that will produce the optimal exposure. Use slow shutter speeds to suggest motion by blurring moving subjects, high shutter speeds to “freeze” motion.

To take photographs in shutter-priority auto:

1 Rotate the mode dial to **S**.

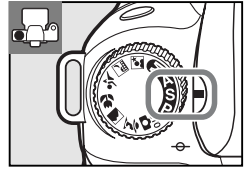

2 Rotate the main command dial to choose the desired shutter speed.

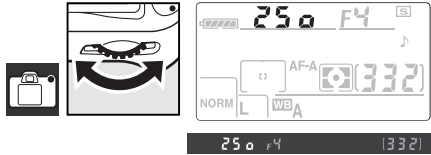

3 Frame a photograph, focus, and shoot.



Shutter speed: $\frac{1}{1,600}$ s



Shutter speed: 1 s

Flashing Shutter-Speed Display

See “Camera Error Messages and Displays” (📖 132) for information on what to do if flashing “bulb” or “- -” indicators appear in the shutter-speed displays.

Mode A (Aperture-Priority Auto)

In aperture-priority auto, you choose the aperture from values between the minimum and maximum for the lens while the camera automatically selects the shutter speed that will produce the optimal exposure. Small apertures (high f-numbers) increase depth of field, bringing both the main subject and background into focus. Large apertures (low f-numbers) soften background details.

To take photographs in aperture-priority auto:

1 Rotate the mode dial to **A**.

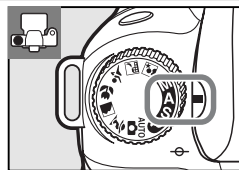

2 Rotate the sub-command dial to choose the desired aperture.

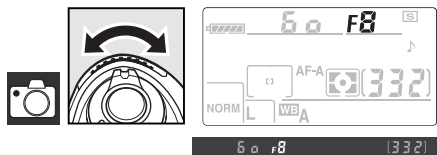

3 Frame a photograph, focus, and shoot.

Depth of Field

“Depth of field” is the distance to which objects behind and in front of the focus point appear to be in focus. Large apertures (low f-numbers) reduce depth of field, blurring objects behind and in front of the main subject. Small apertures (high f-numbers) increase depth of field, bringing out details in the background and foreground (note that depth of field is also influenced by other factors, such as focal length and focus distance). Short field depths are generally used in portraits to blur background details, long field depths in landscape photographs to bring the foreground and background into focus.

To preview depth of field, press and hold the depth-of-field preview button. The lens will be stopped down to the current aperture value, allowing depth of field to be previewed in the viewfinder.

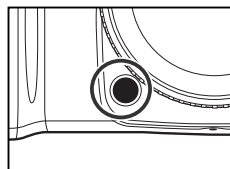

Mode M (Manual)

In manual exposure mode, you control both shutter speed and aperture. Shutter speed can be set to values between 30s and $\frac{1}{4,000}$ s, or the shutter can be held open for indefinitely for longer exposures (**b u l b**). Aperture can be set to values between the minimum and maximum values for the lens.

To take photographs in manual exposure mode:

- 1 Rotate the mode dial to **M**.

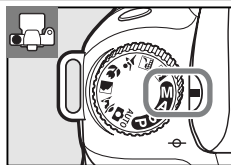

- 2 Rotate the main command dial to choose a shutter speed, and the sub-command dial to set aperture. Check exposure in the electronic analog exposure displays (see below).

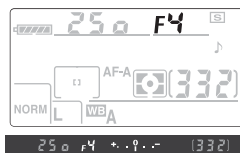
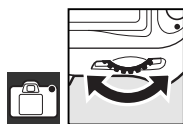

- 3 Frame a photograph, focus, and shoot.



Shutter speed: $\frac{1}{60}$ s, Aperture: f/4.5

Electronic Analog Exposure Display

If a CPU lens is attached and a shutter speed other than **b u l b** is selected, the electronic analog exposure displays in the control panel and viewfinder show whether the photograph would be under- or over-exposed at current settings. Depending on the option chosen for Custom Setting 10 (**EV step**; 89), the amount of under- or over-exposure is shown in increments of $\frac{1}{3}$ EV or $\frac{1}{2}$ EV. If the limits of the exposure metering system are exceeded, the displays will flash.

EV Step set to "1/3 step"	EV Step set to "1/2 step"
+ . 0 . . -	+ . . 0 . . -
Optimal exposure	Optimal exposure
Underexposed by $\frac{1}{3}$ EV	Underexposed by $\frac{1}{2}$ EV
+ . . 0 . . -	+ . . 0 . . -
Overexposed by more than 2 EV	Overexposed by more than 3 EV
+ . . . 0 . . -	+ . . . 0 . . -

Long Time-Exposures

Shutter speeds of "bulb" and "--" can be used for long time-exposure photographs of moving lights, the stars, night scenery, or fireworks. To prevent blurring caused by camera shake, use a tripod and an optional remote control (📷 123) or remote cord (📷 123).

Shutter speed	Description
bulb	Shutter remains open while the shutter-release button is held down.
--	Optional ML-L3 remote control required (📷 123). Select mode M, choose a shutter speed of "bulb," and then select delayed remote or quick-response remote mode (📷 38). Shutter opens when the shutter-release button on the remote control is pressed and until the button is pressed a second time or remains open for thirty minutes.



Shutter speed: 35 s, Aperture: f/25





To prevent loss of power before the exposure is complete, use a fully charged battery or an optional AC adapter. Note that noise may be present in long exposures; before shooting, choose **On** for the **Long exp. NR** option in the shooting menu (📷 83).

Exposure

Metering

Controls used:  button + main command dial

The metering method determines how the camera sets exposure. The following options are available:

Method	Description
 3D Color Matrix II	Recommended in most situations. Camera meters a wide area of the frame and sets exposure according to distribution of brightness, color, distance, and composition for natural results.
 Center-weighted	Camera meters entire frame but assigns greatest weight to center area. Classic meter for portraits; recommended when using filters with an exposure factor (filter factor) over $1 \times$  122).
 Spot	Camera meters circle 3.5 mm (0.14 in.) in diameter (approximately 2.5 % of frame). Circle is centered on current focus area, making it possible to meter off-center subjects (if non-CPU lens is used or if Auto-area AF is selected for Custom Setting 2 ( 87), camera will meter center focus area). Ensures that subject will be correctly exposed, even when background is much brighter or darker.

To choose a metering method, press the  button and rotate the main command dial until the desired mode is displayed.

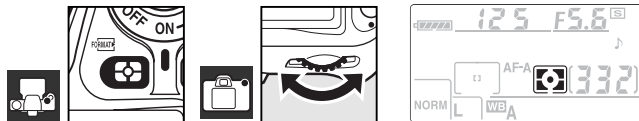

12—Center Weight (90)

This option controls the size of the area assigned the greatest weight in center-weighted metering. The default is 8mm (0.31 in.).

3D Color Matrix II Metering

In matrix metering, exposure is set using a 420-segment RGB sensor. Use a type G or D lens for results that include range information (3D color matrix metering II;  117). With other CPU lenses, 3D range information is not included (color matrix metering II).

Autoexposure Lock

Controls used: AE-L/AF-L button

Use auto exposure lock to recompose photographs after metering exposure:

- 1 Select mode **P**, **S**, or **A** and choose center-weighted or spot metering (exposure lock has no effect in mode **M**, while ^{AUTO} and Digital Vari-Program modes are not recommended as center-weighted and spot metering are not available in these modes). If using center-weighted metering, select the center focus area with the multi selector (30).



- 2 Position the subject in the selected focus area and press the shutter-release button halfway. With the shutter-release button pressed halfway and the subject positioned in the focus area, press the **AE-L/AF-L** button to lock exposure.

While exposure lock is in effect, an **AE-L** indicator will appear in the viewfinder.

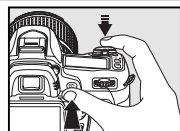

- 3 Keeping the **AE-L/AF-L** button pressed, recompose the photograph and shoot.



Adjusting Shutter Speed and Aperture

While exposure lock is in effect, the following settings can be adjusted without altering the metered value for exposure.

Mode	Setting
Programmed auto	Shutter speed and aperture (flexible program; 47)
Shutter-priority auto	Shutter speed
Aperture-priority auto	Aperture

The new values can be confirmed in the viewfinder and control panel. Note that the metering method can not be changed while exposure lock is in effect (changes to metering take effect when the lock is released).

18 — AE-L/AF-L (94)

This option controls the behavior of the **AE-L/AF-L** button.

19 — AE Lock (94)

This option controls whether the shutter-release button locks exposure.



Exposure Compensation

Controls used:  button + main command dial

Exposure compensation is used to alter exposure from the value suggested by the camera, making pictures brighter or darker. It is most effective when used with center-weighted or spot metering ( 52).

Exposure compensation is available in modes **P**, **S**, and **A** (in mode **M**, only the exposure information shown in the electronic analog exposure display is affected; shutter speed and aperture do not change).

Press the  button and rotate the main command dial until the desired value is displayed in the control panel. Exposure compensation can be set to values between -5EV (underexposure) and $+5\text{EV}$ (overexposure) in increments of $\frac{1}{3}\text{EV}$. In general, choose positive values to make the subject brighter, negative values to make it darker.

At values other than ± 0 , a  icon will be displayed after you release the  button. The current value for exposure compensation will be displayed in the viewfinder when the  button is pressed.

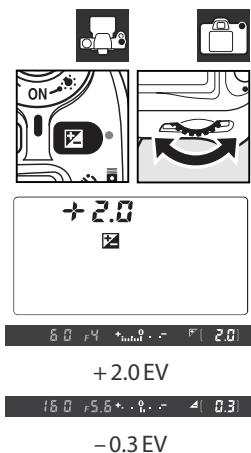

-1 EV



No exposure compensation



+1 EV

Normal exposure can be restored by setting exposure compensation to ± 0 . Exposure compensation is not reset when the camera is turned off.

10 — EV Step (89)

Use this option to set the increments for exposure compensation to $\frac{1}{2}\text{EV}$.



11 — Exposure Comp. (89)

If desired, exposure compensation can be set without pressing the  button.

Flash Exposure Compensation

Controls used:  button + sub command dial

Flash exposure compensation is used to alter flash output from the level suggested by the camera, changing the brightness of the main subject relative to the background. Flash output can be increased to make the main subject appear brighter, or reduced to prevent unwanted highlights or reflections.

Press the  () button and rotate the sub-command dial until the desired value is displayed in the control panel. Flash compensation can be set to values between -3 EV (darker) and $+1$ EV (brighter) in increments of $\frac{1}{3}$ EV. In general, choose positive values to make the subject brighter, negative values to make it darker.

At values other than ± 0 , a  icon will be displayed after you release the  () button. The current value for flash compensation will be displayed in the viewfinder when the  button is pressed.

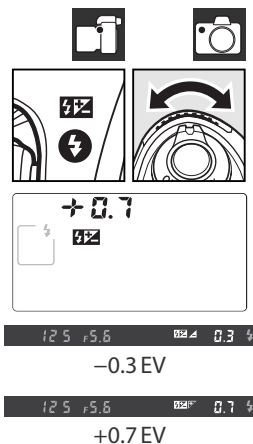

Normal flash output can be restored by setting flash compensation to ± 0.0 . Flash exposure compensation is not reset when the camera is turned off.

Using Flash Exposure Compensation with Optional Speedlights

Flash exposure compensation is also available with an optional SB-800, SB-600, SB-400, or SB-R200 Speedlights.

10 — EV Step (89)

Use this option to set the increments for flash compensation to $\frac{1}{2}$ EV.

Bracketing

Controls used: **BKT** button + command dials

Bracketing automatically varies selected settings slightly with each shot, “bracketing” the current value. The setting affected is chosen with Custom Setting 13 (**Auto BKT set**; 90); Below, it is assumed that **AE & flash** is selected to vary exposure and flash level. Other options can be used to vary exposure or flash level separately or to bracket white balance.

- 1 Press the **BKT** button and rotate the main command dial to choose the number of shots in the bracketing sequence (two or three).

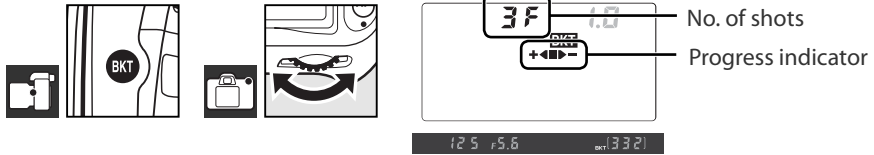

- 2 Press the **BKT** button and rotate the sub-command dial to choose the bracketing increment from values between 0.3 EV and 2.0 EV.



Understanding the Bracketing Display

Number of shots	Progress indicator	Description
3F	+<->-	3 shots: unmodified, negative, positive
+2F	+<-	2 shots: unmodified, positive
--2F	->-	2 shots: unmodified, negative

Bracketing Programs

See the Appendix for a list of bracketing programs (140).



10 — EV Step (89)

Use this option to set the increments for exposure and flash bracketing to ½ EV.

14 — Auto BKT Order (91)

This option can be used to change the bracketing order.

3 Compose a photograph, focus, and shoot. The camera will vary exposure and flash level with each shot. At default settings, the first shot will be taken at the current values for exposure and flash compensation and the following shots at modified values. If the bracketing sequence consists of three shots, the bracketing increment will be subtracted from the current values in the second shot and added in the third shot, “bracketing” the current values. The modified values can be higher or lower than the maximum and minimum values for exposure and flash compensation. The modified shutter speed and aperture are displayed in the control panel and viewfinder.

While bracketing is in effect, a bracketing progress indicator will be displayed in the control panel. The  segment will disappear from the indicator when the unmodified shot is taken, the  indicator when the shot with the negative increment is taken, and the  indicator when the shot with the positive increment is taken.

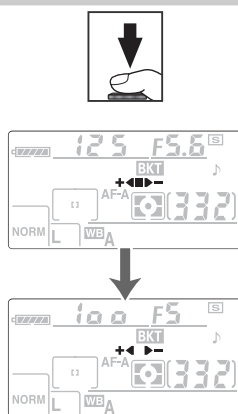



To cancel bracketing, press the  button and rotate the main command dial until the number of shots in the bracketing sequence is zero and **BKT** is no longer displayed in the control panel. The program last in effect will be restored the next time bracketing is activated.

Exposure Bracketing

The camera modifies exposure by varying shutter speed and aperture (programmed auto), aperture (shutter-priority auto), or shutter speed (aperture-priority auto, manual exposure mode). When **On** is selected for Custom Setting 7 (**ISO Auto**;  88), the camera will automatically vary ISO sensitivity for optimum exposure when the limits of the camera exposure system are exceeded. In exposure bracketing, shutter speed will only be changed after the camera has adjusted ISO sensitivity.

Exposure and Flash Bracketing

In continuous mode, shooting will pause after the number of shots specified in the bracketing program. Selecting  or Digital Vari-Program modes will cancel bracketing; bracketing will resume when mode **P**, **S**, **A**, or **M** is selected. Exposure and flash bracketing are cancelled when **WB bracketing** is selected for Custom Setting 13 (**Auto BKT set**;  90).







Resuming Exposure or Flash Bracketing

If the memory card fills before all shots in the sequence have been taken, shooting can be resumed from the next shot in the sequence after the memory card has been replaced or shots have been deleted to make room on the memory card. If the camera is turned off before all shots in the sequence have been taken, bracketing will resume from the next shot in the sequence when the camera is turned on.

White Balance

Controls used: WB button + main command dial (monitor off)

White balance ensures that colors are unaffected by the color of the light source. Auto white balance is recommended for most light sources; if necessary, other values can be selected according to the type of source. The following options are available:

Option	Description
A Auto	Camera sets white balance automatically. Recommended for most situations.
 Incandescent	Use under incandescent lighting.
 Fluorescent	Use under fluorescent lighting.
 Direct Sunlight	Use with subjects lit by direct sunlight.
 Flash	Use with built-in flash or optional Nikon flash units.
 Cloudy	Use in daylight under overcast skies.
 Shade	Use in daylight with subjects in the shade.
 Choose color temp.	Choose color temperature from list of values (82).
PRE White balance preset	Use gray or white object or existing photograph as reference for white balance (82).

To select a value for white balance, press the **WB** button and rotate the main command dial until the desired setting is displayed in the control panel. White balance can also be adjusted from the shooting menu (82).



Fine-Tuning White Balance

Controls used: WB button + sub-command dial (monitor off)

At settings other than  (**Choose color temp.**) and **PRE (White balance preset)**, white balance can be “fine tuned” by ± 3 in increments of one. Choose lower values to make photographs appear slightly more yellow or red, higher values to lend images a bluish tinge.

Press the **WB** button and rotate the sub-command dial until the desired setting is displayed in the control panel.





During shooting, settings other than ± 0 are displayed in the control panel as shown at right.



Choosing a Color Temperature

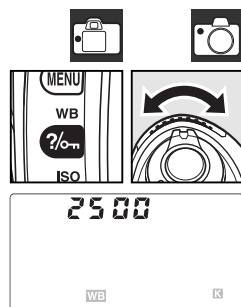

Controls used: WB button + sub-command dial (monitor off)

At a setting of  (**Choose color temp.**), color temperature can be selected by pressing the **WB** button and rotating the sub-command dial until the desired value is displayed in the control panel. Color temperature can also be selected in the shooting menu ( 82).





Preset White Balance

Preset white balance can be used when the desired results can not be achieved at other settings or to match white balance to the value used in an previous photograph. Two methods are available for setting preset white balance:

Method	Description
Direct measurement	Neutral gray or white object is placed under lighting that will be used in final photograph and white balance is measured by camera ( 60).
Copy from existing photograph	White balance is copied from photo on memory card ( 82).

Choose color temp.

Take a test shot to determine if the selected color temperature is appropriate to the light source. Note that the desired results may not be achieved with the flash or with fluorescent lighting; choose  (**Flash**) or  (**Fluorescent**) instead.

Color Temperature

The perceived color of a light source varies with the viewer and other conditions. Color temperature is an objective measure of the color of a light source, defined with reference to the temperature to which an object would have to be heated to radiate light in the same wavelengths. While light sources with a color temperature in the neighborhood of 5,000–5,500K appear white, light sources with a lower color temperature, such as incandescent light bulbs, appear slightly yellow or red. Light sources with a higher color temperature appear tinged with blue. The color temperatures for each of the white balance settings supported by the camera may be found in the Appendix ( 140).

13 — Auto BKT Set (90)

This option to create a series of photographs “bracketing” the current white balance value.

Measuring a Value for Preset White Balance

- 1 Place a neutral gray or white object under the lighting that will be used in the final photograph. A standard gray card can be used as a reference in studio settings. Do not use exposure compensation.
- 2 Press the **WB** button and rotate the main command dial until **PRE** is displayed in the control panel.



- 3 Release the **WB** button briefly and then press the button until displays start to flash as shown at right. To exit without measuring a new value for white balance, press the **WB** button.

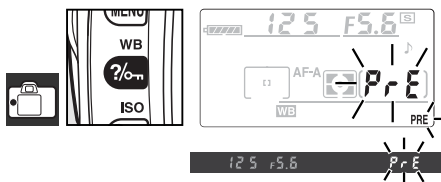

- 4 Frame the reference object so that it fills the viewfinder and press the shutter-release button all the way down. The camera will measure a value for white balance and use this value when preset white balance is selected. No photograph will be recorded.



To exit without measuring a new value for white balance, press the **WB** button.

- 5 If the camera was able to measure a value for white balance, the displays will flash as shown at right for about six seconds before the camera returns to shooting mode (to return to shooting mode before the display stops flashing, press the shutter-release button halfway). White balance will automatically be set to the measured value.

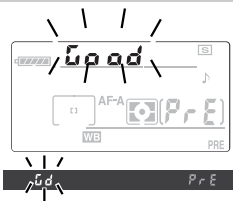

If the displays flash as shown at right, the camera was unable to measure white balance. Press the shutter-release button halfway to return to Step 4 and measure white balance again.









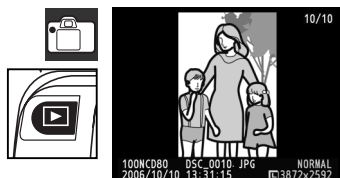





More on Playback

Viewing Photographs on the Camera

To view photographs in the monitor, press the  button. Photographs taken in “tall” (portrait) orientation are displayed in tall orientation as shown at right.



The following operations can be performed in full-frame playback:

To	Use	Description
View additional photographs	 or 	Press multi selector to right or rotate main command dial right to view photographs in order recorded. Press multi selector left or rotate main command dial left to view photographs in reverse order.
View photo information	 or 	Press multi selector up or down or rotate sub-command dial to view information about current photograph (Ⓝ 62).
Zoom in on photo		Zoom in on current photograph (Ⓝ 64).
Delete photo		Delete current photograph (Ⓝ 65).
Protect photo		Protect current photograph (Ⓝ 65).
View thumbnails		View multiple photographs (Ⓝ 63).
Exit to shooting mode	Shutter button or 	To turn monitor off and return to shooting mode, press shutter-release button halfway or press the  button.
View menus		View menus (Ⓝ 74).
Retouch photo		Create retouched copy of current photograph (Ⓝ 109).

Auto Image Rotation (Ⓝ 108)/**Rotate Tall** (Ⓝ 75)

These options control whether photographs taken in “tall” orientation are rotated for display in the monitor during playback.

6 — Image Review (Ⓝ 88)

Choose whether to display photographs as they are taken.

27 — Monitor Off (Ⓝ 98)

Choose how long the monitor remains on before turning off automatically to save power.

Photo Information

Photo information is superimposed on images displayed in full-frame playback. Press the multi selector up or down or rotate the sub-command dial to cycle through the following information: Basic Information ↔ Shooting Data Page 1 ↔ Shooting Data Page 2 ↔ Retouch History (retouched copies only) ↔ Highlights ↔ RGB Histogram ↔ Basic Information.

Basic Information

1 Protect status..... 65	5 Image quality..... 34
2 Retouch indicator 109	6 Date of recording14, 103
3 Frame number/total number of images	7 Time of recording14, 103
4 Folder name..... 75	8 File name..... 35
	9 Image size..... 35

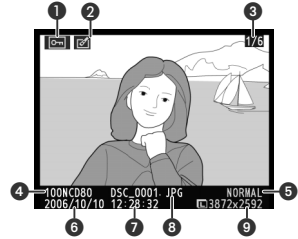

Shooting Data, Page 1

1 Protect status..... 65	7 Mode 45
2 Retouch indicator 109	8 Exposure compensation .. 54
3 Camera name	9 Focal length..... 1
4 Metering..... 52	10 Flash mode 40
5 Shutter speed..... 48, 50	11 Frame number/total number of images
6 Aperture 49, 50	

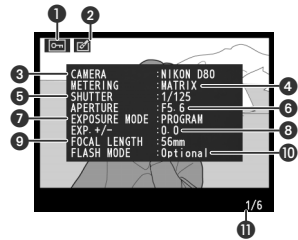

Shooting Data, Page 2

1 Protect status..... 65	7 Tone compensation 80
2 Retouch indicator 109	8 Sharpening 80
3 Image optimization ¹ 79	9 Color mode/hue..... 80
4 ISO sensitivity ² 43	10 Saturation 80
5 White balance/white balance fine-tuning..... 58	11 Image comment ³ 104
6 Image size/ image quality..... 34, 35	12 Frame number/total number of images

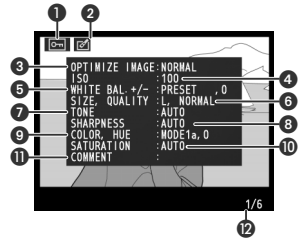

1. Filter name is displayed if photo was taken with filter option selected for **Optimize image > Black-and-white > Custom**.
2. Displayed in red if ISO sensitivity was modified from selected value by auto ISO.
3. Only first 13 letters are displayed.

Retouch History¹

1 Protect status..... 65
2 Retouch indicator 109
3 Retouch history: Lists changes made to image using options in retouch menu (109), starting with most recent change.. 109
4 Frame number/total number of images

1. Displayed if image was created using options in retouch menu.

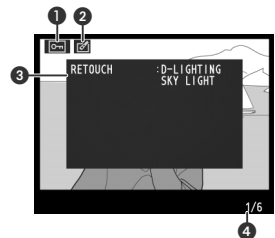

Highlights

Highlights are areas of the image in which details may be lost (“washed out”) due to overexposure. Use the highlight display as a guide when adjusting exposure.

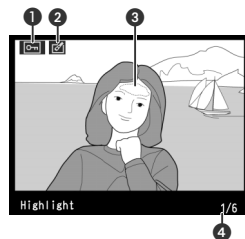

- 1 Protect status.....65
- 2 Retouch indicator 109
- 3 Image highlights (areas of image that are “washed out”) are indicated by flashing border
- 4 Frame number/total number of images

RGB Histogram

A histogram is a graph showing the distribution of tones in the image. The horizontal axis corresponds to pixel brightness, with dark pixels at the left and bright pixels at the right. The vertical axis shows the number of pixels of each brightness in the image. Note that camera histograms may differ from those displayed in imaging applications.

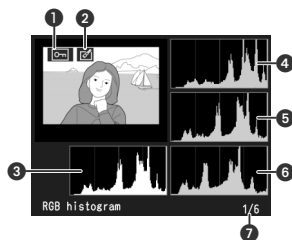







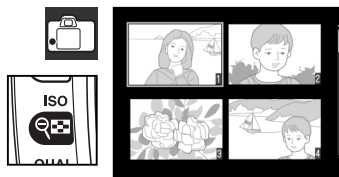





- 1 Protect status.....65
- 2 Retouch indicator 109
- 3 Histogram (all channels)
- 4 Red channel histogram
- 5 Green channel histogram
- 6 Blue channel histogram
- 7 Frame number/total number of images

Viewing Multiple Images: Thumbnail Playback

To display images in “contact sheets” of four or nine images, press the  button in full-frame playback. The following operations can be performed while thumbnails are displayed:



















To	Use	Description
Display more images per page		Increase number of images displayed from one (full-frame playback) to four or from four to nine.
Display fewer images per page		Decrease number of images displayed from nine to four or from four to one (full-frame playback).
Highlight photographs		Use multi selector to highlight photographs, or rotate main command dial to move cursor up or down, sub-command dial to move cursor left or right.
View highlighted picture full frame		View picture highlighted in thumbnail list full frame.
Delete photo		Delete highlighted photograph ( 65).
Protect photo		Protect highlighted photograph ( 65).
Exit to shooting mode	Shutter button or 	To turn monitor off and return to shooting mode, press shutter-release button halfway or press the  button.
View menus		View menus ( 74).



Taking a Closer Look: Playback Zoom



Press the  button to zoom in on a photograph in full-frame playback. The following operations can be performed:





To	Use	Description
Zoom in and out	 / 	Press  to zoom in to maximum of approximately 25× (large images), 19× (medium images) or 13× (small images). Press  to zoom out. While photo is zoomed in, press multi selector up, down, left, or right to view areas of image not visible in monitor. Keep multi selector pressed to scroll rapidly to other areas of frame. Navigation window is displayed when zoom ratio is altered; area currently visible in monitor is indicated by yellow border. 
View other areas of image		
View other images		Rotate main command dial to view same location in other images at current zoom ratio.
Cancel zoom		Return to full-frame playback.
Delete photo		Delete current photograph ( 65).
Protect photo		Protect current photograph ( 65).
Exit to shooting mode	Shutter button or 	To turn monitor off and return to shooting mode, press shutter-release button halfway or press the  button.
View menus		View menus ( 74).

Protecting Photographs from Deletion

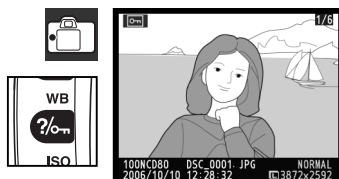

In full-frame, zoom, and thumbnail playback, the  button can be used to protect photographs from accidental deletion. Protected files can not be deleted using the  button or the **Delete** option in the playback menu, and have DOS “read-only” status when viewed on a Windows computer. Note that protected files *will* be deleted when the memory card is formatted ( 102).

Press the  button to protect the photograph currently displayed in full-frame or zoom playback or highlighted in the thumbnail list. The photograph will be marked with a  icon.



To remove protection from the photograph so that it can be deleted, press the  button when the photograph is displayed in full-frame or zoom playback or highlighted in the thumbnail list. To remove protection from all images in the folder or folders currently selected for **Playback Folder**, press the  and  buttons together for about two seconds.

Deleting Individual Photographs

Press the  button to delete the photograph currently displayed in full-frame or zoom playback or highlighted in the thumbnail list. One of the following confirmation dialogs will be displayed; press the  button again to delete the photograph. Press any other button to exit without deleting the photograph.

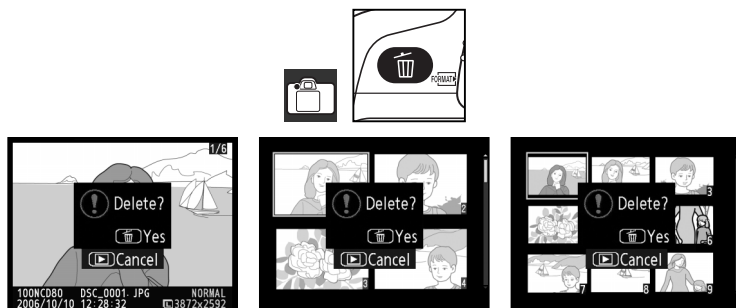

Delete 74

This option can be used to delete multiple photographs.

Connecting to a TV, Computer, or Printer

Viewing Photographs on TV

The supplied EG-D2 audio/video (A/V) cable can be used to connect the camera to a television or VCR for playback or recording. Background music included with Pictmotion slide shows (📺 75) will be played back over the television speakers.

- 1** Choose the appropriate video mode (📺 103).



- 2** Turn the camera off. Always turn the camera off before connecting or disconnecting the A/V cable.

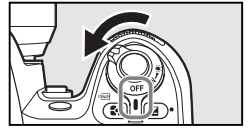

- 3** Connect the A/V cable as shown.

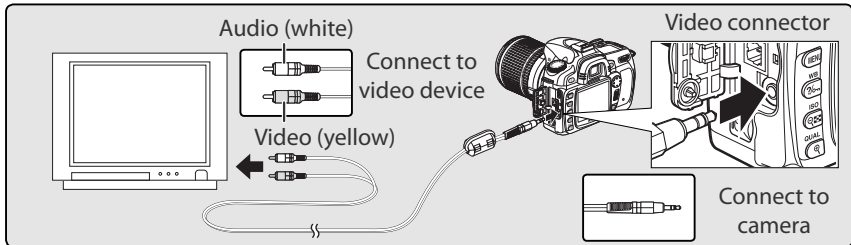

- 4** Tune the television to the video channel.

- 5** Turn the camera on. During playback, images will be displayed on the television or recorded to video tape; the camera monitor will remain off.

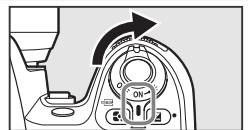

Use an AC Adapter

Use of an EH-5/EH-5a AC adapter (available separately) is recommended for extended playback. When the EH-5/EH-5a is connected, the camera monitor-off delay will be fixed at ten minutes and the exposure meters will remain on indefinitely.

Connecting to a Computer

This section describes how to connect the camera to a computer using the supplied UC-E4 USB cable. Once the camera is connected, Nikon Transfer (supplied) or optional Nikon software such as Camera Control Pro 2 or Camera Control Pro can be used to copy photographs to the computer or control the camera remotely.

Before Connecting the Camera

Install Nikon Transfer from the supplied Software Suite installer CD (see the *Quick Start Guide* for more information). To ensure that data transfer is not interrupted, be sure the camera battery is fully charged. If in doubt, charge the battery before connecting the camera or use an EH-5/EH-5a AC adapter (available separately).

Before connecting the camera, select the **USB** item in the camera setup menu and choose a USB option as described below.

Computer operating system*	USB
Windows Vista (32-bit Home Basic/ Home Premium/Business/Enterprise/ Ultimate editions)	Choose MTP/PTP or Mass Storage
Windows XP (Home Edition/Professional)	
Mac OS X (version 10.3.9 or 10.4.10)	
Windows 2000 Professional	Choose Mass Storage †

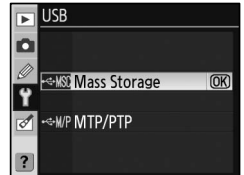

* See the websites listed on page x for the latest information on supported operating systems.

† Do NOT select **MTP/PTP**. If **MTP/PTP** is selected when the camera is connected, the Windows hardware wizard will be displayed. Click **Cancel** to exit the wizard, and then disconnect the camera and select **Mass Storage**.

Connecting the USB Cable

1 Turn the computer on and wait for it to start up.

2 Turn the camera off.

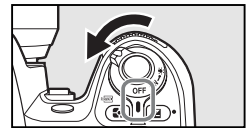

3 Connect the supplied UC-E4 USB cable as shown. Do not use force or attempt to insert the connectors at an angle. Connect the camera directly to the computer; do not connect the cable via a USB hub or keyboard.

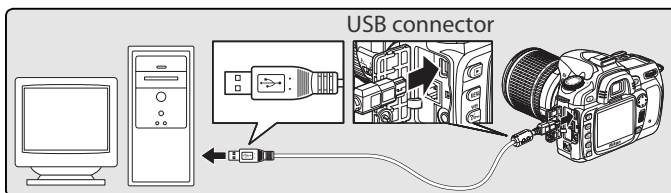

- 4 Turn the camera on. The computer will detect the camera automatically and display Nikon Transfer. If **Mass Storage** is selected for **USB**, the control panel and viewfinder will display the indicators shown at right (when **MTP/PTP** is selected, the normal shooting indicators are displayed).

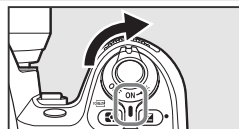

- 5 Transfer photographs to the computer as described in the online help for Nikon Transfer. To view the online help, start Nikon Transfer and select **Nikon Transfer help** from the Nikon Transfer **Help** menu.

- 6 If **MTP/PTP** is selected for **USB**, the camera can be turned off and the USB cable disconnected once transfer is complete. If **Mass Storage** is selected, the camera must first be removed from the system as described below.

Windows Vista/Windows XP

Click the "Safely Remove Hardware" icon in the taskbar (🔌) and select **Safely remove USB Mass Storage Device**.



Windows 2000 Professional

Click the "Unplug or Eject Hardware" icon in the taskbar (🔌) and select **Stop USB Mass Storage Device**.

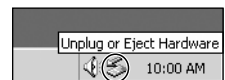

Mac OS X

Drag the camera volume ("NIKON D80") into the Trash. Note that Nikon Transfer will automatically remove the camera from the system when transfer is complete.

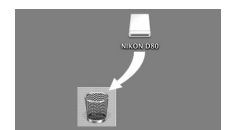

✓ **During Transfer**

Do not turn the camera off or disconnect the USB cable while transfer is in progress.

🖱️ **Camera Control Pro 2 and Camera Control Pro**

Camera Control Pro 2 and Camera Control Pro (both available separately; 123) can be used to operate the camera from a computer. Before connecting the camera, set the camera **USB** option (🔌 104) to **MTP/PTP**. When Camera Control Pro is running, the camera will show **P C** in place of the number of exposures remaining.

Camera Control Pro automatically checks for updates if an Internet connection is detected at startup.

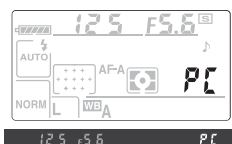

Printing Photographs

Photographs can be printed by any of the following methods:

- Connect the camera to a printer and print JPEG photographs directly from the camera (see below).
- Insert the camera memory card in a printer equipped with a card slot (see the printer manual for details). If the printer supports DPOF (📷 134), photographs can be selected for printing using **Print Set** (📷 73).
- Take the camera memory card to a developer or digital printer center. If the center supports DPOF, photographs can be selected for printing using **Print Set**.
- Transfer pictures (📷 67) and print them from a computer using ViewNX (supplied) or Capture NX (available separately; 📷 123). Note that this is the only method available for printing RAW (NEF) pictures.

Printing Via Direct USB Connection

JPEG photographs can be printed directly from a camera connected to a PictBridge printer (📷 134). When taking photographs for printing via direct USB connection in **P**, **S**, **A**, and **M** modes, choose **Ia (sRGB)** or **IIa (sRGB)** for the **Custom > Color mode** option in the **Optimize image** menu (📷 80).

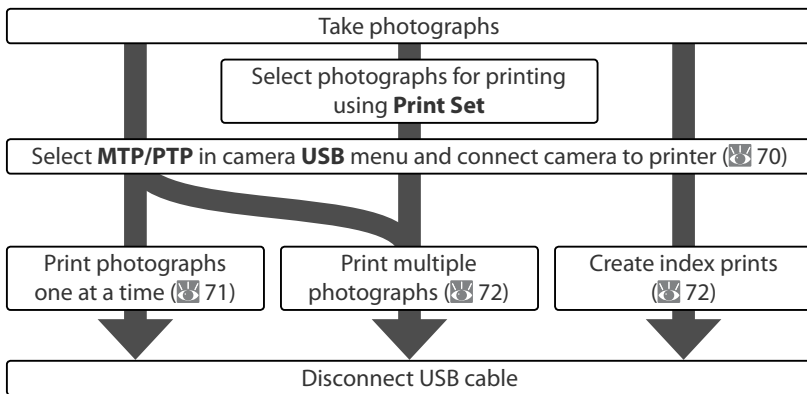

📷 Printing Via Direct USB Connection

If an error occurs during printing, the camera will display the dialog shown at right. After checking the printer, press the multi selector up or down to highlight **Continue** and press **OK** to resume printing. Select **Cancel** to exit without printing the remaining pages.

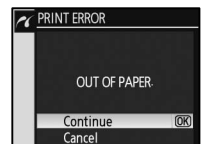

RAW (NEF) photographs can not be printed by direct USB connection. They are displayed in the Print Select menu but can not be selected for printing.

Connecting the Printer

Before printing, check that the camera battery is fully charged. If in doubt, charge the battery or use an EH-5/EH-5a AC adapter (available separately).

- 1** Set the camera **USB** option to **MTP/PTP** (104).



- 2** Turn the printer on.

- 3** Turn the camera off.



- 4** Connect the supplied UC-E4 USB cable as shown. Do not use force or attempt to insert the connectors at an angle. Connect the camera directly to the printer; do not connect the cable via a USB hub or keyboard.

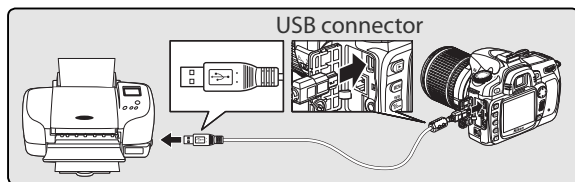

- 5** Turn the camera on. A welcome screen will be displayed, followed by the PictBridge playback display. Proceed to "Printing Pictures One at a Time" (71) or "Printing Multiple Pictures" (72).

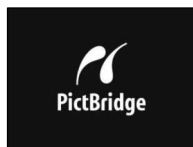
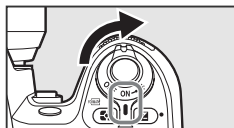



Press the multi selector left or right to view additional photographs, or press the button to zoom in on the current photo (64). To view six photographs at a time, press the button. Use the multi selector to highlight photographs, or press to display the highlighted photograph full frame.

Printing Pictures One at a Time

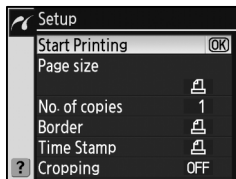
To print the picture currently selected in the PictBridge playback display, press **OK**. The menu shown at right will be displayed. Press the multi selector up or down to highlight an option and press to the right to select.



Option	Description
Start Printing	Print current picture. To cancel and return to PictBridge playback display before printing is complete, press OK . PictBridge playback display is shown when printing is complete.
Page Size	Menu shown at right will be displayed. Press multi selector up or down to choose page size from Printer Default (default page size for current printer), 3.5 x 5 in. , 5 x 7 in. , 100 x 150 mm , 4 x 6 in. , 8 x 10 in. , Letter , A3 , or A4 , then press OK to select and return to print menu.
No. of Copies	Menu shown at right will be displayed. Press multi selector up or down to choose number of copies (maximum 99), then press OK to select and return to print menu.
Border	Menu shown at right will be displayed. Press multi selector up or down to choose print style from Printer Default (default for current printer), Print with Border (print photo with white border), or No Border , then press OK to select and return to print menu.
Time stamp	Menu shown at right will be displayed. Press multi selector up or down to choose Printer Default (default for current printer), Print Time Stamp (print time and date of recording on photo), or No Time Stamp , then press OK to select and return to print menu.
Cropping	Menu shown at right will be displayed. To exit without cropping picture, highlight No cropping and press OK . To crop picture, highlight Crop and press multi selector right. If Crop is selected, dialog shown at right will be displayed. Use  and  buttons to choose size of crop and use multi selector to choose position of crop. Press OK to return to print menu.

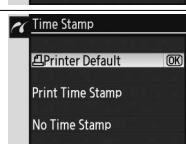
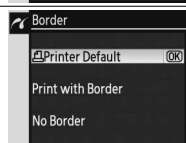
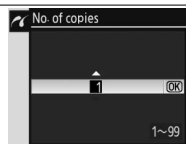
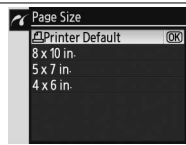

Page Size, Border, and Time Stamp

Choose printer default to print at current printer settings. Only options supported by the current printer can be selected.

Printing Multiple Pictures

To print multiple pictures or create an index print listing all JPEG photographs as small thumbnail images, press the **MENU** button in the PictBridge playback display. The menu shown at right will be displayed. Press the multi selector up or down to highlight an option and press to the right to select.

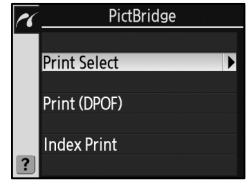

Option	Description
Print Select	Print selected pictures (see below).
Print (DPOF)	Print current DPOF print order (73).
Index Print	Create index print of all JPEG photos, to maximum of 256. Confirmation dialog shown at right will be displayed; press OK to display menu of print options. Choose page size, border, and time stamp options as described on preceding page (warning will be displayed if selected page size is too small). To start printing, highlight Start Printing and press OK . PictBridge menu will be displayed when printing is complete.

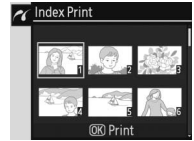

Printing Selected Photographs

Choosing **Print Select** displays the menu shown in Step 1.

1

Scroll through pictures. To display current picture full screen, press **MENU** button.

2

Select current picture and set number of prints to 1. Selected pictures marked by

3





Specify number of prints (up to 99). To deselect picture, press multi selector down when number of prints is 1. Repeat Steps 1 – 3 to select additional pictures.

4

Display print options. Choose page size, border, and time stamp options as described on page 71. To start printing, highlight **Start Printing** and press **OK**. PictBridge menu will be displayed when printing is complete.

Creating a DPOF Print Order: Print Set

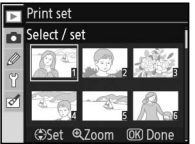
The **Print Set** option in the playback menu is used to create digital “print orders” for PictBridge-compatible printers and devices that support DPOF. Selecting **Print Set** from the playback menu displays the menu shown in Step 1.

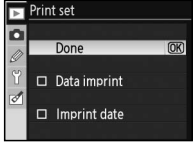
<p>1</p>   <p>Highlight Select / Set.</p>	<p>2</p>   <p>Display selection dialog.</p>
<p>3 Select pictures and specify number of prints as described in Steps 2 – 3 on previous page. Note that RAW (NEF) photos can not be selected for printing.</p>	
<p>4</p>   <p>Display options. Highlight option and press multi selector right:</p> <ul style="list-style-type: none">• Data imprint: Print shutter speed and aperture on all pictures in print order.• Imprint date: Print date of recording on all pictures in print order. <p>To complete print order and exit, highlight Done and press OK.</p>	

To print the current print order when the camera is connected to a PictBridge printer, select **Print (DPOF)** in the PictBridge menu and follow the steps in “Printing Selected Photographs” to modify and print the current order (72). DPOF date and data imprint options are not supported when printing via direct USB connection; to print the date of recording on photographs in the current print order, use the PictBridge **Time Stamp** option (71).

Print Set

The **Print Set** option can not be used if there is not enough space on the memory card to store the print order.

Print orders may not print correctly if images are deleted using a computer after the print order is created.

Menu Guide

Playback Options: The Playback Menu

The playback menu contains the following options (options displayed may differ if **My menu** is selected for the **CSM/Setup menu** option in the setup menu; 101). See “Using Camera Menus” (9) for more information on using the menus.

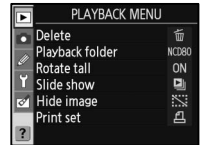

Option	Description	
Delete	Delete all or selected photos.	74
Playback folder	Choose folder for playback.	75
Rotate tall	Rotate “tall” (portrait-orientation) photos during playback.	75
Slide show	Play photos back in automatic slide shows, either with background music and panning, zoom, and transition effects (Pictmotion) or without (standard).	75
Hide image	Hide selected photos.	78
Print set	Select photos for printing.	78

Delete

The delete menu contains the following options:



Option	Description
Selected	Delete selected photographs (see below).
All	Delete all photographs.



Selecting Multiple Pictures



To select multiple pictures for deletion, slide shows, or the **Hide image** option:

1

Highlight picture. To view highlighted picture full frame, press button.

2







Select highlighted picture. Selection shown by icon.

3

Repeat steps 1–2 to select additional pictures. To deselect picture, highlight and press multi selector down.

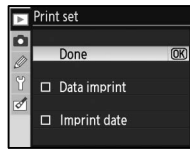
4

Complete operation.

Playback Folder

Choose a folder for playback:

Option	Description
Current	Only photos in the folder currently selected for Folders in the shooting menu are displayed during playback. This option is selected automatically when a photo is taken. If a memory card is inserted (default) and this option selected before photos have been taken, a message stating that the folder contains no images will be displayed during playback. Select All to begin playback.
All	Play back photos in all folders on the memory card.



Rotate Tall

Select **On** to rotate “tall” (portrait-orientation) photos for display in the monitor. Photographs taken with **Off** selected for **Auto image rotation** (Ⓜ 108) will be displayed in “wide” (landscape) orientation.

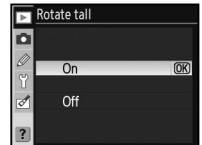

Slide Show

Play pictures back one after the other in an automated “slide show.” A **Pictmotion** option is available with transitions, panning and zoom effects and background music (background music will only be audible if the camera is connected to a television set; Ⓜ 66).

The recommended steps involved in creating a slide show are shown below.

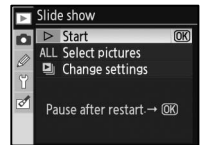

1 Select photos

Highlight **Select pictures** and press the multi selector right. Highlight one of the following options and press **OK** to select the highlighted option and return to the slide show menu.

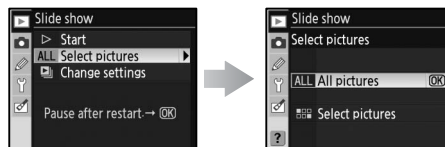

- All pictures**: Slide show will include all the photos in the current playback folder (Ⓜ 75).
- Select pictures**: Select up to fifty photos for the slide show (Ⓜ 74). Only photos in the current playback folder (Ⓜ 75) are available for selection; hidden photos and images that can not be displayed by the camera can not be selected.

2 Choose a style

Highlight **Change settings** and press the multi selector right, then highlight **Style** and press the multi selector right. Highlight one of the following options and press **OK** to select the highlighted option and return to the slide show menu.

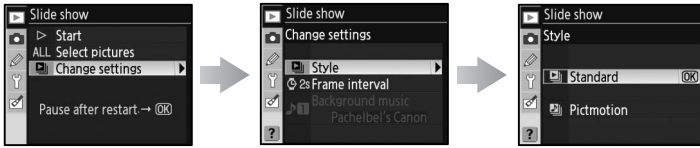

•**Standard:** Pictures are played back at a selected interval, without background music, transitions, or other effects.

•**Pictmotion:** Select a pattern that includes background music with matching transitions and zoom effects. Note that background music will only be audible if the camera is connected to a television (📺 66).

3 Choose a frame interval or playback pattern

Highlight **Change settings** and press the multi selector right, then choose a frame interval or playback pattern as described below.

“Standard” selected in Step 2

To change the interval between slides from the default setting of two seconds, highlight **Frame interval** and press the multi selector right. Highlight one of the following options and press **OK** to select the highlighted option and return to the slide show menu.

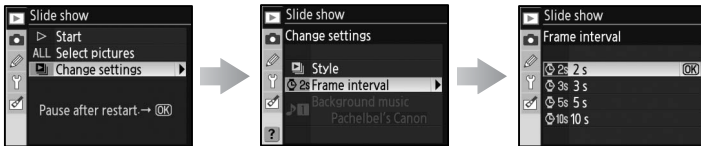

“Pictmotion” selected in Step 2

To change the background track from the default setting of **Pachelbel's Canon**, highlight **Background music** and press the multi selector right. Highlight one of the following options and press **OK** to select the highlighted option and return to the slide show menu.

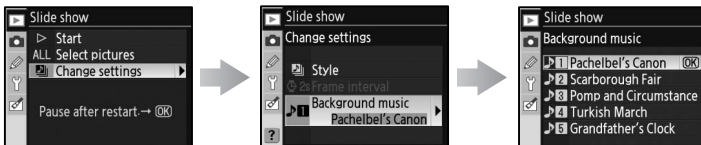







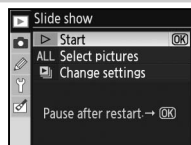

Panning and zoom effects and transitions are matched to the selected background track.

4 Start the show

To start the slide show, highlight **Start** and press **OK**. The following operations can be performed during a slide show:



To	Use	Description
Go forward or back one frame	 	Press multi selector or rotate main command dial left to return to the previous frame, right to skip to the next frame. This option is not available if Pictmotion is selected in Step 2.
View photo info	 	Change the photo info displayed. This option is not available if Pictmotion is selected in Step 2.
Pause slide show		Pause the slide show.
Exit to playback menu		End the slide show and return to the playback menu.
Exit to playback mode		End the slide show and return to full-frame ( 61) or thumbnail playback ( 63).
Exit to shooting mode	Shutter release	Press the shutter-release button halfway to turn the monitor off and return to shooting mode. Photos can be taken immediately.

The dialog shown at right is displayed when the show ends or when the **OK** button is pressed to pause playback. Select **Restart** to restart the show or **Exit** to return to the playback menu.

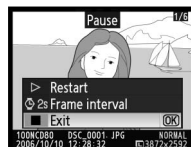

Hide Image

Hide or reveal selected photographs. Hidden images are visible only in the **Hide Image** menu, and can only be deleted by formatting the memory card.



Option	Description
Select/set	Hide or reveal selected photographs (74).
Deselect all?	Reveal all photographs.

File Attributes for Hidden Images

Hidden images have “hidden” and “read-only” status when viewed on a Windows computer. In the case of “NEF + JPEG” images, this marking applies to both NEF (RAW) and JPEG images.

Print Set

Choose **Select / set** to select photographs for printing on a PictBridge printer or DPOF-compatible device (73). Choose **Deselect all?** to remove all photos from the current print order.



Protected and Hidden Images

Revealing an image that is both hidden and protected will simultaneously remove protection from the image.

Shooting Options: The Shooting Menu

The shooting menu contains the following options (options displayed may differ if **My menu** is selected for the **CSM/Setup** option in the setup menu; 101). See “Using Camera Menus” (9) for more information on using the menus.

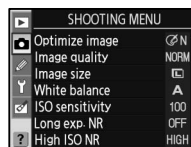

Option	Description	
Optimize image *	Optimize images according to scene.	79–81
Image quality †	Choose image quality.	81
Image size †	Choose image size.	81
White balance *,+	Adjust colors according to the light source.	82
ISO sensitivity †	Raise sensitivity when lighting is poor.	83
Long exp. NR	Reduce noise at slow shutter speeds.	83
High ISO NR	Reduce noise at high ISO sensitivities.	83
Multiple exposure *,+	Record multiple exposures in a single frame.	84–85

* Available in **P**, **S**, **A**, and **M** modes only.

† Reset to defaults when a two-button reset is performed (44).

Optimize Image (P, S, A, and M Modes)

Optimize contrast, sharpening, and other settings according to how photographs will be used or the type of scene.

Option	Description
Normal (default)	Recommended for most situations.
Softer	Softens outlines, producing natural results suitable for portraits or retouching on a computer.
Vivid	Enhances saturation, contrast, and sharpness to produce vivid images with vibrant reds, greens, and blues.
More vivid	Maximizes saturation, contrast, and sharpness to produce crisp images with sharp outlines.
Portrait	Lowers contrast while lending natural texture and rounded feel to skin of portrait subjects.
Custom	Customize image optimization settings (80).
Black-and-white	Take photos in black-and-white (81).

At Settings Other than “Custom”

At settings other than **Custom**:

- Photographs are optimized for current shooting conditions. Results will vary with exposure and the position of the subject in the frame.
- The sRGB color space is used. To use the Adobe RGB color space, select **Custom** and choose **II (Adobe RGB)** for **Color Mode**.
- Use a type G or D lens for best results.

Customizing Image Enhancement Options: Custom

Select **Custom** to make separate adjustments to the following options. After adjusting settings, highlight **Done** and press **OK**.

- **Image sharpening:** Choose how much outlines are sharpened during shooting. Choose high settings for sharp outlines, low settings for softer outlines.

Default setting: Auto.

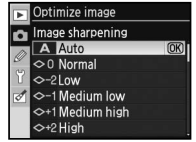

- **Tone compensation:** Control contrast. Lower settings prevent loss of detail in highlights under harsh lighting or in direct sunlight. Higher settings preserve detail in misty landscapes and other low-contrast subjects. Choose **Custom** to select a user-defined tone curve created using Camera Control Pro 2 or Camera Control Pro (both available separately;  123). See the software instruction manual for details.

Default setting: Auto.

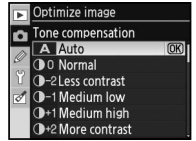

- **Color mode:** Control color reproduction. Photos taken in modes Ia and IIIa are adapted to the sRGB color space and are suited for printing or use “as is,” with no further modification. Choose Ia for portrait shots and IIIa for nature or landscape shots. Mode II is adapted to the Adobe RGB color space, which supports a wider gamut of colors than sRGB. Mode II is the preferred choice for photos that will be extensively processed or retouched.

Default setting: Ia (sRGB).

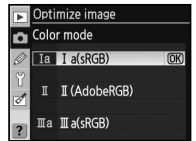

- **Saturation:** Control the vividness of colors. Choose **Moderate** for less saturated colors, **Enhanced** for more vivid colors.

Default setting: Auto.

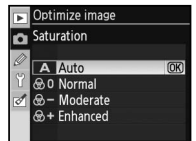

- **Hue adjustment:** Hue can be adjusted between -9° to $+9^\circ$ in increments of 3° (the degrees refer to the “color wheel” often used to express hue). Positive values make reds more orange, greens more blue, and blues more purple. Negative values make reds more purple, blues more green, and greens more yellow.

Default setting: ± 0 .

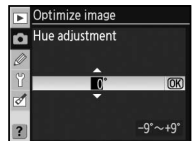

“Auto”

Results for auto image sharpening, tone compensation, and saturation vary with exposure and the position of the subject in the frame. Use a type G or D lens for best results.

Color Mode

Modes Ia and IIIa are recommended for photos that will be printed without modification or viewed in applications that do not support color management. If the application supports color management, choose the Adobe RGB color space when opening photos taken in mode II. ViewNX (supplied) and Capture NX (available separately;  123) display colors correctly even if the correct color space is not selected.

Taking Pictures in Black-and-White: Black-and-White

Selecting **Black-and-white** for **Optimize image** displays the menu shown at right. Choose **Normal** to take standard black-and-white pictures, or **Custom** to adjust sharpening and tone compensation before shooting as described in on page 80. **Custom** also supports the following color filter effects:

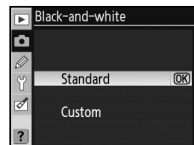

Filter effect	Description
Off	No color filter effect.
Yellow	Enhances contrast. Can be used to tone down the brightness of the sky in landscape photographs.
Orange	Orange produces more contrast than yellow, red more contrast than orange.
Red	
Green	Softens skin tones. Can be used for portraits.

Black-and-white indicators appear in the control panel and viewfinder when **Black-and-white** is selected for **Optimize image** (Ⓝ 5–7).

Image Quality (All Modes)

Seven options are available for image quality. See “Reference: Image Quality and Size” (Ⓝ 33).

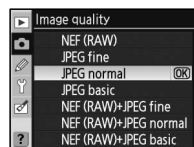
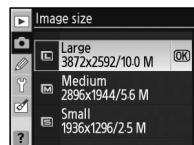

Image Size (All Modes)

Image size can be selected from **Large**, **Medium**, and **Small**. See “Reference: Image Quality and Size” (Ⓝ 33).



White Balance (P, S, A, and M Modes)

Nine options are available for white balance. See “Reference: White Balance” (p. 58).

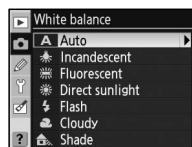

Copying White Balance from a Photograph

A white balance value copied from an existing photograph can be used for preset white balance. Select **White balance > White balance preset** in the shooting menu. The menu shown in Step 1 will be displayed.

1	<p>Highlight Use photo.[*]</p>	2	<p>Display current source photo.</p>
----------	--	----------	--------------------------------------

* To use last measured value (p. 60), highlight **Measure** and press multi selector right.

3	<p>Highlight Select image.[†]</p>	4	<p>Display folder list.</p>
----------	---	----------	-----------------------------

† To use the previous source photo, highlight **This image** and press multi selector right.

5	<p>Highlight folder.</p>	6	<p>Display images in selected folder.</p>
----------	--------------------------	----------	---

7	<p>Highlight photograph.[‡]</p>	8	<p>Set preset white balance to value for highlighted photograph and return to shooting menu.</p>
----------	--	----------	--

‡ Images displayed may include those created with other cameras, but only photographs created with D80 can be used as source for preset white balance.

Note that if a new value is measured for white balance, white balance will be set to the measured value even if **Use photo** is currently selected in the preset white balance menu.

ISO Sensitivity (All Modes)

Adjust ISO sensitivity. See “Reference: ISO Sensitivity” (43).

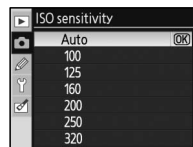

Long Exp. NR (All Modes)

Photographs taken at shutter speeds slower than 8 s can be processed to reduce “noise” in the form of randomly-spaced, brightly-colored pixels. Choose from the following options:

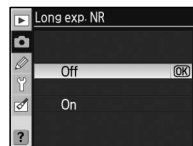

Option	Description
Off (default)	Noise reduction off.
On	Photographs taken at shutter speeds slower than 8 s are processed to reduce noise, slowing burst shooting and reducing the number of images that can be stored in the memory buffer. During processing, the displays shown at right appear in the control panel and viewfinder. No further photos can be taken until processing is complete. Noise reduction will not be performed if the camera is turned off during processing. Note that if photos are played back during processing, the image displayed in the monitor may not show the effects of noise reduction.



High ISO NR (All Modes)

Photographs taken at high sensitivities can be processed to reduce “noise”. Choose from the following options:

Option	Description
Normal (default)	Noise reduction takes effect at sensitivities over ISO 400. Choose
Low	Low for less noise reduction, High for more noise reduction.
High	
Off	Noise reduction turns off unless sensitivity exceeds ISO 800. Minimal noise reduction is performed at sensitivities over ISO 800.



Multiple Exposure (P, S, A, and M Modes)

Follow the steps below to record a series of two or three exposures in a single photograph. Note that at default settings, shooting will end automatically if no operations are performed for 30 s. For an interval between exposures of more than 30 s, choose **30 min** for Custom Setting 28 (**Auto meter-off**;  99) or use an optional EH-5/EH-5a AC adapter.



- 1** Selecting **Multiple exposure** in the shooting menu displays the menu shown at right. Highlight **Number of shots** and press the multi selector right.

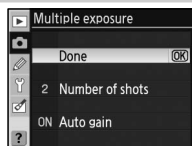

- 2** Press the multi selector up or down to choose the number of exposures that will be combined to form a single photograph. Press **OK** to return to the multiple exposure menu.

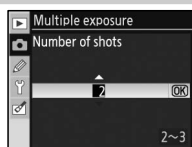

- 3** Highlight **Auto gain** and press the multi selector to the right.

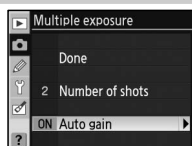

- 4** Highlight one of the following options and press **OK**.

Option	Description
On (default)	Gain adjusted to correct exposure according to the number of exposures recorded (gain for each exposure is set to $\frac{1}{2}$ for two exposures, $\frac{1}{3}$ for three exposures).
Off	Gain not adjusted to correct exposure. Recommended if background is dark.

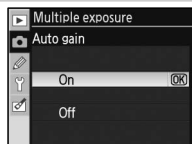

Exchanging Memory Cards

Do not remove or replace the memory card while recording a multiple exposure.

Photo Info

The date of recording, metering, exposure, mode, focal length, camera orientation, and other information listed in the playback photo information display is for the first shot in the multiple exposure.

5 Highlight **Done** and press **OK**.

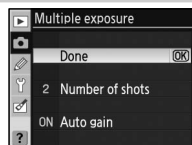

A  icon will be displayed in the control panel. To exit without recording a multiple exposure, select **Multiple exposure** from the shooting menu, highlight **Reset**, and press **OK**.

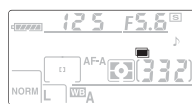

6 Frame a photograph, focus, and shoot. The  icon will start to blink.





Cancelling a Multiple Exposure

To end shooting before the multiple exposure is complete, select **Multiple exposure** from the shooting menu, highlight **Cancel**, and press **OK**. Shooting will also end if:

- The exposure meters turn off during shooting ( 18)
- The user performs a two-button reset
- The camera is turned off
- The battery is exhausted
- The multiple exposure is deleted
- A mode other than **P**, **S**, **A**, or **M** is selected

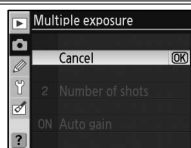
If shooting ends before the specified number of exposures have been taken, a multiple exposure will be created from the exposures that have been recorded to that point. If **Auto gain** is on, gain will be adjusted to reflect the number of exposures actually recorded.



7 Take the remaining exposures. The  icon will disappear from the control panel when shooting is complete. Repeat steps 1–7 to take additional multiple exposures.



Bracketing and Other Settings

Bracketing is cancelled when multiple exposure is selected and can not be restored until shooting has ended. While multiple exposure mode is in effect, memory cards can not be formatted and no shooting menu options can be changed, with the exceptions of **Multiple exposure** and **White balance**.

Custom Settings

Custom Settings are used to customize camera settings to suit individual preferences. The following options are available when **Simple** (the default option) is selected for **CSM/Setup menu** in the setup menu (📷 101):

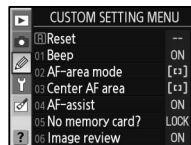

Option	📷
R Reset	86
1 Beep	86
2 AF-area mode	87
3 Center AF area	87
4 AF-assist	87
5 No memory card?	88

Option	📷
6 Image review	88
7 ISO auto	88
8 Grid display	89
9 Viewfinder warning	89
10 EV step	89

To display the following options, select **Full** for **CSM/Setup menu**:

Option	📷
11 Exposure comp.	89
12 Center-weighted	90
13 Auto BKT set	90–91
14 Auto BKT order	91
15 Command dials	91
16 FUNC button	92–93
17 Illumination	93
18 AE-L/AF-L	94
19 AE lock	94
20 Focus area	94
21 AF area illumination	95

Option	📷
22 Built-in flash	95–97
23 Flash warning	98
24 Flash shutter speed	98
25 Auto FP	98
26 Modeling flash	98
27 Monitor-off	98
28 Auto meter-off	99
29 Self-timer	99
30 Remote on duration	99
31 Exp. delay mode	99
32 MB-D80 batteries	100

R: Reset

Select **Reset** to restore all Custom Settings to their default values, including settings not affected by a two-button reset (📷 44). See the Appendix (📷 134) for a complete list of default settings.



1: Beep (All Modes)



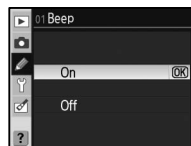



At the default setting of **On**, a beep will sound when the camera focuses in single-servo AF (**AF-S** or when shooting stationary subjects in **AF-A** autofocus mode), while the release timer is counting down in self-timer and delayed remote modes (📷 37, 38), or when a photograph is taken in quick-response remote mode (📷 38). The beep will not sound when **Off** is selected. The current setting is shown in the control panel: ♪ is displayed when the beep is on, 🤦 when it is off (📷 5).



2: AF-Area Mode (All Modes)

This option determines how the focus area is selected in autofocus mode (28). Choose from:





Option	Description
[C] Single area	User selects focus area using multi selector; camera focuses on subject in selected focus area only. Use with stationary subjects. Default setting for P, S, A, M, and  modes.
[C] Dynamic area	User selects focus area manually, but if subject leaves selected focus area even briefly, camera will focus based on information from other focus areas. Use with erratically moving subjects. Default setting for  mode.
[M] Auto-area AF	Camera selects focus area automatically. Default for  ,  ,  ,  , and  modes.

The current setting is shown by an icon in the control panel (5).

3: Center AF Area (All Modes)

This option determines the size of the center focus area.

Option	Description	Viewfinder display
Normal zone (default)	Focus on a specific subject in a small area without other nearby objects interfering with focus.	
Wide zone	Focus on moving subjects and other objects that are difficult to track. Not available when Auto-area AF is selected for Custom Setting 2 (AF-area mode).	

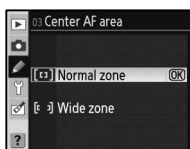

See “Focus” for more information on focus settings (28).

4: AF-Assist (All Modes Except , , and)

If **On** (the default setting) is selected and the subject is poorly lit, the AF-assist illuminator will light to assist the focus operation in single-servo AF (**AF-S** or single-servo AF selected in **AF-A** autofocus mode) when **Single area** or **Auto-area AF** is selected for Custom Setting 2 (**AF-area mode**) or when Custom Setting 2 is set to **Dynamic area** and the center focus area is selected. Choose **Off** to disable the AF-assist illuminator. Note that when the illuminator is off, the camera may not be able to focus on poorly-lit subjects using autofocus.



5: No Memory Card? (All Modes)

If **Release locked** (the default setting) is selected, the shutter-release is disabled when no memory card is inserted. Choose **Enable release** to enable the shutter-release button when no memory card is inserted. Photographs will be displayed in the monitor but will not be saved.

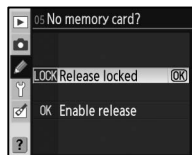



6: Image Review (All Modes)

If **On** (the default setting) is selected, photographs will automatically be displayed in the monitor for about four seconds after shooting. If **Off** is selected, photographs can be displayed in the monitor by pressing the  button.



7: ISO Auto (P, S, A, and M Modes Only)

If **Off** (the default setting) is selected, ISO sensitivity will remain fixed at the value selected with the **ISO** button ( 43) or using the **ISO sensitivity** option in the shooting menu ( 83).



If **On** is selected, ISO sensitivity will automatically be adjusted if optimal exposure can not be achieved at the selected value (flash level is adjusted appropriately). The maximum value for auto ISO sensitivity can be selected using the **Max. sensitivity** option. In modes **P** and **A**, sensitivity will only be adjusted if underexposure would result at the shutter speed selected for **Min. shutter speed**.

When **On** is selected, the control panel and viewfinder show **ISO-AUTO**. When sensitivity is altered from the value selected by the user, these indicators blink and the altered value is shown in the viewfinder (the indicators do not blink if a flash is used).

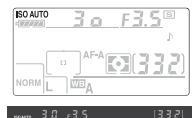

ISO Auto

Auto ISO control is not available when a value over ISO 1600 is selected for ISO sensitivity. ISO sensitivity can not be set to values over 1600 when **On** is selected for **ISO auto**. Foreground subjects may be underexposed in photos taken with the flash at slow shutter speeds, in daylight, or against a bright background. Choose a flash mode other than slow sync or select mode **A** or **M** and choose a larger aperture.

Noise is more likely at higher sensitivities. Use the **High ISO NR** option in the shooting menu to reduce noise ( 83).

8: Grid Display (All Modes)

Select **On** to display grid lines in the viewfinder to assist in framing photographs (6). The default option is **Off**.

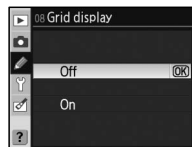

9: Viewfinder Warning (All Modes)

Select **On** (the default option) to display the following warnings in the viewfinder (6):

Warning	Description
B/W	Displayed when Black-and-white is selected for Optimize image in the shooting menu (81).
	Displayed when the battery is low.
	Displayed when no memory card is inserted.



No warnings are displayed when **Off** is selected.

10: EV Step (All Modes)

Choose whether adjustments to shutter speed, aperture, and bracketing are made in increments equivalent to $\frac{1}{3}$ EV (**1/3 step**, the default option) or $\frac{1}{2}$ EV (**1/2 step**).



11: Exposure Comp. (P, S, A, and M Modes Only)

If **Off** (the default option) is selected, exposure compensation is set by pressing the  button and rotating the main command dial (54). Select **On** to set exposure compensation using only a command dial. The dial used depends on the option selected for Custom Setting 15 (**Command dials**; 91):

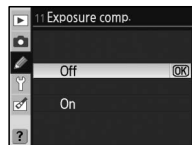

	Custom Setting 15 (Command dials): Off	Custom Setting 15 (Command dials): On
P	Sub-command dial	Sub-command dial
S	Sub-command dial	Main command dial
A	Main command dial	Sub-command dial
M	Exposure compensation set by pressing  button and rotating main command dial	

If **On** is selected, the 0 at the center of the exposure display will blink even when exposure compensation is set to ± 0 . This option is not available in mode **M**.

12: Center-Weighted (P, S, A, and M Modes Only)

This option controls the size of the area in the center of the viewfinder assigned the greatest weight in center-weighted metering. The default option is $\Phi 8$ mm.



13: Auto BKT Set (P, S, A, and M Modes Only)

The following options are available:

Option	Description
AE & flash (default)	Camera varies flash level and exposure with each shot.
AE only	Camera varies exposure with each shot.
Flash only	Camera varies flash level with each shot (i-TTL and, with the optional SB-800 Speedlight, auto aperture modes only; 119, 120).

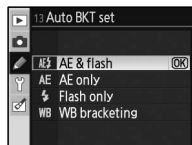

WB bracketing

Each time the shutter is released, the camera creates multiple images “bracketing” the current white balance setting. Only one shot is required to complete the bracketing sequence. White balance bracketing is recommended when shooting under mixed lighting or experimenting with different white balance settings. Not available at a white-balance of (Choose color temp.) or at image qualities of **NEF (RAW)**, **NEF+JPEG Fine**, **NEF+JPEG Normal**, or **NEF+JPEG Basic**.

For information on recording photographs at settings of **AE & flash**, **AE only**, and **Flash only**, see “Bracketing” (56). To take photographs using white balance bracketing:

- 1 Highlight **WB bracketing** and press the multi selector right.



- 2 Press the button and rotate the main command dial to choose the number of images in the bracketing sequence.

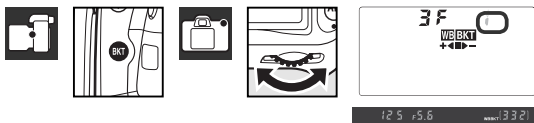

- 3 Press the button and rotate the sub-command dial to choose the white balance adjustment. Each increment is roughly equivalent to 10 mired.



4 Compose a photograph, focus, and shoot. Each shot will be processed to create the number of copies specified in the bracketing program, and each copy will have a different white balance. Modifications to white balance are added to the white balance adjustment made with white balance fine-tuning.

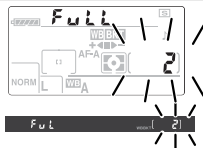

If the number of images in the bracketing program exceeds the number of exposures remaining, **FULL (FUL)** will be displayed and the number of exposures remaining will blink. Shooting can begin if a new memory card is inserted.

To cancel bracketing, press the **BKT** button and rotate the main command dial until the number of shots in the bracketing sequence is zero and **WB BKT** is no longer displayed in the control panel. The program last in effect will be restored the next time bracketing is activated. Bracketing can also be cancelled by performing a two-button reset (44), although in this case the bracketing program will not be restored the next time bracketing is activated.



14: Auto BKT Order (P, S, A, and M Modes Only)

Choose the order in which bracketing is performed.

Option	Description
Default order (default)	Unmodified > negative > positive (356).
Under > MTR > over	Negative > unmodified > positive (356, 140).

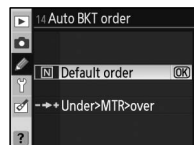

15: Command Dials (P, S, A, and M Modes Only)

Choose the command dials used to set shutter speed and aperture.

Option	Description
Default (default)	The main command dial controls shutter speed, the sub-command dial aperture.
Reversed	The main command dial controls aperture, the sub-command dial shutter speed.



White Balance Bracketing

Selecting **NEF (RAW)**, **NEF+JPEG Fine**, **NEF+JPEG Normal**, or **NEF+JPEG Basic** for image quality (34) or **(Choose color temp.)** for white balance (58) cancels white balance bracketing.

Bracketing Programs

See the Appendix for a list of white balance bracketing programs.

16: FUNC Button (All Modes)

Choose the function performed by the FUNC. button.

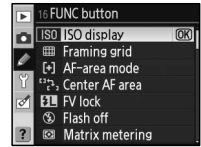

Option	Description
ISO display (default)	The modified value for ISO sensitivity is displayed while the FUNC. button is pressed.
Framing grid	Press the FUNC. button and rotate the main command dial to turn the grid display in the viewfinder on and off (89).
AF-area mode	Press the FUNC. button and rotate the main command dial to select AF area mode (87).
Center AF area	Press the FUNC. button and rotate the main command dial to choose between normal and wide center AF areas (87).
FV lock	If the built-in flash or an optional SB-800, SB-600, SB-400, or SB-R200 flash unit is used, flash value locks when the FUNC. button is pressed (93). Press again to cancel FV lock.
Flash off	Built-in flash and optional Speedlights turn off while the FUNC. button is pressed.
Matrix metering	Matrix metering is activated while the FUNC. button is pressed (P , S , A , and M modes only).
Center-weighted	Center-weighted metering is activated while the FUNC. button is pressed (P , S , A , and M modes only).
Spot metering	Spot metering is activated while the FUNC. button is pressed (P , S , A , and M modes only).

FV Lock

This feature is used to lock flash output, preventing the flash level from changing between shots or while recomposing photographs. Flash output is adjusted automatically for any changes in ISO sensitivity or aperture.

FV Lock

Both the FUNC. and the **AE-L/AF-L** button can be used for FV lock. FV lock using the FUNC. button is described below; to use the **AE-L/AF-L** button, choose **FV lock** for Custom Setting 18 (**AE-L/AF-L**; 94).

- 1 Select **FV lock** for Custom Setting 16 (**FUNC button**).



- 2 Raise the flash. In **AUTO**, **S&L**, **AF-ON**, and **AF-ON** modes, the flash will pop up automatically as required when the shutter-release button is pressed halfway. In **P**, **S**, **A**, and **M** modes, press the **ⓘ** button to raise the flash.

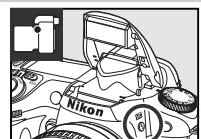

- 3** Position the subject in the center of the frame and press the shutter-release button halfway to focus. Check that the flash-ready indicator (⚡) is displayed in the viewfinder.



- 4** Press the FUNC. button. The flash will emit a monitor preflash to determine the appropriate flash level. Flash output will be locked at this level and a flash-value lock icon will appear in the viewfinder.

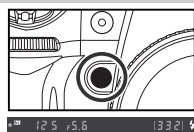

- 5** Recompose the photograph.



- 6** Press the shutter-release button the rest of the way down to shoot. If desired, additional pictures can be taken without releasing FV lock.



- 7** Press the FUNC. button to release FV lock and confirm that the  icon is no longer displayed in viewfinder.



17: Illumination (All Modes)

If **Off** (the default option) is selected, the control panel backlight (LCD illuminator) will turn on only when the power switch is rotated to . If **On** is selected, the backlight will remain on while the exposure meters are active (note that this will increase the drain on the battery).

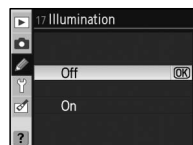

Using FV Lock with Optional Speedlights

FV lock is also available with SB-800, SB-600, SB-400 and SB-R200 Speedlights (available separately). Set the Speedlight to TTL mode (the SB-800 can also be used in AA mode; see the Speedlight manual for details). While FV lock is in effect, flash output will automatically be adjusted for changes in Speedlight zoom head position.

When **Commander mode** is selected for Custom Setting 22 (**Built-in flash**;  96), FV lock can be used with remote SB-800, SB-600, or SB-R200 flash units if (a) any of the built-in flash, flash group A, or flash group B is in TTL mode, or (b) a flash group is composed entirely of SB-800 Speedlights in TTL or AA mode.

Using FV Lock with the Built-in Flash

When the built-in flash is used alone, FV lock is only available if **TTL** (the default setting) is selected for Custom Setting 22 (**Built-in flash**;  95).

18: AE-L/AF-L (All Modes)

Choose the function performed by the **AE-L/AF-L** button.

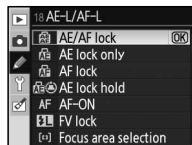

Option	Description
AE/AF lock (default)	Both focus and exposure lock while the AE-L/AF-L button is pressed.
AE lock only	Exposure locks while the AE-L/AF-L button is pressed. Focus is unaffected.
AF lock	Focus locks while the AE-L/AF-L button is pressed. Exposure is unaffected.
AE lock hold	Exposure locks when the AE-L/AF-L button is pressed and remains locked until the button is pressed again or the exposure meters turn off.
AF-ON	The AE-L/AF-L button initiates autofocus. The shutter-release button can not be used to focus.
FV lock	If the built-in flash or an optional SB-800, SB-600, or SB-R200 flash unit is used, flash value locks when the AE-L/AF-L button is pressed (92). Press again to cancel FV lock.
Focus area selection	Press the AE-L/AF-L button and rotate the sub-command dial to select the focus area (30).
AE-L/AF-L/AF area	Press the AE-L/AF-L button to lock focus and exposure, press and rotate the sub-command dial to select the focus area.
AE-L/AF area	Press the AE-L/AF-L button to lock exposure, press and rotate the sub-command dial to select the focus area.
AF-L/AF area	Press the AE-L/AF-L button to lock focus, press and rotate the sub-command dial to select the focus area.
AF-ON/AF area	Press the AE-L/AF-L button to initiate autofocus, press and rotate the sub-command dial to select the focus area.

19: AE Lock (All Modes)

If **Off** (the default option) is selected, pressing the shutter-release button halfway does not lock exposure. If **On** is selected, exposure will lock when the shutter-release button is pressed halfway.



20: Focus Area (All Modes)

At the default setting of **No wrap**, the focus-area display is bounded by the outer focus areas so that, for example, pressing the multi-selector up when the focus area is selected has no effect. Select **Wrap** to allow focus-area selection to “wrap around” from top to bottom, bottom to top, right to left, and left to right.

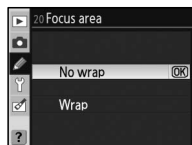

21: AF Area Illumination (All Modes)

At the default setting of **Auto**, the active focus area is highlighted in the viewfinder as need to establish contrast with the background. If **Off** is selected, the focus area is not highlighted. If **On** is selected, the focus area will always be highlighted, although it may be difficult to see against the background.

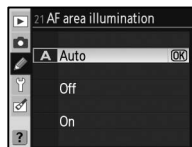

22: Built-in Flash (P, S, A, and M Modes Only)

Choose a flash control mode for the built-in flash.

TTL (default): Flash output is adjusted automatically in response to shooting conditions.



Manual: The flash fires at the level selected in the menu shown at right. At full power, the built-in flash has a Guide Number of 13/42 (m/ft., ISO 100, 20 °C/68 °F). No monitor preflash is emitted.

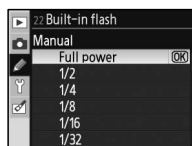

Repeating flash: The flash fires repeatedly while the shutter is open, producing a strobe-light effect. Selecting this option displays the menu shown at right. Press the multi selector left or right to highlight the following options, up or down to change.



Option	Description
Output	Choose flash output (expressed as a fraction of full power).
Times	Choose the number of times the flash fires at the selected output. The options available depend on the option selected for Output .
Freq.	The number of times the flash fires per second.

“Times”

The number of times the flash can fire in succession is determined by flash output. Note that depending on shutter speed and the option selected for **Freq.**, the actual number of flashes emitted may be less than selected.

Options available for “Times”	
1/4	2
1/8	2–5
1/16	2–10
1/32	2–10, 15
1/64	2–10, 15, 20, 25
1/128	2–10, 15, 20, 25, 30, 35

Commander mode: Use the built-in flash as a master flash controlling one or more remote optional SB-800, SB-600, or SB-R200 flash units in up to two groups (A and B) using advanced wireless lighting. Selecting this option displays the menu shown at right. Press the multi selector up or down to highlight the following options, up or down to change.

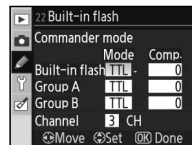

- **Built-in flash:** Choose a flash control mode for the built in flash.

TTL	i-TTL mode. Choose a flash compensation (Comp.) value between +3.0 and -3.0 EV in steps of 1/3 EV. At settings other than ±0, 1/3 will be displayed in the control panel and viewfinder.
M	Choose from output levels between 1/1 (full power) and 1/128 (1/128 of full power). 1/32 flashes in the control panel and viewfinder.
--	Built-in flash does not fire, but AF-assist illuminator lights. 1/32 does not appear in control panel flash mode display. Note that the built-in flash must be raised to emit monitor preflashes.

- **Group A/Group B:** Choose a flash control mode for all flash units in Group A or B.

TTL	i-TTL mode. Choose a Comp. value between +3.0 and -3.0 EV in steps of 1/3 EV.
AA	Auto aperture. Choose a flash compensation (Comp.) value between +3.0 and -3.0 EV in steps of 1/3 EV. SB-600 and SB-R200 flash units will not fire when this option is selected.
M	Choose from output levels between 1/1 (full power) and 1/128 (1/128 of full power).
--	The flash units in the selected group do not fire.

- **Channel:** Choose from channels 1-4. All flash units in both groups must be set to the same channel.

To take photographs in commander mode:

- 1 Choose the flash control mode and output level for the built-in flash. Note that output level can not be adjusted when -- is selected for flash control mode.

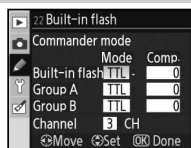

- 2 Choose the flash control mode and output level for the flash units in group A.

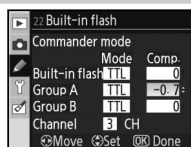

- 3 Choose the flash control mode and output level for the flash units in group B.

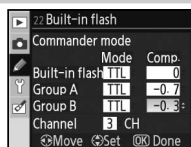

- 4 Select the channel.



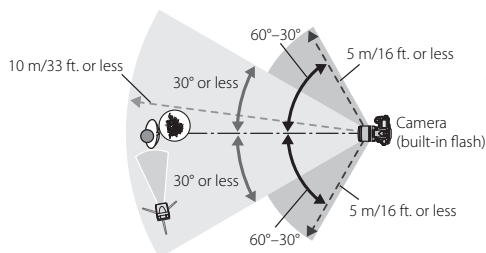

5 Press **OK**.

6 Compose the shot and arrange the flash units as shown below. Note that the maximum distance at which the remote flash units can be placed may vary with shooting conditions.



Wireless remote sensors on flash units should face camera.

7 Turn all the remote flash units on and set them to the channel selected in Step 4. See the Speedlight instruction manuals for details.

8 Press the  button to raise the built-in flash. Note that even if  is selected for **Built-in flash > Mode**, the built-in flash must be raised so that monitor preflashes will be emitted.

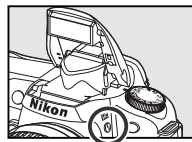

9 Focus and shoot after confirming that the flash-ready lights on the camera and all remote flash units are lit.

Commander Mode

Position the sensor windows on the remote flash units to pick up the monitor preflashes from the built-in flash (particular care is required when not using a tripod). Be sure that direct light or strong reflections from the remote flash units do not enter the camera lens (in TTL mode) or the photocells on the remote flash units (AA mode), as this may interfere with exposure. To prevent timing flashes emitted by the built-in flash from appearing in photographs taken at short range, choose low ISO sensitivities and small apertures (large f-numbers) or use an optional SG-3IR infrared panel for the built-in flash. An SG-3IR is required for best results with rear-curtain sync, which produces brighter timing flashes. After positioning the remote flash units, take a test shot and view the results in the camera monitor.

Although there is no limit on the number of remote flash units that may be used, the practical maximum is three. With more than this number, the light emitted by the remote flash units will interfere with performance.

Flash compensation ( 55) is added to the flash output for all flash units, including the built-in flash.

23: Flash Warning (P, S, A, and M Modes Only)

If **On** (the default setting) is selected and lighting is poor, the flash-ready light (⚡) will flicker in the viewfinder when the shutter-release button is pressed halfway to warn that the built-in flash is required. No warning will be displayed if **Off** is selected.



24: Flash Shutter Speed (P, S, A, and M Modes Only)

Choose the slowest shutter speed at which the flash will be used in modes **P** and **A** (the default setting is **1/60 s**). Regardless of the setting chosen, the flash will fire at shutter speeds as slow as 30 s when set to slow sync (Ⓜ 41).



25: Auto FP (P, S, A, and M Modes Only)

Select **On** to activate Auto FP High-Speed Sync when using the optional SB-800, SB-600, or SB-R200 flash units at shutter speeds faster than $\frac{1}{2000}$ s (because the actual shutter speed may be slightly slower than displayed in P and A modes, Auto FP may not always be activated at a shutter speed of $\frac{1}{2000}$ s). Choose to enable fill flash when taking portraits under bright light or when taking photographs at Large apertures. Auto FP High-Speed Sync is not available when using the built-in flash. The default setting is **Off**.



26: Modeling Flash (P, S, A, and M Modes Only)

If **On** is selected, the built-in flash and optional SB-800, SB-600, and SB-R200 flash units will emit a modeling flash when the camera depth-of-field preview button is pressed (Ⓜ 49). The default setting is **Off**.

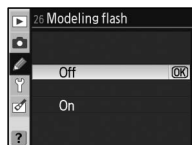

27: Monitor-Off (All Modes)

Choose how long the monitor remains on when no operations are performed (the default setting is 20 s). Choose a shorter monitor-off delay for longer battery life. Regardless of the setting chosen, the monitor remains on for four seconds during image review (Ⓜ 88) and for ten minutes when the camera is powered by an optional EH-5/EH-5a AC adapter.



28: Auto Meter-Off (All Modes)

Choose how long the camera continues to meter exposure when no operations are performed (the default setting is 6 s). Choose a shorter meter-off delay for longer battery life. Regardless of the setting chosen, the exposure meters remain on for ten minutes when the camera is powered by an optional EH-5/EH-5a AC adapter.

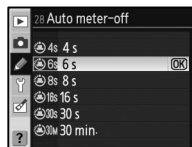

29: Self-Timer (All Modes)

Choose the length of the shutter-release delay in self-timer mode (37). The default setting is 10 s.



30: Remote On Duration (All Modes)

Choose how long the camera will wait for a signal from the remote before cancelling delayed or quick-response remote modes (38). Choose shorter times for longer battery life. The default setting is one minute.



31: Exp. Delay Mode (All Modes)

Select **On** to delay shutter release until about 0.4 s after the shutter-release button is pressed, reducing camera shake in situations in which the least camera movement could result in blurred photographs (for example, microscope photography). The default option is **Off**.

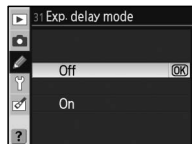

32: MB-D80 Batteries (All Modes)



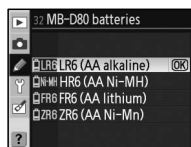

To ensure that the camera functions as expected when AA batteries are used in the optional MB-D80 battery pack, match the option selected in this menu to the type of batteries inserted in the battery pack. There is no need to adjust this option when using EN-EL3e batteries.



Option	Description
LR6 (AA alkaline) (default)	Select when using LR6 alkaline AA batteries.
HR6 (AA Ni-MH)	Select when using HR6 NiMH AA batteries.
FR6 (AA lithium)	Select when using FR6 lithium AA batteries.
ZR6 (AA Ni-Mn)	Select when using ZR6 nickel-manganese AA batteries.

Using AA Batteries

EN-EL3e batteries are recommended for best performance. Fewer pictures can be taken with AA batteries than with EN-EL3e batteries. The capacity of AA batteries drops sharply at temperatures below 20 °C (68 °F) and varies with make and storage conditions; in some cases, batteries may cease to function before their expiry date. Some AA batteries can not be used; due to their performance characteristics and limited capacity, alkaline and nickel-manganese batteries should only be used when no other alternative is available. The camera shows the level of AA batteries as follows:

Control panel	Viewfinder	Description
	–	Batteries fully charged.
		Low battery. Ready fresh batteries.
 (blinks)	 (blinks)	Shutter release disabled. Insert fresh batteries.

Basic Camera Settings: The Setup Menu

The setup menu contains the options listed below (options displayed may differ if **My Menu** is selected for **CSM/Setup menu**). See “Using Camera Menus” (🔧 9) for more information on using the menus.



The following options are available when **Simple** (the default option) is selected for **CSM/Setup menu**:

Option	🔧
CSM/Setup menu	101–102
Format memory card	102
World time	103
LCD brightness	103
Video mode	103
Language	103
USB	104

To display the following options, select **Full** for **CSM/Setup menu**:

Option	🔧
Image comment	104
Folders	105
File no. sequence	106
Mirror lock-up *	106
Dust off ref photo	106–107
Battery info	107
Firmware version	108
Auto image rotation	108

* Not available at battery levels of or below or when camera is powered by optional MB-D80 battery pack with AA batteries.

CSM / Setup Menu

Choose the options displayed in the menus.

Option	Description
Simple (default)	Display only basic options in the Custom Settings (🔧 86) and setup menus (see above). Other menu list all options.
Full	Display all options in all menus.
My menu	Display only selected options in the playback, shooting, Custom Settings, setup, and retouch menus.

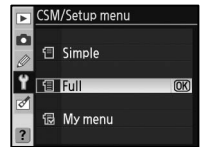

To choose menu items for display with **My menu**:

1 Highlight **My menu** and press the multi selector right. A list of menu names will be displayed.

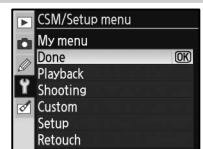

2 Highlight a menu name and press **OK**. The items in the selected menu will be listed as shown at right (the illustration shows the items listed when the playback menu is selected). The **CSM / Setup menu** item in the setup menu can not be selected.

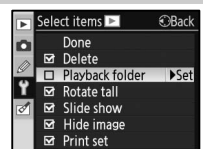

- 3** Press the multi selector up or down to highlight items and then press to the right to select or deselect. Selected items are indicated by a check mark.



- 4** Highlight **Done** and press **OK** to return to the list of menu names shown in Step 1. Repeat steps 2–3 to edit additional menus.



- 5** Highlight **Done** in the list of menu names and press **OK** to return setup menu.



Format Memory Card

Select **Yes** to format the memory card. Note that this permanently deletes all photographs and any other data the card may contain. Be sure that any valued files have been copied to a computer before formatting.

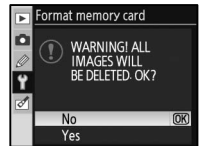

Formatting Memory Cards

Do not turn the camera off or remove the memory card while formatting is in progress.

Two-Button Format

Memory cards can also be formatted with the **FORMAT** () and () buttons ( 44).

World Time

Set the camera clock to the current date and time.

Option	Description
Time zone	Choose the time zone. The camera clock will automatically be reset to the time in the selected zone.
Date	Set the camera clock (🕒 14). Reset the clock regularly for accurate time keeping.
Date format	Choose the order in which the month, day, and year are displayed.
Daylight saving time	Turn daylight saving time on or off. The camera clock is automatically advanced or set back one hour.

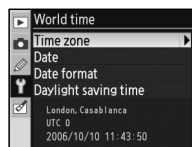

LCD Brightness

Adjust monitor brightness between -2 (darkest) and +2 (brightest).



Video Mode

Choose **NTSC** when connecting the camera to an NTSC television or VCR. Choose **PAL** when connecting the camera to a PAL video device.

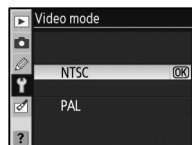

Language

Choose the language for camera menus and messages from:

De Deutsch	German	Pt Português	Portuguese
En English	English	Ru Русский	Russian
Es Español	Spanish	Sv Svenska	Swedish
Fi Suomi	Finnish	繁 中文 (繁體)	Traditional Chinese
Fr Français	French	簡 中文 (简体)	Simplified Chinese
It Italiano	Italian	日 日本語	Japanese
Nl Nederlands	Dutch	한 한글	Korean
Pl Polski	Polish		



The Clock Battery

The camera clock is powered by an independent, rechargeable power source, which is charged as necessary when the main battery is installed or the camera is powered by an optional EH-5/ EH-5a AC adapter. Two days of charging will power the clock for about one month. If **CLOCK** flashes in the control panel, the clock battery is exhausted and the clock has been reset to a time starting at 2006.01.01.00:00:00. Set the clock to the correct date and time.

USB

Choose a USB option for connection to a computer or PictBridge printer. Choose **MTP/PTP** when connecting to a PictBridge printer or using Camera Control Pro 2 or Camera Control Pro (both available separately). See “Connecting to a Computer” for information on selecting a USB option for use with Nikon Transfer (67).

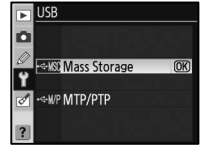
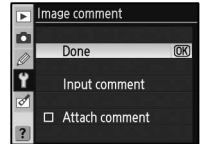

Image Comment

Add a comment to photographs as they are taken. Comments can be viewed in ViewNX (supplied) or Capture NX (available separately; 123).



- **Done:** Save changes and return to the setup menu.
- **Input comment:** The following dialog will be displayed. Input a comment as described below.

Image Comment

Keyboard area: Use multi selector to highlight letters, press to select.

Name area: Comment appears here. To move cursor, press button and use multi selector.



Comments can be up to thirty-six characters long. Any additional characters will be deleted. To delete the character at the current cursor position, press . Press **OK** to save changes and return to the image comment menu, or press **MENU** to exit without changing the comment.

- **Attach comment:** A comment is added to all photographs taken while this option is checked. Highlight this option and press the multi selector to the right to toggle the check mark on or off.



Folders

Create, rename, or delete folders or choose the folder in which new photographs will be stored.

- **Select folder:** Choose the folder in which subsequent photographs will be stored.





- **New:** Create a new folder and name it as described in “Naming Folders,” below.
- **Rename:** Select a folder from a list and rename it as described in “Naming Folders,” below.
- **Delete:** Delete all empty folders on the memory card.

Naming Folders

Keyboard area: Use multi selector to highlight letters, press  to select.

Name area: Folder name appears here. To move cursor, press  button and use multi selector.



Folder names can be up to five characters long. Any additional characters will be deleted. To delete the character at the current cursor position, press . Press **OK** to save changes and return to the setup menu, or press  to exit without creating a new folder or changing the folder name.

Folder Names

On the memory card, folder names are preceded by a three-digit folder number assigned automatically by the camera (e.g., 100NCD80). Each folder can contain up to 999 photographs. During shooting, pictures are stored in the highest-numbered folder with the selected name. If a photograph is taken when the current folder is full or contains a photograph numbered 9999, the camera will create a new folder by adding one to the current folder number (e.g., 101NCD80). The camera treats folders with the same name but different folder numbers as the same folder. For example, if the folder NIKON is selected for Select folder, photographs in all folders named NIKON (100NIKON, 101NIKON, 102NIKON, etc.) will be visible when Current is selected for Playback folder ( 75). Renaming changes all folders with the same name but leaves the folder numbers intact.

File No. Sequence

Choose how the camera names files.

- **Off** (default): File numbering is reset to 0001 when a new folder is created, the memory card is formatted, or a new memory card is inserted.
- **On**: File numbering continues from the last number used after a new folder is created, the memory card is formatted, or a new memory card is inserted. If a photograph is taken when the current folder contains a photograph numbered 9999, a new folder will be created and file numbering will begin again from 0001.
- **Reset**: As for **On**, except that file numbering is reset to 0001 with the next photograph taken (if the current folder already contains photographs, a new folder will be created).



File Numbering

If the current folder is numbered 999 and contains 999 photographs or a photograph numbered 9999, the shutter release will be disabled. If **File no. sequence** is on, turn it off and format the memory card or insert another memory card in the camera.

Mirror Lock-Up

Lock the mirror in the up position when inspecting or cleaning the low-pass filter that protects the camera image sensor ( 125).



Dust Off Ref Photo

Acquire reference data for the Image Dust Off option in Capture NX (available separately; for more information, see the Capture NX manual).

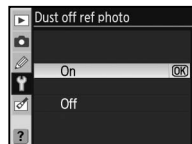

- 1 Highlight **On** and press the multi selector right. The message shown at right will be displayed, and "rEF" will be displayed in the control panel and viewfinder.



2 With the lens ten centimeters (four inches) from a well-lit, featureless white object, frame the object so that it fills the viewfinder and then press the shutter-release button halfway. In autofocus mode, focus will automatically be set to infinity; in manual focus mode, set focus to infinity manually.

3 Press the shutter-release button the rest of the way down to acquire Image Dust Off reference data. The monitor turns off when the shutter-release button is pressed.

If the reference object is too bright or too dark, the camera may be unable to acquire Image Dust Off reference data and the message shown at right will be displayed. Choose another reference object and repeat the process from Step 1.



Image Dust Off

Dust off ref photo is available with CPU lenses only. A lens with a focal length of at least 50 mm is recommended. If using a zoom lens, zoom all the way in.

The same reference image can be used for photographs taken with different lenses or at different apertures. Reference images can not be viewed using computer imaging software. A grid pattern is displayed when reference images are viewed on the camera.



Battery Info

View information on the EN-EL3e rechargeable Li-ion battery currently inserted in the camera. (If the camera is powered by an optional MB-D80 battery pack containing EN-EL3e batteries, information for each battery will be listed separately. Battery info can not be displayed when MB-D80 is used with AA batteries).

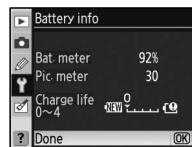

Option	Description
Bat. meter	The current battery level as a percentage of full charge.
Pic. meter	The number of times the shutter has been released since the battery was last charged. Note that the camera may sometimes release the shutter without recording a photograph (e.g., when measuring a value for preset white balance).
Charge life	A five-level display showing battery age, from 0 (new) to 4 (displayed when the battery has reached the end of its charging life and requires replacement). Note that charging life may be temporarily reduced if the battery has been charged at low temperatures; the display will return to normal if the battery is charged again at room temperature.

Firmware Version

View the current camera firmware version.



Auto Image Rotation

Photographs taken while **On** (the default option) is selected contain information on camera orientation, allowing them to be rotated automatically during playback (61) or when viewed in ViewNX (supplied) or Capture NX (available separately; 123). * The following orientations are recorded:

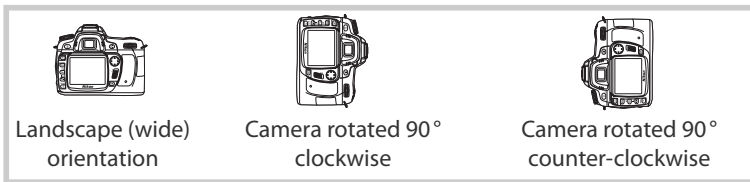
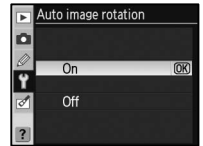

* In continuous mode (36), orientation recorded for first shot applies to all images in same burst, even if camera orientation is changed during shooting.

Camera orientation is not recorded when **Off** is selected. Choose this option when taking photographs with the lens pointing up or down.

Creating Retouched Copies: The Retouch Menu

The options in the retouch menu are used to create trimmed, resized, or retouched copies of the photographs on the memory card. The following options are available (options displayed may differ if **My menu** is selected for the **CSM/Setup** option in the setup menu; 101). See “Using Camera Menus” (9) for more information on using the menus.



Option	Description	
D-lighting	Brighten dark or back-lit subjects.	110
Red-eye correction	Correct “red-eye” caused by the flash.	111
Trim	Create cropped copies of existing photographs.	111
Monochrome	Copy pictures in black-and-white, sepia, or cyanotype.	112
Filter effects	Create copies with color filter effects.	112
Small picture	Create small copies of existing photographs.	112–113
Image overlay	Combine two RAW photographs into a single image.	114–115

Except in the case of **Image overlay**, the photographs to be copied can be selected in full-frame playback or from the retouch menu. To copy photos during full-frame playback:

1

Display photo in full-frame playback (61).

2

Display retouch menu.

3

Highlight menu item. *

4

Display retouch options. †

* **Image overlay** is not available during full-frame playback.

† If sub-menu is displayed, repeat Steps 2–3 to select options from sub-menu. To exit to full-frame playback without creating modified copy, press button.

Retouching Copies

Copies created with **Small picture** or **Trim** can not be further modified. D-lighting, red-eye correction, and filter effects can not be applied to monochrome copies. Otherwise the options in the retouch menu can each be applied once to existing copies, although this may result in loss of quality.

Image Quality

Small picture creates JPEG Fine copies (1 : 4 compression ratio). **Image overlay** creates copies at the current image quality setting. Other options copy RAW photos as JPEG Fine quality images; save where otherwise noted, copies created from RAW photos are 3,872 × 2,592 pixels in size.

To copy photos from the retouch menu:

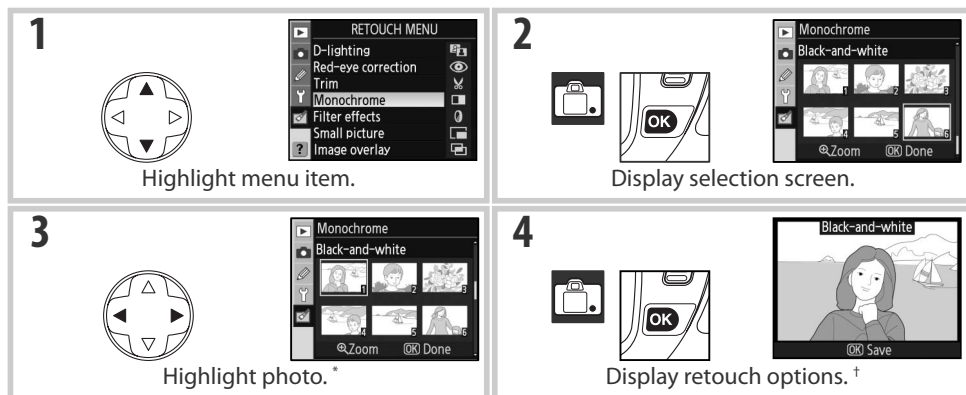

* Photos can also be highlighted using command dials: main command dial moves cursor horizontally, sub-command dial moves cursor vertically. To view selected picture full frame, press and hold  button.

† To exit to playback mode without creating modified copy, press  button.

D-Lighting

D-lighting brightens shadows, making it ideal for dark or back-lit photographs.



Before



After

Press the multi selector up or down to choose the amount of correction performed. The effect can be previewed in the edit display. Press **OK** to copy the photograph and return to the retouch menu or full-frame playback.

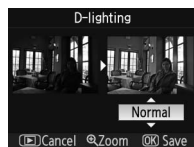







Retouching Photographs

The D80 may be unable to display or retouch photographs that were created with other models of camera or that have been modified using a computer or other device.

Red-Eye Correction





Selecting this option displays a preview image as shown below. Confirm the effects of red-eye correction and create a corrected copy as described in the following table. Note that red-eye correction may not always produce the expected results and may in very rare circumstances be applied to portions of the image that are not affected by red eye; check the preview thoroughly before proceeding. Red-eye correction is available only with photographs taken using the flash.

To	Use	Description
Zoom in and out		Press  to zoom in,  to zoom out. While photo is zoomed in, press multi selector up, down, left, or right to view areas of image not visible in monitor. Keep multi selector pressed to scroll rapidly to other areas of frame. Navigation window is displayed while  button or multi selector is pressed; area currently visible in monitor is indicated by yellow border.
View other areas of image		
Create copy		If the camera detects red eye in the selected photograph, a copy will be created that has been processed to reduce its effects. No copy will be created if the camera is unable to detect red eye.



Trim

Choosing this option displays the selected image full frame as shown below. To create a cropped copy of the selected image:

To	Use	Description
Reduce or increase size of crop		Press  to reduce crop size,  to increase. Press multi selector up, down, left, or right to view areas of image not visible in monitor.
View other areas of image		
Create copy		Save the area currently visible in the monitor as a separate file and return to the retouch menu or full-frame playback.



Trim: Image Quality and Size

Copies created from NEF (RAW) or NEF (RAW)+JPEG photos (**NEF (RAW)**, **NEF (RAW) + JPEG Fine**, **NEF (RAW) + JPEG Normal**, and **NEF (RAW) + JPEG Basic**) have an image quality of JPEG Fine; cropped copies created from JPEG photos (**JPEG Fine**, **JPEG Normal**, and **JPEG Basic**) have the same image quality as the original. Depending on the size of the crop, the copy may be 2,560 × 1,920, 1,920 × 1,440, 1,280 × 960, 960 × 720, or 640 × 480 pixels in size.

Monochrome

Choose from **Black-and-white**, **Sepia**, and **Cyanotype** (blue and white monochrome).

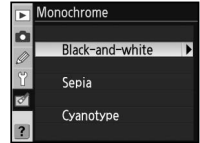

Selecting **Sepia** or **Cyanotype** displays a preview of the selected image; press the multi selector up to increase color saturation, down to decrease. Press **OK** to create a monochrome copy and return to the retouch menu or full-frame playback.



Filter Effects

Choose from the following options. After adjusting filter effects as described below, press **OK** to copy the photograph and return to the retouch menu or full-frame playback.

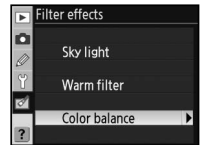

Option	Description
Skylight	Creates the effect of a sky light filter, making the picture less blue. The effect can be previewed in the monitor as shown at right.
Warm filter	Creates a copy with warm tone filter effects, giving the copy "warm" red cast. The effect can be previewed in the monitor.
Color balance	Press the multi selector up to increase the amount of green, right to increase the amount of red, left to increase the amount of blue, or down to increase the amount of magenta. The effect is displayed in the monitor together with red, green, and blue histograms giving the distribution of tones in the copy (63).

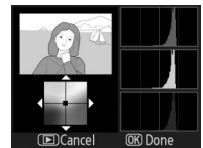











Small Picture

Create a small copy of the selected picture. The following sizes are available:

Option	Description
640 × 480	Suited to television playback.
320 × 240	Suited to display on Web pages.
160 × 120	Suitable for e-mail.

The small picture option can be used during full-frame playback as described on page 109. The procedure for selecting pictures after choosing **Small picture** from the retouch menu, however, differs from that described at the beginning of this section: instead of selecting a single photograph and then choosing a picture size, the user selects a picture size first and then selects one or more photographs to copy at the selected size as described on the following page.

Selecting **Small picture** from the retouch menu displays the menu shown in Step 1. Follow the steps below to create small copies of multiple pictures.

<p>1</p>  <p>Highlight Choose size.</p>	<p>2</p>  <p>Display options.</p>
<p>3</p>  <p>Highlight desired picture size.</p>	<p>4</p>  <p>Make selection and return to previous menu.</p>
<p>5</p>  <p>Highlight Select picture.</p>	<p>6</p>  <p>Display selection screen.</p>
<p>7</p>  <p>Select pictures (74). Selected pictures are marked with  icon.</p>	<p>8</p>  <p>Confirmation dialog displayed.</p>
<p>9</p>  <p>Highlight Yes.*</p>	<p>10</p>  <p>Copy photos and return to retouch menu.</p>

* To return to Step 7 without creating copies, highlight **No** and press **OK**. Press **MENU** to exit to retouch menu without creating copies.

Viewing Small Pictures

Small pictures are indicated by a gray border during full-frame playback. Playback zoom is not available when small pictures are displayed.

Image Overlay

Image overlay combines two existing RAW photographs to create a single picture that is saved separately from the originals. The new picture is saved at current image quality and size settings; before creating an overlay, set image quality and size (Ⓝ 33; all options are available). To create a RAW image, choose an image quality of **NEF (RAW)**.

- 1 Highlight **Image overlay** in the retouch menu and press the multi selector right. The preview dialog shown at right will be displayed with **Image 1** highlighted.



- 2 Press **OK**. A picture selection dialog will be displayed.

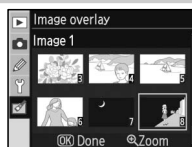

- 3 Press the multi selector left or right to highlight the first photograph in the overlay. To view the highlighted photograph full frame, press and hold the **Q** button.

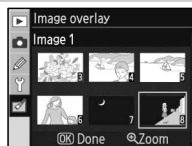

- 4 Press **OK** to select the highlighted image and return to the preview display. The selected image will appear as **Image 1**.



- 5 Optimize exposure for the overlay by pressing the multi selector up or down to select the gain for image 1 from between 0.1 and 2.0. The default value is 1.0; selecting 0.5 cuts gain in half, while selecting 2.0 doubles gain. The effects of gain are visible in the **Preview** column.



- 6 Press the multi selector left or right to highlight **Image 2**. Repeat Steps 2–5 to select the second photo and adjust gain.



7 Press the multi selector left or right to highlight the **Preview** column. Press the multi selector up or down to highlight one of the following options and press **OK**.

- **Overlay:** Preview the overlay as shown at right. Press **OK** to save the new image. To return to Step 6 and select new photos or adjust gain, press **Back**.
- **Save:** Save the overlay without viewing a preview.

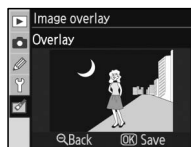
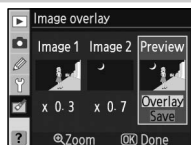

After an overlay is created, the camera will enter full-frame playback (61) with the new picture displayed in the monitor.



+

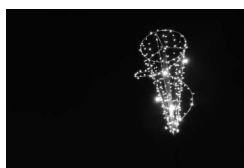

Image Overlay

Only RAW photographs created with the D80 can be selected for image overlay. Other images are not displayed on the selection screen. Hidden images are also not displayed on the selection screen and can not be selected.

The overlay has the same photo info (including date of recording, metering, shutter speed, aperture, exposure mode, exposure compensation, focal length, and image orientation) and values for white balance and optimize image as the photograph selected for **Image 1**.

Technical Notes

Optional Accessories

One advantage of digital SLR cameras is the wide variety of accessories they support. See our web sites or product catalogs for up-to-date information on accessories for the D80.

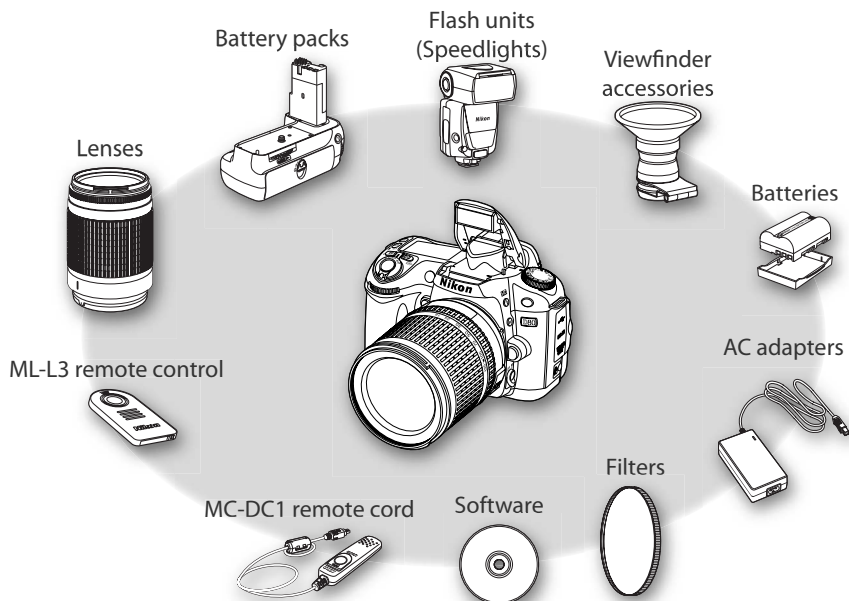

✔ Use Only Nikon Brand Electronic Accessories

Only Nikon brand accessories certified by Nikon specifically for use with your Nikon digital camera are engineered and proven to operate within its operational and safety requirements. THE USE OF NON-NIKON ACCESSORIES COULD DAMAGE YOUR CAMERA AND MAY VOID YOUR NIKON WARRANTY.

📷 Picture Angle and Focal Length

The size of the area exposed by a 35mm camera is 36×24 mm. The size of the area exposed by the D80, in contrast, is 23.6×15.8 mm, meaning that the picture angle of a 35mm camera is approximately 1.5 times that of the D80. The approximate focal length of lenses for the D80 in 35mm format can be calculated by multiplying the focal length of the lens by about 1.5.

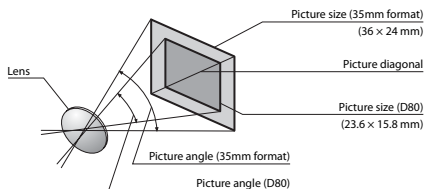

📷 Lens f-number

The f-number given in lens names is the maximum aperture of the lens.

Lenses

CPU lenses (particularly type G and D lenses) are recommended for use with the D80. CPU lenses can be identified by the presence of CPU contacts, type G and D lenses by a letter on the lens barrel. Type G lenses are not equipped with a lens aperture ring.

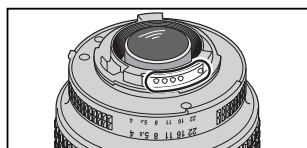

CPU lens

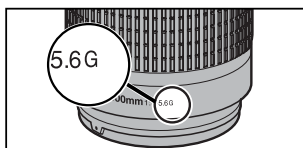

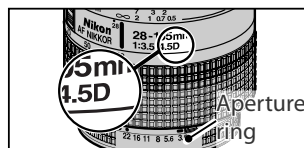

Type G lens



Type D lens

The following CPU lenses can be used with the D80. IX Nikkor CPU lenses can not be used.

Lens/accessory	Camera setting			Focus		Mode		Metering
	AF	M (with electronic rangefinder)	M	Digital Vari Program, P, S, A	M			
Type G or D AF Nikkor ² ; AF-S, AF-I Nikkor	✓	✓	✓	✓	✓	✓	✓	✓
PC-Micro Nikkor 85mm f/2.8D ³	—	✓ ⁴	✓	—	✓	✓	✓	✓
AF-S/AF-I Teleconverter ⁵	✓ ⁶	✓ ⁶	✓	✓	✓	✓	✓	✓
Other AF Nikkor (except lenses for F3AF)	✓ ⁷	✓ ⁷	✓	✓	✓	✓	✓	✓
AI-P Nikkor	—	✓ ⁸	✓	✓	✓	✓	✓	✓

1. Spot metering meters selected focus area.

2. Vibration Reduction (VR) supported with VR lenses.

3. Camera exposure metering and flash control may not function when lens is shifted and/or tilted or aperture is not at maximum.

4. Electronic rangefinder can not be used when shifting or tilting lens.

5. Compatible with the following lenses:

- **AF-S:** 80–200 mm f/2.8D ED, 300 mm f/2.8D ED II, 300 mm f/2.8D ED, 300 mm f/4D ED*, 400 mm f/2.8D ED II, 400 mm f/2.8D ED, 500 mm f/4D ED II*, 500 mm f/4D ED*, 600 mm f/4D ED II*, 600 mm f/4D ED*
- **AF-S VR:** 70–200 mm f/2.8G ED, 200 mm f/2G ED, 200–400 mm f/4G ED, 300 mm f/2.8G ED
- **AF-S Micro VR:** 105 mm f/2.8G ED (autofocus not supported)

• **AF-S NIKKOR VR:** 400 mm f/2.8G ED, 500 mm f/4G ED*, 600 mm f/4G ED*

• **AF-I:** 300 mm f/2.8D ED, 400 mm f/2.8D ED, 500 mm f/4D ED*, 600 mm f/4D ED*

* Autofocus not available with AF-S teleconverter TC-17E II/TC-20E II.

6. With maximum effective aperture of f/5.6 or faster.

7. If AF 28–85 mm f/3.5–4.5, AF 28–85 mm f/3.5–4.5 <New>, AF 35–70 mm f/2.8, or AF 80–200 mm f/2.8 is zoomed while focusing at minimum range, image on matter screen in viewfinder may not be in focus when in-focus indicator is displayed. Focus manually using image in viewfinder as guide.

8. With maximum aperture of f/5.6 or faster.

Non-CPU Lenses

The non-CPU lenses listed below may be used, but only when the camera is in mode M. Selecting another mode disables the shutter release. Aperture must be adjusted manually via the lens aperture ring and the camera autofocus system, metering, electronic analog exposure display, and TTL flash control can not be used. Except where otherwise noted, the electronic rangefinder can be used with lenses that have a maximum aperture of f/5.6 or faster.

- AI-, AI-modified NIKKOR, or Nikon Series E lenses
 - Medical-NIKKOR 120 mm f/4 (can only be used at shutter speeds slower than 1/60s)
 - Reflex-NIKKOR (electronic rangefinder can not be used)
 - PC-NIKKOR (electronic rangefinder can not be used when shifting or tilting lens)
 - AI-type teleconverter*
 - Bellows Focusing Attachment PB-6 (attach in vertical orientation; can be used in horizontal orientation once attached)*
 - Auto Extension Ring* PK-11A/12/13, PN-11
- * Electronic rangefinder can be used if maximum effective aperture is f/5.6 or faster.

Incompatible Non-CPU Lenses and Accessories

The following non-CPU lenses and accessories can NOT be used:

- AF Teleconverter TC-16A
- Non-AI lenses
- Lenses that require the Focusing Unit AU-1 (400 mm f/4.5, 600 mm f/5.6, 800 mm f/8, 1200 mm f/11)
- Fisheye (6 mm f/5.6, 8 mm f/8, OP 10 mm f/5.6)
- 2.1 cm f/4
- Extension Ring K2
- 180–600 mm f/8 ED (serial numbers 174041–174180)
- 360–1200 mm f/11 ED (serial numbers 174031–174127)
- 200–600 mm f/9.5 (serial numbers 280001–300490)
- AF-Nikkor lenses for the F3AF (AF 80mm f/2.8, AF 200mm f/3.5 ED, AF Teleconverter TC-16)
- PC 28 mm f/4 (serial number 180900 or earlier)
- PC 35 mm f/2.8 (serial numbers 851001–906200)
- Old-model PC 35 mm f/3.5
- Old-model Reflex 1000 mm f/6.3
- Reflex 1000 mm f/11 (serial numbers 142361–143000)
- Reflex 2000 mm f/11 (serial numbers 200111–200310)

AF-Assist Illumination/Red-Eye Reduction

AF-assist illumination is not available with the following lenses:

- AF-S NIKKOR 14–24mm f/2.8G ED
- AF-S VR 70–200 mm f/2.8G ED
- AF-S 80–200 mm f/2.8D ED
- AF 80–200 mm f/2.8D ED
- AF VR 80–400 mm f/4.5–5.6D ED
- AF-S VR 200 mm f/2G ED
- AF-S VR 200–400 mm f/4G ED

At ranges under 1 m (3 ft. 3 in.), the following lenses may block the AF-assist illuminator and interfere with autofocus when lighting is poor:

- AF-S DX 12–24 mm f/4G ED
- AF-S 17–35 mm f/2.8D ED
- AF-S DX 17–55 mm f/2.8G ED
- AF 18–35 mm f/3.5–4.5D ED
- AF-S DX 18–70 mm f/3.5–4.5G ED
- AF-S DX VR 18–200 mm f/3.5–5.6G
- AF 20–35 mm f/2.8D
- AF-S NIKKOR 24–70mm f/2.8G ED
- AF-S 24–85 mm f/3.5–4.5G ED
- AF 24–85 mm f/2.8–4D
- AF-S VR 24–120 mm f/3.5–5.6G ED
- AF 24–120 mm f/3.5–5.6D
- AF-S 28–70 mm f/2.8D ED
- AF 28–200 mm f/3.5–5.6G ED
- AF Micro 70–180 mm f/4.5–5.6D ED
- AF-S VR Micro 105 mm f/2.8G ED
- AF Micro 200 mm f/4D ED

Lenses that block the subject's view of the AF-assist illuminator can interfere with red-eye reduction.

The Built-in Flash

The built-in flash can be used with CPU lenses with focal lengths of 18–300 mm. The flash may be unable to light the entire subject with the following lenses at ranges less than those given below:

Lens	Zoom position	Min. range	Lens	Zoom position	Min. range
AF-S DX 12–24 mm f/4G ED	20 mm	2.0m/6ft. 7in.	AF 20–35 mm f/2.8D	20 mm	1.5m/4ft. 11 in.
	24 mm	1.0m/3ft. 3in.		24 mm	1.0m/3ft. 3in.
AF-S 17–35 mm f/2.8D ED	24 mm	2.0m/6ft. 7in.	AF-S NIKKOR 24–70 mm f/2.8G ED	35 mm	1.0m/3ft. 3in.
	28mm, 35mm	1.0m/3ft. 3in.		AF-S VR 24–120 mm f/3.5–5.6G ED	24 mm
AF-S DX 17–55 mm f/2.8G ED	28 mm	1.5m/4ft. 11 in.	AF-S 28–70 mm f/2.8D ED		35 mm
	35 mm	1.0m/3ft. 3in.		50 mm	1.0m/3ft. 3in.
AF 18–35 mm f/3.5–4.5D ED	24 mm	1.0m/3ft. 3in.	AF-S VR 200–400 mm f/4G ED	200 mm	3.0m/9ft. 10 in.
AF-S DX 18–70 mm f/3.5–4.5G ED	18 mm	1.0m/3ft. 3in.		250 mm, 300 mm	2.5m/8ft. 2in.
AF-S DX 18–135 mm f/3.5–5.6G ED	18 mm	1.5m/4ft. 11 in.			
AF-S DX VR 18–200 mm f/3.5–5.6G ED	24 mm, 35 mm	1.0m/3ft. 3in.			

When used with the AF-S NIKKOR 14–24 mm f/2.8G ED, the flash will be unable to light the entire subject at all ranges.

The built-in flash can also be used with compatible non-CPU lenses with a focal length of 18–200 mm. AI and AI-S 200 mm f/2 ED lenses can not be used. Restrictions apply with the following lenses:

- **AI-S 25–50 mm f/4, AI 25–50 mm f/4, AI-S 35–70 mm f/4:** at 35mm zoom position, use at ranges of 1 m (3 ft. 3 in.) or more
- **AI, AI-modified, and AI-S ED 50–300 mm f/4.5, AI-modified 85–250 mm f/4:** use at 135mm or above

Optional Flash Units (Speedlights)

Use the accessory shoe to mount optional flash units directly on the camera without a sync cable. The accessory shoe is equipped with a safety lock for Speedlights with a locking pin, such as the SB-800, SB-600 and SB-400. Before attaching an optional flash unit, remove the accessory shoe cover. The built-in flash will not fire when an optional Speedlight is attached.

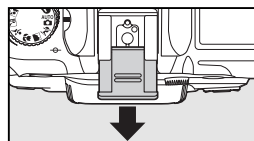

When used with compatible flash units such as the optional SB-800 and SB-600 Speedlights or SB-R200 wireless remote Speedlight, the D80 supports the advanced Nikon Creative Lighting System (CLS), including i-TTL flash control (📷 141), FV lock (locks flash level; 📷 92), and Auto FP High-Speed Sync (synchronizes the flash and shutter at high shutter speeds). With the built-in flash in commander mode, the D80 can be used to control remote SB-800, SB-600, and SB-R200 flash units. See the Speedlight manual for details.

SB-800, SB-600, and SB-400 Speedlights

These high-performance Speedlights have Guide Numbers of 38/125 (35mm zoom head position), 30/98 (35mm zoom head position), and 21/69 respectively (m/ft, ISO 100, 20°C/68°F). The flash head can be rotated through 90° above the horizontal for bounce-flash or close-up photography. The SB-800 and SB-600 can also be rotated 180° left, and 90° right, and the SB-800 can be rotated 7° below the horizontal. The SB-800 and SB-600 support auto power zoom (24–105 mm and 24–85 mm, respectively), ensuring that the illuminating angle is adjusted in accord with lens focal length and have both a built-in wide panel that can be used for an angle of 14 mm (the SB-800 also supports 17 mm) and an illuminator that can be used when adjusting settings in the dark.

✔ Use Only Nikon Flash Accessories

Use only Nikon Speedlights. Negative voltages or voltages over 250 V applied to the accessory shoe could not only prevent normal operation, but damage the sync circuitry of the camera or flash. Before using a Nikon Speedlight not listed in this section, contact a Nikon-authorized service representative for more information.

📷 Guide Number

To calculate the range of the flash at an ISO sensitivity of 100, divide the Guide Number by the aperture. For example, the built-in flash has a Guide Number of 13 m or 42 ft. (ISO 100, 20°C/68°F); its range at an aperture of f/5.6 is $13 \div 5.6$ or about 2.3 meters (or in feet, $42 \div 5.6 =$ about 7.5 ft). With Guide Numbers of 38 and 30, the SB-800 and SB-600 respectively have ranges of about 6.8 and 5.4 meters (22.3 and 17.5 feet) at f/5.6 (35mm zoom head position).

📷 The AS-15 Accessory Shoe Adapter

When the AS-15 accessory shoe adapter (available separately) is mounted on the camera accessory shoe, flash accessories can be connected via a sync cable.

SB-R200 Wireless Remote Speedlight

This high-performance wireless remote Speedlight has a Guide Number of 10/32 (m/ft, ISO 100, 20°C/68°F). Although it can not be mounted directly on the accessory shoe, the SB-R200 serves as a remote flash when the built-in flash is in commander mode. It can also be controlled using an optional SB-800 Speedlight or SU-800 wireless Speedlight commander. The SB-R200 can be hand-held, placed on an AS-20 Speedlight stand, or mounted on the camera lens using the SX-1 attachment for remote control and close-up i-TTL photography.

The following features are available with CLS-compatible flash units:

Flash mode/feature		Speedlight			Advanced Wireless Lighting				
		SB-800	SB-600	SB-400	Commander		Remote		
					SB-800	SU-800 ¹	SB-800	SB-600	SB-R200
i-TTL ^{2,3}		✓	✓	✓	✓	✓	✓	✓	✓
AA	Auto aperture ²	✓ ⁴	—	—	✓ ⁵	✓ ⁶	✓ ⁵	—	—
A	Non-TTL auto	✓ ⁴	—	—	✓ ⁵	—	✓ ⁵	—	—
GN	Range-priority manual	✓	—	—	—	—	—	—	—
M	Manual	✓	✓	—	✓	✓	✓	✓	✓
RPT	Repeating flash	✓	—	—	✓	✓	✓	✓	—
REAR	Rear-curtain sync	✓	✓	✓	✓	✓	✓	✓	✓
	Red-eye reduction	✓	✓	✓	✓	—	—	—	—
Flash Color Information Communication		✓	✓	✓	✓	—	—	—	—
Auto FP High-Speed Sync ⁶		✓	✓	—	✓	✓	✓	✓	✓
FV Lock		✓	✓	✓	✓	✓	✓	✓	✓
AF-assist for multi-area AF ²		✓	✓	—	✓	✓	—	—	—
Auto zoom		✓	✓	—	✓	—	—	—	—
Auto ISO		✓	✓	✓	—	—	—	—	—

1. Options shown are only available when SU-800 is used to control other flash units.

2. CPU lens required.

3. Standard i-TTL for Digital SLR is used with spot metering or when selected with Speedlight. Otherwise i-TTL Balanced Fill-Flash for Digital SLR is used.

4. Use Speedlight controls to select flash mode. Non-TTL auto is selected automatically when a non-CPU lens is attached.

5. Auto aperture is selected automatically if CPU lens is attached. Non-TTL auto is selected automatically if non-CPU lens is attached.

6. Use Speedlight controls to select flash mode.

The following Speedlights can be used in non-TTL auto and manual modes. If they are set to TTL, the camera shutter-release button will lock and no photographs can be taken.

Flash mode		Speedlight	SB-80DX, SB-28DX, SB-28, SB-26, SB-25, SB-24	SB-50DX, SB-23, SB-29 ¹ , SB-21B ¹ , SB-29s ¹	SB-30, SB-27 ² , SB-22S, SB-22, SB-20, SB-16B, SB-15
A	Non-TTL auto		✓	—	✓
M	Manual		✓	✓	✓
RPT	Repeating flash		✓	—	—
REAR	Rear-curtain sync		✓	✓	✓





1. Autofocus is available only with AF-Micro lenses (60 mm, 105 mm, or 70–180 mm).

2. When mounted on D80, flash mode is automatically set to TTL and shutter release is disabled. Set Speedlight to A (non-TTL auto) mode.

Notes on Optional Speedlights

Refer to the Speedlight manual for detailed instructions. If the Speedlight supports the Creative Lighting System, refer to the section on CLS-compatible digital SLR cameras. The D80 is not included in the “digital SLR” category in the SB-80DX, SB-28DX, and SB-50DX manuals.

If an optional Speedlight is attached with the camera in a Digital Vari-Program mode, the flash will fire whenever a photograph is taken. The following flash modes are available:

- **P, AUTO, , , , and  modes:** Fill flash and red-eye reduction. Fill flash is automatically selected if the flash mode is set to off or auto when an optional Speedlight is attached. Auto with red-eye reduction becomes red-eye reduction.
- ** mode:** Auto slow sync becomes slow sync, auto slow sync with red-eye reduction becomes slow sync with red-eye reduction, and off becomes slow sync.

If **AUTO** is selected for ISO sensitivity in Digital Vari-Program modes or **On** is selected for Custom Setting 7 (**ISO Auto**) in **P, S, A, or M** mode, ISO sensitivity will be adjusted for optimal flash output when an optional SB-800, SB-600, or SB-400 Speedlight is attached. This may result in foreground subjects being underexposed in photographs taken with the flash at slow shutter speeds, in daylight, or against a bright background. Choose a flash mode other than slow sync or choose a larger aperture.

If Auto FP High Speed Sync is used, the shutter will synchronize with an external flash at speeds of 1/200s or slower.



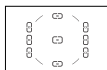

i-TTL flash control can be used at ISO sensitivities between 100 and 1600. Higher values may not produce the desired results at some ranges or apertures. If the flash-ready indicator blinks for about three seconds after a photograph is taken, the flash has fired at full power and the photograph may be underexposed.

The optional SB-800 and SB-600 Speedlights and SU-800 wireless Speedlight commander provide active AF assist illumination for the following focus areas:

- 24–34 mm AF lens 
- 35–105 mm AF lens 

The SB-800, SB-600, and SB-400 also provide red-eye reduction. With other Speedlights, the camera AF assist illuminator is used for AF-assist illumination and red-eye reduction.

In the following modes, the maximum aperture (minimum f-number) selectable by the camera is limited according to ISO sensitivity ( 43):

Mode	Maximum aperture at ISO sensitivity of												
	100	125	160	200	250	320	400	500	640	800	1000	1250	1600
P, AUTO, , , , and 	4	4.2	4.5	4.8	5	5.3	5.6	6	6.3	6.7	7.1	7.6	8
	5.6	6	6.3	6.7	7.1	7.6	8	8.5	9	9.5	10	11	11

For each one-step increase in sensitivity (e.g., from 200 to 400), aperture is stopped down by half an f-stop. If the maximum aperture of the lens is smaller than given above, the maximum value for aperture will be the maximum aperture of the lens.

When an SC-series 17, 28, or 29 sync cable is used for off-camera flash photography, correct exposure may not be achieved in i-TTL mode. We recommend that you choose spot metering to select standard i-TTL flash control. Take a test shot and view the results in the monitor.

In i-TTL mode, use the flash panel or bounce adapter provided with the Speedlight. Do not use other panels such as diffusion panels, as this may produce incorrect exposure. Auto power zoom is available only with SB-800 and SB-600 Speedlights.

Other Accessories

Viewfinder eyepiece accessories

- **Diopter adjustment viewfinder lenses:** Lenses are available with diopters of -5 , -4 , -3 , -2 , 0 , $+0.5$, $+1$, $+2$, and $+3$ m^{-1} . Use diopter adjustment lenses only if the desired focus can not be achieved with the built in diopter adjustment control (-2.0 to $+1.0$ m^{-1}). Test diopter adjustment lenses before purchase to ensure that the desired focus can be achieved.
- **DK-21M magnifying eyepiece:** Increases viewfinder magnification to approximately $1.10 \times$ (50 mm f/1.4 lens at infinity; -1.0 m^{-1}).
- **DG-2 magnifier:** Magnify the scene displayed in the center of the viewfinder for close-up photography, copying, telephoto lenses, and other tasks that require added precision. Eyepiece adapter required (available separately).
- **DK-22 eyepiece adapter:** Attach the DG-2 magnifier to the D80.
- **DR-6 right-angle viewing attachment:** The DR-6 attaches at a right angle to the viewfinder eyepiece, allowing the image in the viewfinder to be viewed from above when the camera is in portrait orientation.

Filters

- Nikon filters can be divided into three types: screw-in, slip-in, and rear-interchange. Use Nikon filters; other filters may interfere with autofocus or electronic range finding.
- The D80 can not be used with linear polarizing filters. Use the C-PL circular polarizing filter instead.
- The NC and L37C filters are recommended for protecting the lens.
- Moiré may occur if a filter is used when the subject is framed against a bright light or when a bright light source is in the frame.
- Center-weighted metering is recommended with filters with exposure factors (filter factors) over $1 \times$ (Y44, Y48, Y52, O56, R60, X0, X1, C-PL, ND2S, ND4, ND4S, ND8, ND8S, ND400, A2, A12, B2, B8, B12).

Approved Memory Cards

The following SD memory cards have been tested and approved for use in the D80. All cards of the designated make and capacity can be used, regardless of speed.

SanDisk	64 MB, 128 MB, 256 MB, 512 MB, 1 GB, 2 GB*, 4 GB††	128 MB, 256 MB, 512 MB, 1 GB, 2 GB*
Toshiba	64 MB, 128 MB, 256 MB, 512 MB, 1 GB, 2 GB*, 4 GB††	Lexar Platinum II: 512 MB, 1 GB, 2 GB*
Panasonic	64 MB, 128 MB, 256 MB, 512 MB, 1 GB, 2 GB*, 4 GB††	Professional: 1 GB, 2 GB*

* If card will be used with card reader or other device, check that device supports 2 GB and 4 GB cards.

† SDHC compliant. If card will be used with card reader or other device, check that device supports SDHC.



Operation is not guaranteed with other makes of card. Contact the manufacturer for details on the above cards.

✓ Memory Cards

- Format memory cards in the camera before first use.
- Turn the power off before inserting or removing memory cards. Do not remove memory cards from the camera, turn the camera off, or remove or disconnect the power source during formatting or while data are being recorded, deleted, or copied to a computer. Failure to observe these precautions could result in loss of data or in damage to the camera or card.
- Do not touch the card terminals with your fingers or metal objects.
- Do not apply force to the card casing. Failure to observe this precaution could damage the card.
- Do not bend, drop, or subject to strong physical shocks.
- Do not expose to heat, water, high levels of humidity, or direct sunlight.

Accessories for the D80

At the time of writing, the following accessories were available for the D80. Up to date information is available at Nikon websites or from our latest product catalogs.

Power sources

- **EN-EL3e rechargeable Li-ion battery:** Additional EN-EL3e batteries are available from local retailers and Nikon service representatives. EN-EL3a and EN-EL3 batteries can not be used.
- **MB-D80 Multi-Power battery pack:** The MB-D80 takes one or two rechargeable Nikon EN-EL3e Li-ion batteries or six AA alkaline, Ni-MH, lithium, or nickel-manganese batteries. It is equipped with a shutter-release button, main and sub-command dials, and an AE-L/AF-L button for ease of use when taking photographs in tall (portrait) orientation. When attaching the MB-D80, remove the camera battery cover as shown at right.
- **EH-5/EH-5a AC adapter:** Use to power the camera for extended periods.

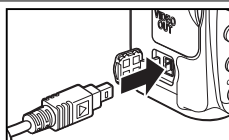
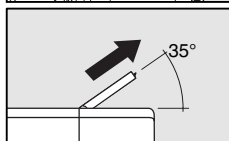
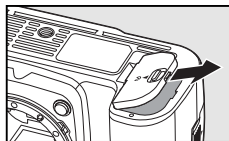

Remote controls and cords

- **MC-DC1 remote cord:** Prevents blur caused by camera shake and features a shutter-release button lock for long time-exposures. When connecting the MC-DC1, open the remote cord connector cover and insert the cord as shown. To prevent water from entering the camera, keep the remote cord connector cover closed when not in use.
- **ML-L3 wireless remote control:** Use as a remote shutter release for self-portraits or to prevent blur caused by camera shake. The ML-L3 uses a 3 V CR2025 battery.

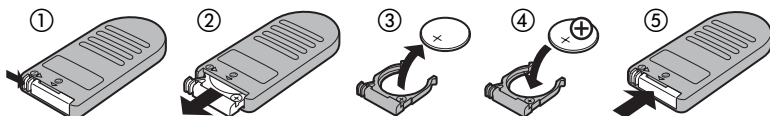

Body cap

- **BF-1A Body Cap:** The BF-1A keeps the mirror, viewfinder screen, and low-pass filter free of dust when a lens is not in place.

Software

- **Capture NX:** A complete photo editing package with support for RAW images. Use the latest version.
- **Camera Control Pro 2:** Control the camera remotely from a computer and save photographs directly to the computer hard disk.

Note: The D80 is also supported under Camera Control Pro version 1.1.0 and later. Capture NX and Camera Control Pro automatically checks for updates if an Internet connection is detected at startup. Be sure to update to the latest version.

Caring for the Camera

Storage

When the camera will not be used for an extended period, turn the camera off, replace the monitor cover, remove the battery, and store the battery in a cool, dry area with the terminal cover in place. To prevent mold or mildew, store the camera in a dry, well-ventilated area. Do not store the camera with naphtha or camphor moth balls or in locations that:

- are poorly ventilated or subject to humidities of over 60%
- are next to equipment that produces strong electromagnetic fields, such as televisions or radios
- are exposed to temperatures above 50 °C/122 °F (for example, near a space heater or in a closed vehicle in a hot day) or below -10 °C (14 °F)

Cleaning

Camera body	Use a blower to remove dust and lint, then wipe gently with a soft, dry cloth. After using the camera at the beach or seaside, wipe off sand or salt with a cloth lightly dampened in distilled water and dry thoroughly. Important: <i>Dust or other foreign matter inside the camera may cause damage not covered under warranty.</i>
Lens, mirror, and viewfinder	These elements are made of glass and are easily damaged. Remove dust and lint with a blower. If using an aerosol blower, keep the can vertical to prevent the discharge of liquid. To remove fingerprints and other stains, apply a small amount of lens cleaner to a soft cloth and clean with care.
Monitor	Remove dust and lint with a blower. When removing fingerprints and other stains, wipe the surface lightly with a soft cloth or chamois leather. Do not apply pressure, as this could result in damage or malfunction.

The Monitor

Should the monitor break, care should be taken to avoid injury caused by broken glass and to prevent liquid crystal from the monitor from entering your eyes or mouth.

The Control Panel

In rare cases, static electricity may cause the control panel to brighten or darken. This does not indicate a malfunction, and the display will soon return to normal.

The Low-Pass Filter

The image sensor that acts as the camera's picture element is fitted with a low-pass filter to prevent moiré. If you suspect that dirt or dust on the filter is appearing in photographs, you can clean the filter as described below. Note, however, that the filter is extremely delicate and easily damaged. Nikon recommends that the filter be cleaned only by Nikon-authorized service personnel.

1 A reliable power source is required when inspecting or cleaning the low-pass filter. If the battery level is  or below or the camera is powered by an optional MB-D80 battery pack with AA batteries, turn the camera off and insert a fully-charged EN-EL3e battery or connect an optional EH-5/EH-5a AC adapter.

2 Remove the lens and turn the camera on. Press the MENU button to display the camera menus and select Mirror lock-up from the setup menu (note that this option is not available at battery levels of  or below, while recording a multiple exposure, or when using an optional MB-D80 battery pack with AA batteries). The menu shown at right will be displayed.



3 Highlight **On** and press **OK**. The message shown at right will be displayed in the monitor and a row of dashes will appear in the control panel and viewfinder. To restore normal operation without inspecting the low-pass filter, turn the camera off.

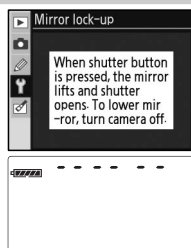

4 Press the shutter-release button all the way down. The mirror will be raised and the shutter curtain will open, revealing the low-pass filter. The display in the viewfinder will turn off and the row of dashes in the control panel will blink.



5 Holding the camera so that light falls on the low-pass filter, examine the filter for dust or lint. If no foreign objects are present, proceed to Step 7.

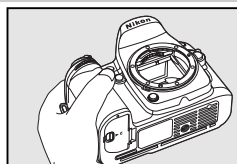

6 Remove any dust and lint from the filter with a blower. Do not use a blower-brush, as the bristles could damage the filter. Dirt that can not be removed with a blower can only be removed by Nikon-authorized service personnel. Under no circumstances should you touch or wipe the filter.



7 Turn the camera off. The mirror will be lowered and the shutter curtain will close. Replace the lens or body cap.

✓ Use a Reliable Power Source

The shutter curtain is delicate and easily damaged. If the camera powers off while the mirror is raised, the curtain will close automatically. To prevent damage to the curtain, observe the following precautions:

- Do not turn the camera off or remove or disconnect the power source while the mirror is raised.
- If the battery runs low while the mirror is raised, a beep will sound and the AF-assist illuminator will blink to warn that the shutter curtain will close and the mirror will be lowered after about two minutes. End cleaning or inspection immediately.

✓ Foreign Matter on the Low-Pass Filter

Nikon takes every possible precaution to prevent foreign matter from coming into contact with the low-pass filter during production and shipping. The D80, however, is designed to be used with interchangeable lenses, and foreign matter may enter the camera when lenses are removed or exchanged. Once inside the camera, this foreign matter may adhere to the low-pass filter, where it may appear in photographs taken under certain conditions. To protect the camera when no lens is in place, be sure to replace the body cap provided with the camera, being careful to first remove all dust and other foreign matter that may be adhering to the body cap.

Should foreign matter find its way onto the low-pass filter, clean the filter as described above, or have the filter cleaned by authorized Nikon service personnel. Photographs affected by the presence of foreign matter on the filter can be retouched using Capture NX (available separately;  123) or the clean image options available in some third-party imaging applications.

✓ Servicing the Camera and Accessories

The D80 is a precision device and requires regular servicing. Nikon recommends that the camera be inspected by the original retailer or Nikon service representative once every one to two years, and that it be serviced once every three to five years (note that fees apply to these services). Frequent inspection and servicing are particularly recommended if the camera is used professionally. Any accessories regularly used with the camera, such as lenses or optional Speedlights, should be included when the camera is inspected or serviced.

Caring for the Camera and Battery: Cautions

Do not drop: The product may malfunction if subjected to strong shocks or vibration.

Keep dry: This product is not waterproof, and may malfunction if immersed in water or exposed to high levels of humidity. Rusting of the internal mechanism can cause irreparable damage.

Avoid sudden changes in temperature: Sudden changes in temperature, such as occur when entering or leaving a heated building on a cold day, can cause condensation inside the device. To prevent condensation, place the device in a carrying case or plastic bag before exposing it to sudden changes in temperature.

Keep away from strong magnetic fields: Do not use or store this device in the vicinity of equipment that generates strong electromagnetic radiation or magnetic fields. Strong static charges or the magnetic fields produced by equipment such as radio transmitters could interfere with the monitor, damage data stored on the memory card, or affect the product's internal circuitry.

Do not leave the lens pointed at the sun: Do not leave the lens pointed at the sun or other strong light source for an extended period. Intense light may cause the image sensor to deteriorate or produce a white blur effect in photographs.

Blooming: Vertical white streaks may appear in photographs of the sun or other strong light sources. This phenomenon, known as "blooming," can be prevented by reducing the amount of light that falls on the image sensor, either by choosing a slow shutter speed and small aperture or by using an ND filter.

Do not touch the shutter curtain: The shutter curtain is extremely thin and easily damaged. Under no circumstances should you exert pressure on the curtain, poke it with cleaning tools, or subject it to powerful air currents from a blower. These actions could scratch, deform, or tear the curtain.

Handle all moving parts with care: Do not apply force to the battery-chamber, card-slot, or connector covers. These parts are especially susceptible to damage.

Turn the product off before removing or disconnecting the power source: Do not unplug the product or remove the battery while the product is on or while images are being recorded or deleted. Forcibly cutting power in these circumstances could result in loss of data or in damage to product memory or internal circuitry. To prevent an accidental interruption of power, avoid carrying the product from one location to another while the AC adapter is connected.

Lens contacts: Keep the lens contacts clean.

Cleaning: When cleaning the camera body, use a blower to gently remove dust and lint, then wipe gently with a soft, dry cloth. After using the camera at the beach or seaside, wipe off any sand or salt using a cloth lightly dampened in pure water and then dry the camera thoroughly. In rare instances, static electricity may cause the LCD displays to light up or go dark. This does not indicate a malfunction, and the display will soon return to normal.

The lens and mirror are easily damaged. Dust and lint should be gently removed with a blower. When using an aerosol blower, keep the can vertical to prevent discharge of liquid. To remove fingerprints and other stains from the lens, apply a small amount of lens cleaner to a soft cloth and wipe the lens carefully.

See "The Low-Pass Filter" (📖 125) for information on cleaning the low-pass filter.

Storage: To prevent mold or mildew, store the camera in a dry, well-ventilated area. If the product will not be used for an extended period, remove the battery to prevent leakage and store the camera in a plastic bag containing a desiccant. Do not, however, store the camera case in a plastic bag, as this may cause the material to deteriorate. Note that desiccant gradually loses its capacity to absorb moisture and should be replaced at regular intervals.

To prevent mold or mildew, take the camera out of storage at least once a month. Turn the camera on and release the shutter a few times before putting it away.

Store the battery in a cool, dry place. Replace the terminal cover before putting the battery away.

Notes on the monitor: The monitor may contain a few pixels that are always lit or that do not light. This is common to all TFT LCD monitors and does not indicate a malfunction. Images recorded with the product are unaffected.

Images in the monitor may be difficult to see in a bright light.

Do not apply pressure to the monitor, as this could cause damage or malfunction. Dust or lint on the monitor can be removed with a blower. Stains can be removed by wiping lightly with a soft cloth or chamois leather. Should the monitor break, care should be taken to avoid injury from broken glass and to prevent liquid crystal from the monitor touching the skin or entering the eyes and mouth.

Replace the monitor cover when transporting the camera or leaving it unattended.



Batteries: Dirt on the battery terminals can prevent the camera from functioning and should be removed with a soft, dry cloth before use.

Batteries may leak or explode if improperly handled. Observe the following precautions when handling batteries:

- Turn the product off before replacing the battery.
- The battery may become hot when used for extended periods. Observe due caution when handling the battery.
- Use only batteries approved for use in this equipment.
- Do not expose the battery to flame or excessive heat.
- After removing the battery from the camera, be sure to replace the terminal cover.

Charge the battery before use. When taking photographs on important occasions, ready a spare EN-EL3e battery and keep it fully charged. Depending on your location, it may be difficult to purchase replacement batteries on short notice.



On cold days, the capacity of batteries tends to decrease. Be sure the battery is fully charged before taking photographs outside in cold weather. Keep a spare battery in a warm place and exchange the two as necessary. Once warmed, a cold battery may recover some of its charge.

Continuing to charge the battery after it is fully charged can impair battery performance.

Used batteries are a valuable resource. Please recycle used batteries in accord with local regulations.

Troubleshooting

If the camera fails to function as expected, check the list of common problems below before consulting your retailer or Nikon representative. Refer to the page numbers in the right-most column for more information.

Problem	Solution	
Camera takes time to turn on.	Delete files or folders.	65, 74, 105
Viewfinder is out of focus.	Adjust viewfinder focus or use optional diopter adjustment lenses.	17, 122
Viewfinder is dark.	Insert a fully-charged battery.	12
Displays turn off without warning.	Choose longer delays for Custom Setting 27 (Monitor off) or 28 (Auto meter off).	98, 99
Unusual characters displayed in control panel.	See "A Note on Electronically-Controlled Cameras," below.	—
Displays in control panel or viewfinder are unresponsive and dim.	The response times and brightness of these displays varies with temperature.	—
Fine lines are visible around active focus area or display turns red when focus area is highlighted.	These phenomena are normal for this type of viewfinder and do not indicate a malfunction.	—
Menu item is not displayed.	Select Full for CSM / setup menu .	101
Menu item can not be selected.	Rotate mode dial to another setting or insert memory card. Note that Battery info option is only available when camera is powered by EN-EL3e battery.	107
Image size can not be changed.	Image quality set to NEF (RAW) .	34
Metering can not be changed.	Digital Vari-Program mode selected or autoexposure lock in effect.	24, 94
Exposure compensation not available.	Choose mode P , S , or A .	45
Can not measure white balance.	Subject is too dark or too bright.	60
Image can not be selected as source for preset white balance.	Image was not created with D80.	82
White balance bracketing unavailable.	<ul style="list-style-type: none"> • NEF (RAW) or NEF + JPEG option selected for image quality. •  (Choose color temp.) selected for white balance. • Multiple exposure in progress. 	34, 59, 84

A Note on Electronically-Controlled Cameras

In extremely rare instances, unusual characters may appear in the control panel and the camera may stop functioning. In most cases, this phenomenon is caused by a strong external static charge. Turn the camera off, remove and replace the battery (note that the battery may be hot) or disconnect and reconnect the AC adapter, and turn the camera on again. If the problem persists, turn the camera off and press the reset switch (see right; note that this resets the clock). In the event of continued malfunction, contact your retailer or a Nikon-authorized service representative.

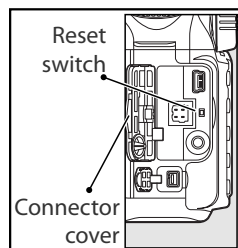

















Problem	Solution	
Full range of shutter speeds not available.	Flash in use. If On is selected for Custom Setting 25 (Auto FP) modes P , S , A , and M , optional SB-800, SB-600, and SB-R200 Speedlights can be used at all shutter speeds.	98, 119
Can not select focus area.	<ul style="list-style-type: none"> • Unlock focus area selector. • Auto-area AF selected for Custom Setting 2 (AF-area mode): choose another mode. • Press shutter-release button halfway to turn monitor off or activate exposure meters. 	30 87 18
Focus does not lock when shutter-release button is pressed halfway.	Use AE-L/AF-L button to lock focus when AF-C autofocus mode is selected or when photographing moving subjects in AF-A mode.	29, 94
Image in viewfinder is not in focus.	<ul style="list-style-type: none"> • Rotate focus mode selector to AF. • Camera unable to focus using autofocus: use manual focus or focus lock. 	31, 32
AF-assist illuminator does not light.	<ul style="list-style-type: none"> • Mode dial rotated to , , or : select another mode. • AF-assist lamp does not light for continuous-servo autofocus. Set autofocus mode to AF-S. • Custom Setting 2 (AF-area mode) set to Auto-area AF or Dynamic area: select center focus area. • Choose On for Custom Setting 4 (AF assist). • Illuminator has turned off automatically. Illuminator may become hot with continued use; wait for lamp to cool down. 	24 29 87 87 —
Shutter release is disabled.	<ul style="list-style-type: none"> • Memory card is full, locked, or not inserted. • Flash is charging. • Camera is not in focus. • CPU lens with aperture ring attached without locking aperture at highest f-number. • Non-CPU lens is attached: rotate camera mode dial to M. • Mode dial rotated to S after shutter speed of bulb selected in mode M: choose new shutter speed. 	15 23 22 11, 117 50 48
No photo taken when remote control shutter-release button is pressed.	<ul style="list-style-type: none"> • Replace battery in remote control. • Choose remote control mode. • Flash is charging. • Time selected for Custom Setting 30 (Remote) has passed: reselect remote control mode. • Bright light is interfering with remote. 	123 38 23 99 —
Only one shot taken each time shutter-release button is pressed in continuous shooting mode.	<ul style="list-style-type: none"> • P, S, A, and M modes: lower flash. • Digital Vari-Program modes: turn flash off. 	23 40
Camera is slow to record photos.	Turn long exposure noise reduction off.	83
Date of recording is not correct.	Set camera clock.	103

Problem	Solution	
Final photo is larger than area shown in viewfinder.	Viewfinder horizontal and vertical frame coverage is approximately 95%.	—
Randomly-spaced bright pixels (“noise”) appears in photographs.	<ul style="list-style-type: none"> • Lower ISO sensitivity or use high ISO noise reduction. • Shutter speed is slower than 8s: use long exposure noise reduction. 	43, 83 83
Reddish areas appear in photos.	Reddish areas may appear in long time-exposures. Turn long exposure noise reduction On when shooting at shutter speeds of “bulb” or “--”.	83
Photos are blotched or smeared.	<ul style="list-style-type: none"> • Clean lens. • Clean low-pass filter. 	124 125
Colors are unnatural.	<ul style="list-style-type: none"> • Select mode P, S, A, or M and adjust white balance to match light source. • Select mode P, S, A, or M and adjust Optimize image settings. 	45, 58 45, 79
Flashing areas appear in images.	Press multi selector up or down or rotate sub-command dial to choose photo information displayed.	62, 63
Shooting data appear on images.		
A graph appears during playback.		
RAW image is not played back.	Photo was taken at image quality of NEF + JPEG.	34
<ul style="list-style-type: none"> • Some photos are not displayed during playback. • Message displayed stating that no images are available for playback. 	Select All for Playback folder . Note that Current will automatically be selected when next photo is taken.	75
“Tall” (portrait) orientation photos are displayed in “wide” (landscape) orientation.	<ul style="list-style-type: none"> • Select On for Rotate tall. • Photo was taken with Off selected for Auto image rotation. 	75 108
	• Camera orientation was changed while shutter-release button was pressed in continuous shooting mode.	108
	• Camera was pointed up or down when photo was taken.	108
Can not retouch photo.	<ul style="list-style-type: none"> • Some retouch options can not be applied to copies. • Photo created or modified with other device. 	109 110
Can not delete photo.	Photo is protected: remove protection.	65
Can not change print order.	Memory card is full or locked.	15, 19
Can not select photo for printing.	Photo is in RAW (NEF) format. Transfer to computer and print using ViewNX (supplied) or Capture NX (available separately).	67, 123
Can not print pictures via direct USB connection.	Set USB to MTP/PTP .	67, 104
Photo is not displayed on TV.	Choose correct video mode.	103
Can not copy photos to computer.	Choose correct USB option.	67, 104
Can not use Camera Control Pro 2 or Camera Control Pro.	<ul style="list-style-type: none"> • Set USB to MTP/PTP. • Camera Control Pro: update software to latest version. 	67, 104 123

Camera Error Messages and Displays

This section lists the warning indicators and error messages that appear in the viewfinder, control panel, and monitor.

Indicator		Problem	Solution	
Control panel	Viewfinder			
	FE E (blinks)	Lens aperture ring not locked at minimum aperture.	Lock ring at minimum aperture (highest f-number).	11
	F - - (blinks)	<ul style="list-style-type: none"> No lens attached. Non-CPU lens attached. 	<ul style="list-style-type: none"> Attach lens (IX Nikkor excluded). Select mode M. 	7, 117 50
		Low battery.	Ready fully-charged spare battery.	12, 123
 (blinks)	 (blinks)	<ul style="list-style-type: none"> Battery is exhausted. Battery information not available. 	<ul style="list-style-type: none"> Recharge or replace with fully-charged spare battery. Battery can not be used in camera. 	12, 123 13
CLOCK (blinks)		Camera clock not set.	Set camera clock.	103
[-E-]		No memory card.	Insert memory card.	15
FULLL (blinks)	FULL (blinks)	No memory for further photos at current settings, or camera has run out of file or folder numbers.	<ul style="list-style-type: none"> Reduce image quality or size. Delete photographs. Insert new memory card. 	33 65, 74 15
	● (blinks)	Camera unable to focus using autofocus.	Recompose photo or focus manually.	22, 32
	Hi	Subject too bright; photo will be overexposed.	<ul style="list-style-type: none"> Choose lower ISO sensitivity. Increase shutter speed. Choose smaller aperture (larger f-number). Use optional Neutral Density (ND) filter. 	43 48, 50 49, 50 122
	Lo	Subject too dark; photo will be underexposed.	<ul style="list-style-type: none"> Choose higher ISO sensitivity. Decrease shutter speed. Choose larger aperture (smaller f-number). 	43 48, 50 49, 50
	 (blinks)	<ul style="list-style-type: none"> Flash required for correct exposure.  blinks for 3 s after flash fires; flash has fired at full power. 	<ul style="list-style-type: none"> Raise built-in flash. View photo; if underexposed, adjust settings and try again. 	23 26, 61
 (blinks)	 (blinks)	Optional Speedlight that does not support i-TTL set to TTL mode.	Change flash control mode for optional Speedlight.	120, 141
bulb (blinks)		"bulb" selected in mode M and mode dial rotated to S .	Change shutter speed or select mode M .	48, 50
- - (blinks)		"--" selected in mode M and mode dial rotated to S .		
Errr (blinks)		Camera malfunction.	Press shutter-release button again. If error persists, consult with Nikon-authorized service representative.	—

Indicator			Problem	Solution	
Monitor	Control panel	Viewfinder			
NO CARD PRESENT	(-E -)	 / (-E -)	No memory card.	Insert memory card.	15
CARD IS LOCKED	 / () (blinks)		Memory card is locked (write protected).	Slide card write-protect switch to “write” position.	15
THIS CARD CAN NOT BE USED	 (blinks)		<ul style="list-style-type: none"> • Error accessing memory card. • Unable to create new folder. 	<ul style="list-style-type: none"> • Use Nikon-approved card. • Card may be damaged. Contact retailer or Nikon-authorized service representative. • Delete unwanted files or insert new memory card. 	122 — 15, 65, 74
CARD IS NOT FORMATTED	 (blinks)		Memory card has not been formatted for use in D80.	Highlight Format and press OK to format memory card.	—
FOLDER CONTAINS NO IMAGES			<ul style="list-style-type: none"> • Memory card is empty. • Current folder is empty. 	<ul style="list-style-type: none"> • Insert another card. • Set Playback folder to All. 	15 75
ALL IMAGES HIDDEN			All photos in current folder are hidden.	Set Playback folder to All or use Hide image to reveal photos.	75, 77
FILE DOES NOT CONTAIN IMAGE DATA			File created or modified using computer or other make of camera, or file is corrupt.	Delete file or reformat memory card.	16, 65, 74, 102
CHECK PRINTER Continue Cancel			Printer is out of ink or ink is running low.	Replace ink. If error occurs with ink remaining in printer, check printer status.	—



Appendix

The Appendix covers the following topics:

- **Supported Standards** 134
- **Available Settings and Defaults** 134
- **Memory Card Capacity and Image Quality / Size** 138
- **Exposure Program (Mode P)** 139
- **Bracketing Programs** 140
- **White Balance and Color Temperature** 140
- **Flash Control** 141
- **Shutter Speeds Available with the Built-in Flash** 141
- **Aperture, Sensitivity, and Flash Range** 141

Supported Standards

- **DCF Version 2.0:** The Design Rule for Camera File Systems (DCF) is a standard widely used in the digital camera industry to ensure compatibility among different makes of camera.
- **DPOF:** Digital Print Order Format (DPOF) is an industry-wide standard that allows pictures to be printed from print orders stored on the memory card.
- **Exif version 2.21:** The D80 supports Exif (Exchangeable Image File Format for Digital Still Cameras) version 2.21, a standard in which information stored with photographs is used for optimal color reproduction when the images are output on Exif-compliant printers.
- **PictBridge:** A standard developed through cooperation with the digital camera and printer industries, allowing photographs to be output directly to a printer without first transferring them to a computer.

Available Settings and Defaults

The following table lists the settings that can be adjusted in each mode.

								P	S	A	M
Shooting menu	Optimize image							✓	✓	✓	✓
	Image quality ¹	✓	✓	✓	✓	✓	✓	✓	✓	✓	✓
	Image size ¹	✓	✓	✓	✓	✓	✓	✓	✓	✓	✓
	White balance ¹							✓	✓	✓	✓
	ISO sensitivity ¹	✓	✓	✓	✓	✓	✓	✓	✓	✓	✓
	Long exp. NR	✓	✓	✓	✓	✓	✓	✓	✓	✓	✓
	High ISO NR	✓	✓	✓	✓	✓	✓	✓	✓	✓	✓
	Multiple exposure ¹							✓	✓	✓	✓
Other settings	Shooting mode ¹	✓	✓	✓	✓	✓	✓	✓	✓	✓	✓
	Autofocus mode ¹	✓ ²	✓ ²	✓ ²	✓ ²	✓ ²	✓ ²	✓	✓	✓	✓
	Metering ¹							✓	✓	✓	✓
	Flexible program ¹							✓			
	Autoexposure lock ¹	✓	✓	✓	✓	✓	✓	✓	✓	✓	✓
	Exposure compensation ¹							✓	✓	✓	✓
	Bracketing ¹							✓	✓	✓	✓
	Flash mode ¹	✓ ²	✓ ²	✓ ^{2,3}	✓ ²	✓ ^{2,3}	✓ ^{2,3}	✓ ²	✓	✓	✓
Metering ¹							✓	✓	✓	✓	

1. Reset with two-button reset (44).

2. Reset with when mode dial is rotated to new setting.

3. Available with optional Speedlight only.

4. Reset with Custom Setting R (**Reset**).

								P	S	A	M
1: Beep	✓	✓	✓	✓	✓	✓	✓	✓	✓	✓	✓
2: AF-area mode	✓ ²	✓ ²	✓ ²	✓ ²	✓ ²	✓ ²	✓ ²	✓	✓	✓	✓
3: Center AF area	✓	✓	✓	✓	✓	✓	✓	✓	✓	✓	✓
4: Built-in AF assist illuminator	✓	✓		✓			✓	✓	✓	✓	✓
5: No memory card?	✓	✓	✓	✓	✓	✓	✓	✓	✓	✓	✓
6: Image review	✓	✓	✓	✓	✓	✓	✓	✓	✓	✓	✓
7: ISO auto								✓	✓	✓	✓
8: Grid display	✓	✓	✓	✓	✓	✓	✓	✓	✓	✓	✓
9: Viewfinder warning	✓	✓	✓	✓	✓	✓	✓	✓	✓	✓	✓
10: EV step	✓	✓	✓	✓	✓	✓	✓	✓	✓	✓	✓
11: Exposure comp.								✓	✓	✓	✓
12: Center-weighted								✓	✓	✓	✓
13: Auto BKT set								✓	✓	✓	✓
14: Auto BKT order								✓	✓	✓	✓
15: Command dials								✓	✓	✓	✓
16: FUNC button	✓	✓	✓	✓	✓	✓	✓	✓	✓	✓	✓
17: Illumination	✓	✓	✓	✓	✓	✓	✓	✓	✓	✓	✓
18: AE-L/AF-L	✓	✓	✓	✓	✓	✓	✓	✓	✓	✓	✓
19: AE lock	✓	✓	✓	✓	✓	✓	✓	✓	✓	✓	✓
20: Focus area	✓	✓	✓	✓	✓	✓	✓	✓	✓	✓	✓
21: AF area illumination	✓	✓	✓	✓	✓	✓	✓	✓	✓	✓	✓
22: Built-in flash								✓	✓	✓	✓
23: Flash warning								✓	✓	✓	✓
24: Flash shutter speed								✓	✓	✓	✓
25: Auto FP								✓	✓	✓	✓
26: Modeling flash								✓	✓	✓	✓
27: Monitor off	✓	✓	✓	✓	✓	✓	✓	✓	✓	✓	✓
28: Auto meter off	✓	✓	✓	✓	✓	✓	✓	✓	✓	✓	✓
29: Self timer	✓	✓	✓	✓	✓	✓	✓	✓	✓	✓	✓
30: Remote	✓	✓	✓	✓	✓	✓	✓	✓	✓	✓	✓
31: Exposure delay mode	✓	✓	✓	✓	✓	✓	✓	✓	✓	✓	✓
32: MB-D80batteries	✓	✓	✓	✓	✓	✓	✓	✓	✓	✓	✓

Custom Settings⁴



The following defaults are restored when a two-button reset is performed:

	AUTO							P	S	A	M	
Shooting menu	Image quality	JPEG Normal										
	Image size	L (3872×2592)										
	White balance	—							Auto			
	Fine tuning	—							0			
	Choose color temp.	—							5,000 K			
	ISO sensitivity	AUTO							100			
Multiple exposure	—							Off				
Other settings	Shooting mode	Single frame										
	Focus area	—	Center		—		Center					
	Focus lock	Off										
	AE lock hold	Off										
	Autofocus mode	AF-A										
	Metering	—							Matrix			
	Flexible program	—							Off	—		
	Exposure compensation	—							Off (0.0)			
	Bracketing	—							Off (0 frames)			
	Flash mode	Auto	—	Auto	—	Slow ¹		Fill flash				
	Flash compensation	—							Off (0.0)			
FV lock	—							Off				

1. Auto slow sync.

The following defaults are restored with Custom Setting R (**Reset**):

		AUTO								P	S	A	M	
1: Beep		On												
2: AF-area mode		Auto-area AF	Single	Dynamic	Auto-area AF	Single area								
3: Center AF area		Normal frame												
4: Built-in AF assist illuminator		On	—	On	—	On								
5: No memory card?		Release locked												
6: Image review		On												
7: ISO auto		—							Off ¹					
8: Grid display		Off												
9: Viewfinder warning		On												
10: EV step		1/3 step												
11: Exposure comp.		—							Off					
12: Center-weighted		—							ø8 mm					
13: Auto BKT set		—							AE & flash					
14: Auto BKT order		—							MTR > Under > over					
15: Command dials		—							Off					
16: FUNC button		ISO display												
17: Illumination		Off												
18: AE-L/AF-L		AE/AF lock												
19: AE lock		Off												
20: Focus area		No wrap												
21: AF area illumination		Auto												
22: Built-in flash		—							TTL					
23: Flash warning		—							On					
24: Flash shutter speed		—							1/60					
25: Auto FP		Off												
26: Modeling flash		—							Off					
27: Monitor off		20 s												
28: Auto meter off		6 s												
29: Self timer		10 s												
30: Remote		1 min.												
31: Exposure delay mode		Off												
32: MB-D80 batteries		LR6 (AA-size alkaline)												

Custom Settings

1. **Max. sensitivity** set to 800, **Min. shutter speed** set to 1/30.

Memory Card Capacity and Image Quality / Size

The following table shows the approximate number of pictures that can be stored on a 1 GB Panasonic Pro HIGH SPEED card at different image quality and size settings.

Image quality	Image size	File size (MB) ¹	Number of images ¹	Buffer capacity ^{1,2}
NEF + JPEG Fine ³	L	17.2	54	6
	M	15.1	63	6
	S	13.6	72	6
NEF + JPEG Normal ³	L	14.8	65	6
	M	13.8	71	6
	S	13.0	76	6
NEF + JPEG Basic ³	L	13.6	72	6
	M	13.0	76	6
	S	12.7	78	6
NEF (RAW)	—	12.4	82	6
JPEG Fine	L	4.8	133	23
	M	2.7	233	100
	S	1.2	503	100
JPEG Normal	L	2.4	260	100
	M	1.3	446	100
	S	0.6	918	100
JPEG Basic	L	1.2	503	100
	M	0.7	876	100
	S	0.3	1500	100

1. All figures are approximate. File size varies with scene recorded and make of memory card.

2. Maximum number of frames that can be taken before shooting stops at ISO 100. Capacity of memory buffer drops if noise reduction is on.

3. Image size applies to JPEG images only. Size of NEF (RAW) images can not be changed. File size is the total for compressed NEF (RAW) and JPEG images.

Exposure Program (Mode P)

The exposure program for mode P is shown in the following graph.

- F (lens focal length) \leq 55 mm
- 135 mm \geq F $>$ 55 mm
- - - F $>$ 135 mm

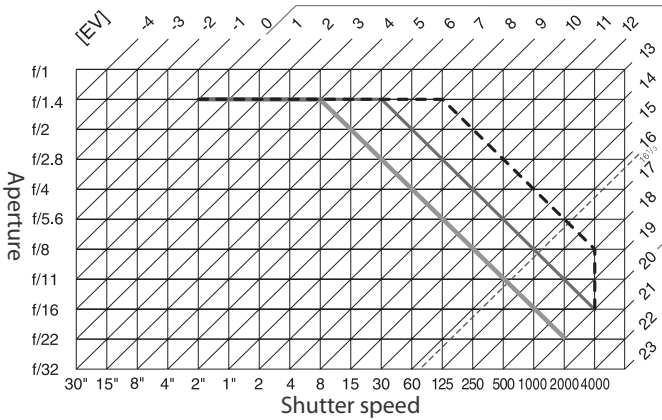

The maximum and minimum values for EV vary with ISO sensitivity; the above graph assumes an ISO sensitivity of ISO 200 equivalent. When matrix metering is used, values over $16 \frac{1}{3}$ EV are reduced to $16 \frac{1}{3}$ EV.



Bracketing Programs

The number of shots and bracketing increment are shown in the control panel as follows:

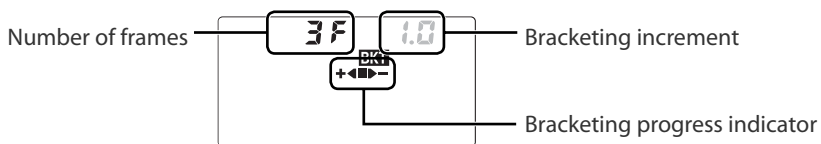

The Bracketing Progress Indicator and Number of Frames

Number of frames	Progress indicator	Description
3F	+◀▶-	3 frames: unmodified, negative, positive*
+2F	+◀■	2 frames: unmodified, negative*
--2F	■▶-	2 frames: unmodified, positive

* Order when **Under > MTR > over** is selected for Custom Setting 14 (**Auto BKT order**) is negative, unmodified, positive (three frames) or negative, unmodified (two frames).

Bracketing Increment

Autoexposure and flash bracketing				White balance bracketing	
Custom Setting 10 (EV Step) set to 1/3 EV		Custom Setting 10 (EV Step) set to 1/2 EV		Display	Increment
Display	Increment	Display	Increment	Display	Increment
0.3	1/3 EV	0.5	1/2 EV	1	1
0.7	2/3 EV	1.0	1 EV	2	2
1.0	1 EV	1.5	1 1/2 EV	3	3
1.3	1 1/3 EV	2.0	2 EV		
1.7	1 2/3 EV				
2.0	2 EV				

White Balance and Color Temperature

Approximate color temperatures for each white balance setting are given below (values may differ from color temperatures given by photo color meters):

White balance	Fine tuning						
	None	-3	-2	-1	+1	+2	+3
A Auto	3,500 K–8,000 K	Fine tuning added to value selected by camera					
Incandescent	3,000 K	3,300 K	3,200 K	3,100 K	2,900 K	2,800 K	2,700 K
Fluorescent*	4,200 K	7,200 K	6,500 K	5,000 K	3,700 K	3,000 K	2,700 K
Dir. sunlight	5,200 K	5,600 K	5,400 K	5,300 K	5,000 K	4,900 K	4,800 K
Flash	5,400 K	6,000 K	5,800 K	5,600 K	5,200 K	5,000 K	4,800 K
Cloudy	6,000 K	6,600 K	6,400 K	6,200 K	5,800 K	5,600 K	5,400 K
Shade	8,000 K	9,200 K	8,800 K	8,400 K	7,500 K	7,100 K	6,700 K
Choose color temp.	2,500 K–9,900 K	Not available					
PRE White balance preset	—						

* Color temperature range reflects wide variation among fluorescent light sources, ranging from low-temperature stadium lighting to high-temperature mercury-vapor lamps.

Flash Control 42, 120



The following types of flash control are supported when a CPU lens is used in combination with the built-in flash or optional SB-800 or SB-600 Speedlights.

- **i-TTL Balanced Fill-Flash for Digital SLR:** Flash output is adjusted for a natural balance between the main subject and the background.
- **Standard i-TTL Fill-Flash for Digital SLR:** Flash output is adjusted for the main subject; the brightness of the background is not taken into account. Recommended for shots in which the main subject is emphasized at the expense of background details, or when exposure compensation is used.

Standard i-TTL flash control is used with spot metering or when selected with the optional Speedlight. i-TTL balanced fill-flash for digital SLR is used in all other cases.

Shutter Speeds Available with the Built-in Flash

The following shutter speeds are available when the built-in flash is used.

Mode	Shutter speed	Mode	Shutter speed
AUTO,  , P*, A*	1/200–1/60 S		1/200–1 s
	1/200–1/125 S	S, M	1/200–30 s



* Slowest shutter speed at which flash will be used can be selected using Custom Setting 24 (**Flash shutter speed**). Flash will still fire at shutter speeds as slow as 30 s when set to slow sync.

Aperture, Sensitivity, and Flash Range

Flash range varies with sensitivity (ISO equivalency) and aperture.

Aperture at ISO equivalent of													Range	
100	125	160	200	250	320	400	500	640	800	1000	1200	1600	m	ft.
1.4	1.6	1.8	2	2.2	2.5	2.8	3.2	3.5	4	4.5	5	5.6	1.0–9.2	3 ft. 3 in.–30 ft. 2in.
2	2.2	2.5	2.8	3.2	3.5	4	4.5	5	5.6	6.3	7.1	8	0.7–6.5	2 ft. 4 in.–21 ft. 4in.
2.8	3.2	3.5	4	4.5	5	5.6	6.3	7.1	8	9	10	11	0.6–4.6	2 ft.–15 ft. 1in.
4	4.5	5	5.6	6.3	7.1	8	9	10	11	13	14	16	0.6–3.2	2 ft.–10 ft. 6in.
5.6	6.3	7.1	8	9	10	11	13	14	16	18	20	22	0.6–2.3	2 ft.–7 ft. 7in.
7	9	10	11	13	14	16	18	20	22	25	29	32	0.6–1.6	2 ft.–5 ft. 3in.
11	13	14	16	18	20	22	25	29	32	—	—	—	0.6–1.1	2 ft.–3 ft. 7in.
16	18	20	22	25	29	32	—	—	—	—	—	—	0.6–0.8	2 ft.–2 ft. 7in.

In the following modes, the maximum aperture (minimum f-number) is limited according to ISO sensitivity when the built-in flash is used:

Mode	Maximum aperture at ISO sensitivity of													
	100	125	160	200	250	320	400	500	640	800	1000	1250	1600	
P, AUTO,  , 	4	4.2	4.5	4.8	5	5.3	5.6	6	6.3	6.7	7.1	7.6	8	
	5.6	6	6.3	6.7	7.1	7.6	8	8.5	9	9.5	10	11	11	

For each one-step increase in sensitivity (e.g., from 200 to 400), aperture is stopped down by half an f-stop. If the maximum aperture of the lens is smaller than given above, the maximum value for aperture will be the maximum aperture of the lens.

Specifications

Type	Single-lens reflex digital camera
Effective pixels	10.2 million
CCD	23.6 × 15.8 mm; total pixels: 10.75 million
Image size (pixels)	• 3,872 × 2,592 (Large) • 2,896 × 1,944 (Medium) • 1,936 × 1,296 (Small)
Lens mount	Nikon F mount with AF coupling and AF contacts
Compatible lenses*	
Type G or D Nikkor	All functions supported
PC-Micro Nikkor 85 mm f/2.8D	All functions supported except autofocus and some exposure modes
Other AF Nikkor †	All functions supported except 3D color matrix metering II
AI-P Nikkor	All functions supported except 3D color matrix metering II and autofocus
Non-CPU	Can be used in mode M , but exposure meter does not function; electronic rangefinder can be used if maximum aperture is f/5.6 or faster.

* IX-Nikkor lenses can not be used

† Excluding lenses for F3AF

Picture angle	Equivalent in 35mm (135) format is approx. 1.5 times lens focal length.
Viewfinder	Optical fixed eye-level pentaprism
Diopter	-2.0 to +1.0 m ⁻¹
Eyepoint	19.5 mm (-1.0 m ⁻¹)
Focusing screen	Type-B BriteView Clear Matte Screen Mark II with superimposed focus brackets and On-Demand grid lines
Frame coverage	Approx. 95% of lens (vertical and horizontal)
Magnification	Approx. 0.94 × (50 mm lens at infinity; -1.0 m ⁻¹)
Reflex mirror	Quick return
Lens aperture	Instant return with depth-of-field preview
Depth-of-field preview	When CPU lens is attached, depth-of-field preview button stops aperture down to value selected by user (A and M modes) or by camera (other modes)
Self-timer	Electronically controlled timer with 2, 5, 10 or 20 s duration
Focus-area selection	Focus area can be selected from 11 focus areas
Lens servo	<ul style="list-style-type: none"> • Autofocus (AF): Instant single-servo AF (AF-S); continuous-servo AF (AF-C); auto AF-S/AF-C selection (AF-A); predictive focus tracking activated automatically according to subject status • Manual focus (M)
Storage	
Media	SD (Secure Digital) memory cards; camera supports SDHC
File system	Compliant with Design Rule for Camera File System (DCF) 2.0 and Digital Print Order Format (DPOF)
Compression	• NEF (RAW) : compressed 12-bit • JPEG : JPEG baseline-complaint
Autofocus	TTL phase detection by Nikon Multi-CAM 1000 autofocus sensor module
Detection range	-1.0 to +19 EV (ISO 100 at 20°C/68°F)
AF-area mode	Single-area AF, dynamic-area AF, auto-area AF
Focus lock	Focus can be locked by pressing the shutter-release button halfway (single-servo AF) or by pressing the AE-L/AF-L button
ISO sensitivity (Recommended Exposure Index)	100 to 1600 with additional settings of up to 1 EV over 1600 in steps of 1/3 EV

Exposure	
Metering	Three-mode through-the-lens (TTL) exposure metering
Matrix	3D color matrix metering II (type G and D lenses); color matrix metering II (other CPU lenses); metering performed by 420-segment RGB sensor
Center-weighted	Weight of 75% given to 6, 8, or 10 mm circle in center of frame
Spot	Meters 3.5 mm circle (about 2.5% of frame) centered on active focus area
Range (ISO 100 equivalent, f/1.4 lens, 20 °C/68 °F)	0 to 20 EV (3D color matrix or center-weighted metering) 2 to 20 EV (spot metering)
Exposure meter coupling	CPU coupling
Mode	Digital Vari-Program (📷 auto, 📷 portrait, 📷 landscape, 📷 macro close-up, 📷 sports, 📷 night landscape, 📷 high portrait); programmed auto (P) with flexible program; shutter-priority auto (S); aperture-priority auto (A); manual (M)
Exposure compensation	-5 to +5 EV in increments of 1/3 or 1/2 EV
Bracketing	Exposure and / or flash bracketing (2-3 exposures in increments of 1/3 or 1/2 EV)
Exposure lock	Exposure locked at detected value with AE-L/AF-L button
Shutter	
Speed	Electronically-controlled vertical-travel focal plane shutter 30 to 1/4,000 s in steps of 1/3 or 1/2 EV, bulb
White balance	
Bracketing	Auto (TTL white balance with 420-segment RGB sensor); six manual modes with fine tuning; color temperature setting; preset white balance 2 to 3 exposures in increments of 1
Built-in flash	
Guide number (m/ft)	<ul style="list-style-type: none"> • 📷, 📷, 📷, 📷: Auto flash with auto pop-up • P, S, A, M: Manual pop-up with button release Approx. 13/42 at ISO 100 and 20 °C (68 °F)
Flash	
Sync contact	X-contact only; flash synchronization at shutter speeds of up to 1/200 s
Flash control	
TTL	TTL flash control by 420-segment RGB sensor. i-TTL balanced fill-flash for digital SLR and standard i-TTL fill-flash for digital SLR available with built-in flash, SB-800, and SB600.
Auto aperture	Available with SB-800 and CPU lens
Non-TTL auto	Available with such Speedlights as SB-800, 80DX, 28DX, 28, 27, and 22s
Range-priority manual	Available with SB-800
Flash mode	<ul style="list-style-type: none"> • 📷, 📷, 📷, 📷: Auto, auto with red-eye reduction; fill-flash and red-eye reduction available with optional Speedlight • 📷: Auto, auto slow sync, auto slow sync with red-eye reduction; slow sync and slow sync with red-eye reduction available with optional Speedlight • 📷, 📷: Fill-flash and red-eye reduction available with optional Speedlight • P, A: Fill flash, rear-curtain with slow sync, slow sync, slow sync with red-eye reduction, red-eye reduction • S, M: Fill flash, rear-curtain sync, red-eye reduction
Flash-ready indicator	Lights when built-in flash or SB-series Speedlight such as 800, 600, 80DX, 28DX, 50DX, 28, 27, or 22s is fully charged; blinks for about 3 s after flash is fired at full output
Accessory shoe	Standard ISO hot-shoe contact with safety lock
Nikon Creative Lighting System	With SB-800, 600, and R200, supports Advanced Wireless Lighting (SB-600 and R200 only support AWL when used as remote flash), Auto FP High-Speed Sync, Flash Color Information Communication, modeling Flash, and FV Lock.
Monitor	2.5 in., 230,000-dot, low-temperature polysilicon TFT LCD with brightness adjustment
Video output	Can be selected from NTSC and PAL
External interface	USB 2.0 Hi-speed
Tripod socket	1/4 in. (ISO)

Firmware upgrades	Firmware can be upgraded by user
Supported languages	Chinese (Simplified and Traditional), Dutch, English, Finnish, French, German, Italian, Japanese, Korean, Polish, Portuguese, Russian, Spanish, Swedish
Power source	<ul style="list-style-type: none"> • One rechargeable Nikon EN-EL3e Li-ion battery; charging voltage (MH-18a quick charger): 7.4 V DC • MB-D80 Multi-Power battery pack (available separately) with one or two rechargeable Nikon EN-EL3e Li-ion batteries or six LR6 alkaline, HR6 Ni-MH, FR6 lithium, or ZR6 nickel manganese AA batteries • EH-5/EH-5a AC adapter (available separately)
Dimensions (W × D × H)	Approx. 132 × 103 × 77 mm (5.2 × 4.1 × 3.0 in.)
Weight	Approx. 585 g (1 lb. 5 oz.) without battery, memory card, body cap, or LCD monitor cover
Operating environment	
Temperature	0 to +40 °C (+32 to 104 °F)
Humidity	Less than 85% (no condensation)

Unless otherwise stated, all figures are for a camera with a fully-charged battery operating at an ambient temperature of 20 °C (68 °F).

MH-18a Quick Charger

Rated input	AC 100 to 240 V, 50/60 Hz
Rated output	DC 8.4 V / 900 mA
Supported batteries	EN-EL3e rechargeable Li-ion batteries
Charging time	Approx. 135 minutes
Operating temperature	0 to +40 °C (+32 to 104 °F)
Dimensions (W × D × H)	Approx. 90 × 35 × 58 mm (3.5 × 1.4 × 2.3 in.)
Length of cord	Approx. 1,800 mm (5 ft. 11 in.)
Weight	Approx. 80 g (2.8 oz.), excluding power cable

EN-EL3e Rechargeable Li-ion Battery

Type	Rechargeable lithium-ion battery
Rated capacity	7.4 V / 1500 mAh
Dimensions (W × D × H)	Approx. 39.5 × 56 × 21 mm (1.6 × 2.2 × 0.8 in.)
Weight	Approx. 80 g (2.8 oz.), excluding power cable

Specifications

Nikon reserves the right to change the specifications of the hardware and software described in this manual at any time and without prior notice. Nikon will not be held liable for damages that may result from any mistakes that this manual may contain.

18–135 mm f/3.5–5.6G ED AF-S DX Zoom-Nikkor Lens (Available Separately)

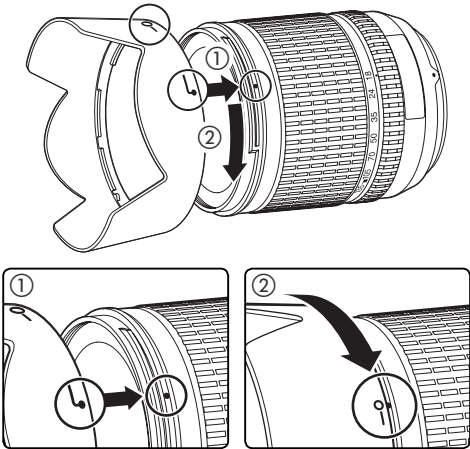
Type	G-type AF-S DX Zoom-Nikkor lens with built-in CPU and Nikon mount
Supported cameras	Nikon DX format digital cameras
Focal length	18–135 mm
Max. aperture	1 : 3.5–5.6
Construction	15 elements in 13 groups (including 1 ED glass element and 2 aspherical elements)
Focal length scale	18, 24, 35, 50, 70, 105, 135
Distance information	Supplied to camera body
Zoom	Zoom adjusted by rotating zoom ring
Focus	Autofocus with Silent Wave Motor; manual focus; manual focus supported when A-M switch set to A or M. Focus can be adjusted by rotating lens focusing ring after locking focus in single-servo autofocus. Do not use focusing ring while camera is focusing.
Closest focus distance	0.45 m (1.5 ft.) at all zoom positions
Aperture	Seven blade diaphragm with auto aperture
Aperture range	f/3.5–22 (at 18 mm); f/5.6–38 (at 135 mm)
Metering	Maximum aperture
Filter diameter	67 mm (P=0.75 mm)
Dimensions (W × D × H)	Approx. 73.5 mm diameter × 86.5 mm/2.9 × 3.4 in.
Weight	Approx. 385 g (13.6 oz.)
Lens hood	HB-32 (available separately; attaches as shown below) 

The following accessories can not be used with the 18–135 mm f/3.5–5.6G ED AF-S DX: teleconverters (all types), PK auto extension rings (all types), K rings (all types), BR-4 auto rings, bellows attachments (all types), and SX-1 attachment rings. Other accessories may also be incompatible. See the accessory manual for details.

Battery Life

The number of shots that can be taken with a fully-charged EN-EL3e battery (1500 mAh) varies with the condition of the battery, temperature, and how the camera is used. The following measurements were performed at a temperature of 20°C (68°F).

Example 1: 2,700 shots

AF-S DX 18–135 mm f/3.5–5.6G ED lens; continuous shooting mode; continuous-servo autofocus; image quality set to JPEG Basic; image size set to **M**; shutter speed 1/250 s; shutter-release button pressed halfway for three seconds and focus cycled from infinity to minimum range three times; after six shots, monitor turned on for five seconds and then turned off; cycle repeated once exposure meters have turned off.

Example 2: 600 shots

AF-S DX 18–135 mm f/3.5–5.6G ED lens; single-frame shooting mode; continuous-servo autofocus; image quality set to JPEG Normal; image size set to **L**; shutter speed 1/250 s; shutter-release button pressed halfway for five seconds and focus cycled from infinity to minimum range once; monitor turned on for four seconds after each shot; built-in Speedlight fired at full power with every other shot; next shot taken after exposure meters have turned off.

The following can reduce battery life:

- Using the monitor
- Keeping the shutter-release button pressed halfway
- Repeated autofocus operations
- Taking RAW (NEF) photographs
- Slow shutter speeds















To ensure maximum battery performance:

- Keep the battery contacts clean. Soiled contacts can reduce battery performance.
- Use EN-EL3e batteries immediately after charging. Batteries will lose their charge if left unused.
- Check battery status regularly using the **Battery info** option in the setup menu ( 107).

The battery level displayed by the camera may vary with changes in temperature.

Index

Symbols

- 3D color matrix metering II. See Metering
- 420-segment RGB sensor. See Metering; White balance
-  (auto mode), 19–23
-  (close-up mode), 24–25
-  (continuous shooting indicator), 36
-  (exposure compensation), 54
-  (flash compensation), 55
-  (flash-ready indicator), 23
-  (FV lock), 92–93
-  (landscape mode), 24–25
-  (night landscape mode), 24–25
-  (night portrait mode), 24–25
-  (portrait mode), 24–25
-  (remote control indicator), 38–39
-  (self timer indicator), 37
-  (sports mode), 24–25

A

- A**. See Aperture-priority auto
- Accessories. See also Battery; Lens; Flash, optional
 - optional, 116–123
 - supplied, 7
- Adobe RGB. See Color mode
- Advanced Wireless Lighting, 120
- AE-L/AF-L** (Custom Settings menu), 94
- AE lock** (Custom Settings menu), 94
- AF-A. See Focus, autofocus, mode
- AF area illumination** (Custom Settings menu), 95
- AF-area mode** (Custom Settings menu), 87
- AF-assist illuminator, 28, 87
- AF-C. See Focus, autofocus, mode
- AF-S. See Focus, autofocus, mode
- Aperture, 49–50, 141
 - maximum, 49, 50, 116, 121
 - minimum, 45, 49, 50, 132
- Aperture-priority auto, 49
- Audio/video (AV) cable, 66
- Auto-area AF. See **AF-area mode**
- Auto BKT order** (Custom Settings menu), 91

- Auto BKT set** (Custom Settings menu), 90
- Autoexposure lock, 53. See also **AE lock**
- Autofocus. See Focus
- Auto (Flash mode), 41
- Auto FP** (Custom Settings menu), 98
- Auto image rotation** (setup menu), 108
- Auto meter off, 18, 99
- Auto meter off** (Custom Settings menu), 99
- Auto mode, 19–23

B

- Backlight, control panel, 3, 93
- BASIC. See Image quality
- Battery, 7, 12–13, 19, 123, 127. See also **Battery info**; Clock, battery; MB-D80
 - EN-EL3e, 7, 12–13, 123
 - inserting, 12–13
 - life, 146
 - storage, ii, 127

- Battery info** (setup menu), 107

- Beep** (Custom Settings menu), 86

- BKT** (bracketing indicator), 56–57

- Black and white, 81

- Blur, reducing, 36, 51. See also **Exposure delay mode**;

- Self timer; Shooting mode, delayed remote; Shooting mode, quick-response remote

- Bracketing, 56–57, 140. See also Exposure, bracketing;

- Flash, bracketing; White balance, bracketing

- Brightness. See Exposure; Flash, level; **LCD brightness**;

- Monitor, brightness of
- Buffer size, 36

- Built-in AF-assist illuminator** (Custom Settings menu), 87

- Built-in flash** (Custom Settings menu), 40, 95

- Bulb. See Long time-exposures

- Burst. See Shooting mode, continuous

- B/W. See Black and white

C

- Camera Control Pro, 68, 123

- Capture NX, 106, 123

- Center AF area** (Custom Settings menu), 87

- Center-weighted. See **Center-weighted**; Metering

- Center-weighted** (Custom Settings menu), 90

- Clock, 103, 132
 - battery, 103

- CLOCK** (“clock not set” indicator), 103, 132

- Close up, 24–25

- CLS. See Creative Lighting System

- Color. See Color mode; **Filter effects**; Hue; Saturation; White balance

- Color mode, 80

- Color profile. See Color mode

- Color space. See Color mode

- Color temperature, 58, 59, 140. See also White balance

- Command dials** (Custom Settings menu), 91

- Computer, 67–68, 69

- Continuous, 36

- Continuous-servo AF. See

- Focus, autofocus, mode

- Contrast, 79–80. See also

- Optimize image**; Tone compensation

- Copies. See **Small picture**

- CPU lens. See Lens, CPU

- Creative Lighting System

- (CLS), 119, 121

- Crop, 71, 111. See also Printing;

- Trim**

- CSM/Setup menu** (setup

- menu), 101–102

- Custom Settings, 86–100

D

- Date, 14, 103. See also Clock;

- World time**

- Daylight saving time, 103. See

- also **World time**

- DCF. See Design Rule for

- Camera File System

- DC-IN, 9

- Default settings, 134–137. See

- also **Reset**; Two-button reset

- Delete, 26, 65, 74. See also

- Memory card, formatting;

- Protecting photographs

- all images, 74

- selected images, 74

- single-frame playback,

- 26, 65

- Delayed remote, 36, 38

- Delete** (playback menu), 74
- Depth of field, 49

- preview, 49. See also **Modeling flash**

- Design Rule for Camera File System, 134

- Digital Print Order Format, 69, 73, 134

- Digital Vari-Program, 24–25

- Diopter, 17, 122. See also

- Viewfinder

- D-lighting, 110

- D-lighting** (retouch menu), 110

- DPOF. See Digital Print Order Format

- Dust off ref photo** (setup menu), 106–107

- Dynamic area AF. See **AF-area mode**

E

- Electronic rangefinder. See Focus, manual

- EV step** (Custom Settings menu), 89

- Exif version 2.21, 134

- Exposure, 52–57, 89. See also

- Aperture; Aperture-priority auto; Autoexposure lock;

- Programmed auto; Shutter-priority auto; Shutter speed;

- Manual mode

- bracketing, 56–57, 140

- compensation, 54, 55, 89

- electronic analog exposure display, 50

- meters, 3, 18, 99

- program, 139

- Exposure comp.** (Custom Settings menu), 89

- Exposure delay mode** (Custom Settings menu), 99

- Eyepiece cap, 3, 8, 37

F

- File, 33, 35, 77, 106, 138

- format, 35, 77, 134

- File no. sequence** (setup menu), 106

- Filter. See also Accessories, optional; **Filter effects**;

- Neutral Density (ND)

- Filter effects** (retouch

- menu), 112

- Firmware. See **Firmware version**

Firmware version (setup menu), 108

FINE. See **Image quality**
Flash

- bracketing, 56–57
- built in, 23, 40–42, 95
- compensation, 55
- level, 42, 90, 92
- monitor preflash, 93, 95–97
- optional, 119–121
- range, 23, 119, 141
- ready indicator, 23, 93, 121
- remote, 119
- sync speed, 42

Flash mode, 40–42

Flash shutter speed (Custom Settings menu), 98

Flash warning (Custom Settings menu), 98

Flexible program. See **Programmed auto**

Focus, 28–32. See also **AF-area mode**

- area, 30, 32, 87
- center, 30, 87
- autofocus, 28–31
- lock, 31
- mode, 29–30
- manual, 32
- tracking, 24

Focus area (Custom Settings menu), 94

Folder, 75, 102

- playback, 75
- recording, 105

Folders (setup menu), 105

Format (setup menu), 102

Framing grid, 6. See also **Grid display**

Front-curtain sync, 42

FUNC button (Custom Settings menu), 92–93

FV lock, 92–93

G

Grid display (Custom Settings menu), 89

H

Hide image (playback menu), 78

Hiding images. See **Hide image**

High ISO NR (shooting menu), 83

Highlights, 63

Histogram, 63

Hue, 80

I

Illumination (Custom Settings menu), 93

Illuminator. See **Backlight**, **control panel**; **AF-assist illuminator**

Image comment (setup menu), 104

Image overlay (retouch menu), 114–115

Image quality, 34

- NEF (RAW), 34, 35, 69, 114–115

Image quality (shooting menu), 81

Image review (Custom Settings menu), 88

Image sensor, 34, 46, 106, 125

- dimensions of, 142

Image size, 35

Image size (shooting menu), 81

ISO auto (Custom Settings menu), 88

ISO sensitivity, 43

- auto, 43, 88

ISO sensitivity (shooting menu), 83

i-TTL flash control, 96, 119–121, 141

J



JPEG, 33, 35, 69, 138

K

K. See **Color temperature**; **Number of exposures remaining**

L

L. See **Image size**

Landscapes. See  (landscape mode);  (night landscape mode)

Language, 14, 103

Language (setup menu), 103

LCD brightness (setup menu), 103

Lens, 11, 21, 116–117

- CPU, 117
- type D, 117
- type G, 117
- non-CPU, 118

Lighting. See **Flash**; **White balance**

Long exp. NR (shooting menu), 83

Long time-exposures, 51, 123

Low-pass filter, 125–126

- cleaning, 125–126

M

M. See **Image size**

M. See **Manual mode**

- Manual mode, 45, 50–51

MB-D80, 100, 107, 123

MB-D80 batteries (Custom Settings menu), 100

Mass storage. See **USB**, **Mass storage**

Matrix. See **Metering**

Memory buffer, 36, 83, 138

Memory card, 15–16, 122, 138

- approved, 122
- capacity, 138
- formatting, 16, 102
- lock, 15

Menus, 74–114. See also **CSM/Setup menu**

using, 9–10

Metering, 52

Mirror, 16, 106, 124, 125–126

Mirror lock-up (setup menu), 106

Mode, 45–51. See also **Aperture-priority auto**; **Auto mode**; **Digital Vari-Program**; **Programmed auto**; **Manual mode**; **Shutter-priority auto**

Modeling flash (Custom Settings menu), 98

Monitor, 8, 9, 61, 124

auto off, 98

brightness of, 103

cover, 8

Monitor off (Custom Settings menu), 98

Monochrome, 112. See also **Black and white**

Monochrome (retouch menu), 112

Moving subjects. See  (sports mode); **Focus**, **autofocus**, **mode**

MTP/PTP. See **USB**, **MTP/PTP**

Multiple exposure, 84–85



Multiple exposure (shooting menu), 84–85

N

ND. See **Filter**, **Neutral Density (ND)**

NEF (RAW). See **Image quality**, **NEF (RAW)**

Neutral Density. See **Filter**, **Neutral Density (ND)**

Night photography. See  (night landscape mode);  (night portrait mode)

Nikon Transfer, 67–68

Noise, 43, 51, 83, 88. See also **High ISO NR**; **Long exp. NR**

No memory card? (Custom Settings menu), 88

Non-CPU lens. See **Lens**, **non-CPU**

NORMAL. See **Image quality**

NTSC. See **Video mode**

Number of exposures remaining, 5, 16, 19, 91

O

Off (Flash mode), 41

Optimize image (shooting menu), 79–81

Options. See **Accessories**, **optional**

P

P. See **Programmed auto**

- PictBridge, 69, 71–73, 78, 134
- Pictmotion, 75–77



Picture Transfer Protocol. See **USB**, **MTP/PTP**

 (flexible program indicator), 47

Playback, 26, 61–73, 74–78

- full frame, 26, 61
- menu, 74–78
- thumbnail, 63
- zoom, 64

Playback folder (playback menu), 75

Portraits. See  (portrait mode);  (night portrait mode); **Optimize image**

PRE. See **White balance**, **preset**

Printing, 69–73. See also **PictBridge**; **Print set**

Print set (playback menu), 78

- Programmed auto, 47
- Protecting photographs, 65

Q

Quality. See **Image quality**

Quick-response remote, 36, 38

R

RAW. See **Image quality**, **NEF (RAW)**

Rear-curtain sync, 41

Red eye correction (retouch menu), 111

Red-eye reduction, 41

Remote. See **Accessories**, **optional**; **Shooting mode**, **delayed remote**; **Shooting mode**, **quick-response remote**

Remote cord, 123

Remote (Custom Settings menu), 99

Reset. See **Default settings**; **Reset**; **Two-button reset**

Reset (Custom Settings menu), 86

Retouch menu, 109–115

Rotate tall (playback menu), 75

Rotating photographs, 75, 108

S

S. See Image size

S. See Shutter-priority auto

S (single-frame shooting indicator), 36

Saturation, 80

SD. See Memory card

Secure Digital. See Memory card

Self timer, 36, 99

Self timer (Custom Settings menu), 99

Self-portraits. See Self timer

Sensitivity. See ISO sensitivity

Sepia. See **Monochrome**

Setup menu, 101–108

Sharpening, 80

Shooting menu, 79–85

Shooting mode, 36–39

- continuous, 36
- delayed remote, 38
- quick-response remote, 38
- self timer, 37
- single frame, 36

Shutter, 22, 48

- speed, 48, 50–51. See also Exposure

Shutter-priority auto, 48

Single area AF. See **AF-area mode**

Single frame, 36

Single-servo autofocus. See Focus, autofocus, mode

Size. See Image size

Slide show. See **Slide show**

Slide show (playback menu), 75–77

Slow sync, 41

Small picture (retouch menu), 112–113

Software Suite, 67

Speedlight. See Flash

Spot. See Metering

sRGB. See Color mode

T

Television, 66

Time, 14, 103. See also Clock;

World time

Time exposure. See Long time exposures

Thumbnail. See Playback, thumbnail

TTL. See **Built-in flash**

Tone compensation, 80

Trim (retouch menu), 111

Two-button reset, 44

U

USB, 67–68, 70, 104

- cable, 67, 70
- Mass storage, 67–68, 70, 104

MTP/PTP, 67–68, 70, 104

USB (setup menu), 104

V

Video device, 66

Video mode (setup menu), 103

VIDEO OUT, 66

Viewfinder, 6, 8, 17, 22, 89,

122. See also **Viewfinder**

warning

- accessories, 122

- focus, 17

- indicators, 6

Viewfinder warning (Custom Settings menu), 89

Viewing photographs. See

Playback

ViewNX, 34, 69, 108

W

WB (white balance indicator), 58–60

White balance, 58–60, 82. See

also Color temperature

- bracketing, 90

- preset, 59–60, 82

White balance (shooting menu), 82

World time (setup menu), 103



Nikon

No reproduction in any form of this manual, in whole or in part (except for brief quotation in critical articles or reviews), may be made without written authorization from NIKON CORPORATION.

NIKON CORPORATION

Fuji Bldg., 2-3 Marunouchi 3-chome,
Chiyoda-ku, Tokyo 100-8331, Japan

Printed in Europe
SB7L05(11)
6MBA6811-05