

Nikon

DIGITAL CAMERA

D3300

User's Manual

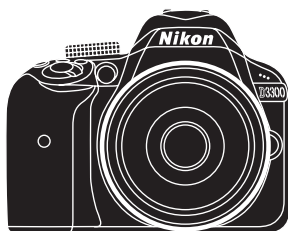

Nikon Manual Viewer 2

Use the Nikon Manual Viewer 2 app to view manuals anytime, anywhere on your smartphone or tablet.

En

For a complete guide to using your camera, see the *Reference Manual* (□ iv). To get the most from your camera, please be sure to read this *User's Manual* thoroughly and keep it where it will be read by all who use the product.

Symbols and Conventions

To make it easier to find the information you need, the following symbols and conventions are used:



This icon marks cautions; information that should be read before use to prevent damage to the camera.



This icon marks notes; information that should be read before using the camera.



This icon marks references to other pages in this manual.

Menu items, options, and messages displayed in the camera monitor are shown in **bold**.

Camera Settings

The explanations in this manual assume that default settings are used.

Nikon Manual Viewer 2



Install the Nikon Manual Viewer 2 app on your smartphone or tablet to view Nikon digital camera manuals, anytime, anywhere. Nikon Manual Viewer 2 can be downloaded free of charge from the App Store and Google Play. Download of the app and any product manuals requires an Internet connection, for which fees may be levied by your phone or Internet service provider.

For Your Safety

Before using the camera for the first time, read the safety instructions in "For Your Safety" (□ viii–xi).

Package Contents

Confirm that the package contains the following items:

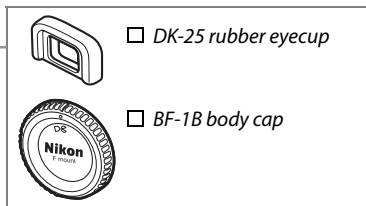
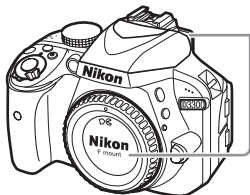

D3300 camera

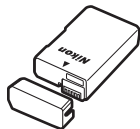

EN-EL14a rechargeable Li-ion battery (with terminal cover)



MH-24 battery charger (plug adapter supplied in countries or regions where required; shape depends on country of sale)

AN-DC3 strap

UC-E17 USB cable

EG-CP14 audio/video cable

ViewNX 2 CD-ROM

User's Manual (this booklet)

Warranty

Purchasers of the lens kit option should confirm that the package also includes a lens. *Memory cards are sold separately* (📖 95). Cameras purchased in Japan display menus and messages in English and Japanese only; other languages are not supported. We apologize for any inconvenience this may cause.

Quick Start Guide

Follow these steps for a quick start with the D3300.

- 1 Attach the camera strap (11).**
Attach the strap as shown. Repeat for the second eyelet.

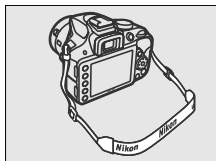

- 2 Charge the battery (11).**

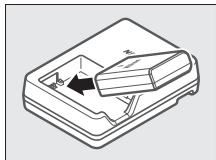

- 3 Insert the battery and memory card (12).**

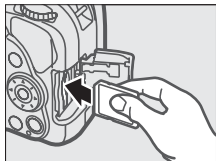
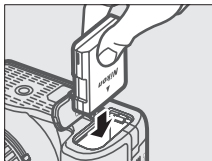

- 4 Attach a lens (13).**

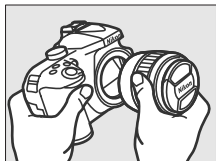

5 Turn the camera on (📖 14).



6 Choose a language and set the camera clock (📖 15).

7 Frame the photograph (📖 24).

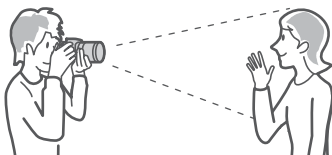

8 Press the shutter-release button halfway (📖 24).

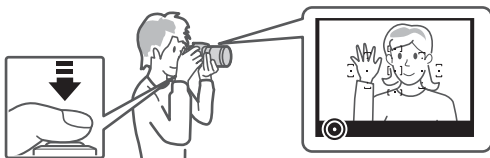

9 Shoot (📖 25).

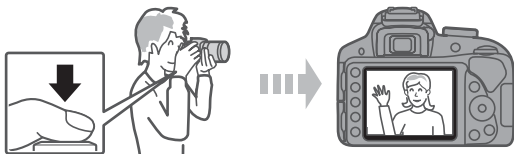

The Reference Manual







For more information on using your Nikon camera, download a pdf copy of the camera *Reference Manual* from the website listed below. The *Reference Manual* can be viewed using Adobe Reader or Adobe Acrobat Reader 5.0 or later.

- 1** On your computer, launch a web browser and open the following site: <http://downloadcenter.nikonimglib.com/>
- 2** Choose a language and download the *Reference Manual*.
- 3** Double-click the downloaded file.













Table of Contents

Package Contents	i
For Your Safety	viii
Notices.....	xii
Introduction	1
<hr/>	
Getting to Know the Camera	1
The Camera Body.....	1
The Mode Dial.....	4
The  (☺/📷) Button.....	6
The Viewfinder.....	7
The Information Display.....	8
First Steps	11
<hr/>	
“Point-and-Shoot” Modes ^{AUTO} (📷) and (📷)	22
<hr/>	
Framing Photos in the Viewfinder	23
Viewing Photographs	26
Deleting Unwanted Pictures	28
Framing Photos in the Monitor	30
Viewing Photographs	34
Deleting Unwanted Pictures	35
Recording Movies	36
Viewing Movies	41
Deleting Unwanted Movies	43
Guide Mode	44
<hr/>	
The Guide.....	44
Guide Mode Menus.....	45
Using the Guide.....	48



Matching Settings to the Subject or Situation (Scene Mode) 50

 Portrait.....	50
 Landscape	50
 Child	50
 Sports	51
 Close up	51
 Night Portrait	51

Special Effects 52

 Night Vision	53
VI Super Vivid	53
POP Pop.....	53
 Photo Illustration	53
 Color Sketch.....	53
 Toy Camera Effect.....	54
 Miniature Effect.....	54
 Selective Color	54
 Silhouette	54
 High Key.....	54
 Low Key.....	55
 HDR Painting	55
 Easy Panorama.....	55
Options Available in Live View	57
 Easy Panorama	64

P, S, A, and M Modes 68

Mode P (Programmed Auto).....	69
Mode S (Shutter-Priority Auto).....	69
Mode A (Aperture-Priority Auto)	70
Mode M (Manual).....	71
Exposure Compensation (P, S, A, M ,  and  modes only)	73

Camera Menus	75
<hr/>	
Menu Options	76
Using Camera Menus	79
ViewNX 2	82
<hr/>	
Installing ViewNX 2.....	82
Using ViewNX 2	85
Copy Pictures to the Computer	85
View Pictures	87
Technical Notes	89
<hr/>	
Compatible Lenses.....	89
Other Accessories.....	91
Approved Memory Cards.....	95
Caring for the Camera	96
Storage	96
Cleaning	96
Caring for the Camera and Battery: Cautions.....	97
Caring for the Camera.....	97
Caring for the Battery	100
Error Messages.....	102
Specifications.....	106
Battery Life	121
Warranty Terms - Nikon Europe Service Warranty	123

For Your Safety

To prevent damage to your Nikon product or injury to yourself or to others, read the following safety precautions in their entirety before using this equipment. Keep these safety instructions where all those who use the product will read them.

The consequences that could result from failure to observe the precautions listed in this section are indicated by the following symbol:



This icon marks warnings. To prevent possible injury, read all warnings before using this Nikon product.

■ ■ WARNINGS

Keep the sun out of the frame

Keep the sun well out of the frame when shooting backlit subjects. Sunlight focused into the camera when the sun is in or close to the frame could cause a fire.

Do not look at the sun through the viewfinder

Viewing the sun or other strong light source through the viewfinder could cause permanent visual impairment.

Using the viewfinder diopter adjustment control

When operating the viewfinder diopter adjustment control with your eye to the viewfinder, care should be taken not to put your finger in your eye accidentally.

Turn off immediately in the event of malfunction

Should you notice smoke or an unusual smell coming from the equipment or AC adapter (available separately), unplug the AC adapter and remove the battery immediately, taking care to avoid burns. Continued operation could result in injury. After removing the battery, take the equipment to a Nikon-authorized service center for inspection.

Do not use in the presence of flammable gas

Do not use electronic equipment in the presence of flammable gas, as this could result in explosion or fire.

Keep out of reach of children

Failure to observe this precaution could result in injury. In addition, note that small parts constitute a choking hazard. Should a child swallow any part of this equipment, consult a physician immediately.

⚠ Do not disassemble

Touching the product's internal parts could result in injury. In the event of malfunction, the product should be repaired only by a qualified technician. Should the product break open as the result of a fall or other accident, remove the battery and/or AC adapter and then take the product to a Nikon-authorized service center for inspection.

⚠ Do not place the strap around the neck of an infant or child

Placing the camera strap around the neck of an infant or child could result in strangulation.

⚠ Do not remain in contact with the camera, battery, or charger for extended periods while the devices are on or in use

Parts of the device become hot. Leaving the device in direct contact with the skin for extended periods may result in low-temperature burns.

⚠ Do not leave the product where it will be exposed to extremely high temperatures, such as in an enclosed automobile or in direct sunlight

Failure to observe this precaution could cause damage or fire.

⚠ Do not aim a flash at the operator of a motor vehicle

Failure to observe this precaution could result in accidents.

⚠ Observe caution when using the flash

- Using the camera with the flash in close contact with the skin or other objects could cause burns.
- Using the flash close to the subject's eyes could cause temporary visual impairment. The flash should be no less than one meter (3 ft 4 in.) from the subject. Particular care should be observed when photographing infants.

⚠ Avoid contact with liquid crystal

Should the monitor break, care should be taken to avoid injury due to broken glass and to prevent the liquid crystal from the monitor touching the skin or entering the eyes or mouth.

⚠ Do not carry tripods with a lens or camera attached

You could trip or accidentally strike others, resulting in injury.

⚠ Observe proper precautions when handling batteries

Batteries may leak, overheat, rupture, or catch fire if improperly handled. Observe the following precautions when handling batteries for use in this product:

- Use only batteries approved for use in this equipment.
- Do not short or disassemble the battery.
- Do not expose the battery or the camera in which it is inserted to powerful physical shocks.
- Be sure the product is off before replacing the battery. If you are using an AC adapter, be sure it is unplugged.
- Do not attempt to insert the battery upside down or backwards.
- Do not expose the battery to flame or to excessive heat.
- Do not immerse in or expose to water.
- Replace the terminal cover when transporting the battery. Do not transport or store the battery with metal objects such as necklaces or hairpins.
- Batteries are prone to leakage when fully discharged. To avoid damage to the product, be sure to remove the battery when no charge remains.
- When the battery is not in use, attach the terminal cover and store in a cool, dry place.

- The battery may be hot immediately after use or when the product has been used on battery power for an extended period. Before removing the battery turn the camera off and allow the battery to cool.
- Discontinue use immediately should you notice any changes in the battery, such as discoloration or deformation.

⚠ Observe proper precautions when handling the charger

- Keep dry. Failure to observe this precaution could result in injury or product malfunction due to fire or electric shock.
- Do not short the charger terminals. Failure to observe this precaution could result in overheating and damage to the charger.
- Dust on or near the metal parts of the plug should be removed with a dry cloth. Continued use could result in fire.
- Do not go near the charger during thunderstorms. Failure to observe this precaution could result in electric shock.
- Do not handle the plug or charger with wet hands. Failure to observe this precaution could result in injury or product malfunction due to fire or electric shock.
- Do not use with travel converters or adapters designed to convert from one voltage to another or with DC-to-AC inverters. Failure to observe this precaution could damage the product or cause overheating or fire.

⚠ Use appropriate cables

When connecting cables to the input and output jacks, use only the cables provided or sold by Nikon for the purpose to maintain compliance with product regulations.

⚠ CD-ROMs

CD-ROMs containing software or manuals should not be played back on audio CD equipment. Playing CD-ROMs on an audio CD player could cause hearing loss or damage the equipment.

⚠ Follow the directions of airline and hospital personnel

This camera transmits radio frequencies that could interfere with medical equipment or aircraft navigation. Disable the wireless network feature and remove all wireless accessories from the camera before boarding an aircraft, and turn the camera off during take off and landing. In medical facilities, follow staff instructions regarding the use of wireless devices.

Notices

- No part of the manuals included with this product may be reproduced, transmitted, transcribed, stored in a retrieval system, or translated into any language in any form, by any means, without Nikon's prior written permission.
- Nikon reserves the right to change the appearance and specifications of the hardware and software described in these manuals at any time and without prior notice.
- Nikon will not be held liable for any damages resulting from the use of this product.
- While every effort has been made to ensure that the information in these manuals is accurate and complete, we would appreciate it were you to bring any errors or omissions to the attention of the Nikon representative in your area (address provided separately).

Notice for Customers in Canada

CAN ICES-3 B / NMB-3 B

Notices for Customers in Europe

CAUTION: RISK OF EXPLOSION IF BATTERY IS REPLACED BY AN INCORRECT TYPE. DISPOSE OF USED BATTERIES ACCORDING TO THE INSTRUCTIONS.

This symbol indicates that electrical and electronic equipment is to be collected separately.



This symbol on the battery indicates that the battery is to be collected separately.



The following apply only to users in European countries:

- This product is designated for separate collection at an appropriate collection point. Do not dispose of as household waste.
- Separate collection and recycling helps conserve natural resources and prevent negative consequences for human health and the environment that might result from incorrect disposal.
- For more information, contact the retailer or the local authorities in charge of waste management.

The following apply only to users in European countries:

- All batteries, whether marked with this symbol or not, are designated for separate collection at an appropriate collection point. Do not dispose of as household waste.
- For more information, contact the retailer or the local authorities in charge of waste management.

Notices for Customers in the U.S.A.

The Battery Charger

IMPORTANT SAFETY INSTRUCTIONS—SAVE THESE INSTRUCTIONS

DANGER—TO REDUCE THE RISK OF FIRE OR ELECTRIC SHOCK, CAREFULLY FOLLOW THESE INSTRUCTIONS

For connection to a supply not in the U.S.A., use an attachment plug adapter of the proper configuration for the power outlet if needed. This power unit is intended to be correctly oriented in a vertical or floor mount position.

Federal Communications Commission (FCC) Radio Frequency Interference Statement

This equipment has been tested and found to comply with the limits for a Class B digital device, pursuant to Part 15 of the FCC rules. These limits are designed to provide reasonable protection against harmful interference in a residential installation. This equipment generates, uses, and can radiate radio frequency energy and, if not installed and used in accordance with the instructions, may cause harmful interference to radio communications. However, there is no guarantee that interference will not occur in a particular installation. If this equipment does cause harmful interference to radio or television reception, which can be determined by turning the equipment off and on, the user is encouraged to try to correct the interference by one or more of the following measures:

- Reorient or relocate the receiving antenna.
- Increase the separation between the equipment and receiver.
- Connect the equipment into an outlet on a circuit different from that to which the receiver is connected.
- Consult the dealer or an experienced radio/television technician for help.



Nikon
D3300

CAUTIONS

Modifications

The FCC requires the user be notified that any changes or modifications made to this device that are not expressly approved by Nikon Corporation may void the user's authority to operate the equipment.

Interface Cables

Use the interface cables sold or provided by Nikon for your equipment. Using other interface cables may exceed the limits of Class B Part 15 of the FCC rules.

Notice for Customers in the State of California

WARNING: Handling the cord on this product may expose you to lead, a chemical known to the State of California to cause birth defects or other reproductive harm. *Wash hands after handling.*

Nikon Inc., 1300 Walt Whitman Road,
Melville, New York 11747-3064, U.S.A.
Tel.: 631-547-4200

Notice Concerning Prohibition of Copying or Reproduction

Note that simply being in possession of material that has been digitally copied or reproduced by means of a scanner, digital camera, or other device may be punishable by law.

• Items prohibited by law from being copied or reproduced

Do not copy or reproduce paper money, coins, securities, government bonds, or local government bonds, even if such copies or reproductions are stamped “Sample.”

The copying or reproduction of paper money, coins, or securities which are circulated in a foreign country is prohibited.

Unless the prior permission of the government has been obtained, the copying or reproduction of unused postage stamps or post cards issued by the government is prohibited.

The copying or reproduction of stamps issued by the government and of certified documents stipulated by law is prohibited.

• Cautions on certain copies and reproductions

The government has issued cautions on copies or reproductions of securities issued by private companies (shares, bills, checks, gift certificates, etc.), commuter passes, or coupon tickets, except when a minimum of necessary copies are to be provided for business use by a company. Also, do not copy or reproduce passports issued by the government, licenses issued by public agencies and private groups, ID cards, and tickets, such as passes and meal coupons.

• Comply with copyright notices

The copying or reproduction of copyrighted creative works such as books, music, paintings, woodcuts, prints, maps, drawings, movies, and photographs is governed by national and international copyright laws. Do not use this product for the purpose of making illegal copies or to infringe copyright laws.

Disposing of Data Storage Devices

Please note that deleting images or formatting memory cards or other data storage devices does not completely erase the original image data. Deleted files can sometimes be recovered from discarded storage devices using commercially available software, potentially resulting in the malicious use of personal image data. Ensuring the privacy of such data is the user's responsibility.

Before discarding a data storage device or transferring ownership to another person, erase all data using commercial deletion software, or format the device and then completely refill it with images containing no private information (for example, pictures of empty sky). Be sure to also replace any pictures selected for preset manual. Care should be taken to avoid injury when physically destroying data storage devices.

AVC Patent Portfolio License

THIS PRODUCT IS LICENSED UNDER THE AVC PATENT PORTFOLIO LICENSE FOR THE PERSONAL AND NON-COMMERCIAL USE OF A CONSUMER TO (i) ENCODE VIDEO IN COMPLIANCE WITH THE AVC STANDARD ("AVC VIDEO") AND/OR (ii) DECODE AVC VIDEO THAT WAS ENCODED BY A CONSUMER ENGAGED IN A PERSONAL AND NON-COMMERCIAL ACTIVITY AND/OR WAS OBTAINED FROM A VIDEO PROVIDER LICENSED TO PROVIDE AVC VIDEO. NO LICENSE IS GRANTED OR SHALL BE IMPLIED FOR ANY OTHER USE. ADDITIONAL INFORMATION MAY BE OBTAINED FROM MPEG LA, L.L.C. SEE <http://www.mpegla.com>

Use Only Nikon Brand Electronic Accessories

Nikon cameras are designed to the highest standards and include complex electronic circuitry. Only Nikon brand electronic accessories (including chargers, batteries, AC adapters, and flash accessories) certified by Nikon specifically for use with this Nikon digital camera are engineered and proven to operate within the operational and safety requirements of this electronic circuitry.

The use of non-Nikon electronic accessories could damage the camera and may void your Nikon warranty. The use of third-party rechargeable Li-ion batteries not bearing the Nikon holographic seal shown at right could interfere with normal operation of the camera or result in the batteries overheating, igniting, rupturing, or leaking.

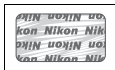

For more information about Nikon brand accessories, contact a local authorized Nikon dealer.

Use Only Nikon Brand Accessories

Only Nikon brand accessories certified by Nikon specifically for use with your Nikon digital camera are engineered and proven to operate within its operational and safety requirements. THE USE OF NON-NIKON ACCESSORIES COULD DAMAGE YOUR CAMERA AND MAY VOID YOUR NIKON WARRANTY.

Before Taking Important Pictures

Before taking pictures on important occasions (such as at weddings or before taking the camera on a trip), take a test shot to ensure that the camera is functioning normally. Nikon will not be held liable for damages or lost profits that may result from product malfunction.

Life-Long Learning

As part of Nikon's "Life-Long Learning" commitment to ongoing product support and education, continually-updated information is available on-line at the following sites:

- **For users in the U.S.A.:** <http://www.nikonusa.com/>
- **For users in Europe and Africa:** <http://www.europe-nikon.com/support/>
- **For users in Asia, Oceania, and the Middle East:** <http://www.nikon-asia.com/>

Visit these sites to keep up-to-date with the latest product information, tips, answers to frequently-asked questions (FAQs), and general advice on digital imaging and photography. Additional information may be available from the Nikon representative in your area. See the following URL for contact information: <http://imaging.nikon.com/>

Introduction

Getting to Know the Camera

Take a few moments to familiarize yourself with camera controls and displays. You may find it helpful to bookmark this section and refer to it as you read through the rest of the manual.

The Camera Body

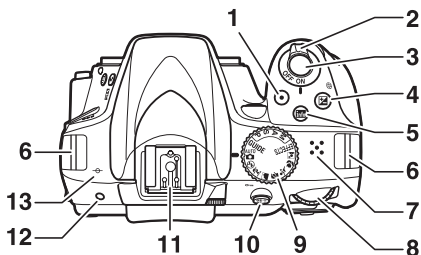

1	Movie-record button	37	8	Command dial	
2	Power switch.....	14	9	Mode dial.....	4
3	Shutter-release button	24, 25	10	AE-L/AF-L button	77
4	AF-ON button.....	71, 73	11	Accessory shoe (for optional flash units)	
5	Info (information) button.....	8	12	Infrared receiver for ML-L3 remote control (rear).....	93
6	Eyelets for camera strap.....	11	13	Focal plane mark (⊖)	
7	Speaker				

The Speaker

Do not place the speaker in close proximity to magnetic devices. Failure to observe this precaution could affect the data recorded on the magnetic devices.

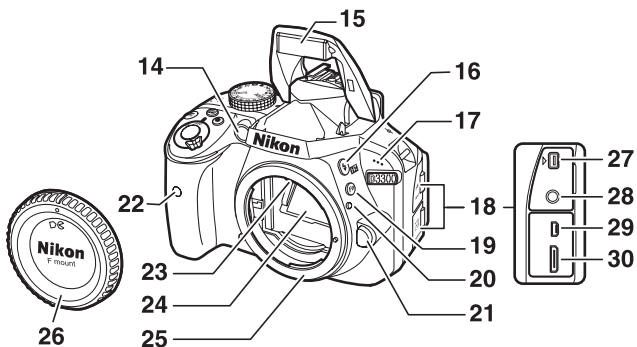

<table border="0"> <tr> <td style="background-color: #444; color: white; padding: 2px;">14</td> <td>AF-assist illuminator Self-timer lamp Red-eye reduction lamp</td> </tr> <tr> <td style="background-color: #444; color: white; padding: 2px;">15</td> <td>Built-in flash.....29</td> </tr> <tr> <td style="background-color: #444; color: white; padding: 2px;">16</td> <td> / button.....68</td> </tr> <tr> <td style="background-color: #444; color: white; padding: 2px;">17</td> <td>Microphone39</td> </tr> <tr> <td style="background-color: #444; color: white; padding: 2px;">18</td> <td>Connector cover</td> </tr> <tr> <td style="background-color: #444; color: white; padding: 2px;">19</td> <td>Fn button77</td> </tr> <tr> <td style="background-color: #444; color: white; padding: 2px;">20</td> <td>Mounting mark13</td> </tr> <tr> <td style="background-color: #444; color: white; padding: 2px;">21</td> <td>Lens release button.....21</td> </tr> <tr> <td style="background-color: #444; color: white; padding: 2px;">22</td> <td>Infrared receiver for ML-L3 remote control (front).....93</td> </tr> </table>	14	AF-assist illuminator Self-timer lamp Red-eye reduction lamp	15	Built-in flash.....29	16	/ button.....68	17	Microphone39	18	Connector cover	19	Fn button77	20	Mounting mark13	21	Lens release button.....21	22	Infrared receiver for ML-L3 remote control (front).....93	<table border="0"> <tr> <td style="background-color: #444; color: white; padding: 2px;">23</td> <td>CPU contacts</td> </tr> <tr> <td style="background-color: #444; color: white; padding: 2px;">24</td> <td>Mirror</td> </tr> <tr> <td style="background-color: #444; color: white; padding: 2px;">25</td> <td>Lens mount.....13</td> </tr> <tr> <td style="background-color: #444; color: white; padding: 2px;">26</td> <td>Body cap</td> </tr> <tr> <td style="background-color: #444; color: white; padding: 2px;">27</td> <td>Accessory terminal.....94</td> </tr> <tr> <td style="background-color: #444; color: white; padding: 2px;">28</td> <td>Connector for external microphone94</td> </tr> <tr> <td style="background-color: #444; color: white; padding: 2px;">29</td> <td>USB and A/V connector85</td> </tr> <tr> <td style="background-color: #444; color: white; padding: 2px;">30</td> <td>HDMI mini-pin connector</td> </tr> </table>	23	CPU contacts	24	Mirror	25	Lens mount.....13	26	Body cap	27	Accessory terminal.....94	28	Connector for external microphone94	29	USB and A/V connector85	30	HDMI mini-pin connector
14	AF-assist illuminator Self-timer lamp Red-eye reduction lamp																																		
15	Built-in flash.....29																																		
16	/ button.....68																																		
17	Microphone39																																		
18	Connector cover																																		
19	Fn button77																																		
20	Mounting mark13																																		
21	Lens release button.....21																																		
22	Infrared receiver for ML-L3 remote control (front).....93																																		
23	CPU contacts																																		
24	Mirror																																		
25	Lens mount.....13																																		
26	Body cap																																		
27	Accessory terminal.....94																																		
28	Connector for external microphone94																																		
29	USB and A/V connector85																																		
30	HDMI mini-pin connector																																		

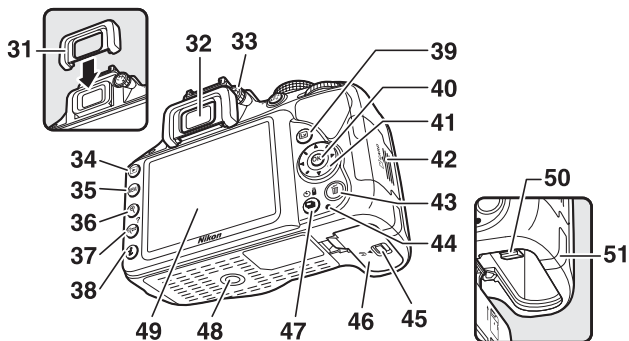

31 Rubber eyecup	43 button 28
32 Viewfinder eyepiece.....7, 17	44 Memory card access lamp..... 25
33 Diopter adjustment control 17	45 Battery-chamber cover latch 12, 19
34 button..... 26	46 Battery-chamber cover 12, 19
35 MENU button..... 75	47 /☺/📶 button.....6
36 button 26	48 Tripod socket
37 /? button26, 79	49 Monitor8, 26, 30
38 button..... 10	50 Battery latch..... 12, 19
39 button.....30, 36	51 Power connector cover for optional power connector
40 (OK) button..... 79	
41 Multi selector 79	
42 Memory card slot cover..... 12, 20	

The Mode Dial

The camera offers a choice of the following shooting modes and **GUIDE** mode:

P, S, A, and M Modes

Select these modes for full control over camera settings.

- **P**—**Programmed auto** (□ 68, 69)
- **S**—**Shutter-priority auto** (□ 68, 69)
- **A**—**Aperture-priority auto** (□ 68, 70)
- **M**—**Manual** (□ 68, 71)

GUIDE Mode (□ 44)

Take, view, and edit pictures and adjust settings with the help of an on-screen guide.

Auto Modes





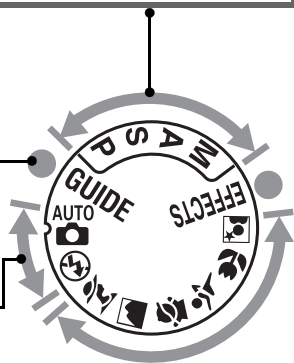







Select these modes for simple, point-and-shoot photography.

-  **Auto** (□ 22)
-  **Auto (flash off)** (□ 22)



Special Effects Modes

Use special effects during shooting.

-  **Night vision** (☞ 53)
-  **VI Super vivid** (☞ 53)
-  **POP Pop** (☞ 53)
-  **Photo illustration** (☞ 53, 57)
-  **Color sketch** (☞ 53, 58)
-  **Toy camera effect** (☞ 54, 59)
-  **Miniature effect** (☞ 54, 60)
-  **Selective color** (☞ 54, 62)
-  **Silhouette** (☞ 54)
-  **High key** (☞ 54)
-  **Low key** (☞ 55)
-  **HDR painting** (☞ 55)
-  **Easy panorama** (☞ 55, 64)

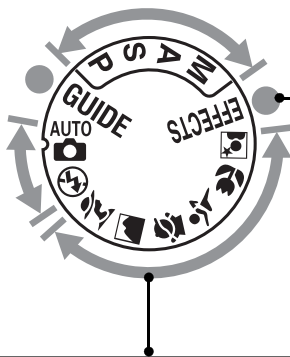





Scene Modes

The camera automatically optimizes settings to suit the scene selected with the mode dial. Match your selection to the scene being photographed.

-  **Portrait** (☞ 50)
-  **Landscape** (☞ 50)
-  **Child** (☞ 50)
-  **Sports** (☞ 51)
-  **Close up** (☞ 51)
-  **Night portrait** (☞ 51)





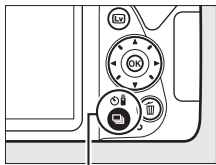

The (/) Button

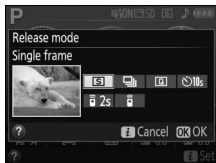
To choose how the shutter is released (release mode), press the  (/) button, then highlight the desired option and press .



 (/) button



Mode	Description
	Single frame: Camera takes one photograph each time shutter-release button is pressed.
	Continuous: The camera takes photographs while the shutter-release button is pressed.
	Quiet shutter release: As for single-frame, except that camera noise is reduced.
	Self-timer: Take pictures using the self-timer. The timer starts when the shutter-release button is pressed all the way down, and the shutter is released after about 10 seconds.
 2s	Delayed remote (ML-L3): Shutter is released 2 s after shutter-release button on optional ML-L3 remote control is pressed.
	Quick-response remote (ML-L3): Shutter is released when shutter-release button on optional ML-L3 remote control is pressed.

The Viewfinder

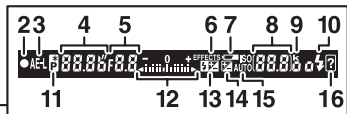
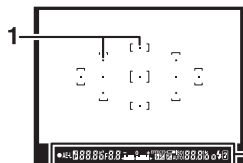
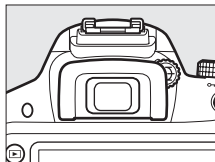

<p>1 Focus points 24</p> <p>2 Focus indicator 24</p> <p>3 Autoexposure (AE) lock indicator</p> <p>4 Shutter speed 72</p> <p>5 Aperture (f-number) 72</p> <p>6 Special effects mode indicator .. 52</p> <p>7 Low battery warning 18</p> <p>8 Number of exposures remaining 16</p> <p>Number of shots remaining before memory buffer fills..... 24</p> <p>White balance recording indicator</p> <p>Exposure compensation value 73</p> <p>Flash compensation value</p> <p>ISO sensitivity 10</p>	<p>9 “k” (appears when memory remains for over 1000 exposures) 16</p> <p>10 Flash-ready indicator 29</p> <p>11 Flexible program indicator</p> <p>12 Exposure indicator 72</p> <p>Exposure compensation display 73</p> <p>Electronic rangefinder</p> <p>13 Flash compensation indicator</p> <p>14 Exposure compensation indicator 73</p> <p>15 Auto ISO sensitivity indicator</p> <p>16 Warning indicator..... 102</p>
---	---

Note: Display shown with all indicators lit for illustrative purposes.

The Information Display

Viewing settings: To view the information display, press the **info** button.

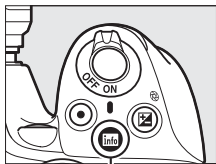

info button



- | | |
|--|---|
| <p>1 Shooting mode
 auto/
 auto (flash off).....22
 Scene modes50
 Special effects mode52
 P, S, A, and M modes.....68</p> | <p>5 Vibration reduction indicator
 20</p> |
| <p>2 Eye-Fi connection indicator</p> | <p>6 Flash control indicator
 Flash compensation indicator for
 optional flash units</p> |
| <p>3 Satellite signal indicator</p> | <p>7 Active D-Lighting76</p> |
| <p>4 Print date indicator77</p> | <p>8 Picture Control76</p> |
| | <p>9 Release mode..... 6</p> |
| | <p>10 “Beep” indicator.....77</p> |

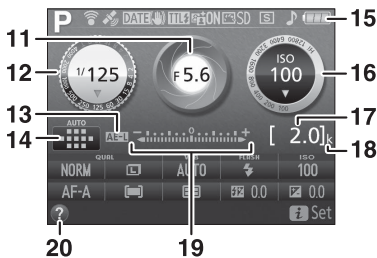

<p>11 Aperture (f-number) 72 Aperture display 72</p> <p>12 Shutter speed 72 Shutter-speed display..... 72</p> <p>13 Autoexposure (AE) lock indicator</p> <p>14 Auto-area AF indicator 3D-tracking indicator Focus point..... 24</p> <p>15 Battery indicator 18</p> <p>16 ISO sensitivity 10 ISO sensitivity display Auto ISO sensitivity indicator</p>	<p>17 Number of exposures remaining 16 White balance recording indicator</p> <p>18 "k" (appears when memory remains for over 1000 exposures) 16</p> <p>19 Exposure indicator 72 Exposure compensation indicator 73</p> <p>20 Help icon..... 102</p>
--	---

Note: Display shown with all indicators lit for illustrative purposes.

☑ Turning the Monitor Off

To clear shooting information from the monitor, press the **info** button or press the shutter-release button halfway. The monitor will turn off automatically if no operations are performed for about 8 seconds (the **Auto off timers** option in the setup menu, can be used to choose how long the monitor remains on).

Changing settings: To change the settings at the bottom of the display, press the **i** button, then highlight items using the multi selector and press **OK** to view options for the highlighted item.

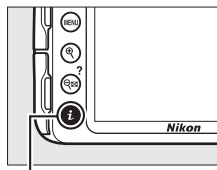

i button

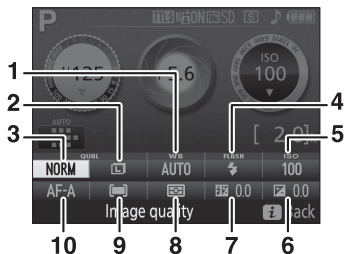

1	White balance	Adjust settings for different types of lighting.
2	Image size	Choose a size for new photos.
3	Image quality	Choose a file format and compression ratio.
4	Flash mode	Choose the flash mode.
5	ISO sensitivity	Control the camera's sensitivity to light.
6	Exposure compensation	Adjust exposure from the value metered by the camera, making the entire frame brighter or darker.
7	Flash compensation	Adjust flash level.
8	Metering	Choose how the camera meters exposure.
9	AF-area mode	Choose how the focus area is selected.
10	Focus mode	Choose how the camera focuses.

First Steps

Always turn the camera off before inserting or removing batteries or memory cards.

1 Attach the strap.

Attach the strap as shown. Repeat for the second eyelet.

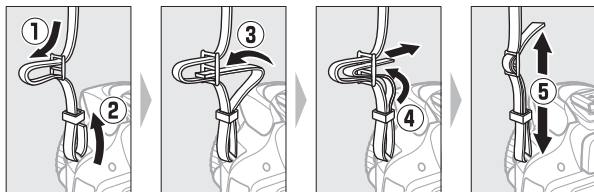

2 Charge the battery.

If a plug adapter is supplied, raise the wall plug and connect the plug adapter as shown below at left, making sure the plug is fully inserted. Insert the battery and plug the charger in. An exhausted battery will fully charge in about an hour and 50 minutes.

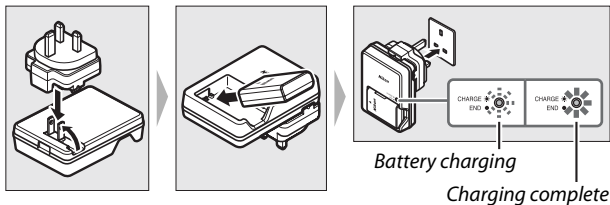

3 Insert the battery and memory card.

Insert the battery in the orientation shown, using the battery to keep the orange battery latch pressed to one side. The latch locks the battery in place when the battery is fully inserted.

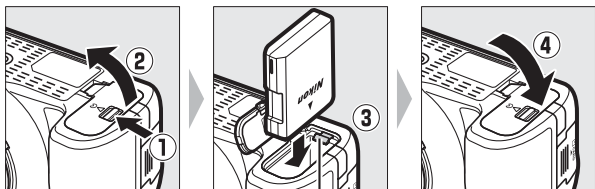

Battery latch

Slide the memory card in until it clicks into place.

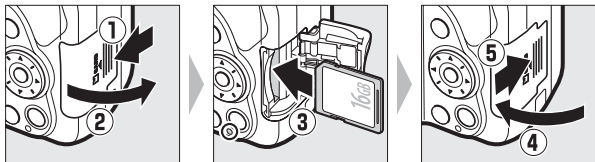

4 Attach a lens.

Be careful to prevent dust from entering the camera when the lens or body cap is removed.

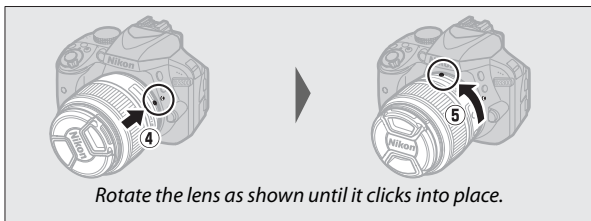
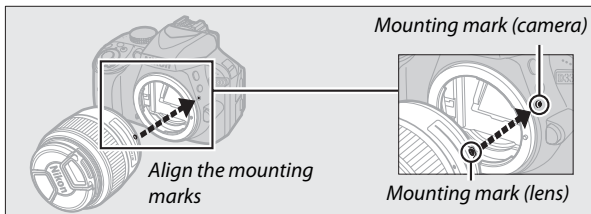
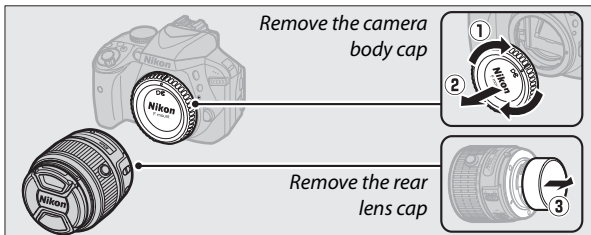

Be sure to remove the lens cap before taking pictures.

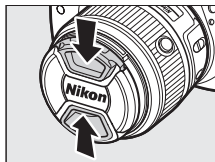

- 5 Turn the camera on.**
A language-selection dialog will be displayed.



The Power Switch

Rotate the power switch as shown to turn the camera on.



Rotate the power switch as shown to turn the camera off.



Lenses with Retractable Lens Barrel Buttons

Before using the camera, unlock and extend the zoom ring. Keeping the retractable lens barrel button pressed (①), rotate the zoom ring as shown (②).

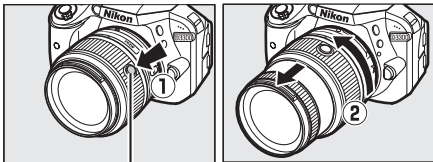

Retractable lens barrel button

Pictures can not be taken when the lens is retracted; if an error message is displayed as a result of the camera having been turned on with the lens retracted, rotate the zoom ring until the message is no longer displayed.



- 6 Choose a language and set the camera clock.**
Use the multi selector and **OK** button to select a language and set the camera clock.

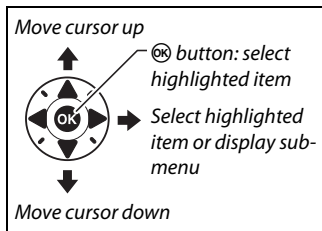

Select language



Select time zone



Select date format

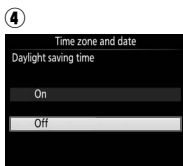

Select daylight saving time option



Set time and date
(note that the camera uses a 24-hour clock)

7 Check the battery level and number of exposures remaining.

Press the **Info** button and check the battery level and number of exposures remaining. In the case of exposures remaining, values over 1000 are shown in thousands, indicated by the letter “k”.

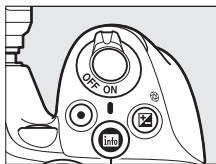

Info button

Battery level (18)



Number of exposures remaining

8 Focus the viewfinder.

After removing the lens cap, rotate the diopter adjustment control until the focus points are in sharp focus. When operating the control with your eye to the viewfinder, be careful not to put your fingers or fingernails in your eye.

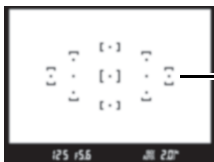
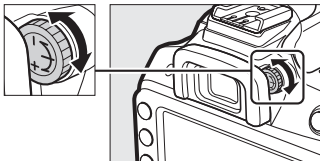

Viewfinder not in focus

Focus points

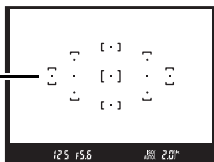

Viewfinder in focus

During Charging

Do not move the charger or touch the battery during charging. Failure to observe this precaution could in very rare instances result in the charger showing that charging is complete when the battery is only partially charged. Remove and reinsert the battery to begin charging again.

✔ Charging the Battery

Read and follow the warnings and cautions on pages viii–xi and 97–101 of this manual. Charge the battery indoors at ambient temperatures of 5 °C–35 °C (41 °F–95 °F). Do not use the battery at ambient temperatures below 0 °C/32 °F or above 40 °C/104 °F; failure to observe this precaution could damage the battery or impair its performance. Capacity may be reduced and charging times may increase at battery temperatures from 0 °C/32 °F to 15 °C/59 °F and from 45 °C/113 °F to 60 °C/140 °F. The battery will not charge if its temperature is below 0 °C (32 °F) or above 60 °C (140 °F). If the **CHARGE** lamp flashes quickly (about eight times a second) during charging, confirm that the temperature is in the correct range and then unplug the charger and remove and reinsert the battery. If the problem persists, cease use immediately and take battery and charger to your retailer or a Nikon-authorized service representative.

Use the charger with compatible batteries only. Unplug when not in use.

✎ Battery Level

Battery level is shown in the information display (if the battery is low, a warning will also be displayed in the viewfinder). If the information display does not appear when the **info** button is pressed, the battery is exhausted and needs to be recharged.



Information display	Viewfinder	Description
	—	Battery fully charged.
	—	Battery partially discharged.
		Low battery. Ready fully-charged spare battery or prepare to charge battery.
 (flashes)	 (flashes)	Battery exhausted. Charge battery.

Removing the Battery

To remove the battery, turn the camera off and open the battery-chamber cover. Press the battery latch in the direction shown by the arrow to release the battery and then remove the battery by hand.

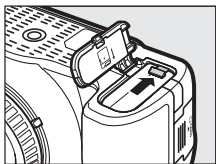

Formatting Memory Cards

If this is the first time the memory card will be used in the camera or if the card has been formatted in another device, select **Format memory card** in the setup menu and follow the on-screen instructions to format the card (77). *Note that this permanently deletes any data the card may contain.* Be sure to copy any photographs and other data you wish to keep to a computer before proceeding.

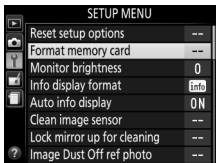

Memory Cards

- Memory cards may be hot after use. Observe due caution when removing memory cards from the camera.
- Turn the power off before inserting or removing memory cards. Do not remove memory cards from the camera, turn the camera off, or remove or disconnect the power source during formatting or while data are being recorded, deleted, or copied to a computer. Failure to observe these precautions could result in loss of data or in damage to the camera or card.
- Do not touch the card terminals with your fingers or metal objects.
- Do not bend, drop, or subject to strong physical shocks.
- Do not apply force to the card casing. Failure to observe this precaution could damage the card.
- Do not expose to water, heat, high levels of humidity, or direct sunlight.
- Do not format memory cards in a computer.

Removing Memory Cards

After confirming that the memory card access lamp is off, turn the camera off, open the memory card slot cover, and press the card in to eject it (1). The card can then be removed by hand (2).

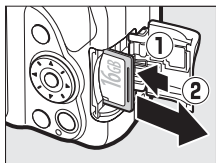

The Write Protect Switch

SD memory cards are equipped with a write protect switch to prevent accidental loss of data.

When this switch is in the "lock" position, the memory card can not be formatted and photos can not be deleted or recorded (a beep will sound if you attempt to release the shutter). To unlock the memory card, slide the switch to the "write" position.

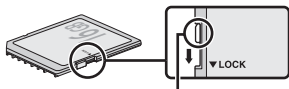

Write-protect switch

A-M, M/A-M, and A/M-M Switches

When using autofocus with a lens equipped with an **A-M** mode switch, slide the switch to **A** (if the lens has an **M/A-M** or **A/M-M** switch, select **M/A** or **A/M**). For information on other lenses that can be used with this camera, see page 89.



Vibration Reduction (VR)

Vibration reduction can be enabled by selecting **On** for **Optical VR** in the shooting menu, if the lens supports this option, or by sliding the lens vibration reduction switch to **ON**, if the lens is equipped with a vibration reduction switch. A vibration reduction indicator appears in the information display when vibration reduction is on.



Detaching the Lens

Be sure the camera is off when removing or exchanging lenses. To remove the lens, press and hold the lens release button (①) while turning the lens clockwise (②). After removing the lens, replace the lens caps and camera body cap.

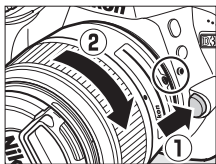

Retracting Lenses with Retractable Lens Barrel Buttons

To retract the lens when the camera is not in use, hold the retractable lens barrel button (①) and rotate the zoom ring to the "L" (lock) position as shown (②). Retract the lens before removing it from the camera, and be careful not to press the retractable lens barrel button when attaching or removing the lens.

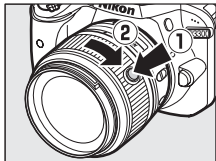



The Camera Clock

The camera clock is less accurate than most watches and household clocks. Check the clock regularly against more accurate time pieces and reset as necessary.



The Clock Battery

The camera clock is powered by an independent, rechargeable power source, which is charged as necessary when the main battery is installed. Three days of charging will power the clock for about a month. If a message warning that the clock is not set is displayed when the camera is turned on, the clock battery is exhausted and the clock has been reset. Set the clock to the correct time and date.

“Point-and-Shoot” Modes (AUTO and)

This section describes how to shoot photographs and movies in  and  modes, automatic “point-and-shoot” modes in which the majority of settings are controlled by the camera in response to shooting conditions.



Before proceeding, turn the camera on and rotate the mode dial to  or  (the only difference between the two is that the flash will not fire in  mode).

Mode dial

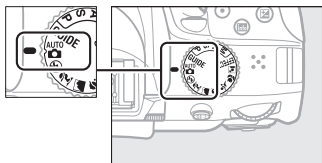

Viewfinder photography



Taking photographs  23

Viewing photographs  26

Deleting photographs  28

Live view



Taking photographs  30

Viewing photographs  34

Deleting photographs  35

Shooting movies  36

Viewing movies  41

Deleting movies  43



Framing Photos in the Viewfinder

1 Ready the camera.

When framing photographs in the viewfinder, hold the handgrip in your right hand and cradle the camera body or lens with your left.



When framing photographs in portrait (tall) orientation, hold the camera as shown at right.



Using a Zoom Lens

Before focusing, rotate the zoom ring to adjust the focal length and frame the photograph. Use the zoom ring to zoom in on the subject so that it fills a larger area of the frame, or zoom out to increase the area visible in the final photograph (select longer focal lengths on the lens focal length scale to zoom in, shorter focal lengths to zoom out). If the lens is equipped with a retractable lens barrel button (14), press and hold the button while rotating the zoom ring until the lens is released and the message shown at right is no longer displayed, and then adjust zoom using the zoom ring.

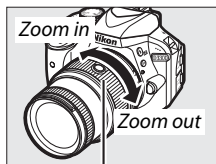

Zoom ring



2 Frame the photograph.

Frame a photograph in the viewfinder with the main subject in at least one of the 11 focus points.

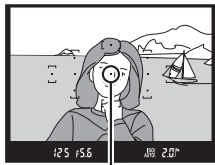

Focus point

3 Press the shutter-release button halfway.

Press the shutter-release button halfway to focus (if the subject is poorly lit, the flash may pop up and the AF-assist illuminator may light). When the focus operation is complete, a beep will sound (a beep may not sound if the subject is moving) and the in-focus indicator (●) will appear in the viewfinder.



In-focus indicator

Buffer capacity

In-focus indicator	Description
●	Subject in focus.
● (flashes)	Camera unable to focus using autofocus. See page 103.

4 Shoot.

Smoothly press the shutter-release button the rest of the way down to take the photograph. The memory card access lamp will light and the photograph will be displayed in the monitor for a few seconds. *Do not eject the memory card or remove or disconnect the power source until the lamp has gone out and recording is complete.*

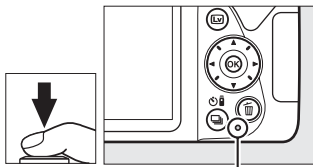

Memory card access lamp



The Shutter-Release Button

The camera has a two-stage shutter-release button. The camera focuses when the shutter-release button is pressed halfway. To take the photograph, press the shutter-release button the rest of the way down.



Focus: press halfway



Shoot: press all the way down



Pressing the shutter-release button halfway also ends playback and readies the camera for immediate use.

Viewing Photographs

Pressing  displays a picture in the monitor.





 button

Press  or  to view additional pictures.



Thumbnail Playback

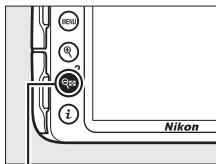

To display images in “contact sheets” of four, nine, or 72 images (thumbnail playback), press the  (?) button. Use the multi selector or command dial to highlight images and press  to display the highlighted image full frame. Press  to reduce the number of images displayed.



 (?) button



■ ■ Calendar Playback

To view images taken on a selected date (calendar playback), press the  (?) button when 72 images are displayed. Press the  (?) button to toggle between the date list and the list of thumbnails for the selected date. Use the multi selector to highlight dates in the date list or to highlight pictures in the thumbnail list. Press  when the cursor is in the date list to return to 72-frame playback.

Date list



Thumbnail list

Deleting Unwanted Pictures

Display the photograph you wish to delete.

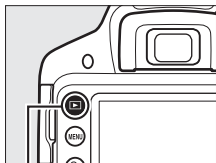

 *button*

Press ; a confirmation dialog will be displayed.

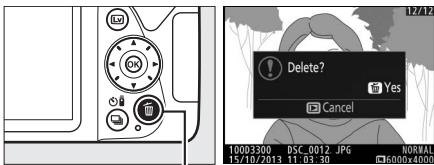

 *button*

Press the  button again to delete the picture.

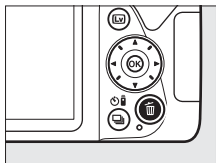

🔍 The Standby Timer

The viewfinder and information display will turn off if no operations are performed for about eight seconds, reducing the drain on the battery. Press the shutter-release button halfway to reactivate the display. The length of time before the standby timer expires automatically can be selected using the **Auto off timers** option in the setup menu (📖 77).





Exposure meters off



Exposure meters on

🔍 The Built-in Flash

If additional lighting is required for correct exposure in  mode, the built-in flash will pop up automatically when the shutter-release button is pressed halfway. If the flash is raised, photographs can only be taken when the flash-ready indicator () is displayed. If the flash-ready indicator is not displayed, the flash is charging; remove your finger briefly from the shutter-release button and try again.

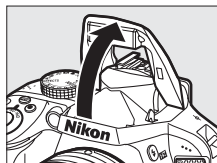

When the flash is not in use, return it to its closed position by pressing it gently downward till the latch clicks into place.



Framing Photos in the Monitor

1 Press the **Lv** button.

The view through the lens will be displayed in the camera monitor (live view).

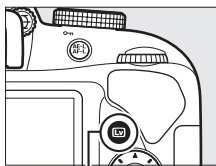

Lv button

2 Ready the camera.

Hold the handgrip in your right hand and cradle the camera body or lens with your left.



When framing photographs in portrait (tall) orientation, hold the camera as shown at right.



3 Focus.

Press the shutter-release button halfway. The focus point will flash green while the camera focuses. If the camera is able to focus, the focus point will be displayed in green; if the camera is unable to focus, the focus point will flash red.



Focus point

4 Take the picture.

Press the shutter-release button the rest of the way down. The monitor turns off and the memory card access lamp lights during recording. *Do not eject the memory card or remove or disconnect the power source until the lamp has gone out and recording is complete.* When recording is complete, the photograph will be displayed in the monitor for a few seconds. Press the  button to exit live view.

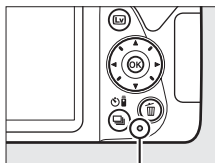

Memory card access lamp

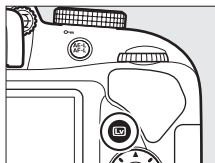

Shooting in Live View Mode

Although it will not appear in the final picture, distortion may be visible in the monitor if the camera is panned horizontally or an object moves at high speed through frame. Bright light sources may leave after-images in the monitor when the camera is panned. Bright spots may also appear. Flicker and banding visible in the monitor under fluorescent, mercury vapor, or sodium lamps can be reduced using **Flicker reduction** (☐ 77), although they may still be visible in the final photograph at some shutter speeds. When shooting in live view mode, avoid pointing the camera at the sun or other strong light sources. Failure to observe this precaution could result in damage to the camera's internal circuitry.

Live view ends automatically if the mode dial is rotated to **GUIDE** or the mode dial is rotated from **GUIDE** to another setting.

Live view may end automatically to prevent damage to the camera's internal circuits; exit live view when the camera is not in use. Note that the temperature of the camera's internal circuits may rise and noise (bright spots, randomly-spaced bright pixels, or fog) may be displayed in the following instances (the camera may also become noticeably warm, but this does not indicate a malfunction):

- The ambient temperature is high
- The camera has been used for extended periods in live view or to record movies
- The camera has been used in continuous release mode for extended periods

If live view does not start when you attempt to start live view, wait for the internal circuits to cool and then try again.

The Count Down Display



A count down will be displayed 30 s before live view ends automatically (the timer turns red 5 s before the auto off timer expires (☐ 77) or if live view is about to end to protect the internal circuits). Depending on shooting conditions, the timer may appear immediately when live view is selected.

Viewing Photographs

Pressing  displays a picture in the monitor.



 *button*

Press  or  to view additional pictures.



Deleting Unwanted Pictures

Display the photograph you wish to delete.

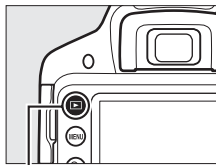

▶ button

Press ; a confirmation dialog will be displayed.

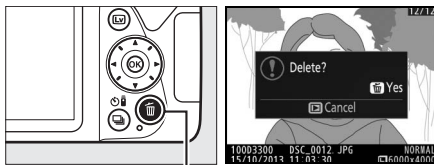

 button

Press the  button again to delete the picture.

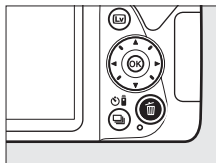

Recording Movies

Movies can be recorded in live view mode.

1 Press the **Lv** button.

The view through the lens is displayed in the monitor.

✓ The icon

A  icon indicates that movies can not be recorded.

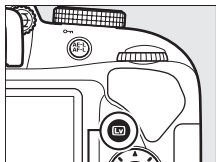

Lv button

2 Ready the camera.

Hold the handgrip in your right hand and cradle the camera body or lens with your left.

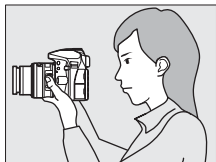

3 Focus.

Press the shutter-release button halfway to focus.



Focus point

4 Start recording.

Press the movie-record button to start recording. A recording indicator and the time available are displayed in the monitor.

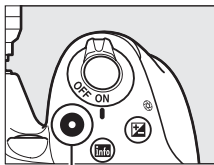

Movie-record button

Recording indicator



Time remaining

5 End recording.

Press the movie-record button again to end recording. Recording will end automatically when the maximum length is reached, the memory card is full, or another mode is selected. Press the **[Lv]** button to exit live view.

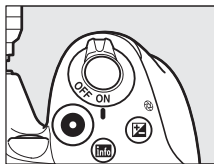

Maximum Length

The maximum size for individual movie files is 4 GB; maximum length varies with the options selected for **Movie settings > Frame size/frame rate** and **Movie quality** in the shooting menu (☐ 76) as shown below. Note that depending on memory card write speed, shooting may end before this length is reached.

	Frame size/frame rate		Maximum length (high movie quality ★/ normal movie quality) ⁴
	Frame size (pixels)	Frame rate ¹	
$\frac{1080 \text{ P}^*}{60} / \frac{1080 \text{ P}}{50}$	1920 × 1080	60p ²	10 min./20 min.
$\frac{1080 \text{ P}^*}{50} / \frac{1080 \text{ P}}{50}$		50p ³	
$\frac{1080 \text{ P}^*}{60} / \frac{1080 \text{ P}}{50}$		30p ²	20 min./29 min. 59 s
$\frac{1080 \text{ P}^*}{25} / \frac{1080 \text{ P}}{25}$		25p ³	
$\frac{1080 \text{ P}^*}{24} / \frac{1080 \text{ P}}{24}$		24p	
$\frac{720 \text{ P}^*}{60} / \frac{720 \text{ P}}{50}$	1280 × 720	60p ²	29 min. 59 s/ 29 min. 59 s
$\frac{720 \text{ P}^*}{50} / \frac{720 \text{ P}}{50}$		50p ³	
$\frac{424 \text{ P}^*}{60} / \frac{424 \text{ P}}{50}$	640 × 424	30p ²	29 min. 59 s/ 29 min. 59 s
$\frac{424 \text{ P}^*}{25} / \frac{424 \text{ P}}{25}$		25p ³	

- 1 Listed value. Actual frame rates for 60p, 50p, 30p, 25p, and 24p are 59.94, 50, 29.97, 25, and 23.976 fps respectively.
- 2 Available when **NTSC** is selected for **Video mode** (☐ 77).
- 3 Available when **PAL** is selected for **Video mode**.
- 4 Movies recorded in miniature effect mode are up to three minutes long when played back.

Recording Movies

Flicker, banding, or distortion may be visible in the monitor and in the final movie under fluorescent, mercury vapor, or sodium lamps or if the camera is panned horizontally or an object moves at high speed through frame (flicker and banding can be reduced using **Flicker reduction**;  77). Bright light sources may leave after-images when the camera is panned. Jagged edges, color fringing, moiré, and bright spots may also appear. Bright bands may appear in some areas of the frame if the subject is briefly illuminated by a flash or other bright, momentary light source. When recording movies, avoid pointing the camera at the sun or other strong light sources. Failure to observe this precaution could result in damage to the camera's internal circuitry.

The camera can record both video and sound; do not cover the microphone during recording. Note that the built-in microphone may record lens noise during autofocus and vibration reduction.

Flash lighting can not be used during movie recording.

Live view may end automatically to prevent damage to the camera's internal circuits; exit live view when the camera is not in use. Note that the temperature of the camera's internal circuits may rise and noise (bright spots, randomly-spaced bright pixels, or fog) may be displayed in the following instances (the camera may also become noticeably warm, but this does not indicate a malfunction):



- The ambient temperature is high
- The camera has been used for extended periods in live view or to record movies
- The camera has been used in continuous release mode for extended periods

If live view does not start when you attempt to start live view or movie recording, wait for the internal circuits to cool and then try again.

✔ The Count-Down Display

A count down will be displayed 30 s before live view ends automatically. Depending on shooting conditions, the timer may appear immediately when movie recording begins. Note that regardless of the amount of recording time available, live view will still end automatically when the timer expires. Wait for the internal circuits to cool before resuming movie recording.

Viewing Movies

Press  to start playback and then scroll through pictures until a movie (indicated by a  icon) is displayed.

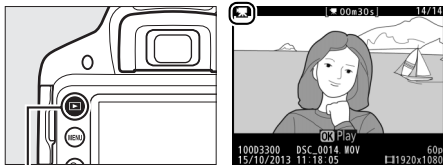





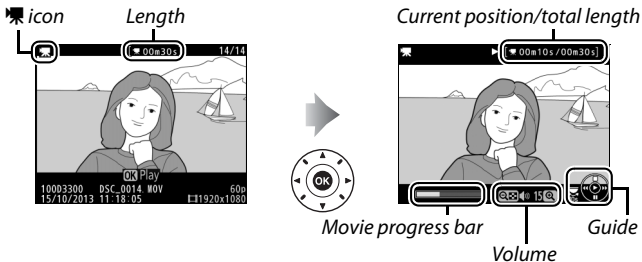







 button

Press  to start playback; your current position is indicated by the movie progress bar.



The following operations can be performed:

To	Use	Description
Pause		Pause playback.
Play		Resume playback when movie is paused or during rewind/advance.
Advance/rewind		Speed increases with each press, from 2x to 4x to 8x to 16x; keep pressed to skip to beginning or end of movie (first frame is indicated by  in top right corner of monitor, last frame by ). If playback is paused, movie rewinds or advances one frame at a time; hold for continuous rewind or advance.
Skip 10 s		Rotate the command dial to skip ahead or back 10 s.
Adjust volume	 (?)	Press  to increase volume,  (?) to decrease.
Return to full-frame playback	 / 	Press  or  to exit to full-frame playback.

Deleting Unwanted Movies

Display the movie you wish to delete (movies are indicated by  icons).

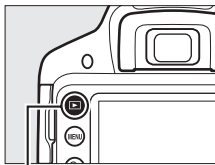

 *button*

Press ; a confirmation dialog will be displayed.

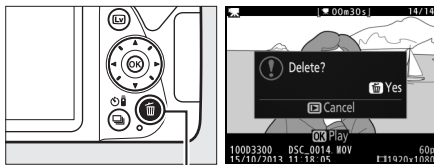

 *button*

Press the  button again to delete the movie.

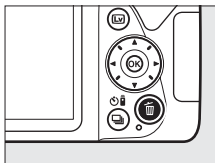

Guide Mode

The Guide

Guide mode gives access to a variety of frequently-used and useful functions. The top level of the guide is displayed when the mode dial is rotated to **GUIDE**.

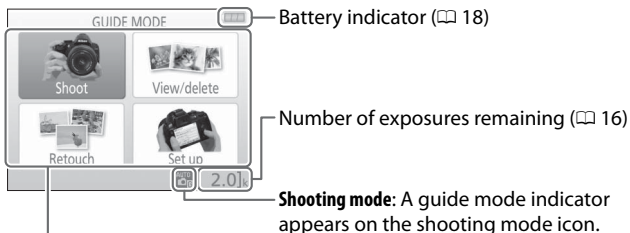

Choose from the following items:

Shoot	View/delete
<p>Take pictures.</p>	<p>View and/or delete pictures.</p>
Retouch	Set up
<p>Retouch pictures.</p>	<p>Change camera settings.</p>

Guide Mode Menus

To access these menus, highlight **Shoot**, **View/delete**, **Retouch**, or **Set up** and press **OK**.

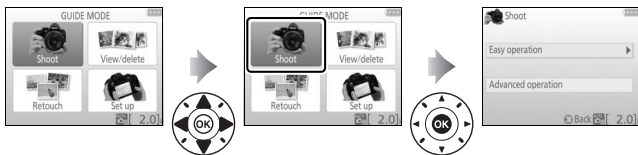

Shoot

Easy operation

	Auto
	No flash
	Distant subjects
	Close-ups
	Sleeping faces
	Moving subjects
	Landscapes
	Portraits
	Night portrait
	Photograph night landscapes

Advanced operation

	Soften backgrounds	Adjust aperture.
	Bring more into focus	
	Freeze motion (people)	Select a shutter speed.
	Freeze motion (vehicles)	
	Show water flowing	
	Capture reds in sunsets*	Adjust white balance to vividly capture the colors in sunsets.
	Take bright photos*	Adjust exposure compensation to take bright (high key) or dark (low key) photos.
	Take dark (low key) photos*	
	Reduce blur	Adjust auto ISO sensitivity control for poorly lit subjects or telephoto lenses.

* Affects other **Advanced operation** items. To restore default settings, turn the camera off and then on again.

“Start Shooting”

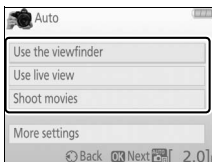

Highlight an option and press **OK**.

- Use the viewfinder
- Use live view
- Shoot movies

“More Settings”

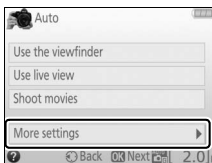

If **More settings** is displayed, you can highlight this option and press **▶** to access the following settings (the settings available vary with the shooting option selected):

- Flash settings > Flash mode
- Flash settings > Flash compensation
- Release mode
- ISO sensitivity settings > ISO sensitivity
- ISO sensitivity settings > Auto ISO sensitivity control
- Set Picture Control
- Exposure compensation
- White balance

■ View/Delete

View single photos

View multiple photos

Choose a date

View a slide show

Delete photos

Guide Mode

Guide mode is reset to **Easy operation > Auto** when the mode dial is rotated to another setting or the camera is turned off.

■ ■ Retouch

Trim

Filter effects (cross screen)

Filter effects (soft)

Photo illustration

Miniature effect

Selective color

■ ■ Set Up

Image quality

Image size

Auto off timers

Print date

Display and sound settings

Monitor brightness

Info background color

Auto info display

Beep

Movie settings

Frame size/frame rate

Movie quality

Microphone

Wind noise reduction

Flicker reduction

Playback folder

Playback display options

DPOF print order

Clock and language

Time zone and date

Language

Format memory card

Output settings

HDMI

Video mode

Wireless mobile adapter

Eye-Fi upload *







Slot empty release lock



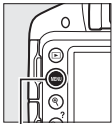

* Only available when compatible Eye-Fi memory card is inserted.

Changes to **Image quality**, **Image size**, **Auto off timers**, **Print date**, **Playback folder**, **Playback display options**, all **Display and sound settings** options, and all **Movie settings** options except **Flicker reduction** apply in guide mode only and are not reflected in other shooting modes.

Using the Guide

The following operations can be performed while the guide is displayed:

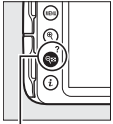
To	Use	Description
Return to top level of guide	 MENU button	Press MENU to turn the monitor on or return to the top level of the guide.
Turn monitor on		
Highlight a menu		Press ▲ , ▼ , ◀ , or ▶ to highlight a menu.
Highlight options		Press ▲ or ▼ to highlight options in the menus.
		Press ▲ , ▼ , ◀ , or ▶ to highlight options in displays like that shown below. <div data-bbox="643 695 919 904" style="border: 1px solid black; padding: 5px; margin-top: 10px;"> <p>Release mode</p> <p>Single frame</p> <p> Take one photo each time you press the shutter button.</p> <p>[S] [M] [A]</p> <p>10s 2s [] []</p> <p>Move OK OK [] [] 2.0</p> </div>
Select highlighted menu or option		Press OK to select the highlighted menu or option.

To	Use	Description
Return to previous display		Press ◀ to return to the previous display.
		To cancel and return to the previous display from displays like that shown below, highlight ↶ and press ○K.
View help	 ? (?) button	<p>If a ? icon is displayed at the bottom left corner of the monitor, help can be displayed by pressing the ? (?) button. A description of the currently selected option will be displayed while the button is pressed. Press ▲ or ▼ to scroll through the display.</p>  ? (help) icon

Matching Settings to the Subject or Situation (Scene Mode)

The camera offers a choice of “scene” modes. Choosing a scene mode automatically optimizes settings to suit the selected scene, making creative photography as simple as selecting a mode, framing a picture, and shooting as described on page 22.

The following scenes can be selected with the mode dial:

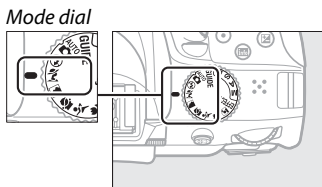

Portrait

Use for portraits with soft, natural-looking skin tones. If the subject is far from the background or a telephoto lens is used, background details will be softened to lend the composition a sense of depth.

Landscape

Use for vivid landscape shots in daylight.

Note: The built-in flash and AF-assist illuminator turn off.

Child

Use for snapshots of children. Clothing and background details are vividly rendered, while skin tones remain soft and natural.

Sports

Fast shutter speeds freeze motion for dynamic sports shots in which the main subject stands out clearly.

Note: The built-in flash and AF-assist illuminator turn off.

Close up

Use for close-up shots of flowers, insects, and other small objects (a macro lens can be used to focus at very close ranges).

Night Portrait













Use for a natural balance between the main subject and the background in portraits taken under low light.

Preventing Blur

Use a tripod to prevent blur caused by camera shake at slow shutter speeds.

Special Effects

Special effects can be used when recording images.

 Night Vision	 Selective Color
 VI Super Vivid	 Silhouette
 POP Pop	 High Key
 Photo Illustration	 Low Key
 Color Sketch	 HDR Painting
 Toy Camera Effect	 Easy Panorama
 Miniature Effect	



The following effects can be selected by rotating the mode dial to **EFFECTS** and rotating the command dial until the desired option appears in the monitor.

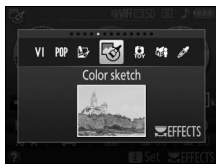
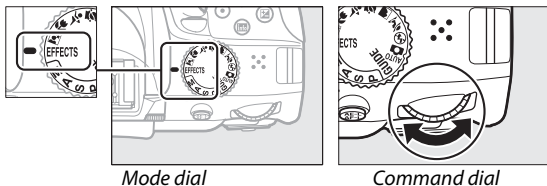

Night Vision

Use under conditions of darkness to record monochrome images at high ISO sensitivities.

Note: Pictures may be affected by noise in the form of randomly-spaced bright pixels, fog, or lines. Autofocus is available in live view only; manual focus can be used if the camera is unable to focus. The built-in flash and AF-assist illuminator turn off.

Super Vivid



Overall saturation and contrast are increased for a more vibrant image.

POP Pop

Overall saturation is increased for a more lively image.

Photo Illustration

Sharpen outlines and simplify coloring for a poster effect that can be adjusted in live view (□ 57).

Note: The flash turns off automatically; to use the flash, choose a flash mode (□ 10) of  **AUTO** (auto) or  **AUTO** (auto + red-eye reduction). Movies shot in this mode play back like a slide show made up of a series of stills.

Color Sketch

The camera detects and colors outlines for a color sketch effect. The effect can be adjusted in live view (□ 58).

Note: Movies shot in this mode play back like a slide show made up of a series of stills.

Toy Camera Effect

Create photos and movies that appear to have been shot with a toy camera. The effect can be adjusted in live view (📖 59).

Miniature Effect

Create photos that appear to be pictures of dioramas. Works best when shooting from a high vantage point. Miniature effect movies play back at high speed, compressing about 45 minutes of footage shot at 1920 × 1080/30p into a movie that plays back in about three minutes. The effect can be adjusted in live view (📖 60).

Note: Sound is not recorded with movies. The built-in flash and AF-assist illuminator turn off.

Selective Color

All colors other than the selected colors are recorded in black and white. The effect can be adjusted in live view (📖 62).

Note: The built-in flash turns off.

Silhouette

Silhouette subjects against bright backgrounds.

Note: The built-in flash turns off.

High Key

Use with bright scenes to create bright images that seem filled with light.

Note: The built-in flash turns off.

Low Key

Use with dark scenes to create dark, low-key images with prominent highlights.

Note: The built-in flash turns off.

HDR Painting

Each time a photo is taken, the camera shoots two frames at different exposures and combines them for a painterly effect that emphasizes detail and color.

Note: The effect can not be previewed in live view. Note that the desired results may not be achieved if the camera or subject moves during shooting. During recording, a message is displayed and no further photos can be taken. The built-in flash turns off, continuous shooting is disabled, and movies are recorded in  mode.

Easy Panorama









Shoot panoramas as described on page 64. Start live view before beginning recording; panoramas can not be shot during viewfinder photography.

Note: The built-in flash turns off and movies can not be recorded.

Preventing Blur

Use a tripod to prevent blur caused by camera shake at slow shutter speeds.

NEF (RAW)

NEF (RAW) recording is not available in , VI, POP, , , , , , , , and  modes. Pictures taken when an NEF (RAW) or NEF (RAW) + JPEG fine option is selected in these modes will be recorded as JPEG images. JPEG images created at these settings will be recorded as fine-quality images.

, , and Modes

Autofocus is not available during movie recording. The live view refresh rate will drop, together with the frame rate for continuous release mode; using autofocus during live view photography will disrupt the preview.

Options Available in Live View

Photo Illustration

1 Select live view.

Press the **Lv** button. The view through the lens will be displayed in the monitor.

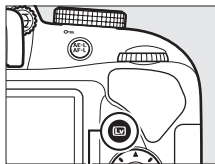

Lv button

2 Adjust outline thickness.

Press **OK** to display the options shown at right. Press **▶** or **◀** to make outlines thicker or thinner.

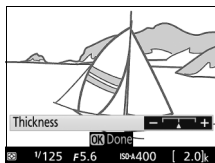

3 Press **OK**.

Press **OK** to exit when settings are complete. To exit live view, press the **Lv** button. The selected settings will continue in effect and will apply to photographs taken using the viewfinder.

1 Select live view.

Press the **Lv** button. The view through the lens will be displayed in the monitor.

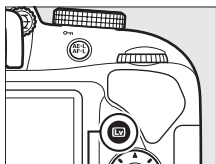

Lv button

2 Adjust options.

Press **OK** to display the options shown at right. Press **▲** or **▼** to highlight **Vividness** or **Outlines** and press **◀** or **▶** to change. Vividness can be increased to make colors more saturated, or decreased for a washed-out, monochromatic effect, while outlines can be made thicker or thinner. Increasing the thickness of the lines also makes colors more saturated.

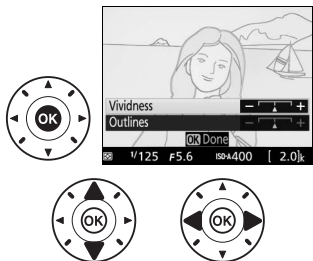

3 Press **OK**.

Press **OK** to exit when settings are complete. To exit live view, press the **Lv** button. The selected settings will continue in effect and will apply to photographs taken using the viewfinder.

1 Select live view.

Press the **Lv** button. The view through the lens will be displayed in the monitor.

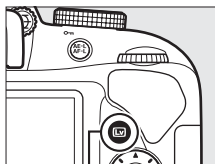

Lv button

2 Adjust options.

Press **OK** to display the options shown at right. Press **▲** or **▼** to highlight **Vividness** or **Vignetting** and press **◀** or **▶** to change. Adjust vividness to make colors more or less saturated, vignetting to control the amount of vignetting.

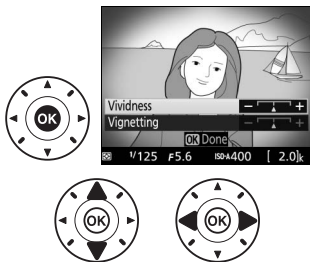

3 Press **OK.**

Press **OK** to exit when settings are complete. To exit live view, press the **Lv** button. The selected settings will continue in effect and will apply to photographs taken using the viewfinder.

1 Select live view.

Press the **Lv** button. The view through the lens will be displayed in the monitor.

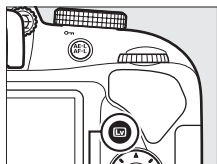
**Lv** button**2 Position the focus point.**

Use the multi selector to position the focus point in the area that will be in focus and then press the shutter-release button halfway to focus. To temporarily clear miniature effect options from the display and enlarge the view in the monitor for precise focus, press **Q**. Press **Q** (?) to restore the miniature effect display.

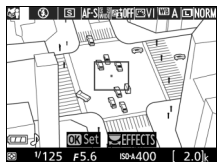
**3 Display options.**

Press **Q** to display miniature effect options.

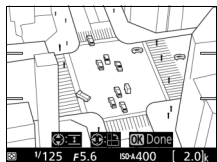

4 Adjust options.

Press ◀ or ▶ to choose the orientation of the area that will be in focus and press ▲ or ▼ to adjust its width.

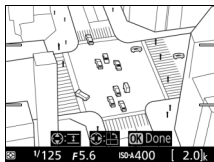

5 Press **OK**.

Press **OK** to exit when settings are complete. To exit live view, press the **Lv** button. The selected settings will continue in effect and will apply to photographs taken using the viewfinder.

1 **Select live view.**

Press the **Lv** button. The view through the lens will be displayed in the monitor.

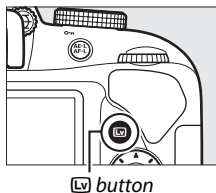
**2** **Display options.**

Press **OK** to display selective color options.

**3** **Select a color.**

Frame an object in the white square in the center of the display and press **▲** to choose the color of the object as one that will remain in the final image (the camera may have difficulty detecting unsaturated colors; choose a saturated color). To zoom in on the center of the display for more precise color selection, press **Q**. Press **Q** (?) to zoom out.

*Selected color*

4 Choose the color range.

Press ▲ or ▼ to increase or decrease the range of similar hues that will be included in the final image. Choose from values between 1 and 7; note that higher values may include hues from other colors.



Color range



5 Select additional colors.

To select additional colors, rotate the command dial to highlight another of the three color boxes at the top of the display and repeat Steps 3 and 4 to select



another color. Repeat for a third color if desired. To deselect the highlighted color, press (To remove all colors, press and hold . A confirmation dialog will be displayed; select **Yes**).

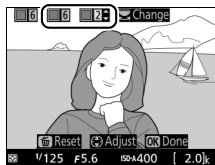

6 Press .

Press to exit when settings are complete. During shooting, only objects of the selected hues will be recorded in color; all others will be recorded in black-and-white. To exit live view, press the button. The selected settings will continue in effect and will apply to photographs taken using the viewfinder.

Easy Panorama

Follow the steps below to shoot panoramas.

1 Select live view.

Press the **Lv** button. A framing grid and the view through the lens will be displayed in the monitor.

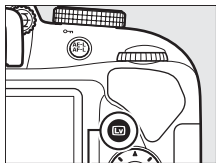

Lv button

2 Focus.

Frame the start of the panorama and press the shutter-release button halfway.

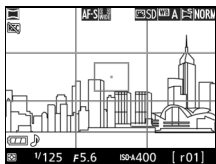

3 Start shooting.

Press the shutter-release button the rest of the way down and then lift your finger from the button. The display will briefly go dark and then turn on with \triangle , ∇ , \triangleleft , and \triangleright icons indicating the possible pan directions; focus and exposure will lock.

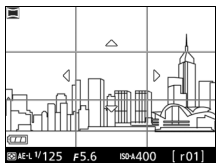

4 Pan the camera.

Slowly pan the camera up, down, left, or right as shown below. Shooting will start when the camera detects the pan direction and a progress indicator will appear in the display. Shooting ends automatically when the end of the panorama is reached.

Progress indicator

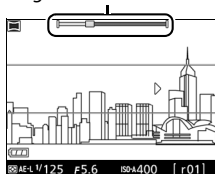

An example of how to pan the camera is shown below. Without changing your position, pan the camera in a steady curve either horizontally or vertically. Time the pan according to the option selected for **Image size** in the shooting menu: about 15 seconds are needed to complete the pan when **Normal panorama** is selected, about 30 seconds when **Wide panorama** is selected.

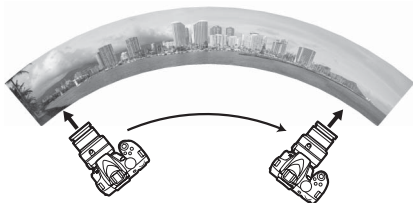

Panoramas

Panorama size can be selected using the **Image size** item in the shooting menu; choose from **Normal panorama** and **Wide panorama** (☐ 76). An error message will be displayed if the camera is panned too quickly or unsteadily. Note that because panoramas are composed of multiple images, the joins between images may be visible and the desired results may not be achieved with moving subjects or with neon lights or other subjects that exhibit rapid changes in color or brightness, subjects that are too close to the camera, poorly-lit subjects, and subjects such as the sky or sea that are a solid color or contain simple repeating patterns.

Exposure compensation (☐ 73) can be used to adjust exposure by up to ± 3 EV in steps of $\frac{1}{3}$ EV. Adjust exposure compensation after starting live view in Step 1.

The completed panorama will be slightly smaller than the area visible in the display during shooting. No panorama will be recorded if shooting ends before the halfway point; if shooting ends after the halfway point but before the panorama is complete, the unrecorded portion will be shown in gray. Dates can not be imprinted on panoramas.

■ ■ Viewing Panoramas

To view a panorama, display it in full-frame playback (📖 26) and press **OK**. The start of the panorama will be displayed with the smallest dimension filling the display and the camera will then scroll through the picture in the original pan direction. Your current position is indicated by the navigation window.

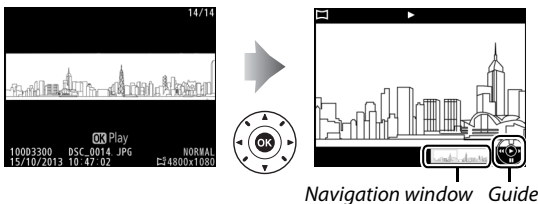

Navigation window Guide

The following operations can be performed:

To	Use	Description
Pause		Pause playback.
Play	OK	Resume playback when the panorama is paused or during rewind/advance.
Advance/rewind		Press ◀ to rewind, ▶ to advance. If playback is paused, the panorama rewinds or advances a segment at a time; keep the button pressed for continuous rewind or advance.
Return to full-frame playback	/	Press ▲ or ▶ to exit to full-frame playback.

P, S, A, and M Modes

P, S, A, and M modes offer different degrees of control over shutter speed and aperture:



Mode		Description
P	Programmed auto (☞ 69)	Recommended for snapshots and in other situations in which there is little time to adjust camera settings. Camera sets shutter speed and aperture for optimal exposure.
S	Shutter-priority auto (☞ 69)	Use to freeze or blur motion. User chooses shutter speed; camera selects aperture for best results.
A	Aperture-priority auto (☞ 70)	Use to blur background or bring both foreground and background into focus. User chooses aperture; camera selects shutter speed for best results.
M	Manual (☞ 71)	User controls both shutter speed and aperture. Set shutter speed to "Bulb" or "Time" for long time-exposures.

Using the Built-in Flash

For flash photography, press the  (☞ 2) button to raise the flash.

Mode A (Aperture-Priority Auto)

In aperture-priority auto, you choose the aperture while the camera automatically selects the shutter speed that will produce the optimal exposure. Rotate the command dial left for larger apertures (lower f-numbers), right for smaller apertures (higher f-numbers).

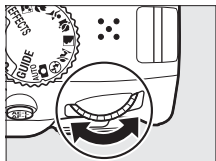

Command dial



Mode M (Manual)

In manual mode, you control both shutter speed and aperture. Checking the exposure indicator (72), adjust shutter speed and aperture. Shutter speed is selected by rotating the command dial (right for faster speeds, left for slower). To adjust aperture, keep the  button pressed while rotating the command dial (left for larger apertures/lower f-numbers and right for smaller apertures/higher f-numbers).

Shutter speed



Command dial



Aperture

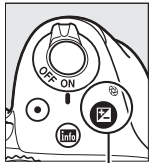

 button



Command dial



Shutter Speed and Aperture

Shutter speed and aperture are shown in the viewfinder and information display.

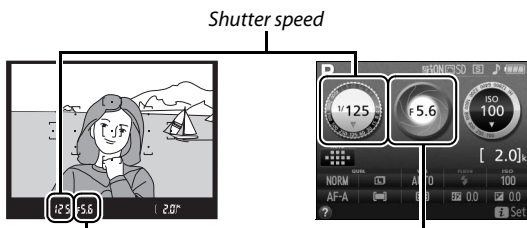

Aperture



Fast shutter speeds ($1/1600$ s in this example) freeze motion.

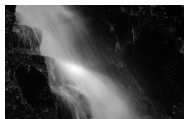

Slow shutter speeds (here 1 s) blur motion.





Large apertures (such as $f/5.6$; remember, the lower the f -number, the larger the aperture) blur details in front of and behind the main subject.



Small apertures ($f/22$ in this case) bring both background and foreground into focus.

The Exposure Indicator

Optimal exposure	Underexposed by $1/3$ EV	Overexposed by over 2 EV
		

Exposure Compensation (P, S, A, M, and modes only)

Exposure compensation is used to alter exposure from the value suggested by the camera, making pictures brighter or darker ( 109).



-1 EV



*No exposure
compensation*



+1 EV



To choose a value for exposure compensation, keep the  button pressed and rotate the command dial until the desired value is selected in the viewfinder or information display. Normal exposure can be restored by setting exposure compensation to ± 0 . Exposure compensation is not reset when the camera is turned off.

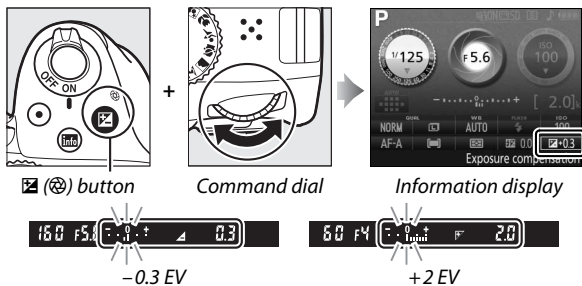

The Information Display

Exposure compensation options can also be accessed from the information display ( 10).

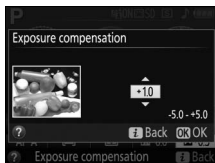

Camera Menus

Most shooting, playback, and setup options can be accessed from the camera menu. To view the menus, press the MENU button.

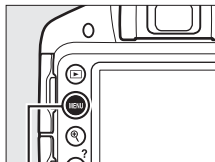

MENU button

Tabs

Choose from the following menus:

- : Playback (📖 76)
- : Shooting (📖 76)
- : Setup (📖 77)
- : Retouch (📖 78)
- : Recent settings (📖 78)

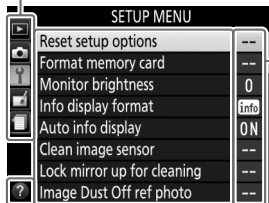

Current settings are shown by icons.

Menu options

Options in current menu.

Help icon (📖 79)

Menu Options

▶ Playback Menu: Managing Images

Delete

Playback folder

Playback display options

Image review

Rotate tall

Slide show

DPOF print order

Rating

Select to send to smart device

📷 Shooting Menu: Shooting Options

Reset shooting menu

Image quality

Image size

White balance

Set Picture Control

Auto distortion control

Color space

Active D-Lighting

Noise reduction

ISO sensitivity settings

AF-area mode

Built-in AF-assist illuminator

Metering

Flash cntrl for built-in flash

Optical VR*

Movie settings

* Available only with lenses that support this item.

Setup Menu: Camera Setup

Reset setup options	Remote on duration (ML-L3)
Format memory card	Beep
Monitor brightness	Rangefinder
Info display format	File number sequence
Auto info display	Buttons
Clean image sensor	Slot empty release lock
Lock mirror up for cleaning	Print date
Image Dust Off ref photo	Storage folder
Flicker reduction	Accessory terminal
Time zone and date	Video mode
Language	HDMI
Auto image rotation	Wireless mobile adapter
Image comment	Eye-Fi upload *
Auto off timers	Firmware version
Self-timer	

* Only available when compatible Eye-Fi memory card is inserted.

Retouch Menu: Creating Retouched Copies

D-Lighting	Distortion control
Red-eye correction	Fisheye
Trim	Color outline
Monochrome	Photo illustration
Filter effects	Color sketch
Color balance	Perspective control
Image overlay	Miniature effect
NEF (RAW) processing	Selective color
Resize	Edit movie
Quick retouch	Side-by-side comparison *
Straighten	

* Available only if retouch menu is displayed by pressing **z** and selecting **Retouch** in full-frame playback when a retouched image or original is displayed.

Recent Settings

The recent settings menu lists the twenty most recently used settings.

Using Camera Menus

The multi selector and  button are used to navigate the camera menus.

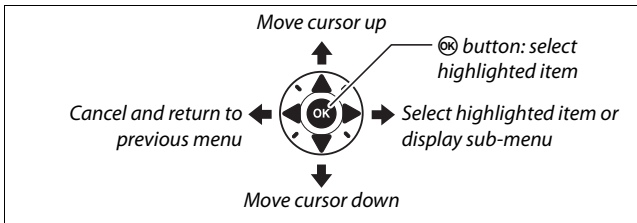

Follow the steps below to navigate the menus.



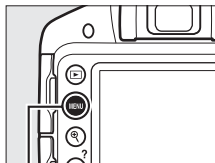

1 Display the menus.

Press the **MENU** button to display the menus.



MENU button

The (Help) Icon

If a  icon is displayed at the bottom left corner of the monitor, help can be displayed by pressing the  (?) button. A description of the currently selected option or menu will be displayed while the button is pressed. Press  or  to scroll through the display.

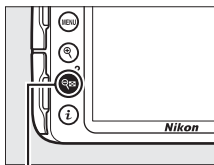

 (?) button

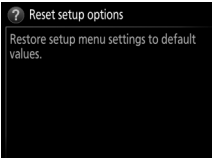

2 Highlight the icon for the current menu.

Press ◀ to highlight the icon for the current menu.



3 Select a menu.

Press ▲ or ▼ to select the desired menu.

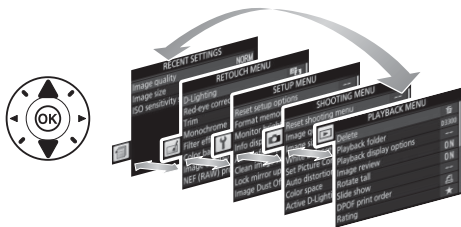

4 Position the cursor in the selected menu.

Press ▶ to position the cursor in the selected menu.

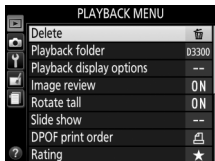

5 Highlight a menu item.

Press ▲ or ▼ to highlight a menu item.

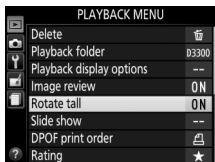

6 Display options.

Press **▶** to display options for the selected menu item.

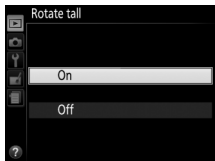

7 Highlight an option.

Press **▲** or **▼** to highlight an option.

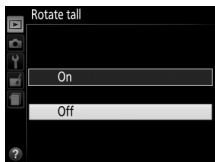

8 Select the highlighted item.

Press **OK** to select the highlighted item. To exit without making a selection, press the **MENU** button.



Note the following:

- Menu items that are displayed in gray are not currently available.
- While pressing **▶** generally has the same effect as pressing **OK**, there are some cases in which selection can only be made by pressing **OK**.
- To exit the menus and return to shooting mode, press the shutter-release button halfway (📖 25).

ViewNX 2

Installing ViewNX 2

Install the supplied software to display and edit photographs and movies that have been copied to your computer. Before installing ViewNX 2, confirm that your computer meets the system requirements on page 84. Be sure to use the latest version of ViewNX 2, which is available for download from the websites listed on page xvi, as earlier versions that do not support the D3300 may fail to transfer NEF (RAW) images correctly.

1 Launch the installer.

Start the computer, insert the installer CD, and launch the installer. A language selection dialog will be displayed. If the desired language is not available, click **Region Selection** to choose a different region (region selection is not available in the European release).

① *Select region (if required)*

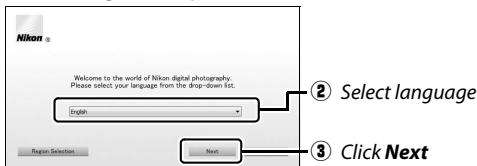

2 Start the installer.

Click **Install** and follow the on-screen instructions.



Click **Install**

3 Exit the installer.

Windows



Click **Yes**

Mac

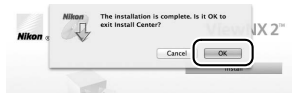

Click **OK**

4 Remove the installer CD from the CD-ROM drive.

System Requirements

	Windows	Mac
CPU	<ul style="list-style-type: none">• Photos: Intel Celeron, Pentium 4, Core Series; 1.6 GHz or better• Movies (playback): Pentium D 3.0 GHz or better; Intel Core i5 or better recommended when viewing movies with a frame size of 1280×720 or more at a frame rate of 30 fps or above or movies with a frame size of 1920×1080 or more• Movies (editing): Intel Core i5 or better	<ul style="list-style-type: none">• Photos: Intel Core or Xeon series• Movies (playback): Core Duo 2 GHz or better; Intel Core i5 or better recommended when viewing movies with a frame size of 1280×720 or more at a frame rate of 30 fps or above or movies with a frame size of 1920×1080 or more• Movies (editing): Intel Core i5 or better
OS	Pre-installed versions of Windows 8.1, Windows 7, Windows Vista, and Windows XP; note that 64-bit versions of Windows XP are not supported	OS X 10.9, 10.8, or 10.7
Memory (RAM)	<ul style="list-style-type: none">• 32-bit Windows 8.1, Windows 7, or Windows Vista: 1 GB or more (2 GB or more recommended)• 64-bit Windows 8.1, Windows 7, or Windows Vista: 2 GB or more (4 GB or more recommended)• Windows XP: 512 MB or more (2 GB or more recommended)	2 GB or more (4 GB or more recommended)
Hard disk space	A minimum of 1 GB available on the startup disk (3 GB or more recommended)	
Graphics	Resolution: 1024×768 pixels (XGA) or more (1280×1024 pixels or more recommended) Color: 24-bit color (True Color) or more	Resolution: 1024×768 pixels (XGA) or more (1280×1024 pixels or more recommended) Color: 24-bit color (millions of colors) or more

See the websites listed on page xvi for the latest information on supported operating systems.

Using ViewNX 2

Copy Pictures to the Computer

Before proceeding, be sure you have installed the software on the supplied ViewNX 2 CD (□ 82).

1 Connect the USB cable.

After turning the camera off and ensuring that a memory card is inserted, connect the supplied USB cable as shown and then turn the camera on.

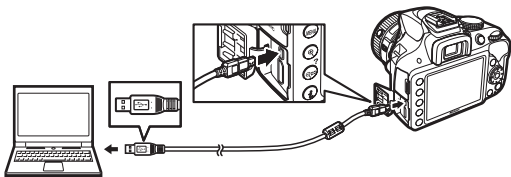

2 Start Nikon Transfer 2 component of ViewNX 2.

If a message is displayed prompting you to choose a program, select Nikon Transfer 2.

Windows 7

If the following dialog is displayed, select Nikon Transfer 2 as described below.

- 1 Under **Import pictures and videos**, click **Change program**. A program selection dialog will be displayed; select **Import File using Nikon Transfer 2** and click **OK**.



- 2 Double-click **Import File**.

3 Click **Start Transfer**.

At default settings, pictures on the memory card will be copied to the computer.



Start Transfer

During Transfer

Do not turn the camera off or disconnect the USB cable while transfer is in progress.

4 **Terminate the connection.**

When transfer is complete, turn the camera off and disconnect the USB cable.

View Pictures

Pictures are displayed in ViewNX 2 when transfer is complete.

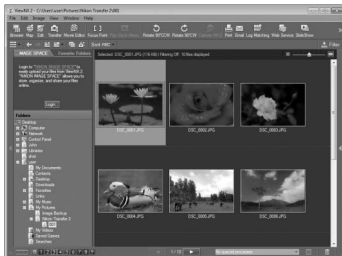

Starting ViewNX 2 Manually

- Windows: Double-click the ViewNX 2 shortcut on the desktop.
- Mac: Click the ViewNX 2 icon in the Dock.

Retouching Photographs

To crop pictures and perform such tasks as adjusting sharpness and tone levels, click the **Edit** button in the ViewNX 2 toolbar.



Editing Movies

To perform such tasks as trimming unwanted footage from movies shot with the camera, click the **Movie Editor** button in the ViewNX 2 toolbar.



■ Printing Pictures

Click the **Print** button in the ViewNX 2 toolbar. A dialog will be displayed, allowing you to print pictures on a printer connected to the computer.

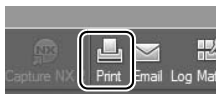

✎ For More Information

Consult online help for more information on using ViewNX 2.

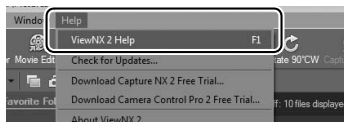

✎ Viewing the Nikon Website



To visit the Nikon website after installing ViewNX 2, select **All Programs > Link to Nikon** from the Windows start menu (Internet connection required).

Technical Notes

Read this chapter for information on compatible accessories, cleaning and storing the camera, and what to do if an error message is displayed or you encounter problems using the camera.

Compatible Lenses

This camera supports autofocus with AF-S, AF-P, and AF-I CPU lenses only. AF-S lenses have names beginning with **AF-S**, AF-P lenses with **AF-P**, and AF-I lenses with **AF-I**. Autofocus is not supported with other autofocus (AF) lenses. The following table lists the features available with compatible lenses in viewfinder photography:

Camera setting Lens/accessory	Focus			Mode		Metering		
	AF	MF (with electronic rangefinder)	MF	M	Other modes			
						3D	Color	
AF-S, AF-P, AF-I NIKKOR	✓	✓	✓	✓	✓	✓	—	✓ ¹
Other type G or D AF NIKKOR	—	✓	✓	✓	✓	✓	—	✓ ¹
PC-E NIKKOR series ^{2,3}	—	✓ ⁴	✓	✓	✓	✓	—	✓ ¹
PC Micro 85mm f/2.8D ⁵	—	✓ ⁴	✓	✓	—	✓	—	✓ ¹
AF-S / AF-I teleconverter	✓ ⁶	✓ ⁶	✓	✓	✓	✓	—	✓ ¹
Other AF NIKKOR (except lenses for F3AF)	—	✓ ⁷	✓	✓	✓	—	✓	✓ ¹
AI-P NIKKOR	—	✓ ⁸	✓	✓	✓	—	✓	✓ ¹

- 1 Spot metering meters selected focus point.
- 2 Observe due caution when tilting or shifting PC-E NIKKOR 24mm f/3.5D ED lenses, as they may contact the camera body and cause damage or injury.
- 3 Shifting and/or tilting the lens interferes with exposure.

- 4 Can not be used with shifting or tilting.
 - 5 Optimal exposure will only be achieved if the lens is at maximum aperture and the lens is not shifted or tilted.
 - 6 With maximum effective aperture of $f/5.6$ or faster.
 - 7 When AF 80–200mm $f/2.8$, AF 35–70mm $f/2.8$, AF 28–85mm $f/3.5-4.5$ (New), or AF 28–85mm $f/3.5-4.5$ lenses are zoomed all the way in at the minimum focus distance, the in-focus indicator (●) may be displayed when the image on the matte screen in the viewfinder is not in focus. Before shooting, confirm that the image in the viewfinder screen is in focus.
 - 8 With maximum aperture of $f/5.6$ or faster.
- Noise in the form of lines may appear during autofocus when movies are recorded at high ISO sensitivities. Use manual focus or focus lock.

 **IX NIKKOR Lenses**

IX NIKKOR lenses can not be used.

Other Accessories

At the time of writing, the following accessories were available for the D3300.

Power sources	<ul style="list-style-type: none">• Rechargeable Li-ion Battery EN-EL14a (□ 11): Additional EN-EL14a batteries are available from local retailers and Nikon-authorized service representatives. EN-EL14 batteries can also be used.• Battery Charger MH-24 (□ 11): Recharge EN-EL14a and EN-EL14 batteries.• Power Connector EP-5A, AC Adapter EH-5b: These accessories can be used to power the camera for extended periods (EH-5a and EH-5 AC adapters can also be used). A power connector EP-5A is required to connect the camera to the EH-5b, EH-5a, or EH-5.
Filters	<ul style="list-style-type: none">• Filters intended for special-effects photography may interfere with autofocus or the electronic rangefinder.• The D3300 can not be used with linear polarizing filters. Use C-PL or C-PL II circular polarizing filters instead.• NC filters are recommended for protecting the lens.• To prevent ghosting, use of a filter is not recommended when the subject is framed against a bright light, or when a bright light source is in the frame.• Center-weighted metering is recommended with filters with exposure factors (filter factors) over $1 \times$ (Y44, Y48, Y52, O56, R60, X0, X1, C-PL, ND2S, ND4, ND4S, ND8, ND8S, ND400, A2, A12, B2, B8, B12). See the filter manual for details.

Viewfinder eyepiece accessories	<ul style="list-style-type: none"> • DK-5 Eyepiece Cap: Prevents light entering via the viewfinder from appearing in the photograph or interfering with exposure. • DK-20C Eyepiece Correction Lenses: Lenses are available with diopters of -5, -4, -3, -2, 0, $+0.5$, $+1$, $+2$, and $+3$ m^{-1} when the camera diopter adjustment control is in the neutral position (-1 m^{-1}). Use eyepiece correction lenses only if the desired focus can not be achieved with the built in diopter adjustment control (-1.7 to $+0.5$ m^{-1}). Test eyepiece correction lenses before purchase to ensure that the desired focus can be achieved. The rubber eyecup can not be used with eyepiece correction lenses. • Magnifier DG-2: The DG-2 magnifies the scene displayed in the center of the viewfinder for greater precision during focusing. Eyepiece adapter required (available separately). • Eyepiece Adapter DK-22: The DK-22 is used when attaching the DG-2 magnifier. • Right-Angle Viewing Attachment DR-6: The DR-6 attaches at a right angle to the viewfinder eyepiece, allowing the image in the viewfinder to be viewed at right angles to the lens (for example, from directly above when the camera is horizontal).
Software	<ul style="list-style-type: none"> • Capture NX 2: A complete photo editing package offering such features as white balance adjustment and color control points. <p>Note: Use the latest versions of Nikon software. Most Nikon software offers an auto update feature (Nikon Message Center 2) when the computer is connected to the Internet. See the websites listed on page xvi for the latest information on supported operating systems.</p>

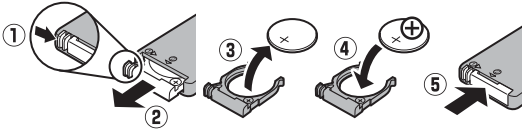
Body cap	Body Cap BF-1B/Body Cap BF-1A: The body cap keeps the mirror, viewfinder screen, and image sensor free of dust when a lens is not in place.
Accessory shoe covers	Accessory Shoe Cover BS-1: A cover protecting the accessory shoe. The accessory shoe is used for optional flash units.
Remote controls/ wireless remote controller	<ul style="list-style-type: none"> • Wireless Remote Control ML-L3 (📖 6): The ML-L3 uses a 3 V CR2025 battery.  <p>Pressing the battery-chamber latch to the right (①), insert a fingernail into the gap and open the battery chamber (②). Ensure that the battery is inserted in the correct orientation (④).</p> <ul style="list-style-type: none"> • Wireless Remote Controller WR-R10/WR-T10: When a WR-R10 wireless remote controller is attached, the camera can be controlled wirelessly using a WR-T10 wireless remote controller. • Wireless Remote Controller WR-1: WR-1 units are used in groups of two or more, with one functioning as a transmitter and the remaining units acting as receivers. The receivers are attached to the accessory terminals of one or more cameras, allowing the transmitter to be used to release the camera shutters.

Microphones Stereo Microphone ME-1

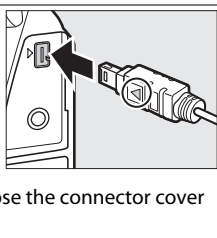
Accessory terminal accessories	<p>The D3300 is equipped with an accessory terminal for WR-1 and WR-R10 wireless remote controllers (☐ 93), MC-DC2 remote cords, and GP-1/GP-1A GPS units, which connect with the ◀ mark on the connector aligned with the ▶ next to the accessory terminal (close the connector cover when the terminal is not in use).</p>	
USB and A/V connector accessories	<ul style="list-style-type: none">• UC-E17 and UC-E6 USB cables (☐ 85): The supplied UC-E17 cable is not available for separate purchase; purchase UC-E6 cables instead.• EG-CP14 audio/video cables• Wireless Mobile Adapter WU-1a: Supports two-way communication between the camera and smart devices running the Wireless Mobile Utility.	

Optional Accessories

Availability may vary with country or region. See our website or brochures for the latest information.

Approved Memory Cards

The following SD memory cards have been tested and approved for use in the D3300. Cards with class 6 or faster write speeds are recommended for movie recording. Recording may end unexpectedly when cards with slower write speeds are used.

	SD memory cards	SDHC memory cards²	SDXC memory cards³
SanDisk	2 GB ¹	4 GB, 8 GB, 16 GB, 32 GB	64 GB
Toshiba			
Panasonic		4 GB, 6 GB, 8 GB, 12 GB, 16 GB, 24 GB, 32 GB	48 GB, 64 GB
Lexar Media		4 GB, 8 GB, 16 GB, 32 GB	—
Platinum II			64 GB
Professional			64 GB, 128 GB
Full-HD Video	—	4 GB, 8 GB, 16 GB	—

- 1 Check that any card readers or other devices with which the card will be used support 2 GB cards.
- 2 Check that any card readers or other devices with which the card will be used are SDHC-compliant. The camera supports UHS-I.
- 3 Check that any card readers or other devices with which the card will be used are SDXC-compliant. The camera supports UHS-I.



Other cards have not been tested. For more details on the above cards, please contact the manufacturer.

Caring for the Camera

Storage

When the camera will not be used for an extended period, remove the battery and store it in a cool, dry area with the terminal cover in place. To prevent mold or mildew, store the camera in a dry, well-ventilated area. Do not store your camera with naphtha or camphor moth balls or in locations that:

- are poorly ventilated or subject to humidities of over 60%
- are next to equipment that produces strong electromagnetic fields, such as televisions or radios
- are exposed to temperatures above 50 °C (122 °F) or below -10 °C (14 °F)

Cleaning

Camera body	Use a blower to remove dust and lint, then wipe gently with a soft, dry cloth. After using the camera at the beach or seaside, wipe off sand or salt with a cloth lightly dampened in distilled water and dry thoroughly. Important: <i>Dust or other foreign matter inside the camera may cause damage not covered under warranty.</i>
Lens, mirror, and viewfinder	These glass elements are easily damaged. Remove dust and lint with a blower. If using an aerosol blower, keep the can vertical to prevent the discharge of liquid. To remove fingerprints and other stains, apply a small amount of lens cleaner to a soft cloth and clean with care.
Monitor	Remove dust and lint with a blower. When removing fingerprints and other stains, wipe the surface lightly with a soft cloth or chamois leather. Do not apply pressure, as this could result in damage or malfunction.

Do not use alcohol, thinner, or other volatile chemicals.

Caring for the Camera and Battery: Cautions

Caring for the Camera

Do not drop: The product may malfunction if subjected to strong shocks or vibration.

Keep dry: This product is not waterproof, and may malfunction if immersed in water or exposed to high levels of humidity. Rusting of the internal mechanism can cause irreparable damage.

Avoid sudden changes in temperature: Sudden changes in temperature, such as those that occur when entering or leaving a heated building on a cold day, can cause condensation inside the device. To prevent condensation, place the device in a carrying case or plastic bag before exposing it to sudden changes in temperature.

Keep away from strong magnetic fields: Do not use or store this device in the vicinity of equipment that generates strong electromagnetic radiation or magnetic fields. Strong static charges or the magnetic fields produced by equipment such as radio transmitters could interfere with the monitor, damage data stored on the memory card, or affect the product's internal circuitry.

Do not leave the lens pointed at the sun: Do not leave the lens pointed at the sun or other strong light source for an extended period. Intense light may cause the image sensor to deteriorate or produce a white blur effect in photographs.

Turn the product off before removing or disconnecting the power source: Do not unplug the product or remove the battery while the product is on or while images are being recorded or deleted. Forcibly cutting power in these circumstances could result in loss of data or in damage to product memory or internal circuitry. To prevent an accidental interruption of power, avoid carrying the product from one location to another while the AC adapter is connected.

Cleaning: When cleaning the camera body, use a blower to gently remove dust and lint, then wipe gently with a soft, dry cloth. After using the camera at the beach or seaside, wipe off any sand or salt using a cloth lightly dampened in pure water and then dry the camera thoroughly.

The lens and mirror are easily damaged. Dust and lint should be gently removed with a blower. When using an aerosol blower, keep the can vertical to prevent discharge of liquid. To remove fingerprints and other stains from the lens, apply a small amount of lens cleaner to a soft cloth and wipe the lens carefully.

See the *Reference Manual* for information on cleaning the image sensor.

Do not touch the shutter curtain: The shutter curtain is extremely thin and easily damaged. Under no circumstances should you exert pressure on the curtain, poke it with cleaning tools, or subject it to powerful air currents from a blower. These actions could scratch, deform, or tear the curtain.

Storage: To prevent mold or mildew, store the camera in a dry, well-ventilated area. If you are using an AC adapter, unplug the adapter to prevent fire. If the product will not be used for an extended period, remove the battery to prevent leakage and store the camera in a plastic bag containing a desiccant. Do not, however, store the camera case in a plastic bag, as this may cause the material to deteriorate. Note that desiccant gradually loses its capacity to absorb moisture and should be replaced at regular intervals.

To prevent mold or mildew, take the camera out of storage at least once a month. Turn the camera on and release the shutter a few times before putting it away.

Store the battery in a cool, dry place. Replace the terminal cover before putting the battery away.

Notes on the monitor: The monitor is constructed with extremely high precision; at least 99.99% of pixels are effective, with no more than 0.01% being missing or defective. Hence while these displays may contain pixels that are always lit (white, red, blue, or green) or always off (black), this is not a malfunction and has no effect on images recorded with the device.

Images in the monitor may be difficult to see in a bright light.

Do not apply pressure to the monitor, as this could cause damage or malfunction. Dust or lint on the monitor can be removed with a blower. Stains can be removed by wiping lightly with a soft cloth or chamois leather. Should the monitor break, care should be taken to avoid injury from broken glass and to prevent liquid crystal from the monitor touching the skin or entering the eyes and mouth.

Moiré: Moiré is an interference pattern created by the interaction of an image containing a regular, repeating grid, such as the pattern of weave in cloth or windows in a building, with the camera image sensor grid. If you notice moiré in your photographs, try changing the distance to the subject, zooming in and out, or changing the angle between the subject and the camera.

Servicing the Camera and Accessories

The camera is a precision device and requires regular servicing. Nikon recommends that the camera be inspected by the original retailer or Nikon-authorized service representative once every one to two years, and that it be serviced once every three to five years (note that fees apply to these services). Frequent inspection and servicing are particularly recommended if the camera is used professionally. Any accessories regularly used with the camera, such as lenses or optional flash units, should be included when the camera is inspected or serviced.

Caring for the Battery

Batteries may leak or explode if improperly handled. Observe the following precautions when handling batteries:

- Use only batteries approved for use in this equipment.
- Do not expose the battery to flame or excessive heat.
- Keep the battery terminals clean.
- Turn the product off before replacing the battery.
- Remove the battery from the camera or charger when not in use and replace the terminal cover. These devices draw minute amounts of charge even when off and could draw the battery down to the point that it will no longer function. If the battery will not be used for some time, insert it in the camera and run it flat before removing it and storing it in a location with an ambient temperature of 15 °C to 25 °C (59 °F to 77 °F; avoid hot or extremely cold locations). Repeat this process at least once every six months.
- Turning the camera on and off repeatedly when the battery is fully discharged will shorten battery life. Batteries that have been fully discharged must be charged before use.
- The internal temperature of the battery may rise while the battery is in use. Attempting to charge the battery while the internal temperature is elevated will impair battery performance, and the battery may not charge or charge only partially. Wait for the battery to cool before charging.
- Continuing to charge the battery after it is fully charged can impair battery performance.



- A marked drop in the time a fully charged battery retains its charge when used at room temperature indicates that it requires replacement. Purchase a new EN-EL14a battery.
- Charge the battery before use. When taking photographs on important occasions, ready a spare EN-EL14a battery and keep it fully charged. Depending on your location, it may be difficult to purchase replacement batteries on short notice. Note that on cold days, the capacity of batteries tends to decrease. Be sure the battery is fully charged before taking photographs outside in cold weather. Keep a spare battery in a warm place and exchange the two as necessary. Once warmed, a cold battery may recover some of its charge.
- Used batteries are a valuable resource; recycle in accord with local regulations.















Error Messages







This section lists the indicators and error messages that appear in the viewfinder and monitor.



Warning Icons

A flashing  in the monitor or  in the viewfinder indicates that a warning or error message can be displayed in the monitor by pressing the  (?) button.

Indicator		Solution
Monitor	Viewfinder	
Lock lens aperture ring at minimum aperture (largest f/-number).	 (flashes)	Set lens aperture ring to minimum aperture (highest f-number).
Lens not attached	 (flashes)	<ul style="list-style-type: none">• Attach non-IX NIKKOR lens.• If non-CPU lens is attached, select mode M.
Before taking photos, rotate the zoom ring to extend the lens.	 (flashes)	A lens with a retractable lens barrel button is attached with the lens barrel retracted. Press the retractable lens barrel button and rotate the zoom ring to extend the lens.
Shutter release disabled. Recharge battery.	 (flashes)	Turn camera off and recharge or replace battery.
This battery cannot be used. Choose battery designated for use in this camera.	 (flashes)	Use Nikon-approved battery.

Indicator		Solution
Monitor	Viewfinder	
Initialization error. Turn camera off and then on again.	 / (Err) (flashes)	Turn camera off, remove and replace battery, and then turn camera on again.
Battery level is low. Complete operation and turn camera off immediately.	—	End cleaning and turn camera off and recharge or replace battery.
Clock not set	—	Set camera clock.
No memory card inserted	(-Err)/  /  (flashes)	Turn camera off and confirm that card is correctly inserted.
Memory card is locked. Slide lock to “write” position.	 (flashes)	Memory card is locked (write protected). Slide card write-protect switch to “write” position.
This memory card cannot be used. Card may be damaged. Insert another card.	 /(Err) (flashes)	<ul style="list-style-type: none"> • Use approved card. • Format card. If problem persists, card may be damaged. Contact Nikon-authorized service representative. • Error creating new folder. Delete files or insert new memory card. • Insert new memory card.
This card is not formatted. Format the card.	(Err) (flashes)	Format card or turn camera off and insert new memory card.
Card is full	Full/  /  (flashes)	<ul style="list-style-type: none"> • Reduce quality or size. • Delete photographs. • Insert new memory card.
—	● (flashes)	Camera can not focus using autofocus. Change composition or focus manually.

Indicator		Solution
Monitor	Viewfinder	
Subject is too bright	 (flashes)	<ul style="list-style-type: none"> • Use a lower ISO sensitivity. • Use commercial ND filter. • In mode: <ul style="list-style-type: none"> S Increase shutter speed A Choose a smaller aperture (higher f-number)  Choose another shooting mode
Subject is too dark		<ul style="list-style-type: none"> • Use a higher ISO sensitivity. • Use flash. • In mode: <ul style="list-style-type: none"> S Lower shutter speed A Choose a larger aperture (lower f-number)
No “Bulb” in S mode	 (flashes)	Change shutter speed or select mode M .
No “Time” in S mode	 (flashes)	
Press the live-view button when you are ready to start a panorama.	EFFECTS (flashes)/ PRno	Press the  button to start live view before recording a panorama.
Cannot shoot panorama with lens of this focal length.	—	Use a lens with a focal length of 55 mm or less to shoot panoramas. If you are using a zoom lens, choose a focal length of 55 mm or less.
—	 (flashes)	Flash has fired at full power. Check photo in monitor; if underexposed, adjust settings and try again.







Indicator		Solution
Monitor	Viewfinder	
—	 (flashes)	<ul style="list-style-type: none"> • Use the flash. • Change distance to subject, aperture, flash range, or ISO sensitivity. • Lens focal length is less than 18 mm: use a longer focal length.
Error. Press shutter release button again.	 (flashes)	Release shutter. If error persists or appears frequently, consult Nikon-authorized service representative.
Start-up error. Contact a Nikon-authorized service representative.		Consult Nikon-authorized service representative.
Metering error		
Unable to start live view. Please wait for camera to cool.	—	Wait for the internal circuits to cool before resuming live view or movie recording.
Folder contains no images.	—	Folder selected for playback contains no images (note that this message will be displayed if memory card is inserted after Current is selected for Playback folder in playback menu and playback started before any pictures are taken). Insert another memory card or select All for Playback folder .
Cannot display this file.	—	File can not be played back on camera.
Cannot select this file.	—	Images created with other devices can not be retouched.

Specifications



■ Nikon D3300 Digital Camera



Type	
Type	Single-lens reflex digital camera
Lens mount	Nikon F mount (with AF contacts)
Effective angle of view	Nikon DX format; focal length equivalent to approx. 1.5× that of lenses with FX format angle of view
Effective pixels	
Effective pixels	24.2 million
Image sensor	
Image sensor	23.5 × 15.6 mm CMOS sensor
Total pixels	24.78 million
Dust-reduction System	Image sensor cleaning, Image Dust Off reference data (optional Capture NX 2 software required)
Storage	
Image size (pixels)	<ul style="list-style-type: none">•  (easy panorama) mode:<ul style="list-style-type: none">- Normal, horizontal pan: 4800 × 1080- Normal, vertical pan: 1632 × 4800- Wide, horizontal pan: 9600 × 1080- Wide, vertical pan: 1632 × 9600• Other modes:<ul style="list-style-type: none">- 6000 × 4000 (Large)- 4496 × 3000 (Medium)- 2992 × 2000 (Small)
File format	<ul style="list-style-type: none">• NEF (RAW): 12 bit, compressed• JPEG: JPEG-Baseline compliant with fine (approx. 1 : 4), normal (approx. 1 : 8), or basic (approx. 1 : 16) compression• NEF (RAW)+JPEG: Single photograph recorded in both NEF (RAW) and JPEG formats

Storage	
Picture Control System	Standard, Neutral, Vivid, Monochrome, Portrait, Landscape; selected Picture Control can be modified
Media	SD (Secure Digital) and UHS-I compliant SDHC and SDXC memory cards
File system	DCF 2.0, DPOF, Exif 2.3, PictBridge
Viewfinder	
Viewfinder	Eye-level pentamirror single-lens reflex viewfinder
Frame coverage	Approx. 95% horizontal and 95% vertical
Magnification	Approx. $0.85 \times$ (50 mm f/1.4 lens at infinity, -1.0 m^{-1})
Eyepoint	18 mm (-1.0 m^{-1} ; from center surface of viewfinder eyepiece lens)
Diopter adjustment	$-1.7 - +0.5 \text{ m}^{-1}$
Focusing screen	Type B BriteView Clear Matte Mark VII screen
Reflex mirror	Quick return
Lens aperture	Instant return, electronically controlled
Lens	
Compatible lenses	<p>Autofocus is available with AF-S, AF-P, and AF-I lenses. Autofocus is not available with other type G and D lenses, AF lenses (IX NIKKOR and lenses for the F3AF are not supported), and AI-P lenses. Non-CPU lenses can be used in mode M, but the camera exposure meter will not function.</p> <p>The electronic rangefinder can be used with lenses that have a maximum aperture of f/5.6 or faster.</p>

Shutter	
Type	Electronically-controlled vertical-travel focal-plane shutter
Speed	$\frac{1}{4000}$ – 30 s in steps of $\frac{1}{3}$ EV; Bulb; Time
Flash sync speed	X= $\frac{1}{200}$ s; synchronizes with shutter at $\frac{1}{200}$ s or slower
Release	
Release mode	 (single frame),  (continuous),  (quiet shutter release),  (self-timer),  2s (delayed remote; ML-L3),  (quick-response remote; ML-L3)
Frame advance rate	Up to 5 fps Note: Frame rates assume manual focus, manual or shutter-priority auto exposure, a shutter speed of $\frac{1}{250}$ s or faster, and other settings at default values.
Self-timer	2 s, 5 s, 10 s, 20 s; 1–9 exposures
Exposure	
Metering mode	TTL exposure metering using 420-pixel RGB sensor
Metering method	<ul style="list-style-type: none"> • Matrix metering: 3D color matrix metering II (type G, E, and D lenses); color matrix metering II (other CPU lenses) • Center-weighted metering: Weight of 75% given to 8-mm circle in center of frame • Spot metering: Meters 3.5-mm circle (about 2.5% of frame) centered on selected focus point
Range (ISO 100, f/1.4 lens, 20 °C/68 °F)	<ul style="list-style-type: none"> • Matrix or center-weighted metering: 0–20 EV • Spot metering: 2–20 EV
Exposure meter coupling	CPU

Exposure	
Mode	Auto modes (AUTO auto; auto, flash off); programmed auto with flexible program (P); shutter-priority auto (S); aperture-priority auto (A); manual (M); scene modes (portrait; landscape; child; sports; close up; night portrait); special effects modes (night vision; VI super vivid; POP pop; photo illustration; color sketch; toy camera effect; miniature effect; selective color; silhouette; high key; low key; HDR painting; easy panorama)
Exposure compensation	Can be adjusted by -5 – +5 EV in increments of 1/3 EV in P, S, A, and M modes
Exposure lock	Luminosity locked at detected value with (O-m) button
ISO sensitivity (Recommended Exposure Index)	ISO 100 – 12800 in steps of 1 EV. Can also be set to approx. 1 EV (ISO 25600 equivalent) above ISO 12800; auto ISO sensitivity control available
Active D-Lighting	On, off
Focus	
Autofocus	Nikon Multi-CAM 1000 autofocus sensor module with TTL phase detection, 11 focus points (including one cross-type sensor), and AF-assist illuminator (range approx. 0.5–3 m/1 ft 8 in.–9 ft 10 in.)
Detection range	-1 – +19 EV (ISO 100, 20 °C/68 °F)

Focus	
Lens servo	<ul style="list-style-type: none"> • Autofocus (AF): Single-servo AF (AF-S); continuous-servo AF (AF-C); auto AF-S/AF-C selection (AF-A); predictive focus tracking activated automatically according to subject status • Manual focus (MF): Electronic rangefinder can be used
Focus point	Can be selected from 11 focus points
AF-area mode	Single-point AF, dynamic-area AF, auto-area AF, 3D-tracking (11 points)
Focus lock	Focus can be locked by pressing shutter-release button halfway (single-servo AF) or by pressing AE-L/AF-L () button
Flash	
Built-in flash	 : Auto flash with auto pop-up P, S, A, M: Manual pop-up with button release
Guide Number	Approx. 12/39, 12/39 with manual flash (m/ft, ISO 100, 20 °C/68 °F)
Flash control	TTL: i-TTL flash control using 420-pixel RGB sensor is available with built-in flash and SB-910, SB-900, SB-800, SB-700, SB-600, SB-400, or SB-300; i-TTL balanced fill-flash for digital SLR is used with matrix and center-weighted metering, standard i-TTL flash for digital SLR with spot metering
Flash mode	Auto, auto with red-eye reduction, auto slow sync, auto slow sync with red-eye reduction, fill-flash, red-eye reduction, slow sync, slow sync with red-eye reduction, rear-curtain with slow sync, rear-curtain sync, off

Flash	
Flash compensation	-3 – +1 EV in increments of 1/3 EV
Flash-ready indicator	Lights when built-in flash or optional flash unit is fully charged; flashes after flash is fired at full output
Accessory shoe	ISO 518 hot-shoe with sync and data contacts and safety lock
Nikon Creative Lighting System (CLS)	Advanced Wireless Lighting supported with SB-910, SB-900, SB-800, or SB-700 as a master flash or SU-800 as commander; Flash Color Information Communication supported with all CLS-compatible flash units
Sync terminal	AS-15 sync terminal adapter (available separately)
White balance	
White balance	Auto, incandescent, fluorescent (7 types), direct sunlight, flash, cloudy, shade, preset manual, all except preset manual with fine-tuning
Live view	
Lens servo	<ul style="list-style-type: none"> • Autofocus (AF): Single-servo AF (AF-S); full-time-servo AF (AF-F) • Manual focus (MF)
AF-area mode	Face-priority AF, wide-area AF, normal-area AF, subject-tracking AF
Autofocus	Contrast-detect AF anywhere in frame (camera selects focus point automatically when face-priority AF or subject-tracking AF is selected)
Automatic scene selection	Available in  and  modes

Movie	
Metering	TTL exposure metering using main image sensor
Metering method	Matrix
Frame size (pixels) and frame rate	<ul style="list-style-type: none"> • 1920 × 1080, 60p (progressive)/50p/30p/25p/24p, ★ high/normal • 1280 × 720, 60p/50p, ★ high/normal • 640 × 424, 30p/25p, ★ high/normal <p>Frame rates of 30p (actual frame rate 29.97 fps) and 60p (actual frame rate 59.94 fps) are available when NTSC is selected for video mode. 25p and 50p are available when PAL is selected for video mode. Actual frame rate when 24p is selected is 23.976 fps.</p>
File format	MOV
Video compression	H.264/MPEG-4 Advanced Video Coding
Audio recording format	Linear PCM
Audio recording device	Built-in monaural or external stereo microphone; sensitivity adjustable
ISO sensitivity	ISO 100–12800; can also be set to approx. 1 EV (ISO 25600 equivalent) above ISO 12800
Monitor	
Monitor	7.5-cm (3-in.), approx. 921k-dot (VGA) TFT LCD with 170 ° viewing angle, approx. 100% frame coverage, and brightness adjustment
Playback	
Playback	Full-frame and thumbnail (4, 9, or 72 images or calendar) playback with playback zoom, movie and panorama playback, photo and/or movie slide shows, histogram display, highlights, auto image rotation, picture rating, and image comment (up to 36 characters)

Interface	
USB	Hi-Speed USB
Video output	NTSC, PAL
HDMI output	Type C mini-pin HDMI connector
Accessory terminal	Wireless remote controllers: WR-1, WR-R10 (available separately) Remote cords: MC-DC2 (available separately) GPS units: GP-1/GP-1A (available separately)
Audio input	Stereo mini-pin jack (3.5mm diameter); supports optional ME-1 stereo microphones
Supported languages	
Supported languages	Arabic, Bengali, Bulgarian, Chinese (Simplified and Traditional), Czech, Danish, Dutch, English, Finnish, French, German, Greek, Hindi, Hungarian, Indonesian, Italian, Japanese, Korean, Marathi, Norwegian, Persian, Polish, Portuguese (Portugal and Brazil), Romanian, Russian, Serbian, Spanish, Swedish, Tamil, Telugu, Thai, Turkish, Ukrainian, Vietnamese
Power source	
Battery	One rechargeable Li-ion EN-EL14a battery
AC adapter	EH-5b AC adapter; requires EP-5A power connector (available separately)
Tripod socket	
Tripod socket	1/4 in. (ISO 1222)

Dimensions/weight	
Dimensions (W × H × D)	Approx. 124 × 98 × 75.5 mm (4.9 × 3.9 × 3 in.)
Weight	Approx. 460 g (1 lb 0.2 oz) with battery and memory card but without body cap; approx. 410 g/14.5 oz (camera body only)
Operating environment	
Temperature	0 °C–40 °C (+32 °F–104 °F)
Humidity	85% or less (no condensation)

- Unless otherwise stated, all measurements are performed in conformity with Camera and Imaging Products Association (CIPA) standards or guidelines.
- All figures are for a camera with a fully-charged battery.
- Nikon reserves the right to change the appearance and specifications of the hardware and software described in this manual at any time and without prior notice. Nikon will not be held liable for damages that may result from any mistakes that this manual may contain.

■ ■ *MH-24 Battery Charger*

Rated input	AC 100–240 V, 50/60 Hz, 0.2 A maximum
Rated output	DC 8.4 V/0.9 A
Supported batteries	Nikon Rechargeable Li-ion Battery EN-EL14a
Charging time	Approx. 1 hour and 50 minutes at an ambient temperature of 25 °C/77 °F when no charge remains
Operating temperature	0 °C–40 °C (+32 °F–104 °F)
Dimensions (W × H × D)	Approx. 70 × 26 × 97 mm (2.8 × 1.0 × 3.8 in.), excluding plug adapter
Weight	Approx. 96 g (3.4 oz), excluding plug adapter

■ ■ *EN-EL14a Rechargeable Li-ion Battery*

Type	Rechargeable lithium-ion battery
Rated capacity	7.2 V/1230 mAh
Operating temperature	0 °C–40 °C (+32 °F–104 °F)
Dimensions (W × H × D)	Approx. 38 × 53 × 14 mm (1.5 × 2.1 × 0.6 in.)
Weight	Approx. 49 g (1.7 oz), excluding terminal cover

■ AF-P DX NIKKOR 18–55mm f/3.5–5.6G VR and AF-P DX NIKKOR 18–55mm f/3.5–5.6G Lenses

Type	Type G AF-P DX lens with built-in CPU and F mount
Focal length	18–55 mm
Maximum aperture	f/3.5–5.6
Lens construction	12 elements in 9 groups (2 aspherical lens elements)
Angle of view	76° – 28° 50′
Focal length scale	Graduated in millimeters (18, 24, 35, 45, 55)
Distance information	Output to camera
Zoom	Manual zoom using independent zoom ring
Focusing	Autofocus controlled by stepping motor; separate focus ring for manual focus
Vibration reduction (AF-P DX NIKKOR 18–55mm f/3.5–5.6G VR only)	Lens shift using voice coil motors (VCMs)
Minimum focus distance	0.25 m (0.9 ft) from focal plane at all zoom positions
Diaphragm blades	7 (rounded diaphragm opening)
Diaphragm	Fully automatic
Aperture range	<ul style="list-style-type: none"> • 18 mm focal length: f/3.5–22 • 55 mm focal length: f/5.6–38 <p>The minimum aperture displayed may vary depending on the size of the exposure increment selected with the camera.</p>
Metering	Full aperture
Filter-attachment size	55 mm (P = 0.75 mm)
Dimensions	Approx. 64.5 mm maximum diameter × 62.5 mm (distance from camera lens-mount flange when lens is retracted)
Weight	<ul style="list-style-type: none"> • AF-P DX NIKKOR 18–55mm f/3.5–5.6G VR: Approx. 205 g (7.3 oz) • AF-P DX NIKKOR 18–55mm f/3.5–5.6G: Approx. 195 g (6.9 oz)

■ AF-S DX NIKKOR 18–55mm f/3.5–5.6G VR II Lens

Type	Type G AF-S DX lens with built-in CPU and F mount
Focal length	18–55 mm
Maximum aperture	f/3.5–5.6
Lens construction	11 elements in 8 groups (including 1 aspherical lens element)
Angle of view	76°–28° 50′
Focal length scale	Graduated in millimeters (18, 24, 35, 45, 55)
Distance information	Output to camera
Zoom	Manual zoom using independent zoom ring
Focusing	Autofocus controlled by Silent Wave Motor and separate focus ring for manual focus
Vibration reduction	Lens shift using voice coil motors (VCMs)
Minimum focus distance	<ul style="list-style-type: none">• AF: 0.28 m (0.92 ft) from focal plane at all zoom positions• MF: 0.25 m (0.82 ft) from focal plane at all zoom positions
Diaphragm blades	7 (rounded diaphragm opening)
Diaphragm	Fully automatic
Aperture range	<ul style="list-style-type: none">• 18 mm focal length: f/3.5–22• 55 mm focal length: f/5.6–38 The minimum aperture displayed may vary depending on the size of the exposure increment selected with the camera.
Metering	Full aperture
Filter-attachment size	52 mm (P=0.75 mm)
Dimensions	Approx. 66 mm diameter × 59.5 mm (distance from camera lens-mount flange when lens is retracted)
Weight	Approx. 195 g (6.9 oz)

Nikon reserves the right to change the appearance and specifications of the hardware and software described in this manual at any time and without prior notice. Nikon will not be held liable for damages that may result from any mistakes that this manual may contain.

AF-P DX NIKKOR 18–55mm f/3.5–5.6G VR, AF-P DX NIKKOR 18–55mm f/3.5–5.6G
AF-P DX NIKKOR 18–55mm f/3.5–5.6G VR and AF-P DX NIKKOR
18–55mm f/3.5–5.6G feature retractable lens barrels.

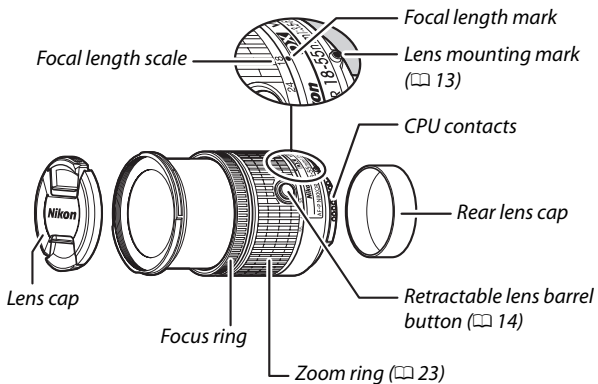

■ The AF-S DX NIKKOR 18–55mm f/3.5–5.6G VR II

The lens generally used in this manual for illustrative purposes is the AF-S DX NIKKOR 18–55mm f/3.5–5.6G VR II, which features a retractable lens barrel.

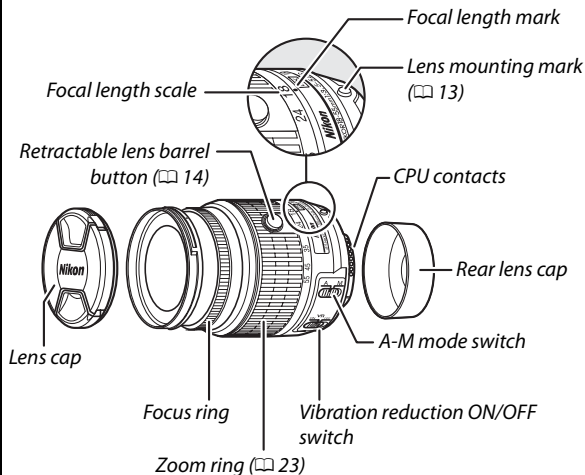

Trademark Information

IOS is a trademark or registered trademark of Cisco Systems, Inc., in the United States and/or other countries and is used under license. Mac OS and OS X are registered trademarks of Apple Inc. in the United States and/or other countries. Microsoft, Windows, and Windows Vista are either registered trademarks, or trademarks of Microsoft Corporation in the United States and/or other countries. PictBridge logo is a trademark. The SD, SDHC, and SDXC logos are trademarks of the SD-3C, LLC. HDMI, the HDMI logo and High-Definition Multimedia Interface are trademarks or registered trademarks of HDMI Licensing LLC.

HDMI

All other trade names mentioned in this manual or the other documentation provided with your Nikon product are trademarks or registered trademarks of their respective holders.

FreeType License (FreeType2)

Portions of this software are copyright © 2014 The FreeType Project (<http://www.freetype.org>). All rights reserved.

MIT License (HarfBuzz)

Portions of this software are copyright © 2014 The HarfBuzz Project (<http://www.freedesktop.org/wiki/Software/HarfBuzz>). All rights reserved.

Battery Life

The movie footage or number of shots that can be recorded with fully-charged batteries varies with the condition of the battery, temperature, the interval between shots, and the length of time menus are displayed. Sample figures for EN-EL14a (1230 mAh) batteries are given below.

- **Photographs, single-frame release mode (CIPA standard ¹):**
Approximately 700 shots
 - **Photographs, continuous release mode (Nikon standard ²):**
Approximately 2500 shots
 - **Movies:** Approximately 55 minutes at 1080/60p and 1080/50p³
- 1 Measured at 23 °C/73.4 °F (± 2 °C/3.6 °F) with an AF-S DX NIKKOR 18–55mm f/3.5–5.6G VR II lens under the following test conditions: lens cycled from infinity to minimum range and one photograph taken at default settings once every 30 s; after photograph is taken, monitor is turned on for 4 s; tester waits for standby timer to expire after monitor is turned off; flash fired at full power once every other shot. Live view not used.
 - 2 Measured at 20 °C/68 °F with an AF-S DX NIKKOR 18–55mm f/3.5–5.6G VR II lens under the following test conditions: vibration reduction off, continuous release mode, focus mode set to **AF-C**, image quality set to JPEG basic, image size set to **M** (medium), white balance set to **AUTO**, ISO sensitivity set to ISO 100, shutter speed $\frac{1}{250}$ s, focus cycled from infinity to minimum range three times after shutter-release button has been pressed halfway for 3 s; six shots are then taken in succession and monitor turned on for 4 s and then turned off; cycle repeated once standby timer has expired.
 - 3 Measured at 23 °C/73.4 °F (± 2 °C/3.6 °F) with the camera at default settings and an AF-S DX NIKKOR 18–55mm f/3.5–5.6G VR II lens under conditions specified by the Camera and Imaging Products Association (CIPA). Individual movies can be up to 20 minutes in length or 4 GB in size; recording may end before these limits are reached if the camera temperature rises.

The following can reduce battery life:

- Using the monitor
- Keeping the shutter-release button pressed halfway
- Repeated autofocus operations
- Taking NEF (RAW) photographs
- Slow shutter speeds
- Using a GP-1 or GP-1A GPS unit
- Using an Eye-Fi card
- Using a WU-1a wireless mobile adapter
- Using VR (vibration reduction) mode with VR lenses
- Repeatedly zooming in and out with an AF-P lens.

To ensure that you get the most from rechargeable Nikon EN-EL14a batteries:

- Keep the battery contacts clean. Soiled contacts can reduce battery performance.
- Use batteries immediately after charging. Batteries will lose their charge if left unused.

Warranty Terms - Nikon Europe Service Warranty

Dear Nikon Customer,

We thank you for your purchasing this Nikon product. Should your Nikon product require warranty service, please contact the dealer from whom it was purchased or a member of our authorized service network within the sales territory of Nikon Europe B.V. (e.g. Europe/Russia/others). See details under: <http://www.europe-nikon.com/support>

In order to avoid any unnecessary inconvenience, we advise you to read the user manuals carefully before contacting the dealer or our authorized service network.

Your Nikon equipment is guaranteed against any manufacturing defects for one full year from the date of original purchase. If during this period of guarantee the product proves defective due to improper material or workmanship, our authorized service network within the sales territory of Nikon Europe B.V. will, without charge for labor and parts, repair the product in the terms and conditions set as below. Nikon reserves the right (at its sole discretion) to replace or repair the product.

1. This warranty is only provided upon presentation of the completed warranty card and original invoice or purchase receipt indicating the date of purchase, product type and dealer's name, together with the product. Nikon reserves the right to refuse free-of-charge warranty service if the above documents cannot be presented or if the information contained in it is incomplete or illegible.

2. This warranty will not cover:

- necessary maintenance and repair or replacement of parts due to normal wear and tear.
- modifications to upgrade the product from its normal purpose as described in user manuals, without the prior written consent of Nikon.
- transport costs and all risks of transport relating directly or indirectly to the warranty of the products.
- any damage resulting from modifications or adjustments which may be made to the product, without the prior written consent of Nikon, in order to comply with local or national technical standards in force in any other country than the ones for which the product was originally designed and/or manufactured.

3. The warranty will not be applicable in the case of:

- damage caused by misuse including but not limited to failure to use the product for its normal purpose or according to the user instructions on the proper use and maintenance, and to installation or use of the product inconsistent with the safety standards in force in the country where it is used.
- damage caused by accidents including but not limited to lightning, water, fire, misuse or neglect.
- defacing, illegibility or removal of the model or serial number on the product.
- damage resulting from repairs or adjustments which have been conducted by unauthorized service organizations or persons.
- defects in any system into which the product is incorporated or with which it is used.

4. This service warranty does not affect the consumer's statutory rights under applicable national laws in force, nor the consumer's right against the dealer arising from their sales/purchase contract.

Notice: An overview of all authorized Nikon Service Stations can be found online by following this Link
(URL = <http://www.europe-nikon.com/service/>).



No reproduction in any form of this manual, in whole or in part (except for brief quotation in critical articles or reviews), may be made without written authorization from NIKON CORPORATION.

Nikon User Support

Visit the site below to register your camera and keep up-to-date with the latest product information. You will find answers to frequently asked questions (FAQs) and can contact us for technical assistance.

<http://www.europe-nikon.com/support>