

Nikon

DIGITAL CAMERA









D5300

Reference Manual

Thank you for your purchase of a Nikon single-lens reflex (SLR) digital camera. To get the most from your camera, please be sure to read all instructions thoroughly and keep them where they will be read by all who use the product.




Where to Find It

Find what you're looking for from:

 The Table of Contents  i	 Error Messages  256
 Troubleshooting  251	 The Index  283

Symbols and Conventions

To make it easier to find the information you need, the following symbols and conventions are used:

-  This icon marks cautions; information that should be read before use to prevent damage to the camera.
-  This icon marks notes; information that should be read before using the camera.
-  This icon marks references to other pages in this manual.

Menu items, options, and messages displayed in the camera monitor are shown in **bold**.

Camera Settings

The explanations in this manual assume that default settings are used.

Help

Use the camera's on-board help feature for help on menu items and other topics. See page 8 for details.


 **For Your Safety**
Before using the camera for the first time, read the safety instructions in "For Your Safety" (□ viii–xiv).

Table of Contents

For Your Safety	viii
Notices	xi
Location Data	xv
Wireless	xvi












Introduction **1**

Getting to Know the Camera.....	1
The Camera Body.....	1
The Mode Dial.....	3
The Viewfinder.....	4
The Monitor	5
The Information Display.....	6
Camera Menus: An Overview	8
First Steps	11

“Point-and-Shoot” Modes (AUTO and) **19**

Framing Photos in the Viewfinder.....	20
Viewing Photographs.....	22
Deleting Unwanted Pictures.....	22
Framing Photos in the Monitor	24
Viewing Photographs.....	26
Deleting Unwanted Pictures.....	26
Recording Movies	27
Viewing Movies.....	28
Deleting Unwanted Movies	29

Matching Settings to the Subject or Situation (Scene Mode) **30**

The Mode Dial	31
 Portrait.....	31
 Landscape.....	31
 Child.....	31
 Sports.....	32
 Close up	32
Other Scenes.....	33
 Night Portrait	33
 Night Landscape.....	33
 Party/Indoor	34
 Beach/Snow	34
 Sunset.....	34
 Dusk/Dawn	35

Pet Portrait	35
Candlelight	35
Blossom	36
Autumn Colors	36
Food	36

Special Effects **37**

Night Vision	37
Color Sketch	38
Toy Camera Effect	38
Miniature Effect	38
Selective Color	39
Silhouette	39
High Key	39
Low Key	40
HDR Painting	40
Options Available in Live View	41

More on Photography **45**

Choosing a Release Mode	45
Continuous Shooting (Burst Mode)	46
Quiet Shutter Release	48
Self-Timer Mode	49
Focus (Viewfinder Photography)	51
Choosing How the Camera Focuses: Focus Mode	51
Choosing How the Focus Point Is Selected: AF-Area Mode	53
Focus Point Selection	55
Focus Lock	55
Manual Focus	57
Image Quality and Size	59
Image Quality	59
Image Size	61
Using the Built-in Flash	62
Auto Pop-up Modes	62
Manual Pop-up Modes	64
ISO Sensitivity	67
Interval Timer Photography	68
Remote Control Photography	70
Using an Optional ML-L3 Remote Control	70
Restoring Default Settings	72

Location Data	74
Embedding Location Data in Photos and Movies.....	74
Track Logs.....	76
Deleting Logs	78
GPS Options	79

P, S, A, and M Modes **82**

Shutter Speed and Aperture.....	82
Mode P (Programmed Auto)	84
Mode S (Shutter-Priority Auto)	85
Mode A (Aperture-Priority Auto).....	86
Mode M (Manual).....	87
Long Time-Exposures (M Mode Only)	88
Exposure	90
Metering.....	90
Autoexposure Lock	91
Exposure Compensation	92
Flash Compensation	93
Preserving Detail in Highlights and Shadows	94
Active D-Lighting.....	94
High Dynamic Range (HDR)	96
Multiple Exposure.....	98
White Balance	101
Fine-Tuning White Balance	103
Preset Manual.....	104
Bracketing	108
Picture Controls.....	111
Selecting a Picture Control	111
Modifying Picture Controls	112
Creating Custom Picture Controls	115
Sharing Custom Picture Controls.....	117

Live View **118**

Framing Photographs in the Monitor	118
Focusing in Live View	119
The Live View Display	122

Recording and Viewing Movies **126**

Recording Movies	126
Movie Settings	128
Viewing Movies	130

Editing Movies	131
Trimming Movies	131
Saving Selected Frames	134

Playback and Deletion **135**

Full-Frame Playback.....	135
Photo Information.....	136
Thumbnail Playback	140
Calendar Playback	141
Taking a Closer Look: Playback Zoom.....	142
Protecting Photographs from Deletion.....	143
Rating Pictures.....	144
Rating Individual Pictures.....	144
Rating Multiple Pictures	145
Deleting Photographs	146
Full-Frame, Thumbnail, and Calendar Playback.....	146
The Playback Menu.....	147
Slide Shows.....	149
Slide Show Options.....	150

Connections **151**

Installing ViewNX 2	151
Using ViewNX 2	153
Copy Pictures to the Computer	153
View Pictures.....	154
Printing Photographs.....	156
Connecting the Printer	156
Printing Pictures One at a Time.....	157
Printing Multiple Pictures.....	159
Creating a DPOF Print Order: Print Set	162
Viewing Pictures on TV	164
Standard Definition Devices.....	164
High-Definition Devices	165

Wi-Fi **167**

What Wi-Fi Can Do for You.....	167
Accessing the Camera.....	168
WPS (Android Only)	169
PIN Entry (Android Only).....	170
SSID (Android and iOS).....	171

Selecting Pictures for Upload	173
Selecting Individual Pictures for Upload	173
Selecting Multiple Pictures for Upload	174

Camera Menus

175

▶ The Playback Menu: <i>Managing Images</i>	175
Playback Folder	175
Playback Display Options	176
Image Review	176
Rotate Tall	176
📷 The Shooting Menu: <i>Shooting Options</i>	177
Reset Shooting Menu	177
Storage Folder	178
NEF (RAW) Recording.....	178
Auto Distortion Control	179
Color Space.....	179
Long Exposure NR.....	179
High ISO NR.....	180
ISO Sensitivity Settings.....	180
Optical VR.....	181
✎ Custom Settings: <i>Fine-Tuning Camera Settings</i>	182
Reset Custom Settings.....	183
a: Autofocus	184
a1: AF-C Priority Selection	184
a2: Number of Focus Points	184
a3: Built-in AF-assist Illuminator.....	185
a4: Rangefinder	185
b: Exposure.....	186
b1: EV Steps for Exposure Cntrl	186
c: Timers/AE Lock	186
c1: Shutter-Release Button AE-L	186
c2: Auto off Timers	186
c3: Self-Timer.....	187
c4: Remote on Duration (ML-L3)	187
d: Shooting/Display.....	187
d1: Beep	187
d2: Viewfinder Grid Display	188
d3: ISO Display.....	188
d4: File Number Sequence	188
d5: Exposure Delay Mode.....	189
d6: Print Date	190
e: Bracketing/Flash	192
e1: Flash Cntrl for Built-in Flash	192
e2: Auto Bracketing Set	192

f: Controls	193
f1: Assign Fn Button	193
f2: Assign AE-L/AF-L Button	194
f3: Reverse Dial Rotation.....	194
f4: Slot Empty Release Lock.....	194
f5: Reverse Indicators.....	194
☛ The Setup Menu: <i>Camera Setup</i>	195
Format Memory Card	196
Monitor Brightness.....	196
Info Display Format.....	197
Auto Info Display.....	199
Image Dust Off Ref Photo	199
Flicker Reduction.....	200
Time Zone and Date	201
Language	201
Auto Image Rotation	202
Image Comment	202
Video Mode.....	202
Remote Control	203
Eye-Fi Upload	204
Conformity Marking.....	204
Firmware Version	204
☛ The Retouch Menu: <i>Creating Retouched Copies</i>	205
Creating Retouched Copies	206
D-Lighting.....	207
Red-Eye Correction.....	207
Trim	208
Monochrome	208
Filter Effects.....	209
Color Balance.....	210
Image Overlay.....	211
NEF (RAW) Processing	213
Resize.....	214
Quick Retouch.....	215
Straighten	215
Distortion Control.....	215
Fisheye	216
Color Outline	216
Color Sketch.....	216
Perspective Control.....	217
Miniature Effect	218
Selective Color	219
Side-by-side Comparison.....	221
☛ Recent Settings/☑ My Menu.....	222
Choosing a Menu.....	222
☑ Recent Settings	222
☑ My Menu.....	223

Compatible Lenses.....	226
Compatible CPU Lenses	226
Compatible Non-CPU Lenses	228
Optional Flash Units (Speedlights).....	232
Flash Units Compatible with the Creative Lighting System (CLS).....	232
Other Accessories	236
Approved Memory Cards.....	238
Attaching a Power Connector and AC Adapter	239
Caring for the Camera.....	240
Storage.....	240
Cleaning	240
Image Sensor Cleaning.....	241
Caring for the Camera and Battery: Cautions.....	245
Caring for the Camera	245
Caring for the Battery	246
Available Settings	248
Troubleshooting	251
Battery/Display	251
Shooting (All Modes)	251
Shooting (P, S, A, M).....	253
Playback	253
Location Data	255
Wi-Fi (Wireless Networks)	255
Miscellaneous.....	255
Error Messages.....	256
Specifications	259
Lens Kits	266
AF-P DX NIKKOR 18–55mm f/3.5–5.6G VR and AF-P DX NIKKOR 18–55mm f/3.5–5.6G.....	266
AF-S DX NIKKOR 18–55mm f/3.5–5.6G VR II.....	271
AF-S DX NIKKOR 18–140mm f/3.5–5.6G ED VR.....	275
Memory Card Capacity	281
Battery Life	282
Index.....	283

For Your Safety

To prevent damage to your Nikon product or injury to yourself or to others, read the following safety precautions in their entirety before using this equipment. Keep these safety instructions where all those who use the product will read them.

The consequences that could result from failure to observe the precautions listed in this section are indicated by the following symbol:



This icon marks warnings. To prevent possible injury, read all warnings before using this Nikon product.

■ ■ WARNINGS

Keep the sun out of the frame

Keep the sun well out of the frame when shooting backlit subjects. Sunlight focused into the camera when the sun is in or close to the frame could cause a fire.

Do not look at the sun through the viewfinder

Viewing the sun or other strong light source through the viewfinder could cause permanent visual impairment.

Using the viewfinder diopter adjustment control

When operating the viewfinder diopter adjustment control with your eye to the viewfinder, care should be taken not to put your finger in your eye accidentally.

Turn off immediately in the event of malfunction

Should you notice smoke or an unusual smell coming from the equipment or AC adapter (available separately), unplug the AC adapter and remove the battery immediately, taking care to avoid burns. Continued operation could result in injury. After removing the battery, take the equipment to a Nikon-authorized service center for inspection.

Do not use in the presence of flammable gas

Do not use electronic equipment in the presence of flammable gas, as this could result in explosion or fire.

Keep out of reach of children

Failure to observe this precaution could result in injury. In addition, note that small parts constitute a choking hazard. Should a child swallow any part of this equipment, consult a physician immediately.

Do not disassemble

Touching the product's internal parts could result in injury. In the event of malfunction, the product should be repaired only by a qualified technician. Should the product break open as the result of a fall or other accident, remove the battery and/or AC adapter and then take the product to a Nikon-authorized service center for inspection.


Do not place the strap around the neck of an infant or child

Placing the camera strap around the neck of an infant or child could result in strangulation.

Do not remain in contact with the camera, battery, or charger for extended periods while the devices are on or in use

Parts of the device become hot. Leaving the device in direct contact with the skin for extended periods may result in low-temperature burns.

- ⚠ **Do not leave the product where it will be exposed to extremely high temperatures, such as in an enclosed automobile or in direct sunlight**
Failure to observe this precaution could cause damage or fire.
- ⚠ **Do not aim a flash at the operator of a motor vehicle**
Failure to observe this precaution could result in accidents.
- ⚠ **Observe caution when using the flash**
 - Using the camera with the flash in close contact with the skin or other objects could cause burns.
 - Using the flash close to the subject's eyes could cause temporary visual impairment. The flash should be no less than one meter (3 ft 4 in.) from the subject. Particular care should be observed when photographing infants.
- ⚠ **Avoid contact with liquid crystal**
Should the monitor break, care should be taken to avoid injury due to broken glass and to prevent the liquid crystal from the monitor touching the skin or entering the eyes or mouth.
- ⚠ **Do not carry tripods with a lens or camera attached**
You could trip or accidentally strike others, resulting in injury.
- ⚠ **Observe proper precautions when handling batteries**
Batteries may leak, overheat, rupture, or catch fire if improperly handled. Observe the following precautions when handling batteries for use in this product:
 - Use only batteries approved for use in this equipment.
 - Do not short or disassemble the battery.
 - Do not expose the battery or the camera in which it is inserted to powerful physical shocks.
 - Be sure the product is off before replacing the battery. If you are using an AC adapter, be sure it is unplugged.
 - Do not attempt to insert the battery upside down or backwards.
- Do not expose the battery to flame or to excessive heat.
- Do not immerse in or expose to water.
- Replace the terminal cover when transporting the battery. Do not transport or store the battery with metal objects such as necklaces or hairpins.
- Batteries are prone to leakage when fully discharged. To avoid damage to the product, be sure to remove the battery when no charge remains.
- When the battery is not in use, attach the terminal cover and store in a cool, dry place.
- The battery may be hot immediately after use or when the product has been used on battery power for an extended period. Before removing the battery turn the camera off and allow the battery to cool.
- Discontinue use immediately should you notice any changes in the battery, such as discoloration or deformation.

 **Observe proper precautions when handling the charger**


- Keep dry. Failure to observe this precaution could result in fire or electric shock.
- Do not short the charger terminals. Failure to observe this precaution could result in overheating and damage to the charger.
- Dust on or near the metal parts of the plug should be removed with a dry cloth. Continued use could result in fire.
- Do not go near the charger during thunderstorms. Failure to observe this precaution could result in electric shock.
- Do not handle the plug or charger with wet hands. Failure to observe this precaution could result in electric shock.
- Do not use with travel converters or adapters designed to convert from one voltage to another or with DC-to-AC inverters. Failure to observe this precaution could damage the product or cause overheating or fire.

 **Use appropriate cables**

When connecting cables to the input and output jacks, use only the cables provided or sold by Nikon for the purpose to maintain compliance with product regulations.

 **CD-ROMs**

CD-ROMs containing software or manuals should not be played back on audio CD equipment. Playing CD-ROMs on an audio CD player could cause hearing loss or damage the equipment.

 **Follow the directions of airline and hospital personnel**

Remove Eye-Fi cards, disable Wi-Fi, and select **Off** for **Location data** > **Record location data** before boarding an aircraft, and turn the product off during takeoff and landing or when so directed by airline or hospital staff. Radio waves emitted by the device could interfere with aircraft navigation or hospital medical equipment.

Notices

- No part of the manuals included with this product may be reproduced, transmitted, transcribed, stored in a retrieval system, or translated into any language in any form, by any means, without Nikon's prior written permission.
- Nikon reserves the right to change the appearance and specifications of the hardware and software described in these manuals at any time and without prior notice.
- Nikon will not be held liable for any damages resulting from the use of this product.
- While every effort has been made to ensure that the information in these manuals is accurate and complete, we would appreciate it were you to bring any errors or omissions to the attention of the Nikon representative in your area (address provided separately).

Notice for Customers in Canada

CAN ICES-3 B / NMB-3 B

Notices for Customers in Europe

CAUTION

RISK OF EXPLOSION IF BATTERY IS REPLACED BY AN INCORRECT TYPE. DISPOSE OF USED BATTERIES ACCORDING TO THE INSTRUCTIONS.

This symbol indicates that electrical and electronic equipment is to be collected separately.



The following apply only to users in European countries:

- This product is designated for separate collection at an appropriate collection point. Do not dispose of as household waste.
- Separate collection and recycling helps conserve natural resources and prevent negative consequences for human health and the environment that might result from incorrect disposal.
- For more information, contact the retailer or the local authorities in charge of waste management.

This symbol on the battery indicates that the battery is to be collected separately.



The following apply only to users in European countries:

- All batteries, whether marked with this symbol or not, are designated for separate collection at an appropriate collection point. Do not dispose of as household waste.
- For more information, contact the retailer or the local authorities in charge of waste management.

Notices for Customers in the U.S.A.

The Battery Charger

**IMPORTANT SAFETY INSTRUCTIONS—SAVE THESE INSTRUCTIONS
DANGER—TO REDUCE THE RISK OF FIRE OR ELECTRIC SHOCK, CAREFULLY
FOLLOW THESE INSTRUCTIONS**

For connection to a supply not in the U.S.A., use an attachment plug adapter of the proper configuration for the power outlet if needed. This power unit is intended to be correctly oriented in a vertical or floor mount position.

Federal Communications Commission (FCC) Radio Frequency Interference Statement

This equipment has been tested and found to comply with the limits for a Class B digital device, pursuant to Part 15 of the FCC rules. These limits are designed to provide reasonable protection against harmful interference in a residential installation. This equipment generates, uses, and can radiate radio frequency energy and, if not installed and used in accordance with the instructions, may cause harmful interference to radio communications. However, there is no guarantee that interference will not occur in a particular installation. If this equipment does cause harmful interference to radio or television reception, which can be determined by turning the equipment off and on, the user is encouraged to try to correct the interference by one or more of the following measures:

- Reorient or relocate the receiving antenna.
- Increase the separation between the equipment and receiver.
- Connect the equipment into an outlet on a circuit different from that to which the receiver is connected.
- Consult the dealer or an experienced radio/television technician for help.



Nikon
D5300

CAUTIONS

Modifications

The FCC requires the user to be notified that any changes or modifications made to this device that are not expressly approved by Nikon Corporation may void the user's authority to operate the equipment.

Interface Cables

Use the interface cables sold or provided by Nikon for your equipment. Using other interface cables may exceed the limits of Class B Part 15 of the FCC rules.

Nikon Inc., 1300 Walt Whitman Road,
Melville, New York 11747-3064, U.S.A.
Tel.: 631-547-4200

Notice Concerning Prohibition of Copying or Reproduction

Note that simply being in possession of material that has been digitally copied or reproduced by means of a scanner, digital camera, or other device may be punishable by law.

- **Items prohibited by law from being copied or reproduced**

Do not copy or reproduce paper money, coins, securities, government bonds, or local government bonds, even if such copies or reproductions are stamped "Sample."

The copying or reproduction of paper money, coins, or securities which are circulated in a foreign country is prohibited.

Unless the prior permission of the government has been obtained, the copying or reproduction of unused postage stamps or post cards issued by the government is prohibited.

The copying or reproduction of stamps issued by the government and of certified documents stipulated by law is prohibited.

- **Cautions on certain copies and reproductions**

The government has issued cautions on copies or reproductions of securities issued by private companies (shares, bills, checks, gift certificates, etc.), commuter passes, or coupon tickets, except when a minimum of necessary copies are to be provided for business use by a company. Also, do not copy or reproduce passports issued by the government, licenses issued by public agencies and private groups, ID cards, and tickets, such as passes and meal coupons.

- **Comply with copyright notices**

The copying or reproduction of copyrighted creative works such as books, music, paintings, woodcuts, prints, maps, drawings, movies, and photographs is governed by national and international copyright laws. Do not use this product for the purpose of making illegal copies or to infringe copyright laws.

Disposing of Data Storage Devices

Please note that deleting images or formatting memory cards or other data storage devices does not completely erase the original image data. Deleted files can sometimes be recovered from discarded storage devices using commercially available software, potentially resulting in the malicious use of personal image data. Ensuring the privacy of such data is the user's responsibility.

Before discarding a data storage device or transferring ownership to another person, select **Off** for **Location data > Record location data** (□ 74) in the setup menu and, erase all data using commercial deletion software, or format the device and then completely refill it with images containing no private information (for example, pictures of empty sky). Be sure to also replace any pictures selected for preset manual (□ 104). To delete track log data on a memory card, select **Location data > Log list** and delete all logs as described on page 78. Wi-Fi settings can be reset to default values by selecting **Wi-Fi > Network settings > Reset network settings** in the setup menu. Care should be taken to avoid injury when physically destroying data storage devices.

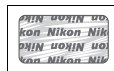
AVC Patent Portfolio License

THIS PRODUCT IS LICENSED UNDER THE AVC PATENT PORTFOLIO LICENSE FOR THE PERSONAL AND NON-COMMERCIAL USE OF A CONSUMER TO (i) ENCODE VIDEO IN COMPLIANCE WITH THE AVC STANDARD ("AVC VIDEO") AND/OR (ii) DECODE AVC VIDEO THAT WAS ENCODED BY A CONSUMER ENGAGED IN A PERSONAL AND NON-COMMERCIAL ACTIVITY AND/OR WAS OBTAINED FROM A VIDEO PROVIDER LICENSED TO PROVIDE AVC VIDEO. NO LICENSE IS GRANTED OR SHALL BE IMPLIED FOR ANY OTHER USE. ADDITIONAL INFORMATION MAY BE OBTAINED FROM MPEG LA, L.L.C. SEE <http://www.mpegla.com>

Use Only Nikon Brand Electronic Accessories

Nikon cameras are designed to the highest standards and include complex electronic circuitry. Only Nikon brand electronic accessories (including chargers, batteries, AC adapters, and flash accessories) certified by Nikon specifically for use with this Nikon digital camera are engineered and proven to operate within the operational and safety requirements of this electronic circuitry.

The use of non-Nikon electronic accessories could damage the camera and may void your Nikon warranty. The use of third-party rechargeable Li-ion batteries not bearing the Nikon holographic seal shown at right could interfere with normal operation of the camera or result in the batteries overheating, igniting, rupturing, or leaking.



For more information about Nikon brand accessories, contact a local authorized Nikon dealer.

Use Only Nikon Brand Accessories

Only Nikon brand accessories certified by Nikon specifically for use with your Nikon digital camera are engineered and proven to operate within its operational and safety requirements. THE USE OF NON-NIKON ACCESSORIES COULD DAMAGE YOUR CAMERA AND MAY VOID YOUR NIKON WARRANTY.

Before Taking Important Pictures

Before taking pictures on important occasions (such as at weddings or before taking the camera on a trip), take a test shot to ensure that the camera is functioning normally. Nikon will not be held liable for damages or lost profits that may result from product malfunction.

Life-Long Learning

As part of Nikon's "Life-Long Learning" commitment to ongoing product support and education, continually-updated information is available on-line at the following sites:

- **For users in the U.S.A.:** <http://www.nikonusa.com/>
- **For users in Europe and Africa:** <http://www.europe-nikon.com/support/>
- **For users in Asia, Oceania, and the Middle East:** <http://www.nikon-asia.com/>

Visit these sites to keep up-to-date with the latest product information, tips, answers to frequently-asked questions (FAQs), and general advice on digital imaging and photography. Additional information may be available from the Nikon representative in your area. See the following URL for contact information: <http://imaging.nikon.com/>

Location Data

Track logs: Location data will be recorded with pictures taken while **On** is selected for **Location data > Record location data** (☐ 74). In addition, if **Start** is selected for **Location data > Create log > Log location data** in the setup menu (☐ 76), the camera continues to log location data even while off. Radio waves produced by the device may affect medical equipment and aircraft navigation systems; in situations in which the use of satellite navigation devices is restricted or prohibited, such as in hospitals or aircraft, be sure to select **Off** for **Record location data** and turn the camera off.

Sharing location data: Note that addresses and other personal information may be inferred from the location data stored in track logs or embedded in images. Exercise caution when sharing images and track logs or when posting them to the Internet or other locations where they can be viewed by third parties. See “Disposing of Data Storage Devices” (☐ xiii) for information on erasing location data before disposing of the camera or memory cards.

Navigation: The position, altitude, and other location data reported by the device are approximations only and are not intended for surveying or navigation. Be sure to take appropriate maps or other navigational devices with you when using the product during such outdoor activities as mountain climbing or hiking.

Restrictions on use: The location data function may not perform as expected in some countries or regions, including (as of November, 2013) China and in the vicinity of the Chinese border. Some countries, including China, prohibit unauthorized use of satellite navigation and other location data devices; before travelling, check with your travel agent or the embassy or tourism board of the countries you will be visiting. Where use is prohibited, select **Off** for **Record location data**.

Wireless

This product, which contains encryption software developed in the United States, is controlled by the United States Export Administration Regulations and may not be exported or re-exported to any country to which the United States embargoes goods. The following countries are currently subject to embargo: Cuba, Iran, North Korea, Sudan, and Syria.

Notices for Customers in the U. S. A.

This device complies with Part 15 of the FCC Rules. Operation is subject to the following two conditions: (1) this device may not cause harmful interference, and (2) this device must accept any interference received, including interference that may cause undesired operation.

FCC WARNING

The FCC requires the user to be notified that any changes or modifications made to this device that are not expressly approved by Nikon Corporation may void the user's authority to operate the equipment.

FCC Radio Frequency Interference Statement

Note: This equipment has been tested and found to comply with the limits for a Class B digital device, pursuant to part 15 of the FCC Rules. These limits are designed to provide reasonable protection against harmful interference in a residential installation. This equipment generates, uses and can radiate radio frequency energy and, if not installed and used in accordance with the instructions, may cause harmful interference to radio communications. However, there is no guarantee that interference will not occur in a particular installation. If this equipment does cause harmful interference to radio or television reception, which can be determined by turning the equipment off and on, the user is encouraged to try to correct the interference by one or more of the following measures:

- Reorient or relocate the receiving antenna.
- Increase the separation between the equipment and receiver.
- Connect the equipment into an outlet on a circuit different from that to which the receiver is connected.
- Consult the dealer or an experienced radio/TV technician for help.

Co-location

This transmitter must not be co-located or operated in conjunction with any other antenna or transmitter.

Nikon Inc., 1300 Walt Whitman Road, Melville, New York 11747-3064, U.S.A.

Tel.: 631-547-4200

Notices for Customers in Canada

This Class B digital apparatus complies with Canadian ICES-003.

This device complies with Industry Canada licence-exempt RSS standard(s). Operation is subject to the following two conditions: (1) this device may not cause interference, and (2) this device must accept any interference, including interference that may cause undesired operation of the device.

FCC/IC RF Exposure Statement

The available scientific evidence does not show that any health problems are associated with using low power wireless devices. There is no proof, however, that these low power wireless devices are absolutely safe. Low power Wireless devices emit low levels of radio frequency energy (RF) in the microwave range while being used. Whereas high levels of RF can produce health effects (by heating tissue), exposure of low-level RF that does not produce heating effects causes no known adverse health effects. Many studies of low-level RF exposures have not found any biological effects. Some studies have suggested that some biological effects might occur, but such findings have not been confirmed by additional research. The D5300, which is equipped with a LBWA1U5YR1 (FCC ID: VPYLBYSR650/IC ID: 772C-LBYSR650) wireless LAN module, has been tested and found to comply with FCC/IC radiation exposure limits set forth for an uncontrolled environment and meets the FCC radio frequency (RF) Exposure Guidelines in Supplement C to OET65 and RSS-102 of the IC radio frequency (RF) Exposure rules. Please refer to the SAR test report that was uploaded to FCC website.

Notices for Customers in Europe

Hereby, Nikon, declares that the D5300 is in compliance with the essential requirements and other relevant provisions of Directive 1999/5/EC. The declaration of conformity may be consulted at

http://imaging.nikon.com/support/pdf/DoC_D5300.pdf



Notice for Customers in Singapore

Trade Name: Nikon Model: D5300
--

This device complies with radio-frequency regulations. The content of certification labels not affixed to the device is given below.

Complies with IMDA Standards DA104328

Security

Although one of the benefits of this product is that it allows others to freely connect for the wireless exchange of data anywhere within its range, the following may occur if security is not enabled:

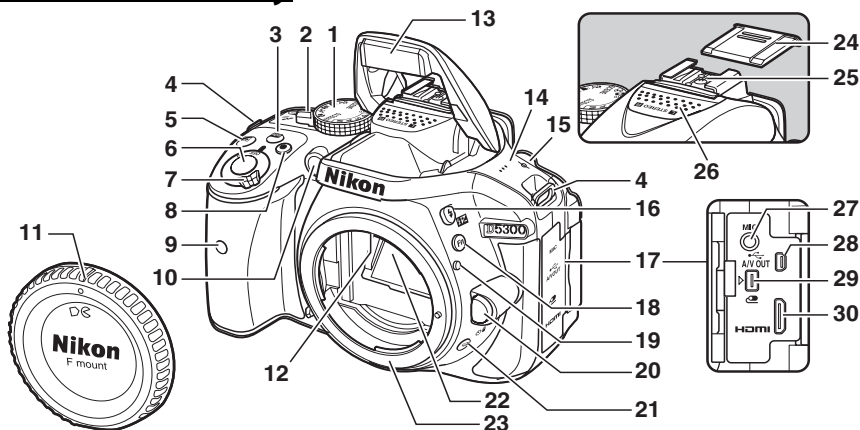
- Data theft: Malicious third-parties may intercept wireless transmissions to steal user IDs, passwords, and other personal information.
- Unauthorized access: Unauthorized users may gain access to the network and alter data or perform other malicious actions. Note that due the design of wireless networks, specialized attacks may allow unauthorized access even when security is enabled.

Introduction

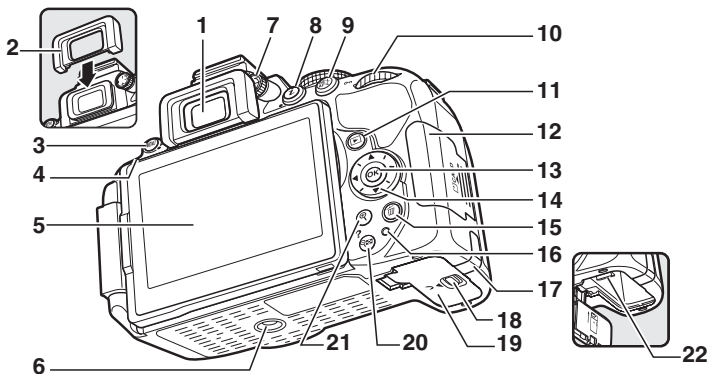
Getting to Know the Camera

Take a few moments to familiarize yourself with camera controls and displays. You may find it helpful to bookmark this section and refer to it as you read through the rest of the manual.

The Camera Body



1 Mode dial..... 3	12 CPU contacts	23 Lens mount 13, 58
2 Live view switch Live view24, 118 Movie27, 126	13 Built-in flash..... 62	24 Accessory shoe cover
3 (information) button... 6, 123	14 Speaker..... 2	25 Accessory shoe (for optional flash units)..... 232
4 Eyelets for camera strap..... 11	15 Focal plane mark (∞)..... 58	26 Stereo microphone..... 128
5 button Exposure compensation...92 Adjusting aperture87 Flash compensation.....93	16 button Flash mode 62, 64 Flash compensation 93	27 Connector for external microphone..... 129
6 Shutter-release button.....21	17 Connector cover	28 USB and A/V connector Connecting to a computer..... 153 Connecting to a printer 156 Connecting to a TV..... 164
7 Power switch.....2	18 Fn button Using the Fn button 193	29 Accessory terminal 237
8 Movie-record button ...28, 126	19 Mounting mark..... 13	30 HDMI mini-pin connector 165
9 Infrared receiver for ML-L3 remote control (front)..... 70	20 Lens release button 18	
10 AF-assist illuminator52, 185 Self-timer lamp49 Red-eye reduction lamp63, 65	21 button 45 Continuous shooting46 Self-timer49 Remote control..... 70	
11 Body cap..... 65	22 Mirror.....243	



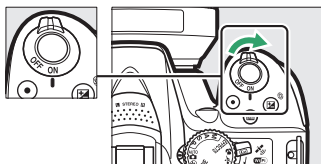
<p>1 Viewfinder eyepiece.. 4, 16, 50</p> <p>2 Rubber eyecup 50</p> <p>3 MENU button Menus8, 175 Restoring default settings 72</p> <p>4 Infrared receiver for ML-L3 remote control (rear).....70</p> <p>5 Monitor Viewing settings.....6 Live view 24, 118 Full-frame playback 22, 135</p> <p>6 Tripod socket</p> <p>7 Diopter adjustment control 16</p>	<p>8 z button Changing settings in the information display 7 Rating pictures, retouching photos, editing movies, and selecting pictures for upload to a smart device.....135 Restoring default settings 72</p> <p>9 AE-L/AF-ON button Using the AE-L/AF-ON button56, 194 Protecting photographs from deletion143</p> <p>10 Command dial</p> <p>11 ▶ button Playback.....22, 135</p> <p>12 Memory card slot cover..... 12, 17</p> <p>13 OK (OK) button 9</p>	<p>14 Multi selector9</p> <p>15 ⏏ button Deleting pictures during playback..... 22, 146</p> <p>16 Memory card access lamp 21, 118</p> <p>17 Power connector cover for optional power connector239</p> <p>18 Battery-chamber cover latch12, 17</p> <p>19 Battery-chamber cover 12, 17</p> <p>20 Q button Thumbnails..... 140 Playback zoom out 142 Help8</p> <p>21 Q button Playback zoom in 142</p> <p>22 Battery latch12, 17</p>
--	--	---

✓ The Speaker

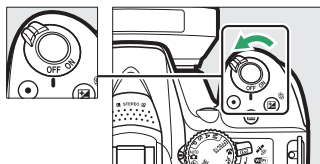
Do not place the speaker in close proximity to magnetic devices. Failure to observe this precaution could affect the data recorded on the magnetic devices.

✏ The Power Switch

Rotate the power switch as shown to turn the camera on.



Rotate the power switch as shown to turn the camera off.



The Mode Dial

The camera offers a choice of the following shooting modes:










P, S, A, and M Modes

Select these modes for full control over camera settings.

- **P**—Programmed auto (□ 84)
- **S**—Shutter-priority auto (□ 85)
- **A**—Aperture-priority auto (□ 86)
- **M**—Manual (□ 87)



Special Effects Modes

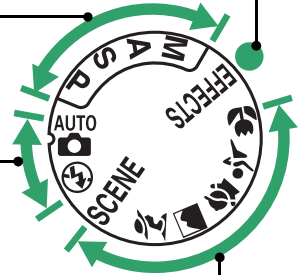
Use special effects during shooting.

-  **Night vision** (□ 37)
-  **Color sketch** (□ 38, 41)
-  **Toy camera effect** (□ 38, 42)
-  **Miniature effect** (□ 38, 42)
-  **Selective color** (□ 39, 43)
-  **Silhouette** (□ 39)
-  **High key** (□ 39)
-  **Low key** (□ 40)
-  **HDR painting** (□ 40)

Auto Modes

Select these modes for simple, point-and-shoot photography.

-  **Auto** (□ 19)
-  **Auto (flash off)** (□ 19)

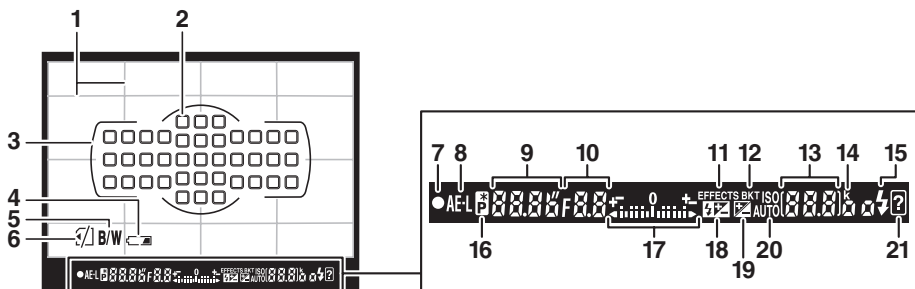
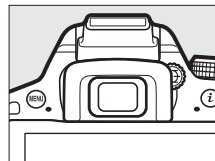


Scene Modes

The camera automatically optimizes settings to suit the scene selected with the mode dial. Match your selection to the scene being photographed.

-  **Portrait** (□ 31)
-  **Landscape** (□ 31)
-  **Child** (□ 31)
-  **Sports** (□ 32)
-  **Close up** (□ 32)
- **SCENE Other scenes** (□ 33)

The Viewfinder



<p>1 Framing grid (displayed when On is selected for Custom Setting d2) 188</p> <p>2 Focus points 55</p> <p>3 AF area brackets 16, 20</p> <p>4 Low battery warning 17</p> <p>5 Monochrome indicator (displayed in mode or when the Monochrome Picture Control or a Picture Control based on Monochrome is selected) 37, 111</p> <p>6 “No memory card” indicator 12</p> <p>7 Focus indicator 21, 57</p> <p>8 Autoexposure (AE) lock indicator 91</p> <p>9 Shutter speed 83</p>	<p>10 Aperture (f-number) 83</p> <p>11 Special effects mode indicator 37</p> <p>12 Bracketing indicator 108</p> <p>13 Number of exposures remaining 15</p> <p>Number of shots remaining before memory buffer fills 47</p> <p>White balance recording indicator 104</p> <p>Exposure compensation value 92</p> <p>Flash compensation value 93</p> <p>ISO sensitivity 67, 188</p> <p>Capture mode indicator</p> <p>14 “k” (appears when memory remains for over 1000 exposures) 15</p>	<p>15 Flash-ready indicator 23</p> <p>16 Flexible program indicator 84</p> <p>17 Exposure indicator 87</p> <p>Exposure compensation display 92</p> <p>Electronic rangefinder 185</p> <p>18 Flash compensation indicator 93</p> <p>19 Exposure compensation indicator 92</p> <p>20 Auto ISO sensitivity indicator 180</p> <p>21 Warning indicator 256</p>
--	--	---

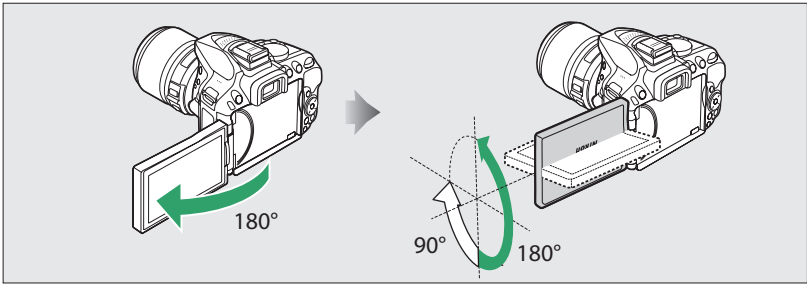
Note: Display shown with all indicators lit for illustrative purposes.

The Viewfinder

The response time and brightness of the viewfinder display may vary with temperature.

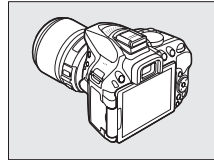
The Monitor

The monitor can be angled and rotated as shown below.



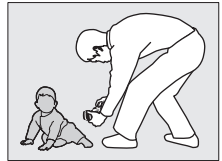
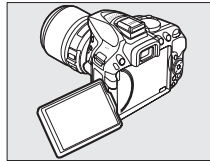
Normal use

Fold the monitor against the camera face out. This position is recommended for normal photography.



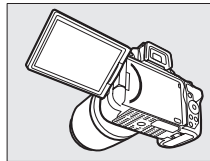
Low-angle shots

Frame live view shots with the camera close to the ground.



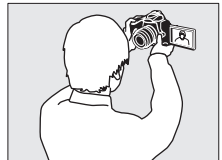
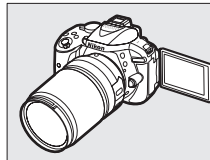
High-angle shots

Frame live view shots while holding the camera over your head.



Self-portraits

Use for self-portraits in live view. The monitor shows a mirror image of what will appear in the final picture.

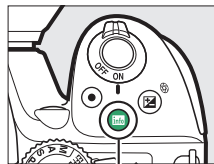


✔ Using the Monitor

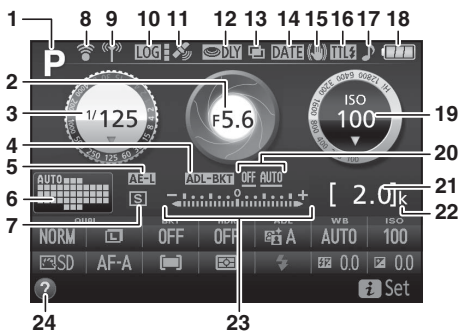
Rotate the monitor gently within the limits shown. *Do not use force.* Failure to observe these precautions could damage the connection between the monitor and the camera body. To protect the monitor when the camera is not in use, fold it back face down against the camera body.

The Information Display

Viewing settings: To view the information display, press the **info** button.



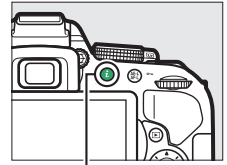
info button



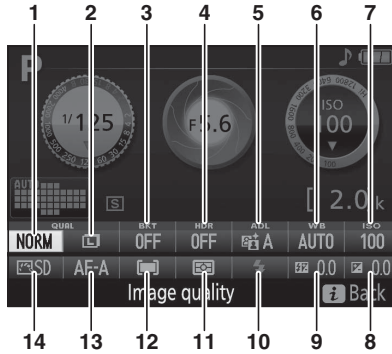
<p>1 Shooting mode AUTO auto/ auto (flash off)..... 19 Scene modes..... 30 Special effects mode..... 37 P, S, A, and M modes..... 82</p>	<p>11 Satellite signal indicator 75</p>	<p>21 Number of exposures remaining 15 White balance recording indicator 104 Capture mode indicator</p>
<p>2 Aperture (f-number) 83 Aperture display..... 83</p>	<p>12 Exposure delay mode 189</p>	<p>22 “k” (appears when memory remains for over 1000 exposures) 15</p>
<p>3 Shutter speed 83 Shutter-speed display..... 83</p>	<p>13 Multiple exposure indicator 100</p>	<p>23 Exposure indicator 87 Exposure compensation indicator 92 Bracketing progress indicator 110</p>
<p>4 Bracketing indicator 108</p>	<p>14 Print date indicator 190</p>	<p>24 Help icon 256</p>
<p>5 Autoexposure (AE) lock indicator..... 91</p>	<p>15 Vibration reduction indicator 18, 181</p>	
<p>6 Auto-area AF indicator 53 3D-tracking indicator..... 53 Focus point 55</p>	<p>16 Flash control indicator..... 192 Flash compensation indicator for optional flash units... 235</p>	
<p>7 Release mode 45</p>	<p>17 “Beep” indicator 187</p>	
<p>8 Eye-Fi connection indicator 204</p>	<p>18 Battery indicator 17</p>	
<p>9 Wi-Fi connection indicator..... 172</p>	<p>19 ISO sensitivity 67 ISO sensitivity display..... 67, 181 Auto ISO sensitivity indicator 180</p>	
<p>10 Track log indicator 77</p>	<p>20 ADL bracketing amount 109</p>	

Note: Display shown with all indicators lit for illustrative purposes.

Changing settings: To change the settings at the bottom of the display, press the **i** button, then highlight items using the multi-selector and press **OK** to view options for the highlighted item.



i button



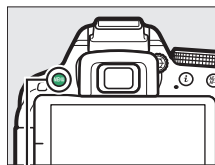
1 Image quality.....59	6 White balance 101	12 AF-area mode53, 120
2 Image size.....61	7 ISO sensitivity..... 67	13 Focus mode.....51, 119
3 Auto bracketing 109	8 Exposure compensation..... 92	14 Picture Control..... 111
4 HDR (High Dynamic Range).....96	9 Flash compensation 93	
5 Active D-Lighting.....94	10 Flash mode 63, 65	
	11 Metering..... 90	

Turning the Monitor Off

To clear shooting information from the monitor, press the **Info** button or press the shutter-release button halfway. The monitor will turn off automatically if no operations are performed for about 8 seconds (for information on choosing how long the monitor stays on, see **Auto off timers** on page 186).

Camera Menus: An Overview

Most shooting, playback, and setup options can be accessed from the camera menus. To view the menus, press the **MENU** button.

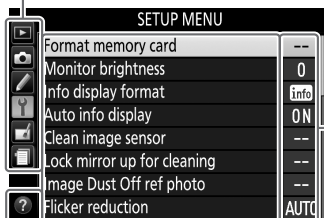


MENU button

Tabs

Choose from the following menus:

- : **Playback** (📖 175)
- : **Shooting** (📖 177)
- : **Custom Settings** (📖 182)
- : **Setup** (📖 195)
- : **Retouch** (📖 205)
- : **Recent settings** or **My Menu** (defaults to **Recent settings**; 📖 222)



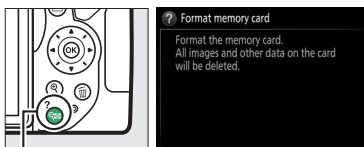
Current settings are shown by icons.

Menu options

Options in current menu.



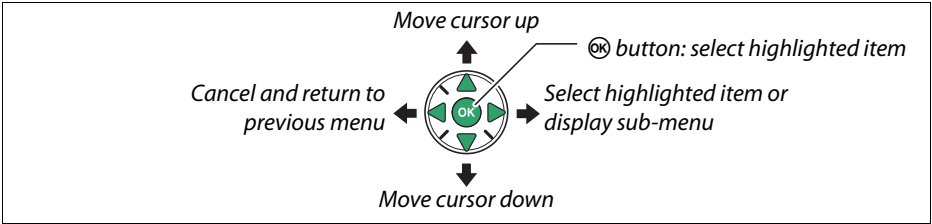
A description of the currently selected option or menu can be displayed by pressing the (?). Press or to scroll through the display. Press (?) again to return to the menus.



(?) button

■ Using Camera Menus

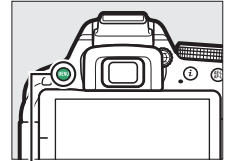
The multi selector and **OK** button are used to navigate the camera menus.



Follow the steps below to navigate the menus.

1 Display the menus.

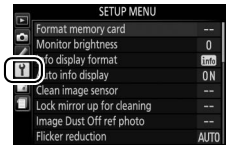
Press the **MENU** button to display the menus.



MENU button

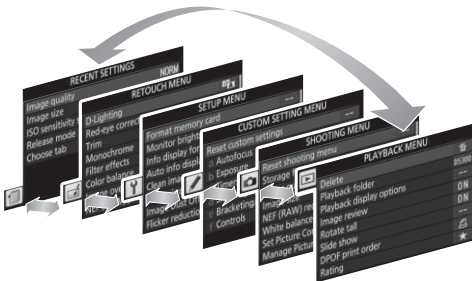
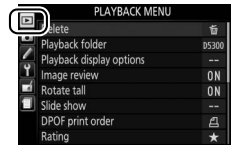
2 Highlight the icon for the current menu.

Press **◀** to highlight the icon for the current menu.



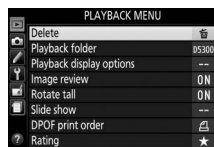
3 Select a menu.

Press **▲** or **▼** to select the desired menu.



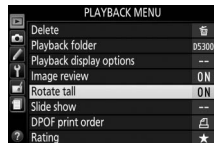
4 Position the cursor in the selected menu.

Press **▶** to position the cursor in the selected menu.



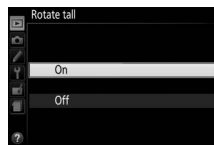
5 Highlight a menu item.

Press **▲** or **▼** to highlight a menu item.



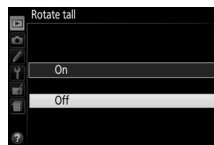
6 Display options.

Press **▶** to display options for the selected menu item.



7 Highlight an option.

Press **▲** or **▼** to highlight an option.



8 Select the highlighted item.

Press **OK** to select the highlighted item. To exit without making a selection, press the **MENU** button.



Note the following:

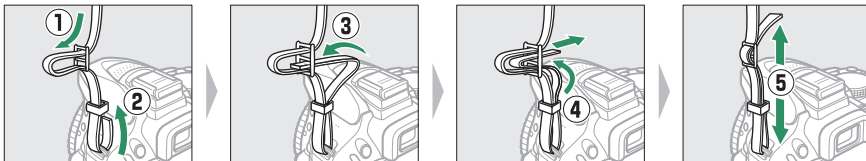
- Menu items that are displayed in gray are not currently available.
- While pressing **▶** generally has the same effect as pressing **OK**, there are some cases in which selection can only be made by pressing **OK**.
- To exit the menus and return to shooting mode, press the shutter-release button halfway (□ 21).

First Steps

Always turn the camera off before inserting or removing batteries or memory cards.

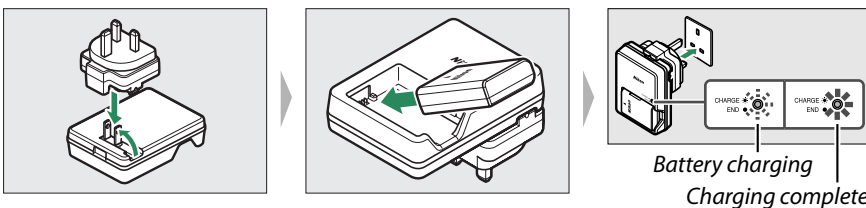
1 Attach the strap.

Attach the strap as shown. Repeat for the second eyelet.



2 Charge the battery.

If a plug adapter is supplied, raise the wall plug and connect the plug adapter as shown below at left, making sure the plug is fully inserted. Insert the battery and plug the charger in. An exhausted battery will fully charge in about an hour and 50 minutes.

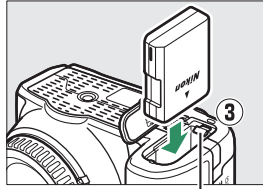
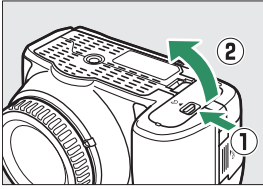


✓ During Charging

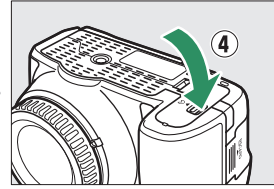
Do not move the charger or touch the battery during charging. Failure to observe this precaution could in very rare instances result in the charger showing that charging is complete when the battery is only partially charged. Remove and reinsert the battery to begin charging again.

3 Insert the battery and memory card.

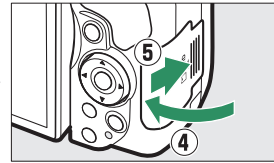
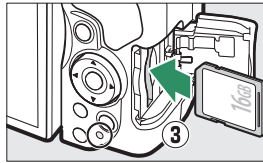
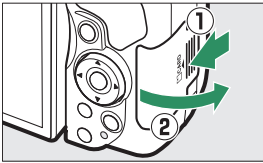
Insert the battery in the orientation shown, using the battery to keep the orange battery latch pressed to one side. The latch locks the battery in place when the battery is fully inserted.



Battery latch

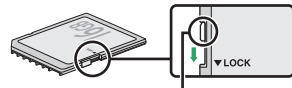


Slide the memory card in until it clicks into place.



The Write Protect Switch

SD memory cards are equipped with a write protect switch to prevent accidental loss of data. When this switch is in the “lock” position, the memory card can not be formatted and photos can not be deleted or recorded (a beep will sound if you attempt to release the shutter). To unlock the memory card, slide the switch to the “write” position.



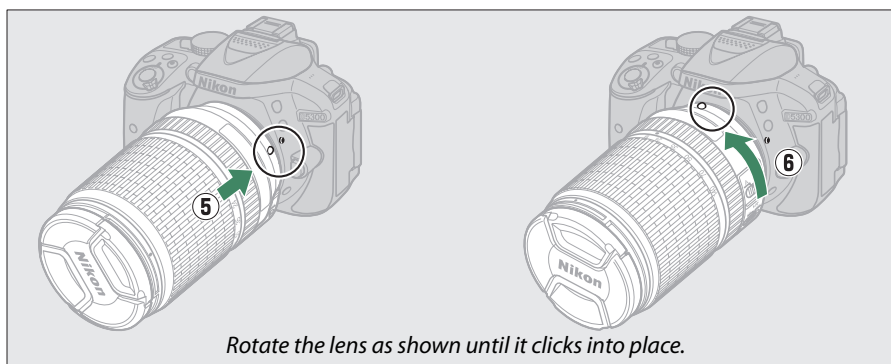
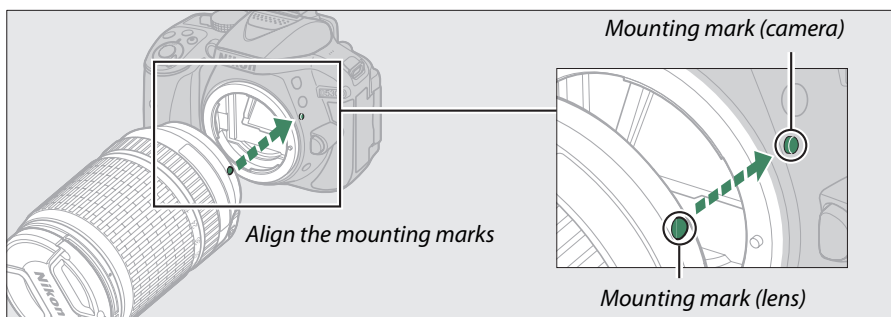
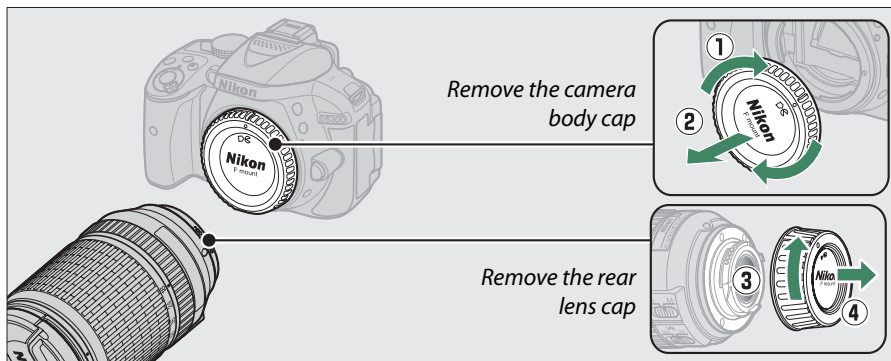
Write-protect switch

Memory Cards

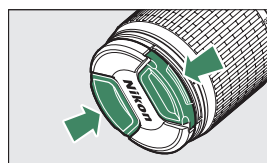
- Memory cards may be hot after use. Observe due caution when removing memory cards from the camera.
- Turn the power off before inserting or removing memory cards. Do not remove memory cards from the camera, turn the camera off, or remove or disconnect the power source during formatting or while data are being recorded, deleted, or copied to a computer. Failure to observe these precautions could result in loss of data or in damage to the camera or card.
- Do not touch the card terminals with your fingers or metal objects.
- Do not bend, drop, or subject to strong physical shocks.
- Do not apply force to the card casing. Failure to observe this precaution could damage the card.
- Do not expose to water, heat, high levels of humidity, or direct sunlight.
- Do not format memory cards in a computer.

4 Attach a lens.

Be careful to prevent dust from entering the camera when the lens or body cap is removed.

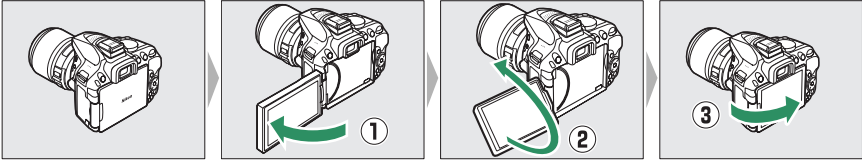


Be sure to remove the lens cap before taking pictures.



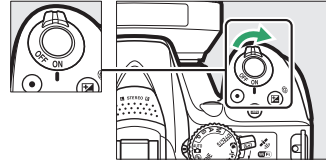
5 Open the monitor.

Open the monitor as shown. *Do not use force.*



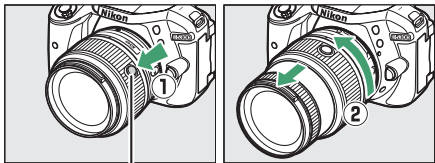
6 Turn the camera on.

A language-selection dialog will be displayed.



Lenses with Retractable Lens Barrel Buttons

Before using the camera, unlock and extend the zoom ring. Keeping the retractable lens barrel button pressed (1), rotate the zoom ring as shown (2).



Retractable lens barrel button

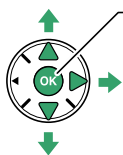
Pictures can not be taken when the lens is retracted; if an error message is displayed as a result of the camera having been turned on with the lens retracted, rotate the zoom ring until the message is no longer displayed.



7 Choose a language and set the camera clock.

Use the multi selector and **OK** button to select a language and set the camera clock.


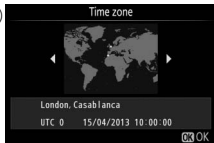
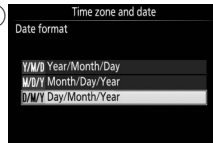
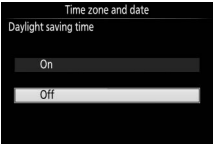
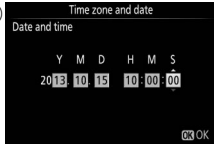
Move cursor up



OK button: select highlighted item

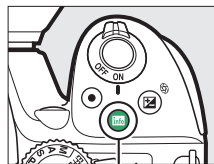
Select highlighted item or display sub-menu

Move cursor down

- 1** 
Select language
- 2** 
Select time zone
- 3** 
Select date format
- 4** 
Select daylight saving time option
- 5** 
Set time and date (note that the camera uses a 24-hour clock)

8 Check the battery level and number of exposures remaining.

Press the **info** button and check the battery level and number of exposures remaining. In the case of exposures remaining, values over 1000 are shown in thousands, indicated by the letter “k”.



info button

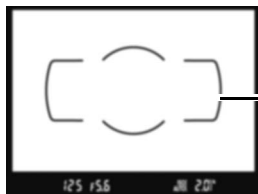
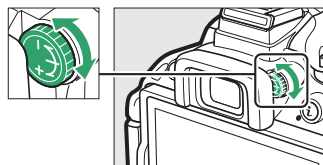
Battery level (17)



Number of exposures remaining

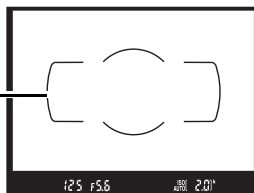
9 Focus the viewfinder.

After removing the lens cap, rotate the diopter adjustment control until the AF area brackets are in sharp focus. When operating the control with your eye to the viewfinder, be careful not to put your fingers or fingernails in your eye.



Viewfinder not in focus

AF area brackets



Viewfinder in focus

Charging the Battery







Read and follow the warnings and cautions on pages viii–x and 245–247 of this manual. Charge the battery indoors at ambient temperatures of 5 °C–35 °C (41 °F–95 °F). Do not use the battery at ambient temperatures below 0 °C/32 °F or above 40 °C/104 °F; failure to observe this precaution could damage the battery or impair its performance. Capacity may be reduced and charging times may increase at battery temperatures from 0 °C/32 °F to 15 °C/59 °F and from 45 °C/113 °F to 60 °C/140 °F. The battery will not charge if its temperature is below 0 °C (32 °F) or above 60 °C (140 °F). If the **CHARGE** lamp flashes quickly (about eight times a second) during charging, confirm that the temperature is in the correct range and then unplug the charger and remove and reinsert the battery. If the problem persists, cease use immediately and take battery and charger to your retailer or a Nikon-authorized service representative.

Use the charger with compatible batteries only. Unplug when not in use.

Battery Level

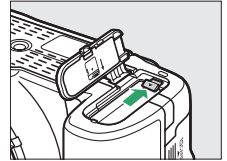
Battery level is shown in the information display (if the battery is low, a warning will also be displayed in the viewfinder). If the information display does not appear when the **info** button is pressed, the battery is exhausted and needs to be recharged.



Information display	Viewfinder	Description
	—	Battery fully charged.
	—	Battery partially discharged.
		Low battery. Ready fully-charged spare battery or prepare to charge battery.
 (flashes)	 (flashes)	Battery exhausted. Charge battery.

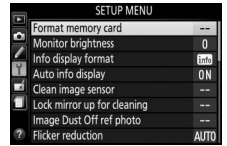
Removing the Battery

To remove the battery, turn the camera off and open the battery-chamber cover. Press the battery latch in the direction shown by the arrow to release the battery and then remove the battery by hand.



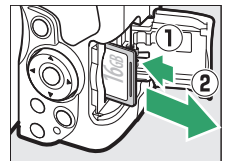
Formatting Memory Cards

If this is the first time the memory card will be used in the camera or if the card has been formatted in another device, select **Format memory card** in the setup menu and follow the on-screen instructions to format the card (□ 196). *Note that this permanently deletes any data the card may contain.* Be sure to copy any photographs and other data you wish to keep to a computer before proceeding.



Removing Memory Cards

After confirming that the memory card access lamp is off, turn the camera off, open the memory card slot cover, and press the card in to eject it (①). The card can then be removed by hand (②).



A-M, M/A-M, and A/M-M Switches

When using autofocus with a lens equipped with an **A-M** mode switch, slide the switch to **A** (if the lens has an **M/A-M** or **A/M-M** switch, select **M/A** or **A/M**). For information on other lenses that can be used with this camera, see page 226.



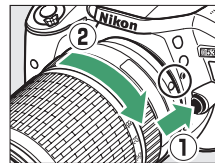
Vibration Reduction (VR)

Vibration reduction can be enabled by selecting **On** for **Optical VR** in the shooting menu (☐ 181), if the lens supports this option, or by sliding the lens vibration reduction switch to **ON**, if the lens is equipped with a vibration reduction switch. A vibration reduction indicator appears in the information display when vibration reduction is on.



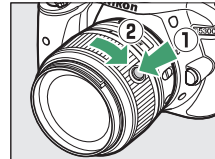
Detaching the Lens

Be sure the camera is off when removing or exchanging lenses. To remove the lens, press and hold the lens release button (1) while turning the lens clockwise (2). After removing the lens, replace the lens caps and camera body cap.



Retracting Lenses with Retractable Lens Barrel Buttons

To retract the lens when the camera is not in use, hold the retractable lens barrel button (1) and rotate the zoom ring to the “L” (lock) position as shown (2). Retract the lens before removing it from the camera, and be careful not to press the retractable lens barrel button when attaching or removing the lens.



The Camera Clock



The camera clock is less accurate than most watches and household clocks. Check the clock regularly against more accurate time pieces and reset as necessary.

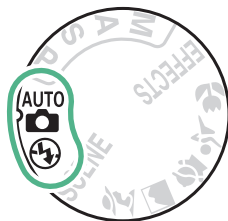
The Clock Battery




The camera clock is powered by an independent, rechargeable power source, which is charged as necessary when the main battery is installed. Three days of charging will power the clock for about a month. If a message warning that the clock is not set is displayed when the camera is turned on, the clock battery is exhausted and the clock has been reset. Set the clock to the correct time and date.

“Point-and-Shoot” Modes

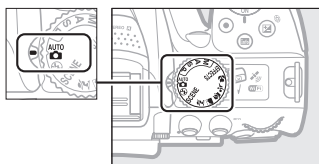
(and)

This section describes how to shoot photographs and movies in  and  modes, automatic “point-and-shoot” modes in which the majority of settings are controlled by the camera in response to shooting conditions.






Before proceeding, turn the camera on and rotate the mode dial to  or  (the only difference between the two is that the flash will not fire in  mode).

Mode dial






Viewfinder photography






- Taking photographs  20
- Viewing photographs  22
- Deleting photographs  22

Live view



- Taking photographs  24
- Viewing photographs  26
- Deleting photographs  26



- Shooting movies  27
- Viewing movies  28
- Deleting movies  29

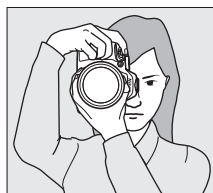
Framing Photos in the Viewfinder

1 Ready the camera.

When framing photographs in the viewfinder, hold the handgrip in your right hand and cradle the camera body or lens with your left.

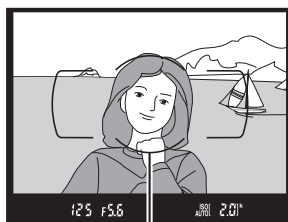


When framing photographs in portrait (tall) orientation, hold the camera as shown at right.



2 Frame the photograph.

Frame a photograph in the viewfinder with the main subject in the AF area brackets.



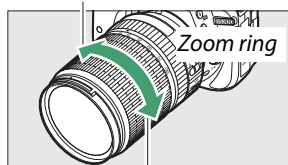
AF area brackets

Using a Zoom Lens

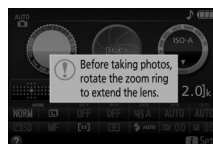
Before focusing, rotate the zoom ring to adjust the focal length and frame the photograph. Use the zoom ring to zoom in on the subject so that it fills a larger area of the frame, or zoom out to increase the area visible in the final photograph (select longer focal lengths on the lens focal length scale to zoom in, shorter focal lengths to zoom out).

If the lens is equipped with a retractable lens barrel button (14), press and hold the button while rotating the zoom ring until the lens is released and the message shown at right is no longer displayed, and then adjust zoom using the zoom ring.

Zoom in



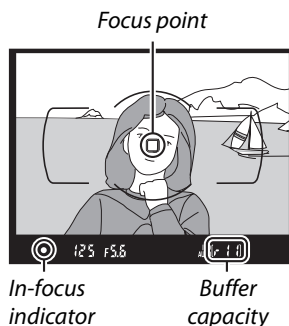
Zoom out



3 Press the shutter-release button halfway.

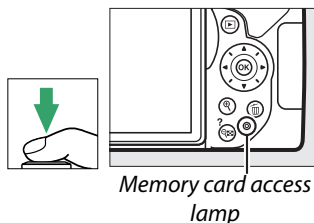
Press the shutter-release button halfway to focus (if the subject is poorly lit, the flash may pop up and the AF-assist illuminator may light). When the focus operation is complete, a beep will sound (a beep may not sound if the subject is moving) and the active focus point and in-focus indicator (●) will appear in the viewfinder.

In-focus indicator	Description
●	Subject in focus.
● (flashes)	Camera unable to focus using autofocus. See page 52.



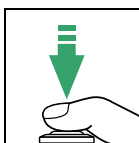
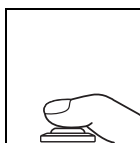
4 Shoot.

Smoothly press the shutter-release button the rest of the way down to take the photograph. The memory card access lamp will light and the photograph will be displayed in the monitor for a few seconds. *Do not eject the memory card or remove or disconnect the power source until the lamp has gone out and recording is complete.*

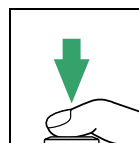


The Shutter-Release Button

The camera has a two-stage shutter-release button. The camera focuses when the shutter-release button is pressed halfway. To take the photograph, press the shutter-release button the rest of the way down.




Focus: press halfway





Shoot: press all the way down

Pressing the shutter-release button halfway also ends playback and readies the camera for immediate use.

Viewing Photographs

Pressing  displays a picture in the monitor.




Press  or  to view additional pictures.



Deleting Unwanted Pictures

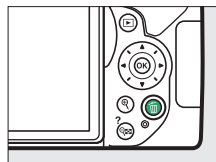
Display the photograph you wish to delete.




Press ; a confirmation dialog will be displayed.

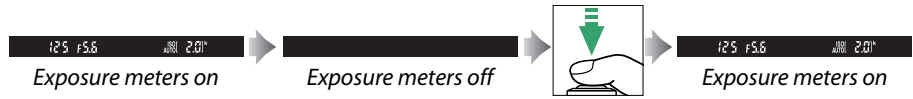


Press the  button again to delete the picture.






The Standby Timer

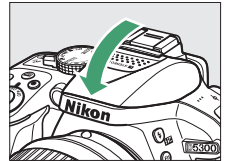
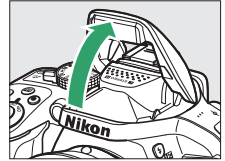
The viewfinder and information display will turn off if no operations are performed for about eight seconds, reducing the drain on the battery. Press the shutter-release button halfway to reactivate the display. The length of time before the standby timer expires automatically can be selected using Custom Setting c2 (**Auto off timers**;  186).



The Built-in Flash

If additional lighting is required for correct exposure in  mode, the built-in flash will pop up automatically when the shutter-release button is pressed halfway ( 62). If the flash is raised, photographs can only be taken when the flash-ready indicator () is displayed. If the flash-ready indicator is not displayed, the flash is charging; remove your finger briefly from the shutter-release button and try again.

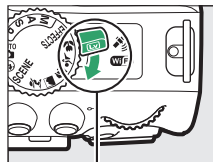
When the flash is not in use, return it to its closed position by pressing it gently downward till the latch clicks into place.



Framing Photos in the Monitor

1 Rotate the live view switch.

The view through the lens will be displayed in the camera monitor (live view).



Live view switch

2 Ready the camera.

Hold the handgrip in your right hand and cradle the camera body or lens with your left.



When framing photographs in portrait (tall) orientation, hold the camera as shown at right.



3 Focus.

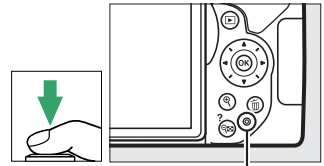
Press the shutter-release button halfway. The focus point will flash green while the camera focuses. If the camera is able to focus, the focus point will be displayed in green; if the camera is unable to focus, the focus point will flash red.



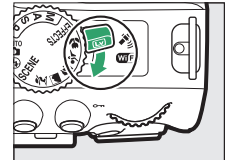
Focus point

4 Take the picture.



Press the shutter-release button the rest of the way down. The monitor turns off and the memory card access lamp lights during recording. *Do not eject the memory card or remove or disconnect the power source until the lamp has gone out and recording is complete.* When recording is complete, the photograph will be displayed in the monitor for a few seconds. Rotate the live view switch to exit live view.











Memory card access lamp



Automatic Scene Selection (Scene Auto Selector)

If live view is selected in  or  mode, the camera will automatically analyze the subject and select the appropriate shooting mode when autofocus is enabled. The selected mode is shown in the monitor.




	Portrait	Human portrait subjects
	Landscape	Landscapes and cityscapes
	Close up	Subjects close to the camera
	Night portrait	Portrait subjects framed against a dark background
	Auto	Subjects suited to  or  mode or that do not fall into the categories listed above
	Auto (flash off)	listed above



Live View

For more information on taking photographs in live view, see page 118.

Viewing Photographs

Pressing  displays a picture in the monitor.




Press  or  to view additional pictures.




Deleting Unwanted Pictures

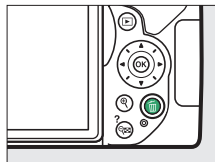
Display the photograph you wish to delete.



Press ; a confirmation dialog will be displayed.



Press the  button again to delete the picture.

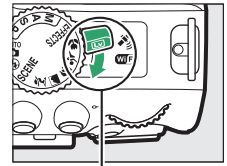


Recording Movies

Movies can be recorded in live view mode.

1 Rotate the live view switch.

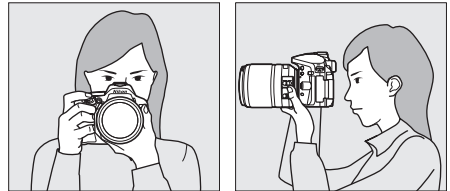
The view through the lens is displayed in the monitor.



Live view switch

2 Ready the camera.

Hold the handgrip in your right hand and cradle the camera body or lens with your left.



3 Focus.

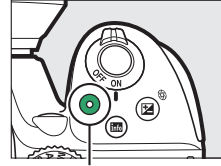
Press the shutter-release button halfway to focus.



Focus point

4 Start recording.

Press the movie-record button to start recording. A recording indicator and the time available are displayed in the monitor.



Movie-record button

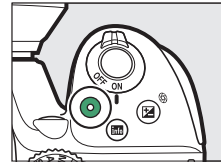
Recording indicator








Time remaining

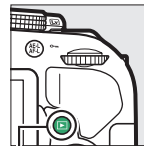
5 End recording.

Press the movie-record button again to end recording. Rotate the live view switch to exit live view.



Viewing Movies

Press  to start playback and then scroll through pictures until a movie (indicated by a  icon) is displayed. Press  to start playback and press  or  to end playback. For more information, see page 130.




 button




Recording Movies


See page 126 for more information on recording movies.

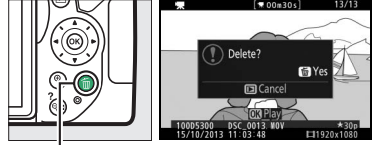
Deleting Unwanted Movies

Display the movie you wish to delete (movies are indicated by  icons).




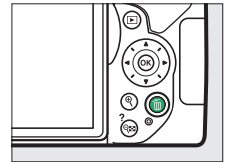
 button

Press ; a confirmation dialog will be displayed.



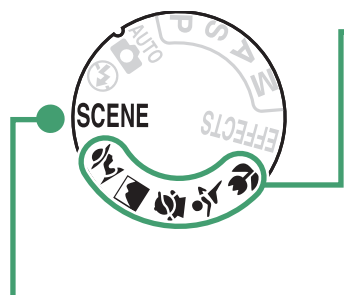
 button

Press the  button again to delete the movie.



Matching Settings to the Subject or Situation (Scene Mode)

The camera offers a choice of “scene” modes. Choosing a scene mode automatically optimizes settings to suit the selected scene, making creative photography as simple as selecting a mode, framing a picture, and shooting as described on page 19.




The scenes listed below can be selected with the mode dial.

 Portrait

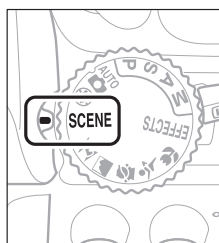
 Landscape

 Child

 Sports

 Close up


The following scenes can be selected by rotating the mode dial to **SCENE** and rotating the command dial until the desired scene appears in the monitor.




+




 Night Portrait

 Night Landscape

 Party/Indoor

 Beach/Snow


 Sunset

 Dusk/Dawn

 Pet Portrait

 Candlelight

 Blossom

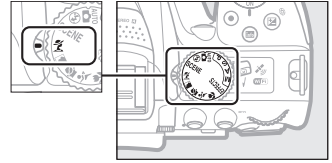
 Autumn Colors

 Food

The Mode Dial

The following scenes can be selected with the mode dial:

Mode dial



Portrait



Use for portraits with soft, natural-looking skin tones. If the subject is far from the background or a telephoto lens is used, background details will be softened to lend the composition a sense of depth.

Landscape



Use for vivid landscape shots in daylight.

Note

The built-in flash and AF-assist illuminator turn off.

Child



Use for snapshots of children. Clothing and background details are vividly rendered, while skin tones remain soft and natural.

Sports



Fast shutter speeds freeze motion for dynamic sports shots in which the main subject stands out clearly.

Note

The built-in flash and AF-assist illuminator turn off.

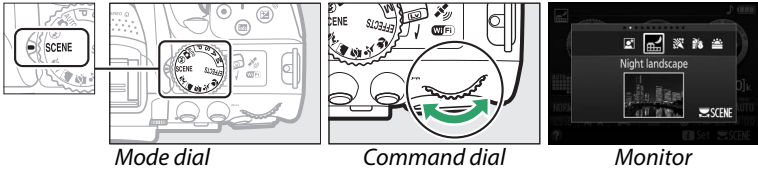
Close up



Use for close-up shots of flowers, insects, and other small objects (a macro lens can be used to focus at very close ranges).

Other Scenes

The following scenes can be selected by rotating the mode dial to **SCENE** and rotating the command dial until the desired scene appears in the monitor.



Night Portrait



Use for a natural balance between the main subject and the background in portraits taken under low light.

Night Landscape



Reduce noise and unnatural colors when photographing night landscapes, including street lighting and neon signs.

 **Note**

The built-in flash and AF-assist illuminator turn off.

Party/Indoor



Capture the effects of indoor background lighting. Use for parties and other indoor scenes.

Beach/Snow



Capture the brightness of sunlit expanses of water, snow, or sand.

Note

The built-in flash and AF-assist illuminator turn off.

Sunset



Preserves the deep hues seen in sunsets and sunrises.

Note

The built-in flash and AF-assist illuminator turn off.

Dusk/Dawn



Preserves the colors seen in the weak natural light before dawn or after sunset.

Note

The built-in flash and AF-assist illuminator turn off.

Pet Portrait



Use for portraits of active pets.

Note

The AF-assist illuminator turns off.

Candlelight



For photographs taken by candlelight.

Note

The built-in flash turns off.

Blossom



Use for fields of flowers, orchards in bloom, and other landscapes featuring expanses of blossoms.

Note

The built-in flash turns off.

Autumn Colors



Captures the brilliant reds and yellows in autumn leaves.

Note


The built-in flash turns off.

Food



Use for vivid photographs of food.

Note






For flash photography, press the  (64) button to raise the flash (64).





Preventing Blur

Use a tripod to prevent blur caused by camera shake at slow shutter speeds.

Special Effects

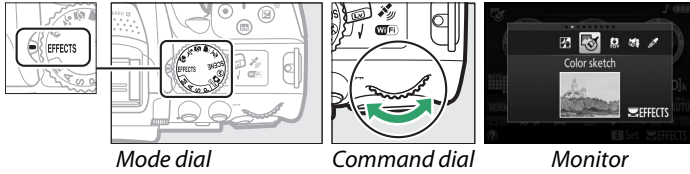
Special effects can be used when recording images.

-  Night Vision
-  Color Sketch
-  Toy Camera Effect
-  Miniature Effect
-  Selective Color

-  Silhouette
-  High Key
-  Low Key
-  HDR Painting



The following effects can be selected by rotating the mode dial to **EFFECTS** and rotating the command dial until the desired option appears in the monitor.



Mode dial

Command dial

Monitor

Night Vision



Use under conditions of darkness to record monochrome images at high ISO sensitivities.

Note

Pictures may be affected by noise in the form of randomly-spaced bright pixels, fog, or lines. Autofocus is available in live view only; manual focus can be used if the camera is unable to focus. The built-in flash and AF-assist illuminator turn off.

Color Sketch



The camera detects and colors outlines for a color sketch effect. The effect can be adjusted in live view (☞ 41).

Note

Movies shot in this mode play back like a slide show made up of a series of stills.

Toy Camera Effect



Create photos and movies that appear to have been shot with a toy camera. The effect can be adjusted in live view (☞ 42).

Miniature Effect



Create photos that appear to be pictures of dioramas. Works best when shooting from a high vantage point. Miniature effect movies play back at high speed, compressing about 45 minutes of footage shot at 1920 × 1080/30p into a movie that plays back in about three minutes. The effect can be adjusted in live view (☞ 42).

Note

Sound is not recorded with movies. The built-in flash and AF-assist illuminator turn off.

Selective Color



All colors other than the selected colors are recorded in black and white. The effect can be adjusted in live view (📖 43).

Note

The built-in flash turns off.

Silhouette



Silhouette subjects against bright backgrounds.

Note

The built-in flash turns off.

High Key



Use with bright scenes to create bright images that seem filled with light.

Note

The built-in flash turns off.

Low Key



Use with dark scenes to create dark, low-key images with prominent highlights.

Note


The built-in flash turns off.

HDR Painting









Each time a photo is taken, the camera shoots two frames at different exposures and combines them for a painterly effect that emphasizes detail and color.

Note

The effect can not be previewed in live view. Note that the desired results may not be achieved if the camera or subject move during shooting. During recording, a message is displayed and no further photos can be taken. The built-in flash turns off, continuous shooting is disabled, and movies are recorded in  mode.

NEF (RAW)

NEF (RAW) recording is not available in , , , , , and  modes. Pictures taken when an NEF (RAW) or NEF (RAW)+JPEG option is selected in these modes will be recorded as JPEG images. JPEG images created at settings of NEF (RAW)+JPEG will be recorded at the selected JPEG quality, while images recorded at a setting of NEF (RAW) will be recorded as fine-quality images.

and Modes

Autofocus is not available during movie recording. The live view refresh rate will drop, together with the frame rate for continuous release modes; using autofocus during live view photography will disrupt the preview.

Preventing Blur

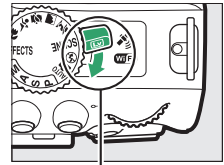
Use a tripod to prevent blur caused by camera shake at slow shutter speeds.

Options Available in Live View

■ ■ Color Sketch

1 Select live view.

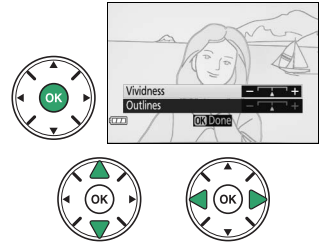
Rotate the live view switch. The view through the lens will be displayed in the monitor.



Live view switch

2 Adjust options.

Press **OK** to display the options shown at right. Press **▲** or **▼** to highlight **Vividness** or **Outlines** and press **◀** or **▶** to change. Vividness can be increased to make colors more saturated, or decreased for a washed-out, monochromatic effect, while outlines can be made thicker or thinner. Increasing the thickness of the lines also makes colors more saturated.



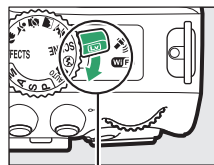
3 Press **OK**.

Press **OK** to exit when settings are complete. To exit live view, rotate the live view switch. The selected settings will continue in effect and will apply to photographs taken using the viewfinder.

Toy Camera Effect

1 Select live view.

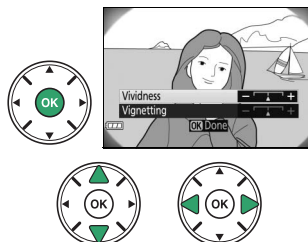
Rotate the live view switch. The view through the lens will be displayed in the monitor.



Live view switch

2 Adjust options.

Press **OK** to display the options shown at right. Press **▲** or **▼** to highlight **Vividness** or **Vignetting** and press **◀** or **▶** to change. Adjust vividness to make colors more or less saturated, vignetting to control the amount of vignetting.



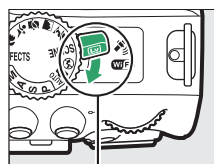
3 Press **OK**.

Press **OK** to exit when settings are complete. To exit live view, rotate the live view switch. The selected settings will continue in effect and will apply to photographs taken using the viewfinder.

Miniature Effect

1 Select live view.

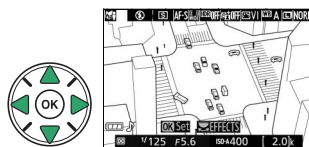
Rotate the live view switch. The view through the lens will be displayed in the monitor.



Live view switch

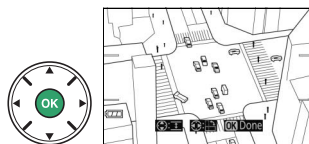
2 Position the focus point.

Use the multi selector to position the focus point in the area that will be in focus and then press the shutter-release button halfway to focus. To temporarily clear miniature effect options from the display and enlarge the view in the monitor for precise focus, press . Press (?) to restore the miniature effect display.



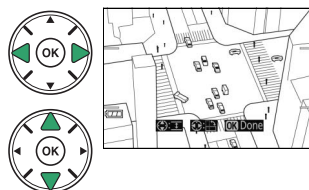
3 Display options.

Press to display miniature effect options.



4 Adjust options.

Press or to choose the orientation of the area that will be in focus and press or to adjust its width.



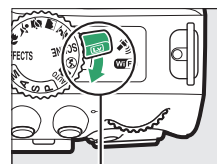
5 Return to the live view display.

Press to return to live view. To exit live view, rotate the live view switch. The selected settings will continue in effect and will apply to photographs taken using the viewfinder.

Selective Color

1 Select live view.

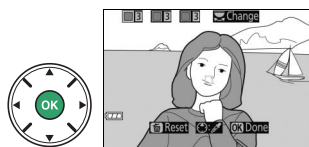
Rotate the live view switch. The view through the lens will be displayed in the monitor.



Live view switch

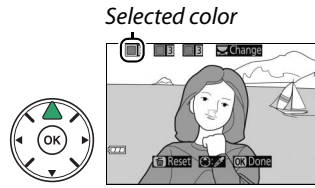
2 Display options.

Press to display selective color options.



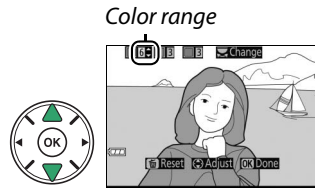
3 Select a color.

Frame an object in the white square in the center of the display and press ▲ to choose the color of the object as one that will remain in the final image (the camera may have difficulty detecting unsaturated colors; choose a saturated color). To zoom in on the center of the display for more precise color selection, press Q. Press Q (?) to zoom out.



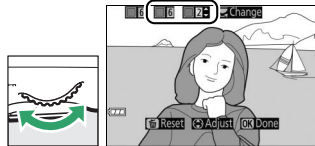
4 Choose the color range.

Press ▲ or ▼ to increase or decrease the range of similar hues that will be included in the final image. Choose from values between 1 and 7; note that higher values may include hues from other colors.



5 Select additional colors.

To select additional colors, rotate the command dial to highlight another of the three color boxes at the top of the display and repeat Steps 3 and 4 to select another color. Repeat for a third color if desired. To deselect the highlighted color, press ⇧ (To remove all colors, press and hold ⇧. A confirmation dialog will be displayed; select **Yes**).





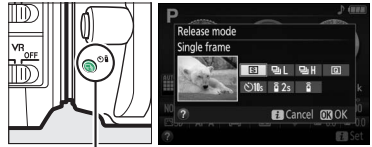
6 Return to the live view display.

Press OK to return to live view. During shooting, only objects of the selected hues will be recorded in color; all others will be recorded in black-and-white. To exit live view, rotate the live view switch. The selected settings will continue in effect and will apply to photographs taken using the viewfinder.








More on Photography

Choosing a Release Mode

To choose how the shutter is released (release mode), press the  (☺/Ⓜ) button, then highlight the desired option and press .



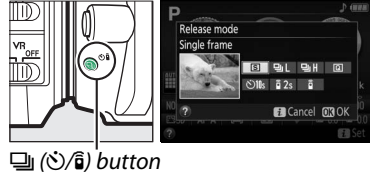
 (☺/Ⓜ) button

Mode	Description
	Single frame: Camera takes one photograph each time shutter-release button is pressed.
	Continuous L: The camera takes photographs at a slow rate while the shutter-release button is pressed (□ 46).
	Continuous H: The camera takes photographs at a fast rate while the shutter-release button is pressed (□ 46).
	Quiet shutter release: As for single-frame, except that camera noise is reduced (□ 48).
	Self-timer: Take pictures with the self-timer (□ 49).
	Delayed remote (ML-L3): Shutter is released 2 s after shutter-release button on optional ML-L3 remote control is pressed (□ 70).
	Quick-response remote (ML-L3): Shutter is released when shutter-release button on optional ML-L3 remote control is pressed (□ 70).

Continuous Shooting (Burst Mode)

In **L** (**Continuous L**) and **H** (**Continuous H**) modes, the camera takes photographs continuously while the shutter-release button is pressed all the way down.

- 1 Press the **L** (**OK**) button.



- 2 Choose a continuous release mode.
Highlight **L** (**Continuous L**) or **H** (**Continuous H**) and press **OK**.



- 3 Focus.
Frame the shot and focus.



- 4 Take photographs.
The camera will take photographs while the shutter-release button is pressed all the way down.




The Memory Buffer

The camera is equipped with a memory buffer for temporary storage, allowing shooting to continue while photographs are being saved to the memory card. Up to 100 photographs can be taken in succession. Depending on the battery level and the number of images in the buffer, recording may take from a few seconds to a few minutes. If the battery is exhausted while images remain in the buffer, the shutter release will be disabled and the images transferred to the memory card.

Frame Rate

For information on the number of photographs can be taken in continuous release modes, see page 260. Frame rates may drop when the memory buffer is full or the battery is low.

The Built-in Flash

Continuous release modes can not be used with the built-in flash; rotate the mode dial to  (☐ 19) or turn the flash off (☐ 62).


Buffer Size

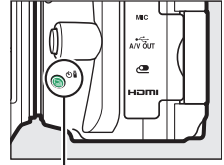
The approximate number of images that can be stored in the memory buffer at current settings is shown in the viewfinder exposure-count display while the shutter-release button is pressed.




Quiet Shutter Release

Choose this mode to keep camera noise to a minimum. A beep does not sound when the camera focuses.

- 1** Press the  (🔇/🔇) button.



 (🔇/🔇) button

- 2** Select  (Quiet shutter release).
Highlight  (Quiet shutter release) and press .



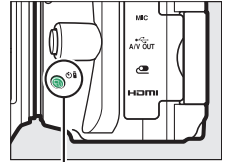
- 3** Press the shutter-release button all the way down.
Press the shutter-release button all the way down to shoot.






Self-Timer Mode

The self-timer can be used for self-portraits or group shots that include the photographer. Before proceeding, mount the camera on a tripod or place it on a stable, level surface.

1 Press the  (/) button.



 (/) button

2 Select  (Self-timer) mode.
Highlight  (Self-timer) and press .

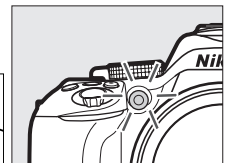


3 Frame the photograph.



4 Take the photograph.

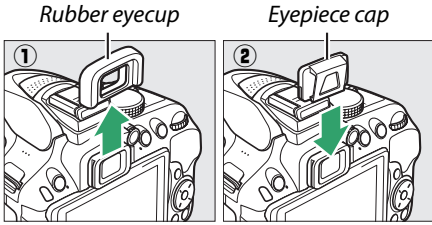
Press the shutter-release button halfway to focus, and then press the button the rest of the way down. The self-timer lamp will start to flash and a beep will begin to sound. Two seconds before the photo is taken, the lamp will stop flashing and the beeping will become more rapid. The shutter will be released ten seconds after the timer starts.





Note that the timer may not start or a photograph may not be taken if the camera is unable to focus or in other situations in which the shutter can not be released. To stop the timer without taking a photograph, turn the camera off.

Cover the Viewfinder

When taking photos without your eye to the viewfinder, remove the rubber eyecup (1) and insert the supplied eyepiece cap as shown (2). This prevents light entering via the viewfinder interfering with exposure.



Using the Built-in Flash

Before taking a photograph with the flash in modes that require the flash to be raised manually, press the  (182) button to raise the flash and wait for the  indicator to be displayed in the viewfinder (183). Shooting will be interrupted if the flash is raised after the self-timer has started.

Custom Setting c3 (Self-Timer)

For information on choosing the duration of the self-timer and the number of shots taken, see Custom Setting c3 (**Self-timer**; 187).

Focus (Viewfinder Photography)

This section describes the focus options available when photographs are framed in the viewfinder. Focus can be adjusted automatically or manually (see “Focus Mode,” below). The user can also select the focus point for automatic or manual focus (☐ 55) or use focus lock to focus to recompose photographs after focusing (☐ 55).

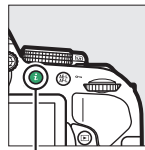
Choosing How the Camera Focuses: Focus Mode

Choose from the following focus modes. Note that **AF-S** and **AF-C** are available only in modes **P**, **S**, **A**, and **M**.

Option	Description
AF-A Auto-servo AF	Camera automatically selects single-servo autofocus if subject is stationary, continuous-servo autofocus if subject is moving. Shutter can only be released if camera is able to focus.
AF-S Single-servo AF	For stationary subjects. Focus locks when shutter-release button is pressed halfway. Shutter can only be released if camera is able to focus.
AF-C Continuous-servo AF	For moving subjects. Camera focuses continuously while shutter-release button is pressed halfway. At default settings, shutter can only be released if camera is able to focus (☐ 184).
MF Manual focus	Focus manually (☐ 57).

1 Display focus mode options.

Press the **i** button, then highlight the current focus mode in the information display and press **OK**.



i button

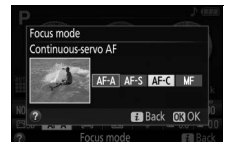


Information display



2 Choose a focus mode.


Highlight a focus mode and press **OK**.





Predictive Focus Tracking

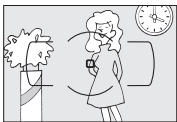
In **AF-C** mode or when continuous-servo autofocus is selected in **AF-A** mode, the camera will initiate predictive focus tracking if the subject moves toward the camera while the shutter-release button is pressed halfway. This allows the camera to track focus while attempting to predict where the subject will be when the shutter is released.

Continuous-Servo Autofocus

When **Focus** is selected for Custom Setting a1 (**AF-C priority selection**;  184) and the camera is in **AF-C** mode or continuous-servo autofocus is selected in **AF-A** mode, the camera gives higher priority to focus response (has a wider focus range) than in **AF-S** mode, and the shutter may be released before the in-focus indicator is displayed.

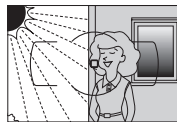
Getting Good Results with Autofocus

Autofocus does not perform well under the conditions listed below. The shutter release may be disabled if the camera is unable to focus under these conditions, or the in-focus indicator (●) may be displayed and the camera may sound a beep, allowing the shutter to be released even when the subject is not in focus. In these cases, focus manually ( 57) or use focus lock ( 55) to focus on another subject at the same distance and then recompose the photograph.



There is little or no contrast between the subject and the background.

Example: Subject is the same color as the background.



The focus point contains areas of sharply contrasting brightness.

Example: Subject is half in the shade.



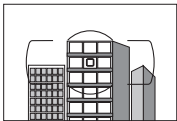
The focus point contains objects at different distances from the camera.

Example: Subject is inside a cage.



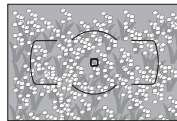
Background objects appear larger than the subject.

Example: A building is in the frame behind the subject.



The subject is dominated by regular geometric patterns.


Example: Blinds or a row of windows in a skyscraper.



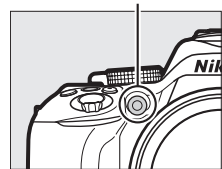
The subject contains many fine details.

Example: A field of flowers or other subjects that are small or lack variation in brightness.

The AF-Assist Illuminator

If the subject is poorly lit, the AF-assist illuminator will light automatically to assist the autofocus operation when the shutter-release button is pressed halfway (some restrictions apply;  252). Note that the illuminator may become hot when used multiple times in quick succession and will turn off automatically to protect the lamp after a period of continuous use. Normal function will resume after a brief pause.

AF-assist illuminator



Choosing How the Focus Point Is Selected:

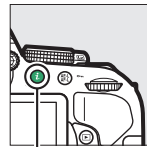
AF-Area Mode

Choose how the focus point for autofocus is selected. Note that [∞] (dynamic-area) and [3D] (3D-tracking) AF-area modes are not available when **AF-S** is selected for focus mode.

Option	Description
[∞] Single-point AF	For stationary subjects. Focus point is selected manually; camera focuses on subject in selected focus point only.
[9] Dynamic-area AF (9 points)	For non-stationary subjects. In AF-A and AF-C focus modes , user selects focus point using multi selector (□ 55), but camera will focus based on information from surrounding focus points if subject briefly leaves selected point. Number of focus points varies with mode selected: <ul style="list-style-type: none"> • 9-point dynamic-area AF: Choose when there is time to compose photograph or when photographing subjects that are moving predictably (e.g., runners or race cars on a track). • 21-point dynamic-area AF: Choose when photographing subjects that are moving unpredictably (e.g., players at a football game). • 39-point dynamic-area AF: Choose when photographing subjects that are moving quickly and are hard to keep in frame (e.g., birds).
[21] Dynamic-area AF (21 points)	
[39] Dynamic-area AF (39 points)	
[3D] 3D-tracking	Quickly compose pictures with subjects that are moving erratically from side to side (e.g., tennis players). In AF-A and AF-C focus modes , user selects focus point using multi selector (□ 55). If subject moves after camera has focused, camera uses 3D-tracking to select new focus point and keep focus locked on original subject while shutter-release button is pressed halfway.
[] Auto-area AF	Camera automatically detects subject and selects focus point.

1 Display AF-area mode options.

Press the **i** button, then highlight the current AF-area mode in the information display and press **OK**.



i button



Information display



2 Choose an AF-area mode.

Highlight an option and press **OK**.



AF-Area Mode

AF-area mode selections made in shooting modes other than **P**, **S**, **A**, or **M** are reset when another shooting mode is selected.

3D-Tracking

If subject leaves the viewfinder, remove your finger from the shutter-release button and recompose the photograph with the subject in the selected focus point. Note that when the shutter-release button is pressed halfway, the colors in the area surrounding the focus point are stored in the camera. Consequently 3D-tracking may not produce the desired results with subjects that are the same color as the background.

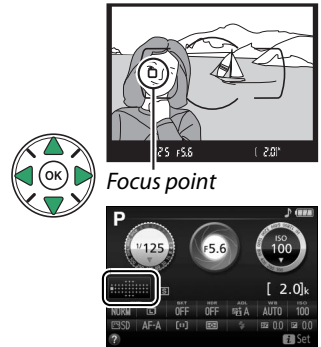
Focus Point Selection

In manual focus mode or when autofocus is combined with AF-area modes other than **[]** (Auto-area AF), you can choose from 39 focus points, making it possible to compose photographs with the main subject almost anywhere in the frame.

- 1 Choose an AF-area mode other than **[]** (Auto-area AF; [53](#)).



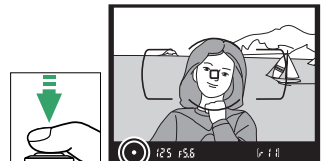
- 2 Select the focus point.
Use the multi selector to select the focus point in the viewfinder or information display while the exposure meters are on. Press **OK** to select the center focus point.



Focus Lock

Focus lock can be used to change the composition after focusing in **AF-A**, **AF-S**, and **AF-C** focus modes ([51](#)), making it possible to focus on a subject that will not be in a focus point in the final composition. If the camera is unable to focus using autofocus ([52](#)), focus lock can also be used to recompose the photograph after focusing on another object at the same distance as your original subject. Focus lock is most effective when an option other than **[]** (Auto-area AF) is selected for AF-area mode ([53](#)).

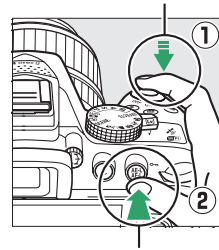
- 1 Focus.
Position the subject in the selected focus point and press the shutter-release button halfway to initiate focus. Check that the in-focus indicator (●) appears in the viewfinder.



2 Lock focus.

AF-A and AF-C focus modes: With the shutter-release button pressed halfway (①), press the AE-L/AF-L (O- \blacktriangleright) button (②) to lock focus. Focus will remain locked while the AE-L/AF-L (O- \blacktriangleright) button is pressed, even if you later remove your finger from the shutter-release button.

Shutter-release button

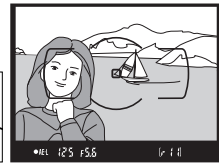


AE-L/AF-L (O- \blacktriangleright) button

AF-S focus mode: Focus will lock automatically when the in-focus indicator appears, and remain locked until you remove your finger from the shutter-release button. Focus can also be locked by pressing the AE-L/AF-L (O- \blacktriangleright) button (see above).

3 Recompose the photograph and shoot.

Focus will remain locked between shots if you keep the shutter-release button pressed halfway (AF-S) or keep the AE-L/AF-L (O- \blacktriangleright) button pressed, allowing several photographs in succession to be taken at the same focus setting.



Do not change the distance between the camera and the subject while focus lock is in effect. If the subject moves, focus again at the new distance.

Autoexposure Lock

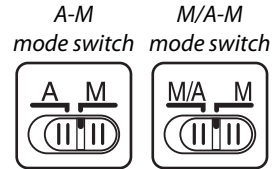
Pressing the AE-L/AF-L (O- \blacktriangleright) button in Step 2 also locks exposure (□ 91).

Manual Focus

Manual focus can be used when autofocus is not available or does not produce the desired results (☞ 52).

1 Select manual focus.

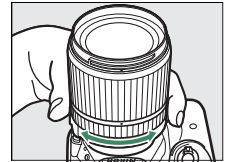
If the lens is equipped with an A-M, M/A-M, or A/M-M mode switch, slide the switch to **M**.



If the lens is not equipped a focus-mode switch, select **MF** (manual focus) for **Focus mode** (☞ 51).

2 Focus.

To focus manually, adjust the lens focus ring until the image displayed on the clear matte field in the viewfinder is in focus. Photographs can be taken at any time, even when the image is not in focus.




■ The Electronic Rangefinder

If the lens has a maximum aperture of $f/5.6$ or faster, the viewfinder focus indicator can be used to confirm whether the subject in the selected focus point is in focus (the focus point can be selected from any of the 39 focus points). After positioning the subject in the selected focus point, press the shutter-release button halfway and rotate the lens focus ring until the in-focus indicator (●) is displayed. Note that with the subjects listed on page 52, the in-focus indicator may sometimes be displayed when the subject is not in focus; confirm focus in the viewfinder before shooting.



Selecting Manual Focus with the Camera

If the lens supports M/A (autofocus with manual override) or A/M (autofocus with manual override/AF priority), manual focus can also be selected by setting the camera focus mode to **MF** (manual focus;  51). Focus can then be adjusted manually, regardless of the mode selected with the lens.



Focal Plane Position

The position of the focal plane is indicated by the focal plane mark on the camera body. The distance between the lens mounting flange and the focal plane is 46.5 mm (1.83 in.).

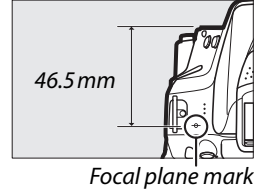


Image Quality and Size

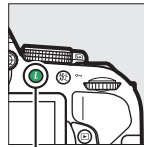
Together, image quality and size determine how much space each photograph occupies on the memory card. Larger, higher quality images can be printed at larger sizes but also require more memory, meaning that fewer such images can be stored on the memory card (□ 281).

Image Quality

Choose a file format and compression ratio (image quality).

Option	File type	Description
NEF (RAW) + JPEG fine		Two images are recorded: one NEF (RAW) image and one fine-quality JPEG image.
NEF (RAW) + JPEG normal	NEF/ JPEG	Two images are recorded: one NEF (RAW) image and one normal-quality JPEG image.
NEF (RAW) + JPEG basic		Two images are recorded: one NEF (RAW) image and one basic-quality JPEG image.
NEF (RAW)	NEF	Raw data from the image sensor are saved directly to the memory card. Settings such as white balance and contrast can be adjusted after shooting.
JPEG fine		Record JPEG images at a compression ratio of roughly 1 : 4 (fine quality).
JPEG normal	JPEG	Record JPEG images at a compression ratio of roughly 1 : 8 (normal quality).
JPEG basic		Record JPEG images at a compression ratio of roughly 1 : 16 (basic quality).

- 1 Display image quality options.**
Press the **i** button, then highlight the current image quality in the information display and press **OK**.



i button



Information display



- 2 Choose a file type.**
Highlight an option and press **OK**.



NEF (RAW) Images

Note that the option selected for image size does not affect the size of NEF (RAW) images. White balance bracketing (☐ 108), high dynamic range (HDR, ☐ 96), and print date (☐ 190) are not available at image quality settings of NEF (RAW) or NEF (RAW)+JPEG.




NEF (RAW) images can be viewed on the camera or using software such as Capture NX 2 (available separately; ☐ 236) or ViewNX 2 (supplied). JPEG copies of NEF (RAW) images can be created using the **NEF (RAW) processing** option in the retouch menu (☐ 213).

NEF (RAW) + JPEG

When photographs taken at NEF (RAW) + JPEG are viewed on the camera, only the JPEG image will be displayed. When photographs taken at these settings are deleted, both NEF and JPEG images will be deleted.

Image Size

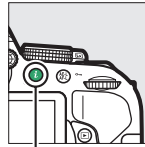
Choose a size for JPEG images:

Image size	Size (pixels)	Print size (cm/in.)*
 Large	6000 × 4000	50.8 × 33.9/20 × 13.3
 Medium	4496 × 3000	38.1 × 25.4/15.0 × 10
 Small	2992 × 2000	25.3 × 16.9/10 × 6.7

* Approximate size when printed at 300 dpi. Print size in inches equals image size in pixels divided by printer resolution in dots per inch (dpi; 1 inch=approximately 2.54 cm).

1 Display image size options.

Press the **i** button, then highlight the current image size in the information display and press **OK**.



i button

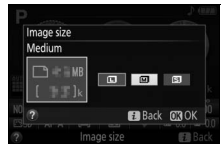


Information display



2 Choose an image size.









Highlight an option and press **OK**.




Using the Built-in Flash

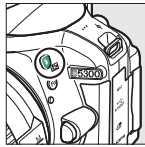
The camera supports a variety of flash modes for photographing poorly lit or backlit subjects.


Auto Pop-up Modes

In **AUTO**, , , , , , , , and  modes, the built-in flash automatically pops up and fires as required.

1 Choose a flash mode.

Keeping the  button pressed, rotate the command dial until the desired flash mode appears in the information display.



 button

+



Command dial

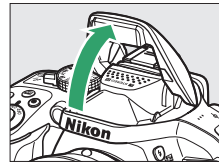
→



Information display





2 Take pictures.

The flash will pop up as required when the shutter-release button is pressed halfway, and fire when a photograph is taken. *If the flash does not pop up automatically, DO NOT attempt to raise it by hand. Failure to observe this precaution could damage the flash.*



■ Flash Modes

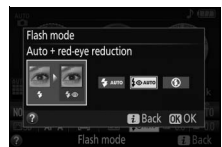
The following flash modes are available:

- **⚡ AUTO** (auto flash): When lighting is poor or the subject is backlit, the flash pops up automatically when the shutter-release button is pressed halfway and fires as required. Not available in  mode.
- **⚡👁️ AUTO** (auto with red-eye reduction): Use for portraits. The flash pops up and fires as required, but before it fires the red-eye reduction lamp lights to help reduce “red-eye.” Not available in  mode.
- **🔌** (off): The flash does not fire.
- **⚡👁️ AUTO SLOW** (auto slow sync with red-eye reduction): As for auto with red-eye reduction, except that slow shutter speeds are used to capture background lighting. Use for portraits taken at night or under low light. Available in  mode.
- **⚡ AUTO SLOW** (auto slow sync): Slow shutter speeds are used to capture background lighting in shots taken at night or under low light. Available in  mode.



The Information Display

Flash mode can also be selected in the information display.

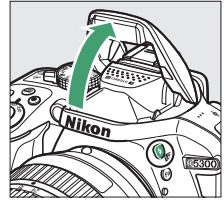



Manual Pop-up Modes

In P, S, A, M, and \uparrow modes, the flash must be raised manually. The flash will not fire if it is not raised.


1 Raise the flash.

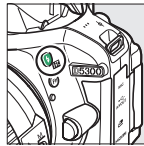
Press the  button to raise the flash.




 button

2 Choose a flash mode (P, S, A, and M modes only).

Keeping the  button pressed, rotate the command dial until the desired flash mode appears in the information display.



 button

+



Command dial



Information display

3 Take pictures.

The flash will fire whenever a picture is taken.

■ Flash Modes

The following flash modes are available:

- **⚡** (fill flash): The flash fires with every shot.
- **⚡👁** (red-eye reduction): Use for portraits. The flash fires with every shot, but before it fires, the red-eye reduction lamp lights to help reduce “red-eye.” Not available in **¶¶** mode.
- **⚡👁SLOW** (red-eye reduction with slow sync): As for “red-eye reduction”, above, except that shutter speed slows automatically to capture background lighting at night or under low light. Use when you want to include background lighting in portraits. Not available in modes **S, M,** and **¶¶**.
- **⚡SLOW** (slow sync): As for “fill flash”, above, except that shutter speed slows automatically to capture background lighting at night or under low light. Use when you want to capture both subject and background. Not available in modes **S, M,** and **¶¶**.
- **⚡SLOW REAR** (slow rear-curtain sync): As for “rear-curtain sync”, below, except that shutter speed slows automatically to capture background lighting at night or under low light. Use when you want to capture both subject and background. Not available in modes **S, M,** and **¶¶**.
- **⚡REAR** (rear-curtain sync): The flash fires just before the shutter closes, creating a stream of light behind moving light sources as shown below at right. Not available in modes **P, A,** and **¶¶**.



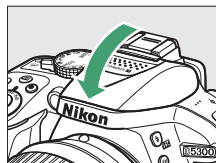
Front-curtain sync



Rear-curtain sync

Lowering the Built-in Flash

To save power when the flash is not in use, press it gently downward until the latch clicks into place.
















The Built-in Flash


For information on the lenses that can be used with the built-in flash, see page 230. Remove lens hoods to prevent shadows. The flash has a minimum range of 0.6 m (2 ft) and can not be used in the macro range of zoom lenses with a macro function.


The shutter release may be briefly disabled to protect the flash after it has been used for several consecutive shots. The flash can be used again after a short pause.

Shutter Speeds Available with the Built-in Flash

Shutter speed is restricted to the following ranges when the built-in flash is used:

Mode	Shutter speed	Mode	Shutter speed
AUTO,  ,  ,  ,  ,  ,  ,  ,  ,  , 	$1/200$ – $1/60$ s	S	$1/200$ –30 s
 , 		M	$1/200$ –30 s, Bulb, Time
	$1/200$ –1 s		

Shutter speeds as slow as $1/30$ s are available in mode  when vibration reduction is on.

Shutter speeds as slow as 30 s are available in modes **P** and **A** when slow sync, rear curtain + slow sync, or slow sync + red-eye reduction is selected ( 65).

Aperture, Sensitivity, and Flash Range

Flash range varies with sensitivity (ISO equivalency) and aperture.

Aperture at ISO equivalent of								Approximate range	
100	200	400	800	1600	3200	6400	12800	m	ft
1.4	2	2.8	4	5.6	8	11	16	1.0–8.5	3ft 3in.–27ft 11in.
2	2.8	4	5.6	8	11	16	22	0.7–6.0	2ft 4in.–19ft 8in.
2.8	4	5.6	8	11	16	22	32	0.6–4.2	2ft–13ft 9in.
4	5.6	8	11	16	22	32	—	0.6–3.0	2ft–9ft 10in.
5.6	8	11	16	22	32	—	—	0.6–2.1	2ft–6ft 11in.
8	11	16	22	32	—	—	—	0.6–1.5	2ft–4ft 11in.
11	16	22	32	—	—	—	—	0.6–1.1	2ft–3ft 7in.
16	22	32	—	—	—	—	—	0.6–0.7	2ft–2ft 4in.

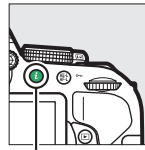
ISO Sensitivity

The camera's sensitivity to light can be adjusted according to the amount of light available. The higher the ISO sensitivity, the less light needed to make an exposure, allowing higher shutter speeds or smaller apertures. Noise (randomly-spaced bright pixels, fog, or lines) is however more likely at settings between Hi 0.3 (equivalent to ISO 16000) and Hi 1 (equivalent to ISO 25600). Choosing **Auto** allows the camera to set ISO sensitivity automatically in response to lighting conditions; to use auto in **P**, **S**, **A**, and **M** modes, select **Auto ISO sensitivity control** for the **ISO sensitivity settings** item in the shooting menu (☐ 180).

Mode	ISO sensitivity
AUTO,	Auto
P , S , A , M	100–12800 in steps of $\frac{1}{3}$ EV; Hi 0.3, Hi 0.7, Hi 1
Other shooting modes	Auto; 100–12800 in steps of $\frac{1}{3}$ EV; Hi 0.3, Hi 0.7, Hi 1

1 Display ISO sensitivity options.

Press the **i** button, then highlight the current ISO sensitivity in the information display and press **OK**.



i button

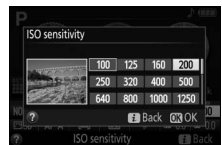


Information display



2 Choose an ISO sensitivity.

Highlight an option and press **OK**.



Interval Timer Photography

The camera is equipped to take photographs automatically at preset intervals.

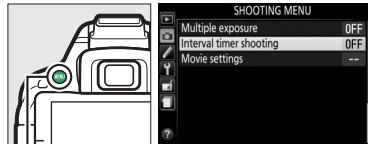
✓ Before Shooting

Before beginning interval timer photography, take a test shot at current settings and view the results in the monitor. To ensure that shooting starts at the desired time, check that the camera clock is set correctly (🕒 201).

Use of a tripod is recommended. Mount the camera on a tripod before shooting begins. To ensure that shooting is not interrupted, be sure the battery is fully charged.

1 Select Interval timer shooting.

Press the **MENU** button to display the menus. Highlight **Interval timer shooting** in the shooting menu and press **▶**.

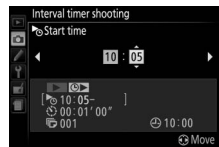
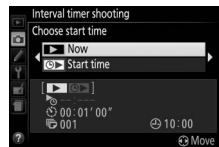


MENU button

2 Choose a starting time.

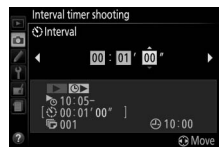
Choose from the following starting triggers.

- **To start shooting immediately**, highlight **Now** and press **▶**. Shooting begins about three seconds after settings are completed; proceed to Step 3.
- **To choose a starting time**, highlight **Start time** and press **▶** to display the start time options shown at right. Press **◀** or **▶** to highlight hours or minutes and press **▲** or **▼** to change. Press **▶** to continue.



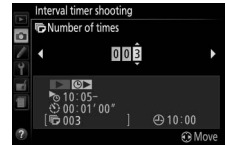
3 Choose the interval.

Press **◀** or **▶** to highlight hours, minutes, or seconds and press **▲** or **▼** to choose an interval longer than the slowest anticipated shutter speed. Press **▶** to continue.



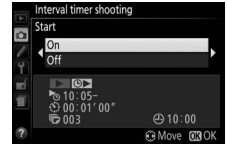
4 Choose the number of intervals.

Press ◀ or ▶ to highlight number of intervals (i.e., the number of times the camera shoots); press ▲ or ▼ to change. Press ▶ to continue.



5 Start shooting.

Highlight **On** and press **OK** (to return to the shooting menu without starting the interval timer, highlight **Off** and press **OK**). The first series of shots will be taken at the specified starting time, or after about 3 s if **Now** was selected for **Choose start time** in Step 2. Shooting will continue at the selected interval until all shots have been taken; while shooting is in progress, the memory card access lamp will flash at regular intervals. Note that because shutter speed and the time needed to record the image to the memory card may vary from shot to shot, intervals may be skipped if the camera is still in the process of recording the previous interval. If shooting can not proceed at current settings (for example, if a shutter speed of “Bulb” or “Time” is currently selected in shooting mode **M** or the start time is in less than a minute), a warning will be displayed in the monitor.



Cover the Viewfinder

To prevent light entering via the viewfinder interfering with exposure, remove the rubber eyecup and cover the viewfinder with the supplied eyepiece cap (□ 50).

Other Settings

Settings can not be adjusted during interval timer photography. Regardless of the release mode selected, the camera takes one photograph at each interval; in mode **[Q]**, camera noise will be reduced. Bracketing (□ 108), multiple exposure (□ 98), and high dynamic range (HDR; □ 96) can not be used.

Interrupting Interval Timer Photography

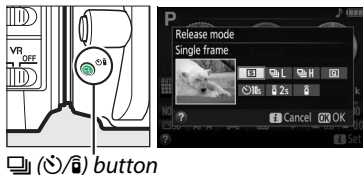
To interrupt interval timer shooting, turn the camera off or rotate the mode dial to a new setting. Returning the monitor to the storage position does not interrupt interval timer shooting.




Remote Control Photography

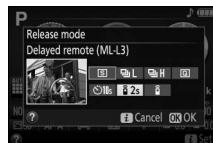
Using an Optional ML-L3 Remote Control

The optional ML-L3 remote control (☐ 237) can be used to reduce camera shake or for self-portraits. Before proceeding, mount the camera on a tripod or place it on a stable, level surface.

- 1 Press the  (☺/Ⓜ) button.



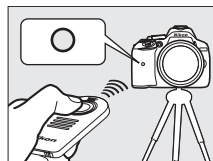
- 2 Select a remote control mode.
Highlight  2s (**Delayed remote (ML-L3)**) or  (**Quick-response remote (ML-L3)**) and press .



- 3 Frame the photograph.
Check focus by pressing the shutter-release button halfway.



- 4 Take the photograph.
From a distance of 5 m (16 ft) or less, aim the transmitter on the ML-L3 at either of the infrared receivers on the camera (☐ 1, 2) and press the ML-L3 shutter-release button. *In delayed remote mode*, the self-timer lamp will light for about two seconds before the shutter is released. *In quick-response remote mode*, the self-timer lamp will flash after the shutter has been released.



Note that the timer may not start or a photograph may not be taken if the camera is unable to focus or in other situations in which the shutter can not be released.

Before Using the ML-L3 Remote Control

Before using the ML-L3 for the first time, remove the clear plastic battery-insulator sheet.

Cover the Viewfinder

To prevent light entering via the viewfinder interfering with exposure, remove the rubber eyecup and cover the viewfinder with the supplied eyepiece cap (□ 50).



The Camera Shutter-Release Button/Other Remote Control Devices

If an ML-L3 remote release mode is selected and the shutter is released by any means other than an ML-L3 remote control (for example, the camera shutter-release button or the shutter button on an optional remote cord or wireless remote controller), the camera will function in single-frame release mode.

Exiting Remote Control Mode

Remote control mode is cancelled automatically if no photograph is taken before the time selected for Custom Setting c4 (**Remote on duration (ML-L3)**, □ 187). Remote control mode will also be cancelled if the camera is turned off, a two-button reset is performed (□ 72), or shooting options are reset using **Reset shooting menu**.

Using the Built-in Flash

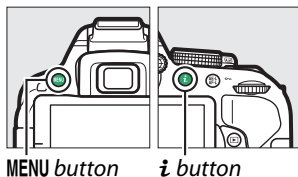
Before taking a photograph with the flash in manual pop-up modes (□ 64), press the  button to raise the flash and wait for the  indicator to be displayed in the viewfinder (□ 23). Shooting will be interrupted if the flash is raised after the shutter-release button on the ML-L3 is pressed. If the flash is required, the camera will only respond to the ML-L3 shutter-release button once the flash has charged. In auto pop-up modes, the flash will begin charging when a remote control mode is selected; once the flash is charged, it will automatically pop up and fire when required.

Wireless Remote Controllers

Remote control is also available with various combinations of WR-R10, WR-T10, and WR-1 wireless remote controllers (□ 237), when the shutter-release buttons on the wireless remote controllers perform the same functions as the camera shutter-release button. For more information, see the manual provided with the remote controllers.

Restoring Default Settings

The camera settings listed below and on page 73 can be restored to default values by holding the **MENU** and **i** buttons down together for more than two seconds (these buttons are marked by a green dot). The information display turns off briefly while settings are reset.







■ Settings Accessible from the Information Display






Option	Default	📖
Image quality	JPEG normal	59
Image size	Large	61
Auto bracketing		
P, S, A, M	Off	108
HDR (high dynamic range)		
P, S, A, M	Off	96
Active D-Lighting		
P, S, A, M	Auto	94
White balance		
P, S, A, M	Auto	101
ISO sensitivity		
P, S, A, M	100	67
	Auto	
Picture Control settings		
P, S, A, M	Unmodified*	111
Focus mode		
Viewfinder		
Shooting modes other than	AF-A	51
Live view/movie	AF-S	119

Option	Default	📖
AF-area mode		
Viewfinder		
	Single-point AF	53
	Dynamic-area AF (39 points)	
 P, S, A, M	Auto-area AF	
Live view/movie		
	Face-priority AF	120
 P, S, A, M	Wide-area AF	
	Normal-area AF	
Metering		
P, S, A, M	Matrix metering	90
Flash mode		
	Auto	63, 65
	Auto slow sync	
 P, S, A, M	Auto+red-eye reduction	
Flash compensation		
P, S, A, M	Off	93
Exposure compensation		
, P, S, A, M	Off	92

* Current Picture Control only.

■ ■ Other Settings

Option	Default	
Release mode		
	Continuous H	45
Other shooting modes	Single frame	
Focus point	Center	55
AE/AF lock hold		
Shooting modes other than  and 	Off	194
Flexible program		
P	Off	84
Multiple exposure		
Multiple exposure mode		
P, S, A, M	Off	98

Option	Default	
Special effects mode		
		
Vividness	0	41
Outlines	0	
		
Vividness	0	42
Vignetting	0	
		
Orientation	Landscape	42
Width	Normal	
		
Color	Off	43
Color range	3	

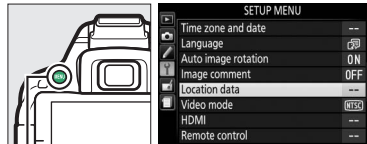
Location Data

Embedding Location Data in Photos and Movies

The built-in location data unit can record information on the camera's current position (latitude, longitude, altitude) and the current time (UTC) as provided by satellite navigation systems and embed it in photographs and movies taken with the camera. The location data function works best in locations that offer an unobstructed view of the sky.

1 Select Location data.

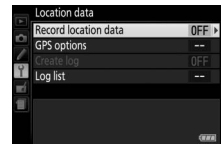
Press the **MENU** button to display the menus, then highlight **Location data** in the setup menu and press **▶**.



MENU button

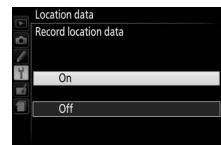
2 Select Record location data.

Highlight **Record location data** and press **▶**.



3 Select On.

Highlight **On** and press **OK** to enable the camera's built-in location data unit. The camera will begin receiving location data from navigation satellites.

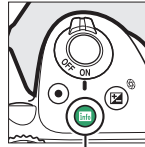


Before Enabling the Location Data Function

Before using the location data function, read the warnings on pages viii to xv and make sure that the clock is set to the correct time and date as described on page 201. To prevent the camera turning off unexpectedly, make sure the battery is charged.

4 Check satellite signal strength.

Press the **info** button and check satellite signal strength in the information display.



info button

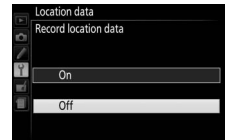


5 Take pictures.

The location data obtained via the navigation satellite system will be recorded with each photograph or movie taken and can be viewed in the playback photo info displays (□ 136) or plotted on a map using the supplied ViewNX 2 software (□ 154).




6 Turn the location data function off.

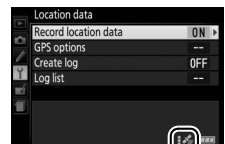
To turn the location data function off when it is no longer needed, select **Off** for **Location data** > **Record location data** in the setup menu.



The Satellite Signal Indicator

Signal strength is shown in the location data display as follows:

-  **(static)**: Camera records latitude, longitude, and altitude.
-  **(static)**: Camera records latitude and longitude only; altitude is not recorded.
-  **(flashing)**: Location not recorded.

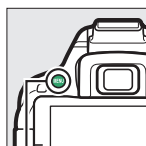


Track Logs

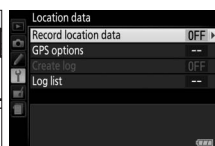
The built in location data unit can log information on the camera's current position (latitude, longitude, altitude) and the current time (UTC) as provided by satellite navigation systems. Location data are recorded automatically at preset intervals and saved to a track log file stored separately from the pictures taken with the camera. The supplied ViewNX 2 software (☞ 154) can then be used to view the track on a map.

1 Select On for Record location Data.

Press the **MENU** button to display the menus and select **Location data** > **Record location data** in the setup menu. Highlight **On** and press **OK**.

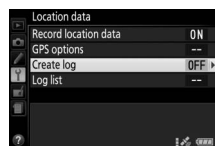


MENU button



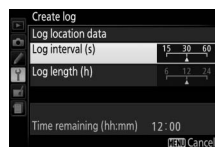
2 Select Create log.

Highlight **Create log** and press **▶**.



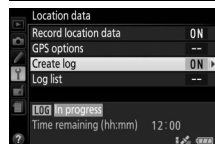
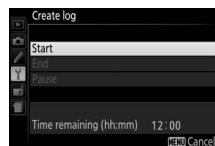
3 Choose the log interval and log length.

Highlight **Log interval (s)** and press **◀** or **▶** to choose how often the camera logs location data (the log interval, in seconds), then highlight **Log length (h)** and press **◀** or **▶** to choose how long (in hours) the log will continue.



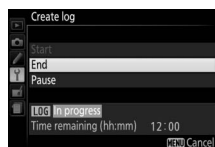
4 Start the log.

Highlight **Log location data** and press **▶**, then highlight **Start** and press **OK**. Location data will be logged at the interval and for the period chosen in Step 3. The time remaining is shown in the **Location data** display. Note that location data will be logged even when the standby timer has expired or the camera is off, increasing the drain on the battery.



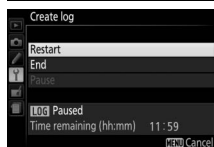
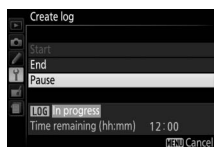
5 End the log.

To end the log and save it to the memory card before the selected log length is reached, select **Location data** > **Create log** > **Log location data**, then highlight **End** and press **OK**. The memory card access lamp will light while the camera saves the log to the memory card; do not remove the battery or memory card while the access lamp is lit.



Pausing Logs

To pause the log, select **Pause** in the **Create log** display. The log can be resumed by selecting **Restart**.



Logging Location Data

When tracking is active, the camera continues to monitor satellite signals even when off. To prevent logs being interrupted, be sure the camera battery is fully charged before enabling the tracking function.

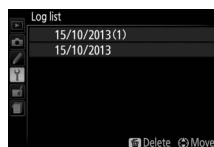
The Track Log Display

While tracking is active, the indicator at right appears in the information display.



Viewing Log Dates

Selecting **Log list** for **Location data** displays a list of the dates on which logs were recorded. In the case of dates with multiple logs, the individual logs are identified by number.

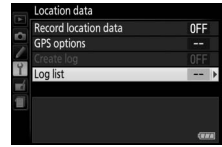


Deleting Logs

Follow the steps below to delete all or selected logs.

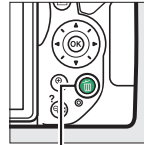
1 Select Log list.

Select **Location data** in the setup menu, then highlight **Log list** and press **OK**.

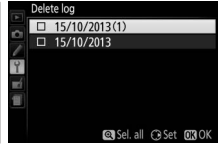


2 Press .

The dialog shown at right will be displayed.



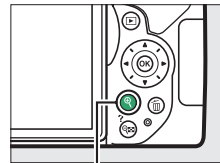
 button



3 Select logs.

To delete selected logs, highlight items in the list and press **▶** to select or deselect, and then press **OK** to proceed.

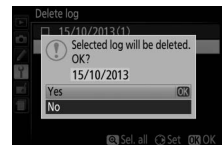
To delete all logs, press **⌘** and then press **OK**.



 button

4 Select Yes.

A confirmation dialog will be displayed; highlight **Yes** and press **OK** to delete the logs.



Copying Logs to a Computer

Logs are stored in the "NIKON" > "GNSS" folder on the memory card and have names consisting of "N" followed by the log date (yymmdd), a single-character identifier from 0 to Z assigned in ascending order by the camera, and the extension ".log" (thus the first log recorded on October 1 2013 will be named "N1310010.log"). Logs can be copied to a computer by inserting the memory card in a card reader or card slot and transferring the files using Nikon Transfer 2. Logs are in NMEA format but may not display correctly in some applications or on some devices.

GPS Options

Use the **Location data > GPS options** item in the setup menu to adjust settings for the built-in location data unit.

■ ■ Standby Timer

Choose whether or not to use the standby timer with the location data function.

Option	Description
Enable	Standby timer enabled; the camera will enter standby if no operations are performed for the time selected for Custom Setting c2 (Auto off timers ; □ 186) > Standby timer (to allow the camera time to acquire location data, the delay is extended by up to one minute after the standby timer is activated or the camera is turned on). This reduces the drain on the battery. Note that the camera will continue to acquire location data for a set period after the timer expires.
Disable	Standby timer disabled, ensuring uninterrupted recording of location data.

■ ■ Set Clock from Satellite

Choose **Yes** to set the camera clock based on the time provided by the satellite navigation system.

■ ■ Update A-GPS File

Using assisted GPS (A-GPS or aGPS) files reduces the time needed for the built-in location data unit to determine the current position. Assisted GPS files can be updated as described below.

1 Download the latest assisted GPS file.

Download the current assisted GPS file from the following URL:
<http://downloadcenter.nikonimglib.com/>

2 Copy the file to the “NIKON” folder on the memory card.

Insert the memory card in a card reader or card slot and copy the file to the “NIKON” folder in the root directory of the memory card (if the folder does not already exist, create a new folder and name it “NIKON”).

3 Insert the memory card in the camera.

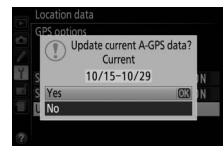
4 Turn the camera on.

5 Update the file.

In the camera setup menu, navigate to the **Location data > GPS options**, then highlight **Update A-GPS data** and press ►. Highlight **Yes** and press Ⓞ to update assisted GPS data. The update takes about two minutes.

✓ Expiry Date

Assisted GPS files remain valid for about two weeks after download and can not be used after their expiry date (an error message will be displayed if you attempt to use an out-of-date file). The expiry date for the current assisted GPS file can be viewed in the camera **Update A-GPS data** display. Update assisted GPS files before using the location data function; expired files can not be used to assist the acquisition of location data.



Location Data

Local geographic and atmospheric conditions may prevent or delay the acquisition of location data. The camera may be unable to receive location data indoors, underground, or in metal containers or the vicinity of bridges and other large structures, trees, power lines, or other objects that block or reflect satellite signals. Pay attention to your footing and surroundings when looking for locations with good reception. The positions of navigation satellites are continuously changing, preventing or delaying the acquisition of location data at certain hours of the day. The presence of cellular telephones or other devices that transmit on frequencies close to those of navigation satellites may also interfere with the acquisition of location data.

Note that in some cases the camera may take some time to acquire a signal, for example immediately after the battery is inserted or when the record location data function is enabled for the first time, or after an extended period of disuse. Location data for movies are for the start of recording. No data will be added to track logs while the camera is unable to receive location data; in addition, track logs will not be recorded if the clock is not set, the memory card is not inserted, or if any of the following operations are performed while the location data function is enabled: the battery runs low or is removed, **Off** is selected for **Location data > Record location data** in the setup menu, or an optional location data unit is connected. Note that turning the camera off does not disable the location data function.

Depending on the accuracy of the data acquired from the satellite system and the effects of local topography on satellite reception, the location data recorded with pictures may differ from the actual location by up to several hundred meters.

Connecting Optional Location Data Units

Optional Nikon location data units can be connected to the camera accessory terminal using the cable supplied with the unit (□ 237). Be sure the camera is off before connecting the unit. When an optional location data unit is attached, the built-in location data unit will be disabled and the camera will receive location data from the optional unit only, but the **Location data > GPS options > Standby timer** and **Set clock from satellite** option in the setup menu can still be used (□ 79). Track logs can not be created while an optional location data unit is connected.

See the manual provided with the location data unit for more information.

P, S, A, and M Modes

Shutter Speed and Aperture

P, S, A, and M modes offer different degrees of control over shutter speed and aperture:

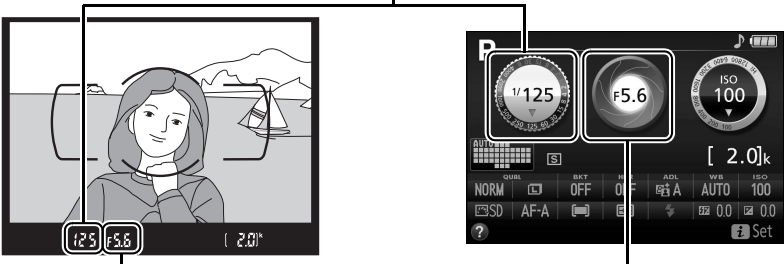


Mode		Description
P	Programmed auto (☞ 84)	Recommended for snapshots and in other situations in which there is little time to adjust camera settings. Camera sets shutter speed and aperture for optimal exposure.
S	Shutter-priority auto (☞ 85)	Use to freeze or blur motion. User chooses shutter speed; camera selects aperture for best results.
A	Aperture-priority auto (☞ 86)	Use to blur background or bring both foreground and background into focus. User chooses aperture; camera selects shutter speed for best results.
M	Manual (☞ 87)	User controls both shutter speed and aperture. Set shutter speed to “Bulb” or “Time” for long time-exposures.

Shutter Speed and Aperture

Shutter speed and aperture are shown in the viewfinder and information display.

Shutter speed



Aperture



Fast shutter speeds ($1/1600$ s in this example) freeze motion.



Slow shutter speeds (here 1 s) blur motion.



Large apertures (such as $f/5.6$; remember, the lower the f -number, the larger the aperture) blur details in front of and behind the main subject.



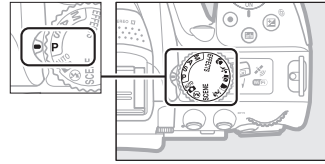
Small apertures ($f/22$ in this case) bring both background and foreground into focus.

Mode P (Programmed Auto)

This mode is recommended for snapshots or whenever you want to leave the camera in charge of shutter speed and aperture. The camera automatically adjusts shutter speed and aperture for optimal exposure in most situations.

To take pictures in programmed auto mode, rotate the mode dial to **P**.

Mode dial




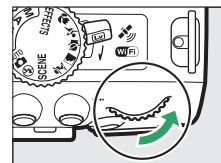
Flexible Program

In mode **P**, different combinations of shutter speed and aperture can be selected by rotating the command dial (“flexible program”). Rotate the dial right for large apertures (low f-numbers) and fast shutter speeds, left for small apertures (high f-numbers) and slow shutter speeds. All combinations produce the same exposure.

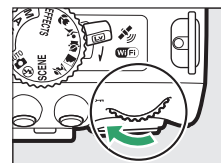
Rotate right to blur background details or freeze motion.

Rotate left to increase depth of field or blur motion.

While flexible program is in effect, a  (**P**) indicator appears in the viewfinder and information display. To restore default shutter speed and aperture settings, rotate the command dial until the indicator is no longer displayed, choose another mode, or turn the camera off.



Command dial



Mode S (Shutter-Priority Auto)

This mode lets you control shutter speed: choose fast shutter speeds to “freeze” motion, slow shutter speeds to suggest motion by blurring moving objects. The camera automatically adjusts aperture for optimal exposure.



Fast shutter speeds (e.g., $1/1600$ s) freeze motion.

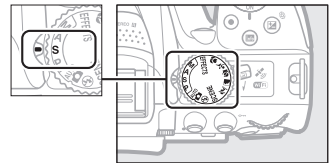


Slow shutter speeds (e.g., 1 s) blur motion.

To choose a shutter speed:

1 Rotate the mode dial to S.

Mode dial



2 Choose a shutter speed.

Rotate the command dial to choose the desired shutter speed: rotate right for faster speeds, left for slower speeds.



Command dial



Mode A (Aperture-Priority Auto)

In this mode, you can adjust aperture to control depth of field (the distance in front of and behind the main subject that appears to be in focus). The camera automatically adjusts shutter speed for optimal exposure.



Large apertures (low *f*-numbers, e.g. *f*/5.6) blur details in front of and behind the main subject.

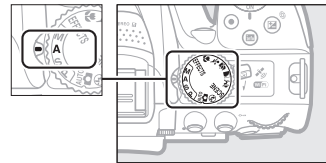


Small apertures (high *f*-numbers, e.g. *f*/22) bring the foreground and background into focus.

To choose an aperture:

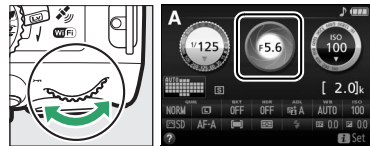
1 Rotate the mode dial to A.

Mode dial



2 Choose an aperture.

Rotate the command dial left for larger apertures (lower *f*-numbers), right for smaller apertures (higher *f*-numbers).



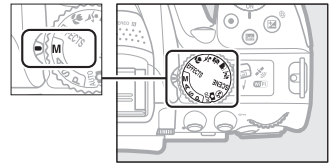
Command dial

Mode M (Manual)

In manual mode, you control both shutter speed and aperture. Shutter speeds of “Bulb” and “Time” are available for long time-exposures of moving lights, the stars, night scenery, or fireworks (☐ 88).

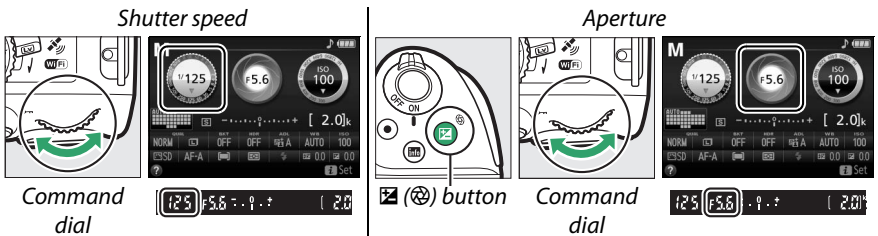
1 Rotate the mode dial to M.

Mode dial



2 Choose aperture and shutter speed.

Checking the exposure indicator (see below), adjust shutter speed and aperture. Shutter speed is selected by rotating the command dial (right for faster speeds, left for slower). To adjust aperture, keep the button pressed while rotating the command dial (left for larger apertures/lower f-numbers and right for smaller apertures/higher f-numbers).



The Exposure Indicator

If a CPU lens is attached (☐ 226) and a shutter speed other than “Bulb” or “Time” is selected, the exposure indicator in the viewfinder and information display shows whether the photograph would be under- or over-exposed at current settings.

Optimal exposure	Underexposed by 1/3 EV	Overexposed by over 2 EV
-. 0 . +	-. 0 . +	-. 0 ■■■▶

Long Time-Exposures (M Mode Only)

Select the following shutter speeds for long time-exposures of moving lights, the stars, night scenery, or fireworks.

- **Bulb (b u l b):** The shutter remains open while the shutter-release button is pressed all the way down. To prevent blur, use a tripod or an optional wireless remote controller (□ 237) or remote cord (□ 237).
- **Time (- -):** Start the exposure using the shutter-release button on the camera or on an optional remote control, remote cord, or wireless remote controller. The shutter remains open for thirty minutes or until the button is pressed a second time.



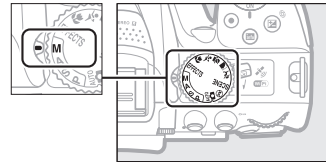
Length of exposure: 35 s
Aperture: f/25

Before proceeding, mount the camera on a tripod or place it on a stable, level surface. To prevent light entering via the viewfinder interfering with exposure, remove the rubber eyecup and cover the viewfinder with the supplied eyepiece cap (□ 50). To prevent loss of power before the exposure is complete, use a fully charged battery. Note that noise (bright spots, randomly-spaced bright pixels, or fog) may be present in long exposures; before shooting, choose **On** for **Long exposure NR** in the shooting menu (□ 179).

■ Bulb

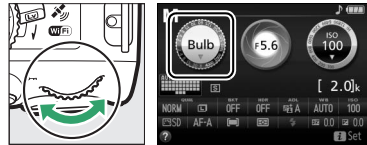
1 Rotate the mode dial to M.

Mode dial



2 Choose the shutter speed.

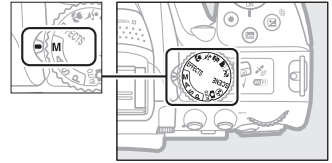
Rotate the command dial to choose a shutter speed of Bulb (b u l b).



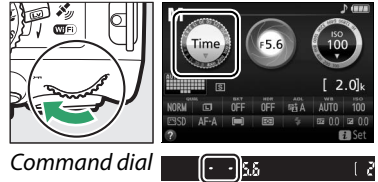
Command dial

3 Take the photograph.

After focusing, press the shutter-release button on the camera, optional wireless remote controller or remote cord all the way down. Take your finger from the shutter-release button when the exposure is complete.

1 Rotate the mode dial to M.*Mode dial***2 Choose the shutter speed.**

Rotate the command dial left to choose a shutter speed of “Time” (- -).

**3 Open the shutter.**

After focusing, press the shutter-release button on the camera or optional remote control, remote cord, or wireless remote controller all the way down.

4 Close the shutter.

Repeat the operation performed in Step 3 (shooting ends automatically if the button is not pressed after 30 minutes).




ML-L3 Remote Controls

If you will be using an ML-L3 remote control, select one of the following remote control modes as described on page 70: **2s (Delayed remote (ML-L3))** or **1 (Quick-response remote (ML-L3))**. Note that if you are using an ML-L3 remote control, pictures will be taken in “Time” mode even when “Bulb”/bulb is selected for shutter speed.

Exposure

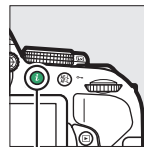
Metering

Choose how the camera sets exposure.

Method	Description
 Matrix metering	Produces natural results in most situations. The camera meters a wide area of the frame and sets exposure according to tone distribution, color, composition, and distance.
 Center-weighted metering	Classic meter for portraits. Camera meters entire frame but assigns greatest weight to center area. Recommended when using filters with an exposure factor (filter factor) over 1×.
 Spot metering	Choose this mode to ensure that subject will be correctly exposed, even when background is much brighter or darker. Camera meters current focus point; use to meter off-center subjects.

1 Display metering options.

Press the **i** button, then highlight the current metering method in the information display and press **OK**.



i button



Information display



2 Choose a metering method.





Highlight an option and press **OK**.



Spot Metering

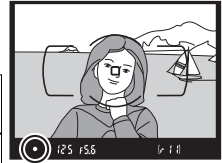
If **[AF]** (Auto-area AF) is selected for AF-area mode during viewfinder photography (53), the camera will meter the center focus point.

Autoexposure Lock


Use autoexposure lock to recompose photographs after using  (**Center-weighted metering**) and  (**Spot metering**) to meter exposure; note that autoexposure lock is not available in  or  mode.

1 Meter exposure.

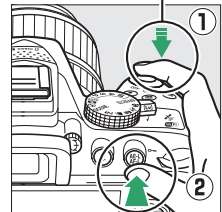
Press the shutter-release button halfway.




2 Lock exposure.

With the shutter-release button pressed halfway (1) and the subject positioned in the focus point, press the  button (2) to lock exposure.

Shutter-release button




 button

While exposure lock is in effect, an **AE-L** indicator will appear in the viewfinder.




3 Recompose the photograph.

Keeping the  button pressed, recompose the photograph and shoot.





Adjusting Shutter Speed and Aperture

While exposure lock is in effect, the following settings can be adjusted without altering the metered value for exposure:

Mode	Setting
Programmed auto	Shutter speed and aperture (flexible program;  84)
Shutter-priority auto	Shutter speed
Aperture-priority auto	Aperture

The metering method itself can not be changed while exposure lock is in effect.

Exposure Compensation

Exposure compensation is used to alter exposure from the value suggested by the camera, making pictures brighter or darker (□ 260). It is most effective when used with  (**Center-weighted metering**) or  (**Spot metering**) (□ 90).






-1 EV

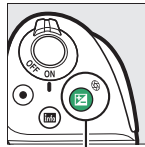




No exposure compensation

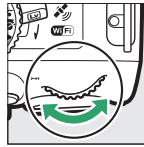


+1 EV

To choose a value for exposure compensation, keep the  () button pressed and rotate the command dial until the desired value is selected in the viewfinder or information display. Normal exposure can be restored by setting exposure compensation to ± 0 (adjustments to exposure compensation in  mode will be reset when another mode is selected). Exposure compensation is not reset when the camera is turned off.



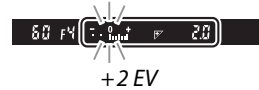
 () button



Command dial



-0.3 EV



+2 EV

The Information Display

Exposure compensation options can also be accessed from the information display (□ 7).



Mode M

In mode M, exposure compensation affects only the exposure indicator.

Using a Flash



When a flash is used, exposure compensation affects both background exposure and flash level.

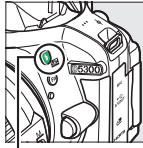
Bracketing



For information on automatically varying exposure over a series of shots, see page 108.

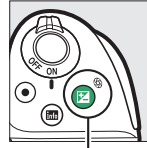
Flash Compensation


Flash compensation is used to alter flash output from the level suggested by the camera, changing the brightness of the main subject relative to the background. Flash output can be increased to make the main subject appear brighter, or reduced to prevent unwanted highlights or reflections (☞ 261).

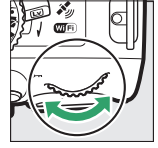
Keep the  and  buttons pressed and rotate the command dial until the desired value is selected in the viewfinder or information display. In general, positive values make the main subject seem brighter while negative values make it seem darker. Normal flash output can be restored by setting flash compensation to ± 0 . Flash compensation is not reset when the camera is turned off.



  button



 button



Command dial



-0.3 EV

+1 EV

The Information Display

Flash compensation options can also be accessed from the information display (☞ 7).





Optional Flash Units

Flash compensation is also available with optional flash units that support the Nikon Creative Lighting System (CLS; see page 232). The flash compensation selected with the optional flash unit is added to the flash compensation selected with the camera.

Preserving Detail in Highlights and Shadows

Active D-Lighting



Active D-Lighting preserves details in highlights and shadows, creating photographs with natural contrast. Use for high contrast scenes, for example when photographing brightly lit outdoor scenery through a door or window or taking pictures of shaded subjects on a sunny day. Active D-Lighting is not recommended in mode **M**; in other modes, it is most effective when used with  (**Matrix metering**;  90).

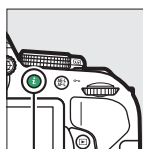


Active D-Lighting: OFF Off



Active D-Lighting:  A Auto

- 1 Display Active D-Lighting options.**
Press the  button, then highlight Active D-Lighting in the information display and press .





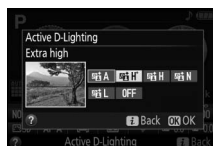
 button



Information display




- 2 Choose an option.**
Highlight an option and press  ( 261).



Active D-Lighting

Noise (randomly-spaced bright pixels, fog, or lines) may appear in photographs taken with Active D-Lighting. Uneven shading may be visible with some subjects. Active D-Lighting can not be used at ISO sensitivities of Hi 0.3 or above.



“Active D-Lighting” Versus “D-Lighting”

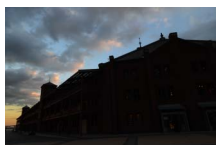
Active D-Lighting adjusts exposure before shooting to optimize the dynamic range, while the **D-Lighting** option in the retouch menu ( 207) brightens shadows in images after shooting.

Bracketing

For information on automatically varying Active D-Lighting over a series of shots, see page 108.

High Dynamic Range (HDR)

High Dynamic Range (HDR) combines two exposures to form a single image that captures a wide range of tones from shadows to highlights, even with high-contrast subjects. HDR is most effective when used with  (**Matrix metering**) ( 90). It can not be used to record NEF (RAW) images. While HDR is in effect, the flash can not be used and continuous shooting is not available.



First exposure (darker)

+





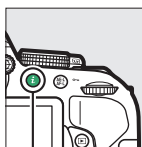
Second exposure (brighter)



Combined HDR image

1 Display HDR (High Dynamic Range) options.

Press the  button, then highlight HDR (High Dynamic Range) in the information display and press .




Info button

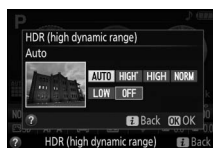


Information display



2 Choose an option.

Highlight **AUTO Auto**, **HIGH Extra high**, **HIGH High**, **NORM Normal**, **LOW Low**, or **OFF Off** and press .



When an option other than **OFF Off** is selected, **Hdr** will be displayed in the viewfinder.



3 Frame a photograph, focus, and shoot.

The camera takes two exposures when the shutter-release button is pressed all the way down. “**Jab Hdr**” will flash in the viewfinder while the images are combined; no photographs can be taken until recording is complete. HDR turns off automatically after the photograph is taken; to turn off HDR before shooting, rotate the mode dial to a setting other than **P**, **S**, **A**, or **M**.



Framing HDR Photographs

The edges of the image may be cropped out. The desired results may not be achieved if the camera or subject move during shooting. Depending on the scene, the effect may not be visible, shadows may appear around bright objects, or halos may appear around dark objects. Uneven shading may be visible with some subjects.

Multiple Exposure

Follow the steps below to record a series of two or three exposures in a single photograph. Multiple exposures produce colors noticeably superior to those in software-generated photographic overlays created from existing images.

■ Creating a Multiple Exposure

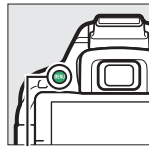
Multiple exposures can not be recorded in live view. Exit live view before proceeding.

Extended Recording Times

For an interval between exposures of more than 30 s, extend the meter-off delay using Custom Setting c2 (**Auto off timers**) > **Standby timer** (📖 186). The maximum interval between exposures is 30 s longer than the option selected for Custom Setting c2. Shooting will end automatically if no operations are performed for a set period and a multiple exposure will be created from the exposures that have been recorded to that point.

1 Select Multiple exposure.

Press the MENU button to display the menus. Highlight **Multiple exposure** in the shooting menu and press ►.

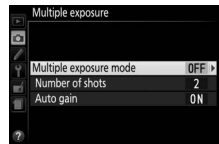


MENU button

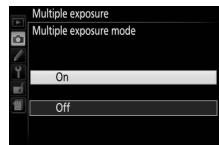


2 Enable multiple exposure mode.

Highlight **Multiple exposure mode** and press ►.

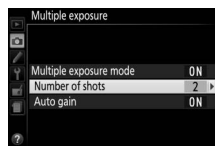


The options shown at right will be displayed. Highlight **On** and press **OK**.

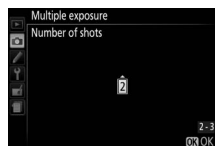


3 Choose the number of shots.

Highlight **Number of shots** and press ►.

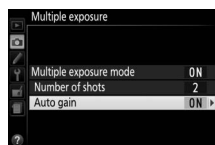


The dialog shown at right will be displayed. Press ▲ or ▼ to choose the number of exposures that will be combined to form a single photograph and press **OK**.



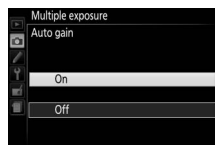
4 Choose the amount of gain.

Highlight **Auto gain** and press ►.



The following options will be displayed. Highlight an option and press **OK**.

- **On:** Gain is adjusted according to number of exposures actually recorded (gain for each exposure is set to $1/2$ for two exposures, $1/3$ for three exposures).
- **Off:** Gain is not adjusted when recording multiple exposure. Recommended if background is dark.



5 Frame a photograph, focus, and shoot.

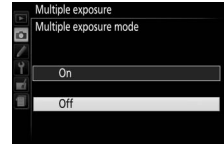
In single-frame release mode, one photograph will be taken each time the shutter-release button is pressed; continue shooting until all exposures have been recorded. In continuous high-speed and continuous low-speed release modes (46), the camera records all exposures in a single burst; shooting will pause after each multiple exposure.




■ Interrupting Multiple Exposures

To interrupt a multiple exposure before the specified number of exposures have been taken, select **Off** for **Multiple exposure** > **Multiple exposure mode** in the shooting menu. A multiple exposure will be created from the exposures that have been recorded to that point. If **Auto gain** is on, gain will be adjusted to reflect the number of exposures actually recorded. Note that shooting will end automatically if:

- The mode dial is rotated to a setting other than **P**, **S**, **A**, or **M**
- A two-button reset is performed (☰ 72)
- The camera is turned off
- The battery is exhausted
- One of the exposures is deleted



The Multiple Exposure Indicator

A  icon appears in the information display when multiple exposure shooting is enabled. The icon flashes while shooting is in progress.









Multiple Exposures

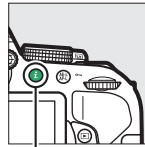
The information listed in the playback photo information display (including metering, exposure, shooting mode, focal length, date of recording and camera orientation) is for the first shot in the multiple exposure.

White Balance

White balance ensures that colors are unaffected by the color of the light source. Auto white balance is recommended for most light sources; other values can be selected if necessary according to the type of source:

Option	Description
AUTO Auto	Automatic white balance adjustment. Recommended in most situations.
 Incandescent	Use under incandescent lighting.
 Fluorescent	Use with the light sources listed on page 102.
 Direct sunlight	Use with subjects lit by direct sunlight.
 Flash	Use with the flash.
 Cloudy	Use in daylight under overcast skies.
 Shade	Use in daylight with subjects in the shade.
PRE Preset manual	Measure white balance or copy white balance from existing photo (104).

- 1 Display white balance options.**
Press the **i** button, then highlight the current white balance setting in the information display and press **OK**.



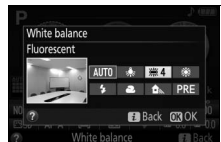
i button



Information display

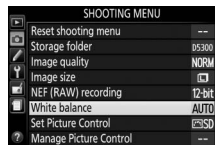



- 2 Choose a white balance option.**
Highlight an option and press **OK**.

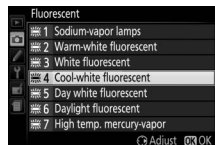


The Shooting Menu

White balance can be selected using the **White balance** option in the shooting menu (☐ 177), which also can be used to fine-tune white balance (☐ 103) or measure a value for preset white balance (☐ 104).















The  **Fluorescent** option in the **White balance** menu can be used to select the light source from the bulb types shown at right.



Color Temperature

The perceived color of a light source varies with the viewer and other conditions. Color temperature is an objective measure of the color of a light source, defined with reference to the temperature to which an object would have to be heated to radiate light in the same wavelengths. While light sources with a color temperature in the neighborhood of 5000–5500 K appear white, light sources with a lower color temperature, such as incandescent light bulbs, appear slightly yellow or red. Light sources with a higher color temperature appear tinged with blue. The camera white balance options are adapted to the following color temperatures (all figures are approximate):

-  (sodium-vapor lamps): **2700 K**
-  (incandescent)/
•  (warm-white fluorescent): **3000 K**
-  (white fluorescent): **3700 K**
-  (cool-white fluorescent): **4200 K**
-  (day white fluorescent): **5000 K**
-  (direct sunlight): **5200 K**
-  (flash): **5400 K**
-  (cloudy): **6000 K**
-  (daylight fluorescent): **6500 K**
-  (high temp. mercury-vapor): **7200 K**
-  (shade): **8000 K**

Bracketing

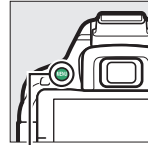
For information on automatically varying white balance settings over a series of shots, see page 108.

Fine-Tuning White Balance

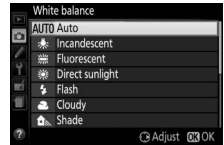
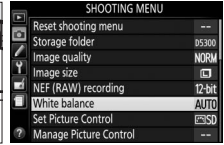
White balance can be “fine-tuned” to compensate for variations in the color of the light source or to introduce a deliberate color cast into an image. White balance is fine-tuned using the **White balance** option in the shooting menu.

- 1 Select a white balance option.**

Press **MENU** to display the menus, then highlight **White balance** in the shooting menu and press **▶**. Highlight the desired white balance option and press **▶** (if **Fluorescent** is selected, highlight the desired lighting type and press **▶**; note that fine-tuning is not available with **Preset manual**).





MENU button

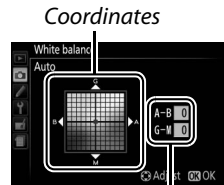
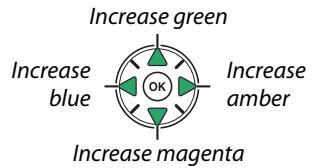


- 2 Fine-tune white balance.**

Use the multi selector to fine-tune white balance.

 **White Balance Fine-Tuning**

The colors on the fine-tuning axes are relative, not absolute. For example, moving the cursor to **B** (blue) when a “warm” setting such as  (incandescent) is selected will make photographs slightly “colder” but will not actually make them blue.



Adjustment

- 3 Save changes and exit.**

Press **OK**.



Preset Manual

Preset manual is used to record and recall custom white balance settings for shooting under mixed lighting or to compensate for light sources with a strong color cast. Two methods are available for setting preset white balance:

Method	Description
Measure	Neutral gray or white object is placed under lighting that will be used in final photo and white balance measured by camera (see below).
Use photo	White balance is copied from photo on memory card (107).

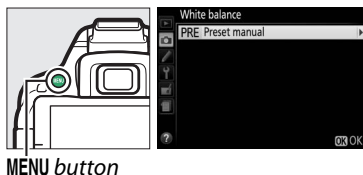
■ ■ Measuring a Value for Preset White Balance

1 Light a reference object.

Place a neutral gray or white object under the lighting that will be used in the final photograph.

2 Display white balance options.

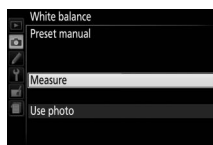
To display the menus, press the MENU button. Highlight **White balance** in the shooting menu and press ► to display white balance options. Highlight **Preset manual** and press ►.



MENU button

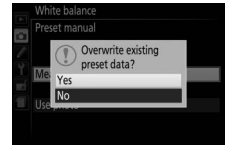
3 Select Measure.

Highlight **Measure** and press ►.

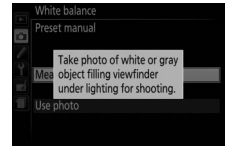


4 Select Yes.

The menu shown at right will be displayed; highlight **Yes** and press **OK**.



The camera will enter preset measurement mode.



When the camera is ready to measure white balance, a flashing **P** **⊗** **⊗** **⊗** (**PRE**) will appear in the viewfinder and information display.



5 Measure white balance.

Before the indicators stop flashing, frame the reference object so that it fills the viewfinder and press the shutter-release button all the way down. No photograph will be recorded; white balance can be measured accurately even when the camera is not in focus.



6 Check the results.

If the camera was able to measure a value for white balance, the message shown at right will be displayed and **Wd** will flash in the viewfinder for about eight seconds before the camera returns to shooting mode. To return to shooting mode immediately, press the shutter-release button halfway.



If lighting is too dark or too bright, the camera may be unable to measure white balance. A message will appear in the information display and a flashing **no Wd** will appear in the viewfinder for about eight seconds. Return to Step 5 and measure white balance again.



✓ Measuring Preset White Balance

If no operations are performed while the displays are flashing, direct measurement mode will end in the time selected for Custom Setting c2 (**Auto off timers**; □ 186). The default setting is eight seconds.

✓ Preset White Balance

The camera can store only one value for preset white balance at a time; the existing value will be replaced when a new value is measured. Note that exposure is automatically increased by 1 EV when measuring white balance; when shooting in mode **M**, adjust exposure so that the exposure indicator shows ± 0 (□ 87).

✍ Other Methods for Measuring Preset White Balance

To enter preset measurement mode (see above) after selecting preset white balance in the information display (□ 101), press **OK** for a few seconds. If white balance has been assigned to the **Fn** button (□ 193), white balance preset measurement mode can be activated by keeping the **Fn** button pressed for a few seconds after selecting preset white balance with the **Fn** button and command dial.

✍ Gray Panels

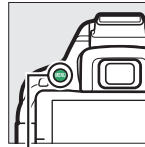
For more precise results, measure white balance using a standard gray panel.

■ Copying White Balance from a Photograph

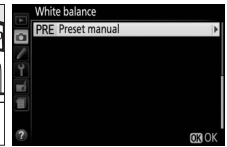
Follow the steps below to copy a value for white balance from a photograph on the memory card.

1 Select Preset manual.

To display the menus, press the **MENU** button. Highlight **White balance** in the shooting menu and press **▶** to display white balance options. Highlight **Preset manual** and press **▶**.

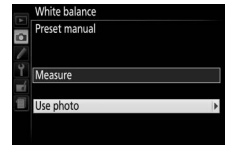


MENU button



2 Select Use photo.

Highlight **Use photo** and press **▶**.



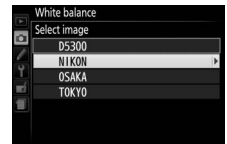
3 Choose Select image.

Highlight **Select image** and press **▶** (to skip the remaining steps and use the image last selected for preset white balance, select **This image**).



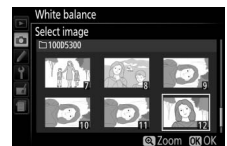
4 Choose a folder.

Highlight the folder containing the source image and press **▶**.



5 Highlight the source image.

To view the highlighted image full frame, press and hold the **Q** button.




6 Copy white balance.

Press **OK** to set preset white balance to the white balance value for the highlighted photograph.



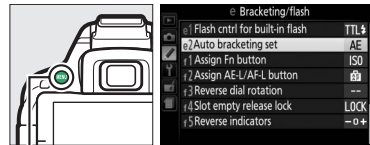
Bracketing

Bracketing automatically varies exposure, white balance, or Active D-Lighting (ADL) settings slightly with each shot, “bracketing” the current value. Choose in situations in which it is difficult to set exposure or white balance and there is not time to check results and adjust settings with each shot, or to experiment with different settings for the same subject.

Option	Description
AE AE bracketing	Vary exposure over a series of three photographs.  <p><i>Shot 1: unmodified</i> <i>Shot 2: exposure reduced</i> <i>Shot 3: exposure increased</i></p>
WB WB bracketing	Each time the shutter is released, the camera creates three images, each with a different white balance. Not available with image qualities of NEF (RAW).
ADL ADL bracketing	Take one photo with Active D-Lighting off, and another at the current Active D-Lighting setting.

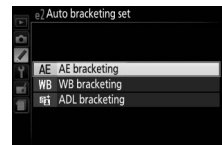
1 Choose a bracketing option.

After pressing **MENU** to display the menus, highlight Custom Setting e2 (**Auto bracketing set**) and press **▶**.



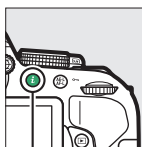
MENU button

Highlight the desired bracketing type and press **OK**.



2 Display bracketing options.

Press the **i** button, then highlight the current bracketing setting and press **OK**.



i button

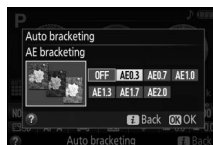


Information display



3 Select a bracketing increment.

Highlight a bracketing increment and press **OK**. Choose from values between 0.3 and 2 EV (AE bracketing) or 1 to 3 (WB bracketing), or select **ADL** (ADL bracketing).



4 Frame a photograph, focus, and shoot.

AE bracketing: The camera will vary exposure with each shot. The first shot will be taken at the value currently selected for exposure compensation. The bracketing increment will be subtracted from the current value in the second shot and added in the third shot, “bracketing” the current value. The modified values are reflected in the values shown for shutter speed and aperture.

WB bracketing: Each shot is processed to create three copies, one at the current white balance setting, one with increased amber, and one with increased blue.

ADL bracketing: The first shot after bracketing is activated is taken with Active D-Lighting off, the second at the current Active D-Lighting setting (□ 94; if Active D-Lighting is off, the second shot will be taken with Active D-Lighting set to **Auto**).

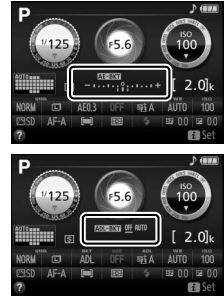


In continuous high-speed and continuous low-speed release modes, shooting will pause after each bracketing cycle. If the camera is turned off before all shots in the bracketing sequence have been taken, bracketing will resume from the next shot in the sequence when the camera is turned on.

The Bracketing Progress Indicator

During AE bracketing, a bar is removed from the bracketing progress indicator with each shot (-, 0, + > -, 0, + > -, 0, +).

During ADL bracketing, the setting that will be used for the next shot is underlined in the information display.



Disabling Bracketing

To disable bracketing and resume normal shooting, select **OFF** in Step 3 on the previous page. To cancel bracketing before all frames have been recorded, rotate the mode dial to a setting other than **P**, **S**, **A**, or **M**.

Exposure Bracketing







The camera modifies exposure by varying shutter speed and aperture (mode **P**), aperture (mode **S**), or shutter speed (modes **A** and **M**). If auto ISO sensitivity control is enabled, the camera will automatically vary ISO sensitivity for optimum exposure when the limits of the camera exposure system are exceeded.

Picture Controls

Nikon's unique Picture Control system makes it possible to share image processing settings, including sharpening, contrast, brightness, saturation, and hue, among compatible devices and software.

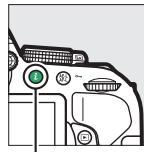
Selecting a Picture Control

Choose a Picture Control according to the subject or type of scene.

Option	Description
 Standard	Recommended for most situations, this option uses standard processing for balanced results.
 Neutral	A good choice for photographs that will later be extensively processed or retouched, this option uses minimal processing for natural results.
 Vivid	Choose this option for photographs that emphasize primary colors. Pictures are enhanced for a vivid, photoprint effect.
 Monochrome	Take monochrome photographs.
 Portrait	Process portraits for skin with natural texture and a rounded feel.
 Landscape	Produces vibrant landscapes and cityscapes.

1 Display Picture Control options.

Press the **i** button, then highlight the current Picture Control and press **OK**.



i button



Information display



2 Select a Picture Control.

Highlight a Picture Control and press **OK**.



Modifying Picture Controls

Existing preset or custom Picture Controls (☐ 115) can be modified to suit the scene or the user's creative intent. Choose a balanced combination of settings using **Quick adjust**, or make manual adjustments to individual settings.

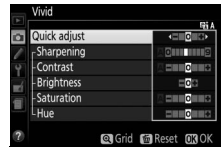
1 Select a Picture Control.

Press **MENU** to display the menus, then highlight **Set Picture Control** in the shooting menu and press **▶**. Highlight the desired Picture Control and press **▶**.



2 Adjust settings.

Press **▲** or **▼** to highlight the desired setting and press **◀** or **▶** to choose a value (☐ 113). Repeat this step until all settings have been adjusted, or select **Quick adjust** to choose a preset combination of settings. Default settings can be restored by pressing the **⌂** button.

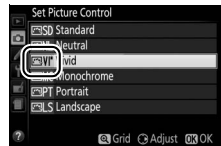


3 Save changes and exit.

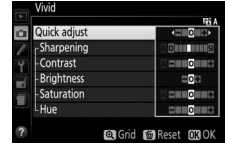
Press **OK**.



Picture Controls that have been modified from default settings are indicated by an asterisk ("*").



Picture Control Settings



Option	Description	
Quick adjust	Mute or heighten the effect of the selected Picture Control (note that this resets all manual adjustments). Not available with Neutral , Monochrome , or custom Picture Controls.	
Manual adjustments (all Picture Controls)	Sharpening	Control the sharpness of outlines. Select A to adjust sharpening automatically according to the type of scene.
	Contrast	Adjust contrast manually or select A to let the camera adjust contrast automatically.
	Brightness	Raise or lower brightness without loss of detail in highlights or shadows.
Manual adjustments (non-monochrome only)	Saturation	Control the vividness of colors. Select A to adjust saturation automatically according to the type of scene.
	Hue	Adjust hue.
Manual adjustments (monochrome only)	Filter effects	Simulate the effect of color filters on monochrome photographs (☞ 114).
	Toning	Choose the tint used in monochrome photographs (☞ 114).


✔ "A" (Auto)

Results for auto sharpening, contrast, and saturation vary with exposure and the position of the subject in the frame.

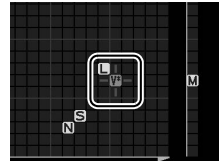
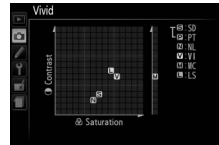
✍ Custom Picture Controls

Custom Picture Controls are created through modifications to existing Picture Controls using the **Manage Picture Control** option in the shooting menu (☞ 115) and can be saved to a memory card for sharing among other cameras of the same model and compatible software (☞ 117).

The Picture Control Grid

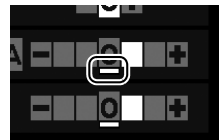
To display a grid showing saturation (non-monochrome controls only) and contrast for the Picture Control selected in Step 2, press and hold the  button.

The icons for Picture Controls that use auto contrast and saturation are displayed in green in the Picture Control grid, and lines appear parallel to the axes of the grid.



Previous Settings

The line under the value display in the Picture Control setting menu indicates the previous value for the setting.



Custom Picture Controls

The options available with custom picture controls are the same as those on which the custom picture control was based.




Filter Effects (Monochrome Only)

The options in this menu simulate the effect of color filters on monochrome photographs. The following filter effects are available:

Option	Description
Y Yellow	Enhances contrast. Can be used to tone down the brightness of the sky in landscape photographs. Orange produces more contrast than yellow, red more contrast than orange.
O Orange	
R Red	
G Green	Softens skin tones. Can be used for portraits.

Note that the effects achieved with **Filter effects** are more pronounced than those produced by physical glass filters.

Toning (Monochrome Only)

Choose from **B&W** (black-and-white), **Sepia**, **Cyanotype** (blue-tinted monochrome), **Red**, **Yellow**, **Green**, **Blue Green**, **Blue**, **Purple Blue**, **Red Purple**. Pressing  when **Toning** is selected displays saturation options. Press  or  to adjust saturation. Saturation control is not available when **B&W** (black-and-white) is selected.

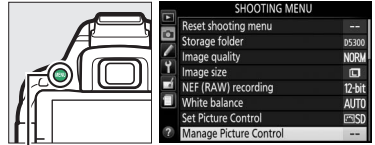


Creating Custom Picture Controls

The Picture Controls supplied with the camera can be modified and saved as custom Picture Controls.

1 Select Manage Picture Control.

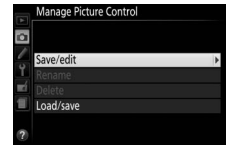
To display the menus, press the MENU button. Highlight **Manage Picture Control** in the shooting menu and press ►.



MENU button

2 Select Save/edit.

Highlight **Save/edit** and press ►.




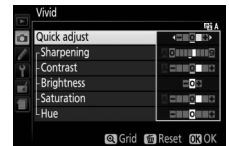
3 Select a Picture Control.

Highlight an existing Picture Control and press ►, or press OK to proceed to step 5 to save a copy of the highlighted Picture Control without further modification.



4 Edit the selected Picture Control.

See page 113 for more information. To abandon any changes and start over from default settings, press the  button. Press OK when settings are complete.



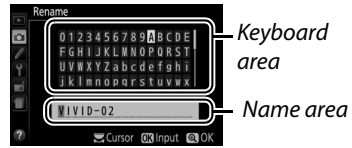
5 Select a destination.

Highlight a destination for the custom Picture Control (C-1 through C-9) and press ►.



6 Name the Picture Control.

By default, new Picture Controls are named by adding a two-digit number (assigned automatically) to the name of the existing Picture Control; to use the default name, proceed to Step 7. To move the cursor in the name area, rotate the command dial. To enter a letter, use the multi selector to highlight the desired character in the keyboard area and press **OK**. To delete the character at the current cursor position, press the **⌫** button.



Custom Picture Control names can be up to nineteen characters long. Any characters after the nineteenth will be deleted.

7 Save changes and exit.

Press **Q** to save changes and exit. The new Picture Control will appear in the Picture Control list.



Manage Picture Control > Rename

Custom Picture Controls can be renamed at any time using the **Rename** option in the **Manage Picture Control** menu.

Manage Picture Control > Delete

The **Delete** option in the **Manage Picture Control** menu can be used to delete selected custom Picture Controls when they are no longer needed.

The Original Picture Control Icon

The original preset Picture Control on which the custom Picture Control is based is indicated by an icon in the top right corner of the edit display.

Original Picture Control icon

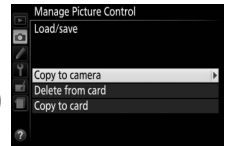
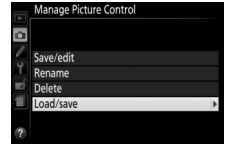


Sharing Custom Picture Controls

Custom Picture Controls created using the Picture Control Utility available with ViewNX 2 or optional software such as Capture NX 2 can be copied to a memory card and loaded into the camera, or custom Picture Controls created with the camera can be copied to the memory card to be used in compatible cameras and software and then deleted when no longer needed.

To copy custom Picture Controls to or from the memory card, or to delete custom Picture Controls from the memory card, highlight **Load/Save** in the **Manage Picture Control** menu and press ►. The following options will be displayed:

- **Copy to camera:** Copy custom Picture Controls from the memory card to custom Picture Controls C-1 through C-9 on the camera and name them as desired.
- **Delete from card:** Delete selected custom Picture Controls from the memory card.
- **Copy to card:** Copy a custom Picture Control (C-1 through C-9) from the camera to a selected destination (1 through 99) on the memory card.



Saving Custom Picture Controls

Up to 99 custom Picture Controls can be stored on the memory card at any one time. The memory card can only be used to store user-created custom Picture Controls. The preset Picture Controls supplied with the camera can not be copied to the memory card, renamed, or deleted.

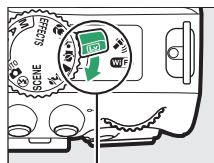
Live View

Framing Photographs in the Monitor

Follow the steps below to take photographs in live view.

1 Rotate the live view switch.

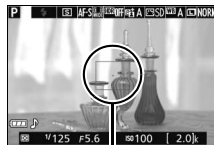
The view through the lens will be displayed in the monitor.



Live view switch

2 Position the focus point.

Position the focus point over your subject as described on page 121.



Focus point

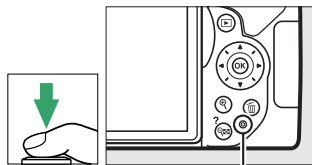
3 Focus.

Press the shutter-release button halfway. The focus point will flash green while the camera focuses. If the camera is able to focus, the focus point will be displayed in green; if the camera is unable to focus, the focus point will flash red (note that pictures can be taken even when the focus point flashes red; check focus in the monitor before shooting). Except in **AUTO** and **AE-L/AF-L** (**OK**) modes, exposure can be locked by pressing the



4 Take the picture.

Press the shutter-release button the rest of the way down. The monitor turns off and the memory card access lamp lights during recording. *Do not remove the battery or memory card until recording is complete.* When shooting is complete, the photograph will be displayed in the monitor for a few seconds before the camera returns to live view mode. To exit, rotate the live view switch.







Memory card access lamp

Focusing in Live View

Follow the steps below to choose focus and AF-area modes and position the focus point.

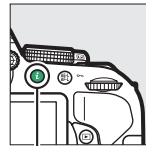
■ ■ Choosing How the Camera Focuses (Focus Mode)

The following focus modes are available in live view (note that full-time-servo AF is not available in , , and  modes):

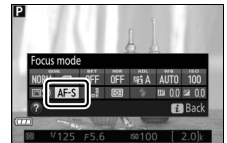
Option	Description
AF-S Single-servo AF	For stationary subjects. Focus locks when shutter-release button is pressed halfway.
AF-F Full-time-servo AF	For moving subjects. Camera focuses continuously until shutter-release button is pressed halfway. Focus locks when shutter-release button is pressed halfway.
MF Manual focus	Focus manually ( 125).

1 Display focus options.

Press the **i** button, then highlight the current focus mode in the information display and press **OK**.



i button














2 Choose a focus option.

Highlight an option and press **OK**.



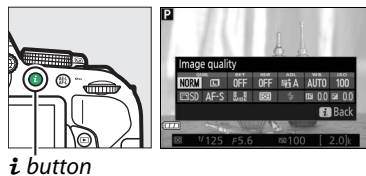
■ Choosing How the Camera Picks the Area (AF-Area Mode)

In modes other than , , and , the following AF-area modes can be selected in live view (note that subject-tracking AF is not available in , , , and  modes):

Option	Description
 Face-priority AF	Use for portraits. The camera automatically detects and focuses on portrait subjects.
 Wide-area AF	Use for hand-held shots of landscapes and other non-portrait subjects. Use the multi selector to select the focus point.
 Normal-area AF	Use for pin-point focus on a selected spot in the frame. A tripod is recommended.
 Subject-tracking AF	Use if you want focus to track a selected subject.

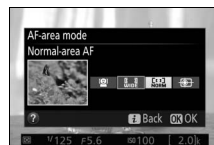
1 Display AF-area modes.

Press the **i** button, then highlight the current AF-area mode in the information display and press **OK**.




2 Choose an AF-area mode.

Highlight an option and press **OK**.





3 Choose the focus point.

 (**face-priority AF**): A double yellow border will be displayed when the camera detects a portrait subject (if multiple faces, up to a maximum of 35, are detected, the camera will focus on the closest subject; to choose a different subject, use the multi selector). If the camera can no longer detect the subject (because, for example, the subject has turned to face away from the camera), the border will no longer be displayed.






Focus point

 (**wide- and normal-area AF**): Use the multi selector to move the focus point anywhere in the frame, or press  to position the focus point in the center of the frame.



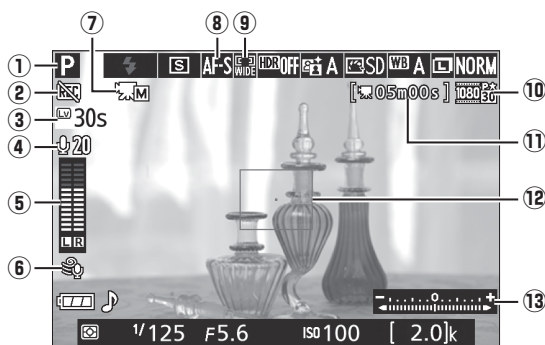
Focus point

 (**subject-tracking AF**): Position the focus point over your subject and press . The focus point will track the selected subject as it moves through the frame. To end focus tracking, press  a second time.



Focus point

The Live View Display

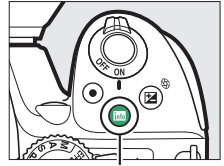


Item	Description	
① Shooting mode	The mode currently selected with the mode dial.	19, 30, 37, 82
② "No movie" icon	Indicates that movies can not be recorded.	—
③ Time remaining	The amount of time remaining before live view ends automatically. Displayed if shooting will end in 30 s or less.	124, 129
④ Microphone sensitivity	Microphone sensitivity for movie recording.	128
⑤ Sound level	Sound level for audio recording. Displayed in red if level is too high; adjust microphone sensitivity accordingly.	128
⑥ Wind noise reduction	Displayed when On is selected for Movie settings > Wind noise reduction in the shooting menu.	128
⑦ Manual movie settings indicator	Displayed when On is selected for Manual movie settings in mode M .	129
⑧ Focus mode	The current focus mode.	119
⑨ AF-area mode	The current AF-area mode.	120
⑩ Movie frame size	The frame size of movies recorded in movie mode.	128
⑪ Time remaining (movie mode)	The recording time remaining in movie mode.	126
⑫ Focus point	The current focus point. The display varies with the option selected for AF-area mode (□ 120).	121
⑬ Exposure indicator	Indicates whether the photograph would be under- or over-exposed at current settings (mode M only).	87

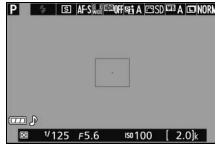
Note: Display shown with all indicators lit for illustrative purposes.

Live View/Movie Recording Display Options

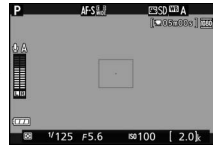
Press the **info** button to cycle through display options as shown below. Circled areas indicate edges of movie frame crop.




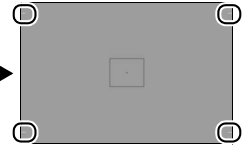
info button



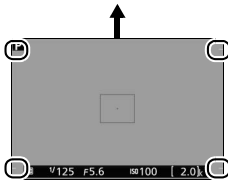
Show detailed photo indicators



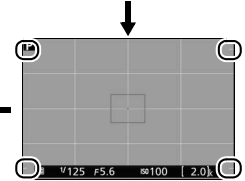
Show movie indicators
( 128) *




Hide indicators*


















Show basic photo indicators*

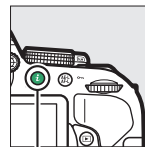


Framing grid*

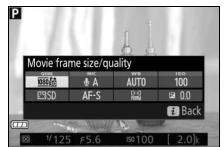
* A crop showing the area recorded is displayed during movie recording when frame sizes other than 640 × 424 are selected for **Movie settings > Frame size/frame rate** in the shooting menu ( 128; the area outside the movie frame crop is grayed out when movie indicators are displayed).

Camera Settings

Except when movie indicators are displayed, you can access the following live view photography settings by pressing the **i** button: image quality ( 59), image size ( 61), bracketing increment ( 109), HDR ( 96), Active D-Lighting ( 94), white balance ( 101), ISO sensitivity ( 67), Picture Controls ( 111), focus mode ( 119), AF-area mode ( 120), metering ( 90), flash mode ( 63, 65), flash compensation ( 93), and exposure compensation ( 92). When movie indicators are displayed, movie settings can be adjusted ( 122).



i button



Exposure

Depending on the scene, exposure may differ from that which would be obtained when live view is not used. Metering in live view is adjusted to suit the live view display, producing photographs with exposure close to what is seen in the monitor (note that exposure compensation can only be previewed in the monitor at values between +3 EV and -3 EV). To prevent light entering via the viewfinder from interfering with exposure, remove the rubber eyecup and cover the viewfinder with the supplied eyepiece cap before shooting (□ 50).

HDMI

When the camera is attached to an HDMI video device, the camera monitor will remain on and the video device will display the view through the lens. If the device supports HDMI-CEC, select **Off** for the **HDMI > Device control** option in the setup menu (□ 166) before shooting in live view.

Shooting in Live View Mode

Although they will not appear in the final picture, distortion may be visible in the monitor if the camera is panned horizontally or an object moves at high speed through frame. Bright light sources may leave after-images in the monitor when the camera is panned. Bright spots may also appear. Flicker and banding visible in the monitor under fluorescent, mercury vapor, or sodium lamps can be reduced using **Flicker reduction** (□ 200), although they may still be visible in the final photograph at some shutter speeds. When shooting in live view mode, avoid pointing the camera at the sun or other strong light sources. Failure to observe this precaution could result in damage to the camera's internal circuitry.

Live view ends automatically when the monitor is closed (closing the monitor does not end live view on televisions or other external displays).

Live view may end automatically to prevent damage to the camera's internal circuits; exit live view when the camera is not in use. Note that the temperature of the camera's internal circuits may rise and noise (bright spots, randomly-spaced bright pixels, or fog) may be displayed in the following instances (the camera may also become noticeably warm, but this does not indicate a malfunction):

- The ambient temperature is high
- The camera has been used for extended periods in live view or to record movies
- The camera has been used in continuous release mode for extended periods

If live view does not start when you attempt to start live view, wait for the internal circuits to cool and then try again.

The Count Down Display

A count down will be displayed 30 s before live view ends automatically (□ 122; the timer turns red 5 s before the auto off timer expires (□ 186) or if live view is about to end to protect the internal circuits). Depending on shooting conditions, the timer may appear immediately when live view is selected.

✔ Using Autofocus in Live View

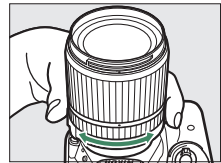
Autofocus is slower in live view and the monitor may brighten or darken while the camera focuses. The camera may be unable to focus in the situations listed below (note that the focus point may sometimes be displayed in green when the camera is unable to focus):





- The subject contains lines parallel to the long edge of the frame
- The subject lacks contrast
- The subject in the focus point contains areas of sharply contrasting brightness, or the subject is lit by spot lighting or by a neon sign or other light source that changes in brightness
- Flicker or banding appears under fluorescent, mercury-vapor, sodium-vapor, or similar lighting
- A cross (star) filter or other special filter is used
- The subject appears smaller than the focus point
- The subject is dominated by regular geometric patterns (e.g., blinds or a row of windows in a skyscraper)
- The subject is moving

In addition, the subject-tracking AF may be unable to track subjects if they move quickly, leave the frame or are obscured by other objects, change visibly in size, color, or brightness, or are too small, too large, too bright, too dark, or similar in color or brightness to the background.

✎ Manual Focus

To focus in manual focus mode (M 57), rotate the lens focus ring until the subject is in focus.



To magnify the view in the monitor up to about 8.3× for precise focus, press the  button. While the view through the lens is zoomed in, a navigation window will appear in a gray frame at the bottom right corner of the display. Use the multi selector to scroll to areas of the frame not visible in the monitor (available only if  **(Wide-area AF)** or  **(Normal-area AF)** is selected for **AF-area mode**), or press  (?) to zoom out.



Q button



Navigation window

Recording and Viewing Movies


Recording Movies

Movies can be recorded in live view mode.

1 Rotate the live view switch.

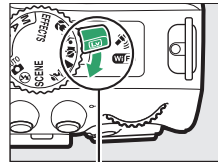
The view through the lens will be displayed in the monitor.

✓ The Icon

A  icon (□ 122) indicates that movies can not be recorded.

✓ Before Recording

Set aperture before recording in mode **A** or **M** (□ 86, 87).









Live view switch

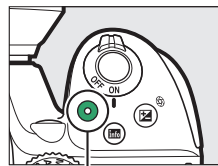
2 Focus.

Frame the opening shot and focus as described in Steps 2 and 3 of “Framing Photographs in the Monitor” (□ 118; see also “Focusing in Live View” on pages □ 119–121). Note that the number of subjects that can be detected in face-priority AF drops during movie recording.



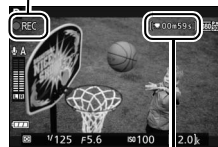
3 Start recording.

Press the movie-record button to start recording. A recording indicator and the time available are displayed in the monitor. Except in  and  modes, exposure can be locked by pressing the  button (□ 91) or (in modes **P**, **S**, **A**, and ) altered by up to ± 3 EV in steps of $1/3$ EV by pressing the  () button and rotating the command dial (□ 92; note that depending on the brightness of the subject, changes to exposure may have no visible effect).



Movie-record button

Recording indicator



Time remaining

4 End recording.

Press the movie-record button again to end recording. Recording will end automatically when the maximum length is reached, the memory card is full, another mode is selected, or the monitor is closed (closing the monitor does not end recording on televisions or other external displays).

Taking Photographs During Movie Recording

To end movie recording, take a photograph, and exit to live view, press the shutter-release button all the way down and hold it in this position until the shutter is released.

Maximum Length

The maximum length for individual movie files is 4 GB (for maximum recording times, see page 128); note that depending on memory card write speed, shooting may end before this length is reached (□ 238).

Recording Movies

Flicker, banding, or distortion may be visible in the monitor and in the final movie under fluorescent, mercury vapor, or sodium lamps or if the camera is panned horizontally or an object moves at high speed through frame (flicker and banding can be reduced using **Flicker reduction**; □ 200). Bright light sources may leave after-images when the camera is panned. Jagged edges, color fringing, moiré, and bright spots may also appear. Bright bands may appear in some areas of the frame if the subject is briefly illuminated by a flash or other bright, momentary light source. When recording movies, avoid pointing the camera at the sun or other strong light sources. Failure to observe this precaution could result in damage to the camera's internal circuitry.

The camera can record both video and sound; do not cover the microphone during recording. Note that the built-in microphone may record lens noise during autofocus and vibration reduction.

Flash lighting can not be used during movie recording.

Live view may end automatically to prevent damage to the camera's internal circuits; exit live view when the camera is not in use. Note that the temperature of the camera's internal circuits may rise and noise (bright spots, randomly-spaced bright pixels, or fog) may be displayed in the following instances (the camera may also become noticeably warm, but this does not indicate a malfunction):

- The ambient temperature is high
- The camera has been used for extended periods in live view or to record movies
- The camera has been used in continuous release mode for extended periods

If live view does not start when you attempt to start live view or movie recording, wait for the internal circuits to cool and then try again.

Matrix metering is used regardless of the metering method selected. Shutter speed and ISO sensitivity are adjusted automatically unless **On** is selected for **Manual movie settings** (□ 129) and the camera is in mode **M**.

Movie Settings

The camera offers the following movie settings.

- **Frame size/frame rate, Movie quality:** Choose from the following options. The frame rate depends on the option currently selected for **Video mode** in the setup menu (☐ 202):

	Frame size/frame rate		Maximum length (high movie quality ★/ normal movie quality) ⁴
	Frame size (pixels)	Frame rate ¹	
	1920 × 1080	60p ²	10 min./20 min.
		50p ³	
		30p ²	20 min./29 min. 59 s
		25p ³	
		24p	
	1280 × 720	60p ²	
		50p ³	
	640 × 424	30p ²	29 min. 59 s /
		25p ³	29 min. 59 s

1 Listed value. Actual frame rates for 60p, 50p, 30p, 25p, and 24p are 59.94, 50, 29.97, 25, and 23.976 fps respectively.

2 Available when **NTSC** is selected for **Video mode** (☐ 202).

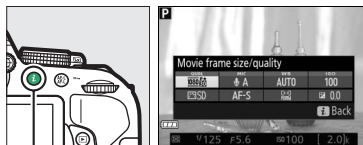
3 Available when **PAL** is selected for **Video mode**.

4 Movies recorded in miniature effect mode are up to three minutes long when played back.

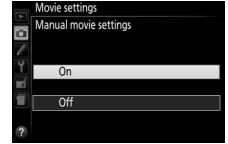
- **Microphone:** Turn the built-in or optional ME-1 stereo microphones (☐ 129, 237) on or off or adjust microphone sensitivity. Choose **Auto sensitivity** to adjust sensitivity automatically, **Microphone off** to turn sound recording off; to select microphone sensitivity manually, select **Manual sensitivity** and choose a sensitivity.
- **Wind noise reduction:** Select **On** to enable the low-cut filter for the built-in microphone (optional stereo microphones are unaffected; ☐ 129, 237), reducing noise produced by wind blowing over the microphone (note that other sounds may also be affected).

The Live View Display

The movie crop can be viewed during live view by pressing the button to select the “show movie indicators”, “hide indicators”, “framing grid”, or “show basic photo indicators” display (☐ 123). When movie indicators are displayed, you can access the following movie settings by pressing the button: movie frame size/quality, microphone sensitivity, white balance (☐ 101), ISO sensitivity (☐ 67), Picture Controls (☐ 111), focus mode (☐ 119), AF-area mode (☐ 120), and exposure compensation (☐ 92).

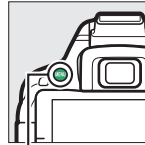


- **Manual movie settings:** Choose **On** to allow manual adjustments to shutter speed and ISO sensitivity when the camera is in mode **M**. Shutter speed can be set to values as fast as $\frac{1}{4000}$ s; the slowest speed available varies with the frame rate: $\frac{1}{30}$ s for frame rates of 24p, 25p, and 30p, $\frac{1}{50}$ s for 50p, and $\frac{1}{60}$ s for 60p. ISO sensitivity can be set to values between ISO 100 and Hi 1 (☐ 67). If shutter speed and ISO sensitivity are not in these ranges when live view starts, they will automatically be set to supported values, and remain at these values when live view ends. Note that ISO sensitivity is fixed at the value selected; the camera does not adjust ISO sensitivity automatically when **On** is selected for **ISO sensitivity settings > Auto ISO sensitivity control** in the shooting menu (☐ 180).

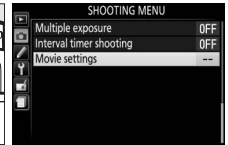


1 Select Movie settings.

Press the **MENU** button to display the menus. Highlight **Movie settings** in the shooting menu and press **▶**.

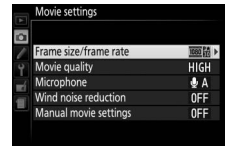


MENU button



2 Choose movie options.

Highlight the desired item and press **▶**, then highlight an option and press **OK**.



Using an External Microphone

The optional ME-1 stereo microphone can be used to reduce noise caused by lens vibration being recorded during autofocus.



The Count-Down Display

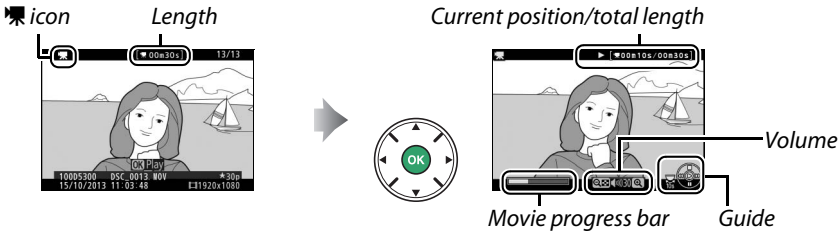
A count down will be displayed 30 s before live view ends automatically (☐ 122). Depending on shooting conditions, the timer may appear immediately when movie recording begins. Note that regardless of the amount of recording time available, live view will still end automatically when the timer expires. Wait for the internal circuits to cool before resuming movie recording.

HDMI and Other Video Devices














When the camera is attached to an HDMI video device, the camera monitor will remain on and the video device will display the view through the lens. If the device supports HDMI-CEC, select **Off** for the **HDMI > Device control** option in the setup menu (☐ 166) before shooting in live view.

Viewing Movies

Movies are indicated by a  icon in full-frame playback (135). Press  to start playback; your current position is indicated by the movie progress bar.





The following operations can be performed:

To	Use	Description
Pause		Pause playback.
Play		Resume playback when movie is paused or during rewind/advance.
Advance/ rewind		Speed increases with each press, from 2x to 4x to 8x to 16x; keep pressed to skip to beginning or end of movie (first frame is indicated by  in top right corner of monitor, last frame by ). If playback is paused, movie rewinds or advances one frame at a time; hold for continuous rewind or advance.
Skip 10 s		Rotate the command dial to skip ahead or back 10 s.
Adjust volume	 (?)	Press  to increase volume,  (?) to decrease.
Return to full-frame playback	 / 	Press  or  to exit to full-frame playback.

Editing Movies

Trim footage to create edited copies of movies or save selected frames as JPEG stills.

Option	Description
 Choose start/end point	Create a copy from which the opening or closing footage has been removed.
 Save selected frame	Save a selected frame as a JPEG still.

Trimming Movies

To create trimmed copies of movies:

1 Display a movie full frame.

2 Pause the movie on the new opening or closing frame.

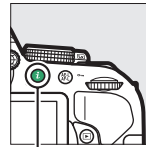
Play the movie back as described on page 130, pressing **OK** to start and resume playback and **▼** to pause. Pause playback when you reach the new opening or closing frame.



Movie progress bar

3 Select **Choose start/end point**.

Press the **i** button, then highlight **Choose start/end point** and press **▶**.

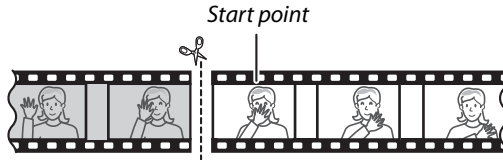
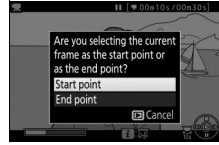


i button

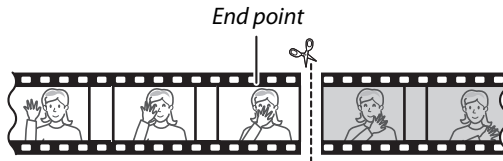


4 Choose the current frame as the new start or end point.

To create a copy that begins from the current frame, highlight **Start point** and press **OK**. The frames before the current frame will be removed when you save the copy.



To create a copy that ends at the current frame, highlight **End point** and press **OK**. The frames after the current frame will be removed when you save the copy.



5 Confirm the new start or end point.

If the desired frame is not currently displayed, press **◀** or **▶** to advance or rewind (to skip to 10 s ahead or back, rotate the command dial).



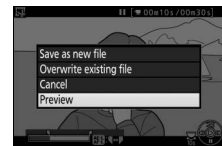
6 Create the copy.

Once the desired frame is displayed, press **▲**.



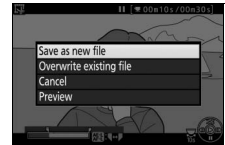
7 Preview the movie.

To preview the copy, highlight **Preview** and press **OK**. To abandon the current copy and return to Step 5, highlight **Cancel** and press **OK**; to save the copy, proceed to Step 8.



8 Save the copy.

Highlight **Save as new file** and press **OK** to save the copy to a new file. To replace the original movie file with the edited copy, highlight **Overwrite existing file** and press **OK**.



✓ Trimming Movies

Movies must be at least two seconds long. The copy will not be saved if there is insufficient space available on the memory card.

Copies have the same time and date of creation as the original.

✎ Choosing the Role of the Current Frame

To make the frame displayed in Step 5 the new end point (⏪) instead of the new start point (⏩) or vice versa, press the **AE-L/AF-L** (**⏪**) button.



AE-L/AF-L (**⏪**) button

Saving Selected Frames

To save a copy of a selected frame as a JPEG still:

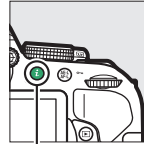
1 Pause the movie on the desired frame.

Play the movie back as described on page 130, pressing **OK** to start and resume playback and **▼** to pause. Pause the movie at the frame you intend to copy.

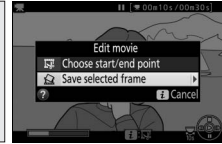


2 Choose Save selected frame.

Press the **i** button, then highlight **Save selected frame** and press **▶**.



i button



3 Create a still copy.

Press **▲** to create a still copy of the current frame.



4 Save the copy.

Highlight **Yes** and press **OK** to create a fine-quality (□ 59) JPEG copy of the selected frame.




Save Selected Frame

JPEG movie stills created with the **Save selected frame** option can not be retouched. JPEG movie stills lack some categories of photo information (□ 136).


















Playback and Deletion

Full-Frame Playback




To play photographs back, press the  button. The most recent photograph will be displayed in the monitor.

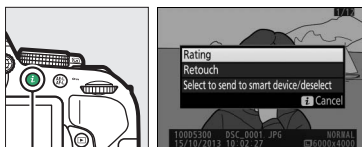


 button

To	Use	Description
View additional photographs		Press  to view photographs in order recorded,  to view photographs in reverse order.
View additional photo info		Change photo info displayed ( 136).
View thumbnails		See page 140 for more information on the thumbnail display.
		
Zoom in on photograph		See page 142 for more information on playback zoom.
Delete images		Confirmation dialog will be displayed. Press  again to delete photo.
Change protect status		To protect image, or to remove protection from protected image, press  button ( 143).
Play movie		If current picture is marked with  icon to show that it is a movie, pressing  starts movie playback ( 130).

The *i* Button

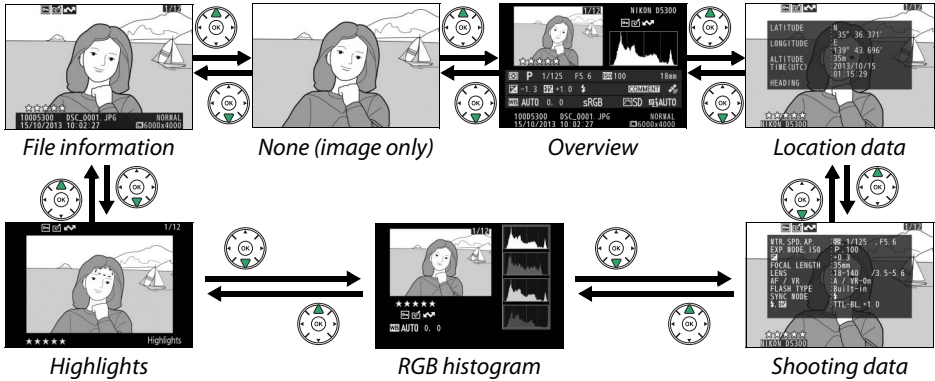
Pressing the *i* button in full-frame, thumbnail, or calendar playback displays the dialog shown at right, where you can rate pictures ( 144), retouch photos and edit movies ( 131, 205), and select pictures for transfer to a smart device ( 173).



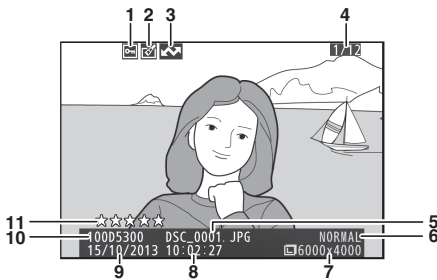
i button

Photo Information

Photo information is superimposed on images displayed in full-frame playback. Press ▲ or ▼ to cycle through photo information as shown below. Note that “image only”, shooting data, RGB histograms, highlights, and overview data are only displayed if corresponding option is selected for **Playback display options** (176). Location data are only displayed if location data were embedded in the picture when it was taken (74).

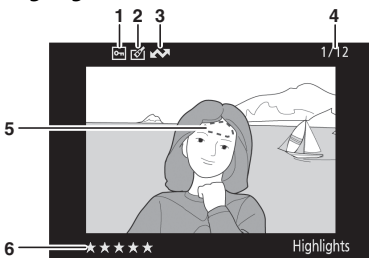


File Information



1	Protect status.....	143
2	Retouch indicator.....	206
3	Upload marking.....	173
4	Frame number/total number of images	
5	File name.....	189
6	Image quality.....	59
7	Image size.....	61
8	Time of recording.....	15, 201
9	Date of recording.....	15, 201
10	Folder name.....	178
11	Rating.....	144

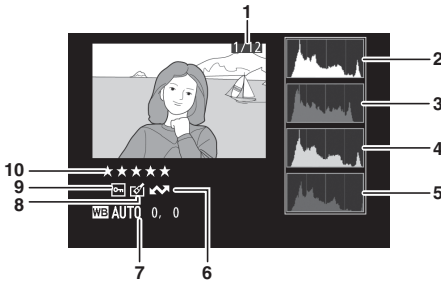
Highlights*



1	Protect status.....	143
2	Retouch indicator.....	206
3	Upload marking.....	173
4	Frame number/total number of images	
5	Image highlights	
6	Rating.....	144

* Flashing areas indicate highlights (areas that may be overexposed).

■ ■ RGB Histogram



1	Frame number/total number of images	
2	Histogram (RGB channel). In all histograms, horizontal axis gives pixel brightness, vertical axis number of pixels.	
3	Histogram (red channel)	
4	Histogram (green channel)	
5	Histogram (blue channel)	
6	Upload marking	173
7	White balance	101
	White balance fine-tuning	103
	Preset manual	104
8	Retouch indicator	206
9	Protect status	143
10	Rating.....	144

Playback Zoom

To zoom in on the photograph when the histogram is displayed, press \mathcal{R} . Use the \mathcal{R} and \mathcal{R} (?) buttons to zoom in and out and scroll the image with the multi selector. The histogram will be updated to show only the data for the portion of the image visible in the monitor.



Histograms

Camera histograms are intended as a guide only and may differ from those displayed in imaging applications. Some sample histograms are shown below:

If the image contains objects with a wide range of brightnesses, the distribution of tones will be relatively even.



If the image is dark, tone distribution will be shifted to the left.

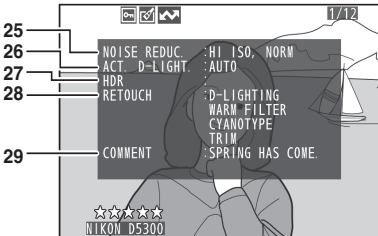
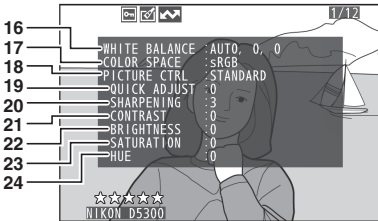
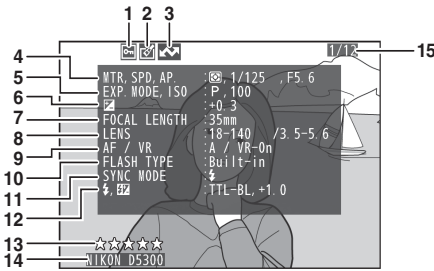


If the image is bright, tone distribution will be shifted to the right.



Increasing exposure compensation shifts the distribution of tones to the right, while decreasing exposure compensation shifts the distribution to the left. Histograms can provide a rough idea of overall exposure when bright ambient lighting makes it difficult to see photographs in the monitor.

Shooting Data

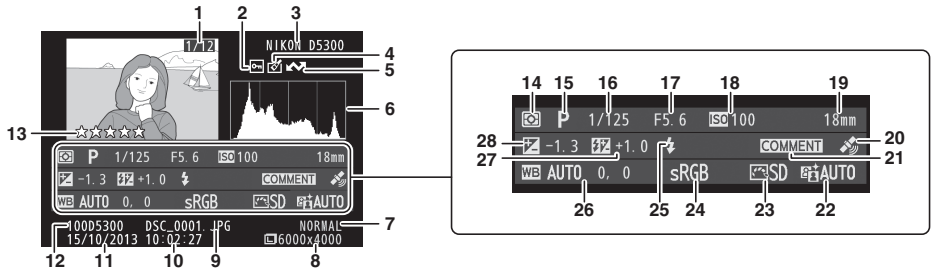


1	Protect status	143
2	Retouch indicator	206
3	Upload marking	173
4	Metering	90
	Shutter speed.....	83
	Aperture.....	83

5	Shooting mode	19, 30, 37, 82
	ISO sensitivity ¹	67
6	Exposure compensation	92
7	Focal length.....	231
8	Lens data	
9	Focus mode	51, 119
	Lens VR (vibration reduction) ²	18, 181
10	Flash type	192, 232
	Commander mode ²	
11	Flash mode	63, 65
12	Flash control.....	192
	Flash compensation	93
13	Rating.....	144
14	Camera name	
15	Frame number/total number of images	
16	White balance	101
	White balance fine-tuning.....	103
	Preset manual.....	104
17	Color space	179
18	Picture Control.....	111
19	Quick adjust ³	113
	Original Picture Control ³	111
20	Sharpening	113
21	Contrast.....	113
22	Brightness	113
23	Saturation ³	113
	Filter effects ³	113
24	Hue ³	113
	Toning ³	113
25	High ISO noise reduction.....	180
	Long exposure noise reduction	179
26	Active D-Lighting	94
27	HDR (high dynamic range).....	96
28	Retouch history	205
29	Image comment	202

- 1 Displayed in red if photo was taken with auto ISO sensitivity control on.
- 2 Displayed only in photos taken with accessories that support this function.
- 3 May not be displayed depending on Picture Control used.

Overview Data

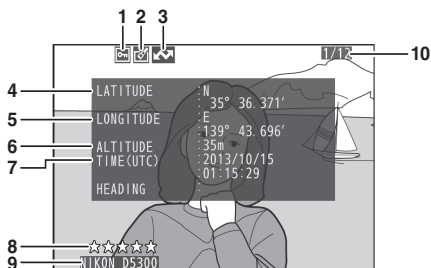


1 Frame number/total number of images	16 Shutter speed.....83
2 Protect status..... 143	17 Aperture83
3 Camera name	18 ISO sensitivity ¹67
4 Retouch indicator.....206	19 Focal length231
5 Upload marking.....173	20 Location data indicator.....74
6 Histogram showing the distribution of tones in the image (□ 137).	21 Image comment indicator202
7 Image quality.....59	22 Active D-Lighting.....94
8 Image size61	23 Picture Control111
9 File name.....189	24 Color space.....179
10 Time of recording.....15, 201	25 Flash mode.....63
11 Date of recording15, 201	26 White balance.....101
12 Folder name178	White balance fine-tuning.....103
13 Rating144	Preset manual.....104
14 Metering.....90	27 Flash compensation.....93
15 Shooting mode.....19, 30, 37, 82	Commander mode ²93
	28 Exposure compensation.....92

- 1 Displayed in red if photo was taken with ISO sensitivity auto control on.
- 2 Displayed only in photos taken with accessories that support this function.


Location Data

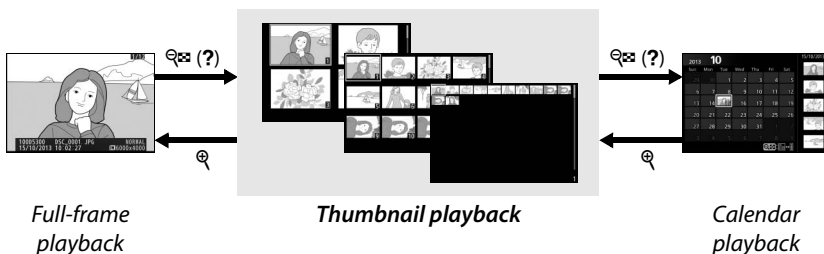
Location data are displayed only if location data were embedded in the picture when it was taken (□ 74). In the case of movies, the data give the location at the start of recording.













1 Protect status..... 143
2 Retouch indicator206
3 Upload marking.....173
4 Latitude
5 Longitude
6 Altitude
7 Coordinated Universal Time (UTC)
8 Rating..... 144
9 Camera name
10 Frame number/total number of images


Thumbnail Playback

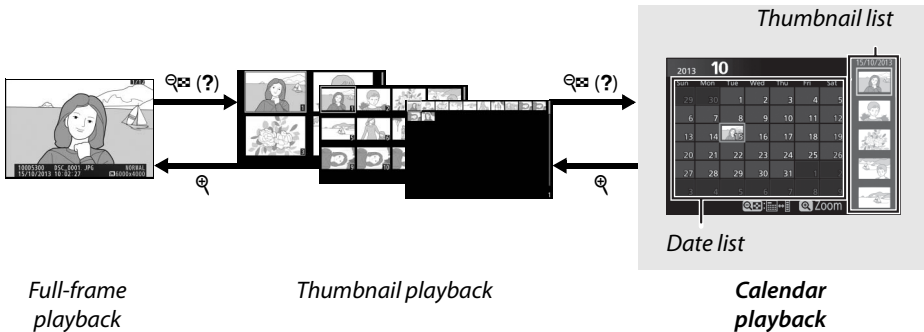
To display images in “contact sheets” of 4, 12, or 80 images, press the  (?) button.
















To	Use	Description
Display more images	 (?)	Press  (?) button to increase the number of images displayed.
Display fewer images		Press  button to reduce the number of images displayed. When four images are displayed, press to view highlighted image full frame.
Highlight images		Use multi selector or command dial to highlight pictures.
View highlighted image		Press  to display the highlighted image full frame.
Delete highlighted photo		See page 146 for more information.
Change protect status of highlighted photo	 ()	See page 143 for more information.

Calendar Playback


To view images taken on a selected date, press the  (?) button when 80 images are displayed.










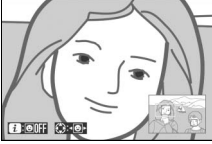





The operations that can be performed depend on whether the cursor is in the date list or the thumbnail list:

To	Use	Description
Toggle between date list and thumbnail list	 (?)	Press  (?) or  button in date list to place cursor in thumbnail list. Press  (?) again to return to date list.
		
Exit to thumbnail playback/Zoom in on highlighted photo		<ul style="list-style-type: none"> • Date list: Exit to 80-frame playback. • Thumbnail list: Press and hold  button to zoom in on highlighted picture.
Highlight dates/ Highlight images		<ul style="list-style-type: none"> • Date list: Highlight date. • Thumbnail list: Highlight picture.
Toggle full frame playback		<ul style="list-style-type: none"> • Thumbnail list: View highlighted picture.
Delete highlighted photo(s)		<ul style="list-style-type: none"> • Date list: Delete all pictures taken on selected date. • Thumbnail list: Delete highlighted picture ( 146).
Change protect status of highlighted photo	 ()	See page 143 for more information.

Taking a Closer Look: Playback Zoom

Press the  button to zoom in on the image displayed in full-frame playback or on the image currently highlighted in thumbnail or calendar playback. The following operations can be performed while zoom is in effect:

To	Use	Description
Zoom in or out	 /  (?)	Press  to zoom in to maximum of approximately 33× (large images), 25× (medium images) or 13× (small images). Press  (?) to zoom out. While photo is zoomed in, use multi selector to view areas of image not visible in monitor. Keep multi selector pressed to scroll rapidly to other areas of frame. Navigation window is displayed when zoom ratio is altered; area currently visible in monitor is indicated by yellow border. 
View other areas of image		Faces (up to 35) detected during zoom are indicated by white borders in navigation window. Press  and use the multi selector to view other faces, or press  to zoom in on the currently selected face. Press  again to return to normal zoom. 
View other images		Rotate command dial to view same location in other images at current zoom ratio. Playback zoom is cancelled when a movie is displayed.
Cancel zoom		Cancel zoom and return to full-frame playback.
Change protect status	 (On)	See page 143 for more information.

Protecting Photographs from Deletion

In full-frame, zoom, thumbnail, and calendar playback, the AE-L/AF-L (ⓘ) button can be used to protect photographs from accidental deletion. Protected files can not be deleted using the DEL button or the **Delete** option in the playback menu. Note that protected images *will* be deleted when the memory card is formatted (□ 196).

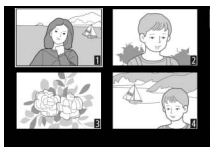
To protect a photograph:

1 Select an image.

Display the image in full-frame playback or playback zoom or highlight it in the thumbnail list in thumbnail or calendar playback.



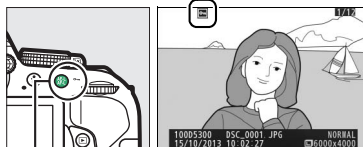
Full-frame playback



Thumbnail playback

2 Press the AE-L/AF-L (ⓘ) button.

The photograph will be marked with a ⓘ icon.



AE-L/AF-L (ⓘ) button

Removing Protection

To remove protection from individual pictures so that they can be deleted, display pictures full-frame or highlight them in the thumbnail list and then press the AE-L/AF-L (ⓘ) button. To remove protection from all images in the folder or folders currently selected in the **Playback folder** menu (□ 175), press the AE-L/AF-L (ⓘ) and DEL buttons together for about two seconds during playback.

Rating Pictures

Rate pictures or mark them as candidates for later deletion. Rating is not available with protected images.

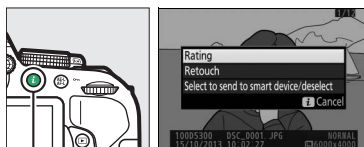
Rating Individual Pictures

1 Select an image.

Display the image in full-frame playback or playback zoom or highlight it in the thumbnail list in thumbnail or calendar playback.

2 Display playback options.

Press the **i** button to display playback options.



i button

3 Select Rating.

Highlight **Rating** and press **OK**.



4 Choose a rating.

Press **◀** or **▶** to choose a rating of from zero to five stars, or select **🗑️** to mark the picture as a candidate for later deletion.



5 Press **OK**.

Press **OK** to complete the operation.

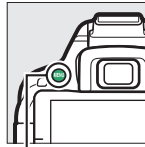


Rating Multiple Pictures

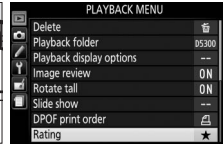
Use the **Rating** option in the playback menu to rate multiple pictures.

1 Select Rating.

Press the **MENU** button to display the camera menus, then highlight **Rating** in the playback menu and press **▶**.



MENU button



2 Rate pictures.

Press **◀** or **▶** to highlight pictures (to view the currently highlighted picture full frame, press and hold the **Q** button) and press **▲** or **▼** to choose a rating of from zero to five stars, or select **☆** to mark the picture as a candidate for later deletion.



3 Press **OK**.

Press **OK** to complete the operation.



Deleting Photographs

Unprotected photographs can be deleted as described below. Once deleted, photographs can not be recovered.

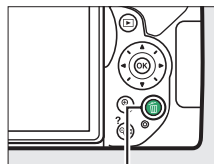
Full-Frame, Thumbnail, and Calendar Playback

1 Select an image.

Display the image or highlight it in the thumbnail list in thumbnail or calendar playback.

2 Press the button.

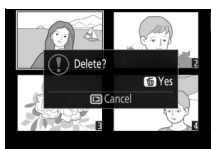
A confirmation dialog will be displayed.



 button





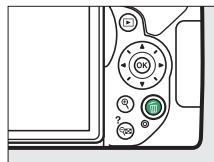
Full-frame playback





Thumbnail playback

3 Press the button again.

To delete the photograph, press the  button again. To exit without deleting the photograph, press the  button.



Calendar Playback

During calendar playback, you can delete all photographs taken on a selected date by highlighting the date in the date list and pressing the  button ( 141).

The Playback Menu

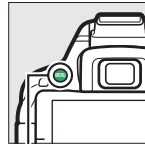
The **Delete** option in the playback menu contains the following options. Note that depending on the number of images, some time may be required for deletion.

Option	Description
Selected	Delete selected pictures.
Select date	Delete all pictures taken on a selected date.
ALL All	Delete all pictures in the folder currently selected for playback (📁 175).

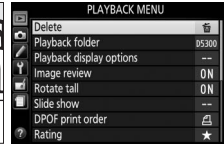
■ Selected: Deleting Selected Photographs

1 Select Delete.

To display the menus, press the **MENU** button. Highlight **Delete** in the playback menu and press **▶**.

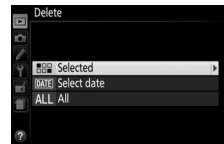


MENU button



2 Choose Selected.

Highlight **Selected** and press **▶**.



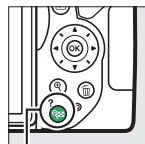
3 Highlight a picture.

Use the multi selector to highlight a picture (to view the highlighted picture full screen, press and hold the **Q** button).

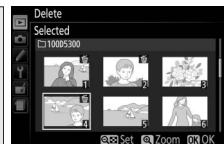


4 Select the highlighted picture.

Press the **Q** (?) button to select the highlighted picture. Selected pictures are marked by a icon. Repeat steps 3 and 4 to select additional pictures; to deselect a picture, highlight it and press **Q** (?) button.

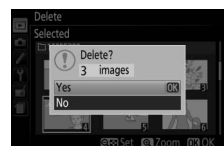


Q (?) button



5 Press **OK** to complete the operation.

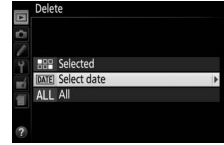
A confirmation dialog will be displayed; highlight **Yes** and press **OK**.



■ Select Date: Deleting Photographs Taken on a Selected Date

1 Choose Select Date.

In the delete menu, highlight **Select date** and press **▶**.

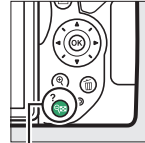


2 Highlight a date.

Press **▲** or **▼** to highlight a date.



To view the pictures taken on the highlighted date, press **Q** (?). Use the multi-selector to scroll through the pictures, or press and hold **Q** to view the current picture full screen. Press **Q** (?) to return to the date list.



Q (?) button



3 Select the highlighted date.

Press **▶** to select all pictures taken on the highlighted date. Selected dates are indicated by check marks. Repeat steps 2 and 3 to select additional dates; to deselect a date, highlight it and press **▶**.



4 Press **OK** to complete the operation.

A confirmation dialog will be displayed; highlight **Yes** and press **OK**.

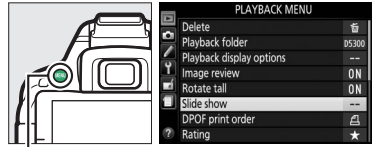


Slide Shows

The **Slide show** option in the playback menu is used to display a slide show of the pictures in the current playback folder (□ 175).

1 Select Slide show.

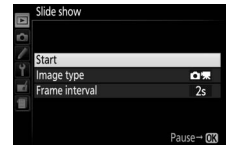
To display the slide show menu, press the **MENU** button and select **Slide show** in the playback menu.



MENU button

2 Start the slide show.

Highlight **Start** in the slide show menu and press **OK**.



The following operations can be performed while the slide show is in progress:

To	Use	Description
Skip back/skip ahead		Press ◀ to return to previous frame, ▶ to skip to next frame.
View additional photo info		Change photo info displayed (□ 136).
Pause/resume slide show		Pause show. Press again to resume.
Raise/lower volume		Press during movie playback to increase volume, (?) to decrease.
Exit to playback mode		End show and return to playback mode.

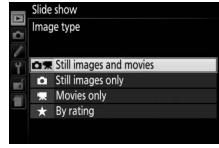
The dialog shown at right is displayed when the show ends. Select **Restart** to restart or **Exit** to return to the playback menu.



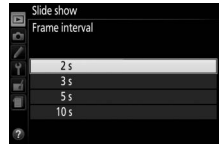
Slide Show Options

Before starting a slide show, you can use the options in the slide show menu to select the images displayed by type or rating and choose how long each image is displayed.

- **Image type:** Choose from **Still images and movies**, **Still images only**, **Movies only**, and **By rating**. To include only pictures with selected ratings, highlight **By rating** and press **▶**. A list of ratings will be displayed; highlight ratings and press **▶** to select or deselect pictures with the highlighted rating for inclusion in the slide show. Selected ratings are indicated by a check mark. Press **Ⓞ** to exit when the desired ratings are selected.



- **Frame interval:** Choose how long still images are displayed.



Connections

Installing ViewNX 2

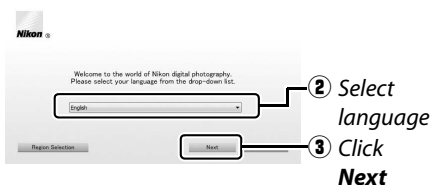
Install the supplied software to display and edit photographs and movies that have been copied to your computer. Before installing ViewNX 2, confirm that your computer meets the system requirements on page 152. Be sure to use the latest version of ViewNX 2, which is available for download from the websites listed on page xiv, as earlier versions that do not support the D5300 may fail to transfer NEF (RAW) images correctly.



1 Launch the installer.

Start the computer, insert the installer CD, and launch the installer. A language selection dialog will be displayed. If the desired language is not available, click **Region Selection** to choose a different region (region selection is not available in the European release).

① Select region (if required)



2 Start the installer.

Click **Install** and follow the on-screen instructions.



Click Install

3 Exit the installer.



4 Remove the installer CD from the CD-ROM drive.

System Requirements		Windows	Mac OS
CPU	<ul style="list-style-type: none"> • Photos: Intel Celeron, Pentium 4, Core Series; 1.6 GHz or better • Movies (playback): 3.0 GHz or better Pentium D; Intel Core i5 or better recommended when viewing movies with a frame size of 1280×720 or more at a frame rate of 30 fps or above or movies with a frame size of 1920×1080 or more • Movies (editing): Intel Core i5 or better 	<ul style="list-style-type: none"> • Photos: Intel Core or Xeon series • Movies (playback): Core Duo 2 GHz or better; Intel Core i5 or better recommended when viewing movies with a frame size of 1280×720 or more at a frame rate of 30 fps or above or movies with a frame size of 1920×1080 or more • Movies (editing): Intel Core i5 or better 	
OS	Pre-installed versions of Windows 8, Windows 7, Windows Vista, and Windows XP; note that 64-bit versions of Windows XP are not supported	OS X 10.8 or 10.7, Mac OS X 10.6	
Memory (RAM)	<ul style="list-style-type: none"> • 32-bit Windows 8, Windows 7, or Windows Vista: 1 GB or more (2 GB or more recommended) • 64-bit Windows 8, Windows 7, or Windows Vista: 2 GB or more (4 GB or more recommended) • Windows XP: 512 MB or more (2 GB or more recommended) 	<ul style="list-style-type: none"> • OS X 10.8, 10.7: 2 GB or more (4 GB or more recommended) • Mac OS X 10.6: 1 GB or more (4 GB or more recommended) 	
Hard disk space	A minimum of 1 GB available on the startup disk (3 GB or more recommended)		
Graphics	Resolution: 1024×768 pixels (XGA) or more (1280×1024 pixels or more recommended) Color: 24-bit color (True Color) or more	Resolution: 1024×768 pixels (XGA) or more (1280×1024 pixels or more recommended) Color: 24-bit color (millions of colors) or more	
See the websites listed on page xiv for the latest information on supported operating systems.			

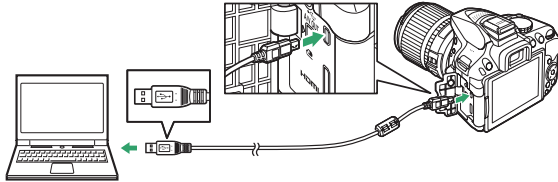
Using ViewNX 2

Copy Pictures to the Computer

Before proceeding, be sure you have installed the software on the supplied ViewNX 2 CD (☞ 151).

1 Connect the USB cable.

After turning the camera off and ensuring that a memory card is inserted, connect the supplied USB cable as shown and then turn the camera on.



Use a Reliable Power Source

To ensure that data transfer is not interrupted, be sure the camera battery is fully charged.

Connecting Cables

Be sure the camera is off when connecting or disconnecting interface cables. Do not use force or attempt to insert the connectors at an angle. Close the connector cover when the connector is not in use.

USB Hubs

Transfer may not proceed as expected if the camera is connected via a USB hub or keyboard.

2 Start Nikon Transfer 2 component of ViewNX 2.

If a message is displayed prompting you to choose a program, select Nikon Transfer 2.

Windows 7

If the following dialog is displayed, select Nikon Transfer 2 as described below.

- 1 Under **Import pictures and videos**, click **Change program**. A program selection dialog will be displayed; select **Import File using Nikon Transfer 2** and click **OK**.

- 2 Double-click **Import File**.



3 Click Start Transfer.

At default settings, pictures on the memory card will be copied to the computer.

During Transfer

Do not turn the camera off or disconnect the USB cable while transfer is in progress.



Start Transfer

4 Terminate the connection.

When transfer is complete, turn the camera off and disconnect the USB cable.

View Pictures

Pictures are displayed in ViewNX 2 when transfer is complete.

Starting ViewNX 2 Manually

- Windows: Double-click the ViewNX 2 shortcut on the desktop.
- Mac OS: Click the ViewNX 2 icon in the Dock.



■ ■ Retouching Photographs

To crop pictures and perform such tasks as adjusting sharpness and tone levels, click the **Edit** button in the ViewNX 2 toolbar.



■ ■ Editing Movies

To perform such tasks as trimming unwanted footage from movies shot with the camera, click the **Movie Editor** button in the ViewNX 2 toolbar.



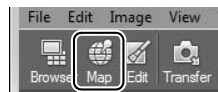
■ ■ Printing Pictures

Click the **Print** button in the ViewNX 2 toolbar. A dialog will be displayed, allowing you to print pictures on a printer connected to the computer.



■ ■ Viewing Location Data

To view the locations where pictures were taken or display track logs, click the **Map** button in the ViewNX 2 toolbar.



For More Information

Consult online help for more information on using ViewNX 2.



Viewing the Nikon Website

To visit the Nikon website after installing ViewNX 2, select **All Programs > Link to Nikon** from the Windows start menu (Internet connection required).

Printing Photographs

Selected JPEG images can be printed on a PictBridge printer (☞ 265) connected directly to the camera.

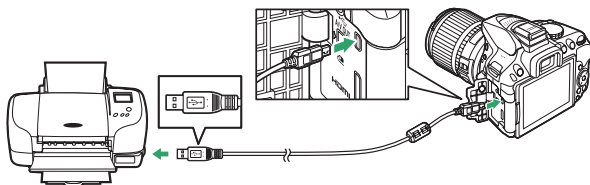
Connecting the Printer

Connect the camera using the supplied USB cable.

1 Turn the camera off.

2 Connect the USB cable.

Turn the printer on and connect the USB cable as shown. Do not use force or attempt to insert the connectors at an angle.



3 Turn the camera on.

A welcome screen will be displayed in the monitor, followed by a PictBridge playback display.

✓ **Selecting Photographs for Printing**

NEF (RAW) photographs (☞ 59) can not be selected for printing. JPEG copies of NEF (RAW) images can be created using the **NEF (RAW) processing** option in the retouch menu (☞ 213).

Printing Pictures One at a Time

1 Select a picture.

Press ◀ or ▶ to view additional pictures. Press the Ⓞ button to zoom in on the current frame (□ 142; press ▶ to exit zoom). To view eight pictures at a time, press the Ⓞ (?) button. Use the multi selector to highlight pictures, or press Ⓞ to display the highlighted picture full frame.



2 Display printing options.

Press Ⓞ to display PictBridge printing options.





3 Adjust printing options.

Press ▲ or ▼ to highlight an option and press ▶ to select.


Option	Description
Page size	Highlight a page size (only sizes supported by the current printer are listed) and press Ⓞ to select and exit to the previous menu (to print at the default page size for the current printer, select Printer default).
No. of copies	Press ▲ or ▼ to choose number of copies (maximum 99), then press Ⓞ to select and return to the previous menu.
Border	This option is available only if supported by the printer. Highlight Printer default (use current printer settings), Print with border (print photo with white border), or No border and press Ⓞ to select and exit to the previous menu.
Time stamp	Highlight Printer default (use current printer settings), Print time stamp (print times and dates of recording on photos), or No time stamp and press Ⓞ to select and exit to the previous menu.
Cropping	This option is available only if supported by the printer. To exit without cropping, highlight No cropping and press Ⓞ. To crop the current picture, highlight Crop and press ▶. A crop selection dialog will be displayed; press Ⓞ to increase the size of the crop, Ⓞ (?) to decrease. Position the crop using the multi selector and press Ⓞ. Note that print quality may drop if small crops are printed at large sizes.

4 Start printing.

Select **Start printing** and press  to start printing. To cancel before all copies have been printed, press .



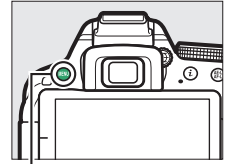
Date Imprint

If you select **Print time stamp** in the PictBridge menu when printing photographs containing date information recorded using Custom Setting d6 (**Print date**;  190), the date will appear twice. The imprinted date may however be cropped out if the photographs are cropped or printed without a border.

Printing Multiple Pictures

1 Display the PictBridge menu.

Press the **MENU** button in the PictBridge playback display (see Step 3 on page 156).



MENU button



2 Choose an option.

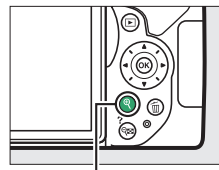
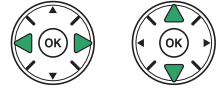
Highlight one of the following options and press ►.


- **Print select:** Select pictures for printing.
- **Select date:** Print one copy of all the pictures taken on a selected date.
- **Print (DPOF):** Print an existing print order created with the **DPOF print order** option in the playback menu (☞ 162). The current print order will be displayed in Step 3.
- **Index print:** To create an index print of all JPEG pictures on the memory card, proceed to Step 4. Note that if the memory card contains more than 256 pictures, only the first 256 images will be printed.






3 Select pictures or choose a date.


If you chose **Print select** or **Print (DPOF)** in Step 2, press ◀ or ▶ to scroll through the pictures on the memory card. To display the current picture full screen, press and hold the  button. To select the current picture for printing, press ▲. The picture will be marked with a  icon and the number of prints will be set to 1; press ▲ or ▼ to specify the number of prints (up to 99; to deselect the picture, press ▼ when the number of prints is 1).

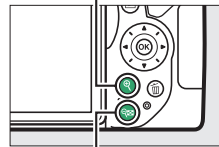



 **button:** View photo full screen

If you chose **Select date** in Step 2, press ▲ or ▼ to highlight a date and press ▶ to toggle the highlighted date on or off. To view the pictures taken on the selected date, press  (?). Use the multi selector to scroll through the pictures, or press and hold  to view the current picture full screen. Press  (?) again to return to the date selection dialog.



 **button:** View highlighted photo full screen



 **(?) button:** View photos for selected date

4 Display printing options.

Press **OK** to display PictBridge printing options.



5 Adjust printing options.

Choose page size, border, and time stamp options as described on page 157 (a warning will be displayed if the selected page size is too small for an index print).

6 Start printing.

Select **Start printing** and press **OK** to start printing. To cancel before all copies have been printed, press **OK**.

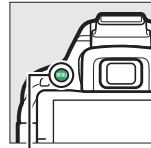


Creating a DPOF Print Order: Print Set

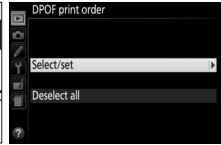
The **DPOF print order** option in the playback menu is used to create digital “print orders” for PictBridge-compatible printers and devices that support DPOF.

1 Choose **Select/set** for the **DPOF print order** item in the playback menu.

Press the **MENU** button and select **DPOF print order** in the playback menu. Highlight **Select/set** and press **▶** (to remove all photographs from the print order, select **Deselect all**).

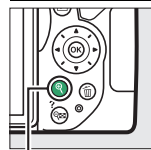


MENU button



2 Select pictures.

Press **◀** or **▶** to scroll through the pictures on the memory card. To display the current picture full screen, press and hold the **Ⓚ** button. To select the current picture for printing, press **▲**. The picture will be marked with a **📄** icon and the number of prints will be set to 1; press **▲** or **▼** to specify the number of prints (up to 99; to deselect the picture, press **▼** when the number of prints is 1). Continue until all the desired pictures have been selected.

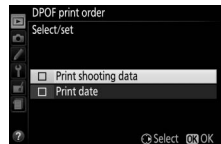


Ⓚ button: View photo full screen



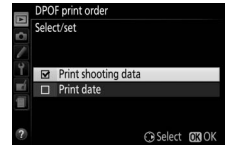
3 Display imprint options.

Press **Ⓚ** to display data imprint options.



4 Select imprint options.

Highlight the following options and press ► to toggle the highlighted option on or off (to complete the print order without including this information, proceed to Step 5).



- **Print shooting data:** Print shutter speed and aperture on all pictures in print order.
- **Print date:** Print date of recording on all pictures in print order.

5 Complete the print order.

Press **OK** to complete the print order.



✓ DPOF Print Order

To print the current print order when the camera is connected to a PictBridge printer, select **Print (DPOF)** in the PictBridge menu and follow the steps in “Printing Multiple Pictures” to modify and print the current order (□ 159). DPOF print date and shooting data options are not supported when printing via direct USB connection; to print the date of recording on photographs in the current print order, use the PictBridge **Time stamp** option.

The **DPOF print order** option can not be used if there is not enough space on the memory card to store the print order.

NEF (RAW) photographs (□ 59) can not be selected using this option. JPEG copies of NEF (RAW) images can be created using the **NEF (RAW) processing** option in the retouch menu (□ 213).

Print orders may not print correctly if images are deleted using a computer or other device after the print order is created.

Viewing Pictures on TV

The supplied audio video (A/V) cable can be used to connect the camera to a television or video recorder for playback or recording. A High-Definition Multimedia Interface (HDMI) cable (available separately from third-party suppliers) with a mini HDMI connector (Type C) can be used to connect the camera to high-definition video devices.

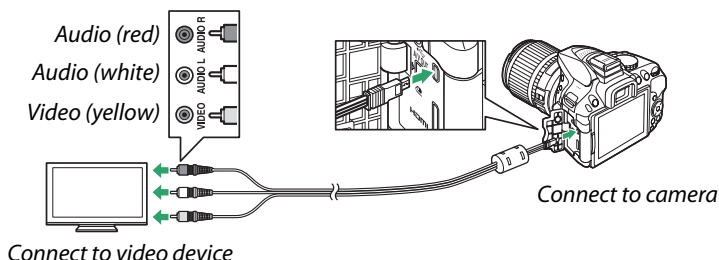
Standard Definition Devices

Before connecting the camera to a standard television, confirm that the camera video standard (📖 202) matches that used in the TV.

1 Turn the camera off.

Always turn the camera off before connecting or disconnecting the A/V cable.

2 Connect the A/V cable as shown.



3 Tune the television to the video channel.

4 Turn the camera on and press the button.

During playback, images will be displayed on the television screen. Note that the edges of images may not be displayed.

Video Mode

If no image is displayed, check that camera is correctly connected and that the option selected for **Video mode** (📖 202) matches the video standard used in the TV.

Television Playback

Use of an AC adapter (available separately) is recommended for extended playback.

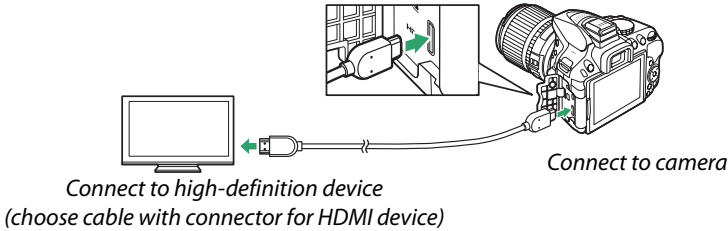
High-Definition Devices

The camera can be connected to HDMI devices using a third-party HDMI cable with a mini HDMI connector (Type C).

1 Turn the camera off.

Always turn the camera off before connecting or disconnecting an HDMI cable.

2 Connect the HDMI cable as shown.



3 Tune the device to the HDMI channel.

4 Turn the camera on and press the button.

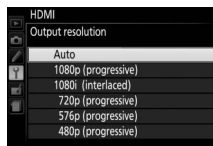
During playback, images will be displayed on the high-definition television or monitor screen. Note that the edges of images may not be displayed.

Playback Volume

Volume can be adjusted using television controls; the camera controls can not be used.

■ ■ Choosing an Output Resolution

To choose the format for images output to the HDMI device, select **HDMI > Output resolution** in the camera setup menu (☰ 195). If **Auto** is selected, the camera will automatically select the appropriate format.



■ ■ Controlling the Camera with the TV Remote

If **On** is selected for **HDMI > Device control** in the setup menu (☰ 195) when the camera is connected to a television that supports HDMI-CEC and both the camera and television are on, the television remote can be used in place of the camera multi selector and **OK** button during full-frame playback and slide shows. If **Off** is selected, the television remote can not be used to control the camera, but the camera can be used to shoot photographs and movies in live view.

HDMI-CEC Devices

HDMI-CEC (High-Definition Multimedia Interface–Consumer Electronics Control) is a standard that allows HDMI devices to be used to control peripherals to which they are connected. When the camera is connected to an HDMI-CEC device, **ⓧ** will appear in the viewfinder in place of the number of exposures remaining.

1920 × 1080 60p/50p

Selecting **1920 × 1080; 60p** or **1920 × 1080; 50p** for **Movie settings > Frame size/frame rate** may cause variations in the resolution and frame rate of the data output to HDMI devices during recording. During playback (☰ 130), HDMI devices will display the movie only; indicators will not be displayed.

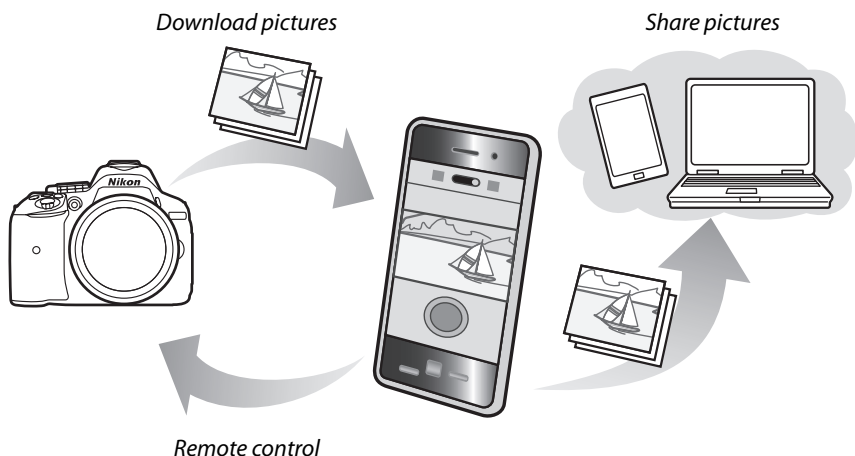
HDMI > Output Resolution

Movies can not be output at resolutions of **1920 × 1080; 60p** or **1920 × 1080; 50p**. Some devices may not support an **Output resolution** setting of **Auto**; in this case, select **1080i (interlaced)**.

Wi-Fi

What Wi-Fi Can Do for You

Install the Wireless Mobile Utility app on your Android and iOS device to display the view through the camera lens on the smart device, take pictures and control the camera remotely, and download pictures from the camera for sharing via the Internet.



See the Wireless Mobile Utility manual for details (📖 168).

Accessing the Camera

Before connecting via Wi-Fi (wireless LAN), install the Wireless Mobile Utility on your Android or iOS smart device. Instructions for accessing the camera vary with the type of connection used by the smart device.

Android

- **Push-button WPS:** If the smart device supports push-button WPS (i.e., has a **WPS button connection** option in its **Wi-Fi settings** menu), you can use this easy method to connect to the smart device (☞ 169)
- **PIN-entry WPS:** If the smart device supports WPS, you can use the camera to establish a connection by entering the PIN displayed by the smart device (☞ 170)
- **View SSID:** If the smart device does not support WPS, you can connect by selecting the camera SSID on the smart device (☞ 171)

iOS

- **View SSID:** Connect by selecting the camera SSID on the smart device (☞ 171)

Installing the App

1 Find the app.

On the smart device, connect to the Google Play service, the App Store, or another app marketplace and search for “Wireless Mobile Utility”. For more information, see the instructions provided with the smart device.

2 Install the app.

Read the app description and install the app. A pdf manual for the Wireless Mobile Utility is available for download at the following URLs:

- **Android:** <http://nikonimglib.com/ManDL/WMAU/>
- **iOS:** <http://nikonimglib.com/ManDL/WMAU-ios/>

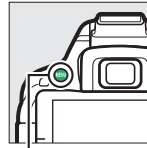
WPS

WPS (Wi-Fi Protected Setup) is a standard designed to make it easy to establish a secure wireless network. For information on the steps involved and the length of time the smart device will wait for a connection, see the documentation supplied with the smart device.

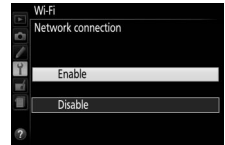
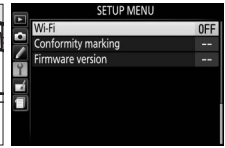
WPS (Android Only)

1 Enable the camera's built-in Wi-Fi.

Press the **MENU** button to display the menus, then highlight **Wi-Fi** in the setup menu and press **▶**. Highlight **Network connection** and press **▶**, then highlight **Enable** and press **OK**. Wait a few seconds for Wi-Fi to activate.



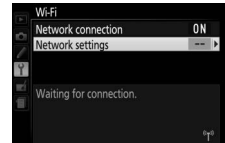
MENU button



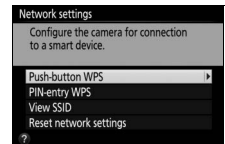
2 Connect.

Enable WPS button connections on the camera and smart device:

- **Camera:** Highlight **Network settings** and press **▶**.



Highlight **Push-button WPS** and press **▶** to ready the camera for a WPS connection. The camera will wait about two minutes for a WPS connection request from the smart device. To extend the wait time, press **OK**.



- **Smart device:** Select **Wi-Fi settings** > **WPS button connection**.

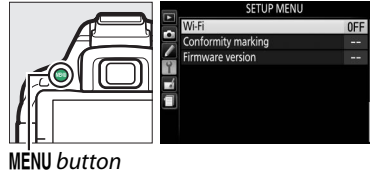
3 Launch the Wireless Mobile Utility.

Launch the Wireless Mobile Utility on the smart device. The main dialog will be displayed.

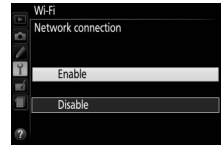
PIN Entry (Android Only)

1 Enable the camera's built-in Wi-Fi.

Press the **MENU** button to display the menus, then highlight **Wi-Fi** in the setup menu and press **▶**. Highlight **Network connection** and press **▶**, then highlight **Enable** and press **Ⓞ**. Wait a few seconds for Wi-Fi to activate.



MENU button

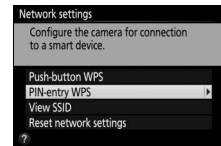
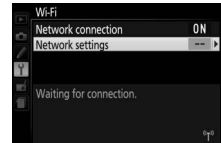


2 Select Network settings > PIN-entry WPS.

Highlight **Network settings** and press **▶**.



Highlight **PIN-entry WPS** and press **▶**.



3 Enter the PIN.

Enter the PIN displayed by the smart device. Press **◀** or **▶** to highlight digits and press **▲** or **▼** to change. Press **Ⓞ** when entry is complete.

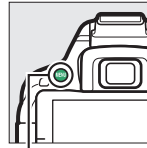
4 Launch the Wireless Mobile Utility.

Launch the Wireless Mobile Utility on the smart device. The main dialog will be displayed.

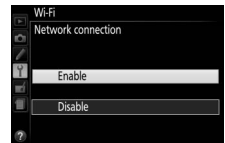
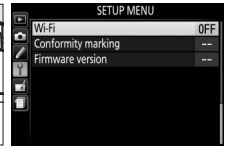
SSID (Android and iOS)

1 Enable the camera's built-in Wi-Fi.

Press the **MENU** button to display the menus, then highlight **Wi-Fi** in the setup menu and press **▶**. Highlight **Network connection** and press **▶**, then highlight **Enable** and press **OK**. Wait a few seconds for Wi-Fi to activate.



MENU button

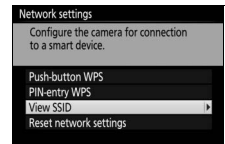
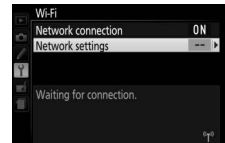


2 Display the camera SSID.

Highlight **Network settings** and press **▶**.



Highlight **View SSID** and press **▶**.



3 Select the camera SSID.

Select the camera SSID in the list of networks displayed by the smart device.

4 Launch the Wireless Mobile Utility.

Launch the Wireless Mobile Utility on the smart device. The main dialog will be displayed.

■ ■ Terminating the Connection


Wi-Fi can be disabled by:

- Selecting **Wi-Fi > Network connection > Disable** in the camera setup menu
- Starting movie recording
- Turning the camera off

■ ■ Restoring Default Settings

To restore default network settings, select **Wi-Fi > Network settings > Reset network settings**. A confirmation dialog will be displayed; highlight **Yes** and press **OK** to restore default network settings.

The Wi-Fi Display

While Wi-Fi is enabled, a  icon will flash in the information display. The icon will stop flashing once a connection has been established and the camera is exchanging data with the smart device.



Wi-Fi

Read the warnings on pages xvii to xviii before using the Wi-Fi function. To disable Wi-Fi in settings in which its use is prohibited, select **Wi-Fi > Network connection > Disable** in the camera setup menu. Note that Eye-Fi cards can not be used while Wi-Fi is enabled and that the standby timer will not turn off while the Wireless Mobile Utility app on the smart device is communicating with the camera. If no data are exchanged for about 5 minutes, the standby timer will turn off. The camera Wi-Fi function is only available when a memory card is inserted and can not be used when a USB or HDMI cable is connected. To prevent loss of power while connected, charge the battery before enabling the network connection.

Selecting Pictures for Upload

Follow the steps below to select photos for upload to the smart device. Movies can not be selected for upload.

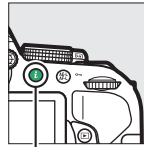
Selecting Individual Pictures for Upload

1 Select an image.

Display the image or highlight it in the thumbnail list in thumbnail or calendar playback.

2 Display playback options.


Press the **i** button



i button



3 Choose Select to send to smart device/deselect.

Highlight **Select to send to smart device/deselect** and press **OK**. Pictures selected for upload are indicated by a  icon; to deselect, display or highlight the image and repeat Steps 2 and 3.



The Icon

The  icon will no longer be displayed when upload is complete.

Selecting Multiple Pictures for Upload

To change the upload status of multiple pictures, use the **Select to send to smart device** option in the playback menu.

1 Choose **Select to send to smart device**.

To display the menus, press the **MENU** button. Highlight **Select to send to smart device** in the playback menu and press **▶**.



MENU button

2 Select pictures.

Use the multi selector to highlight pictures and press **Ⓚ(?)** to select or deselect (to view the highlighted picture full screen, press and hold the **Ⓚ** button). Selected pictures are marked by a **📌** icon.



Ⓚ(?) button

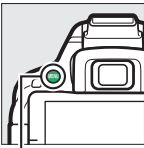
3 Press **Ⓚ**.

Press **Ⓚ** to complete the operation.

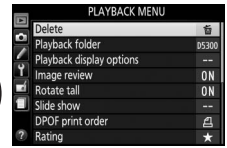
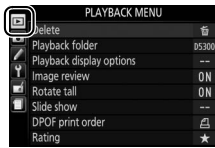
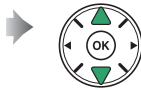
Camera Menus

▶ The Playback Menu: *Managing Images*

To display the playback menu, press **MENU** and select the ▶ (playback menu) tab.



MENU button



The playback menu contains the following options:

Option	Default	📖
Delete	—	147
Playback folder	Current	175
Playback display options	—	176
Image review	On	176
Rotate tall	On	176
Slide show	—	
Image type	Still images and movies	149
Frame interval	2 s	
DPOF print order	—	162
Rating	—	145
Select to send to smart device	—	174

Playback Folder



MENU button → ▶ playback menu

Choose a folder for playback:

Option	Description
Current	Only photos in the folder currently selected for Storage folder in the shooting menu (📖 178) are displayed during playback. This option is selected automatically when a photo is taken; select All to view pictures in all folders.
All	Pictures in all folders will be visible during playback.

Playback Display Options

MENU button →  playback menu

Choose the information available in the playback photo information display ( 136). Press ▲ or ▼ to highlight and press ► to select or deselect. Selected items are indicated by check marks. To return to the playback menu, press .

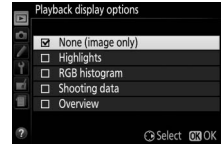



Image Review

MENU button →  playback menu

Choose whether pictures are automatically displayed in the monitor immediately after shooting.

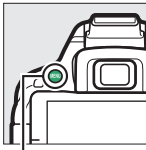
Rotate Tall

MENU button →  playback menu

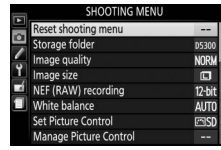
If **On** is selected, “tall” (portrait-orientation) pictures will be automatically rotated for display in the monitor (pictures taken with **Off** selected for **Auto image rotation** will still be displayed in landscape orientation;  202). Note that because the camera itself is already in the appropriate orientation during shooting, images are not rotated automatically during image review.

The Shooting Menu: *Shooting Options*


To display the shooting menu, press **MENU** and select the  (shooting menu) tab.





MENU button



The shooting menu contains the following options:

Option	Default	
Reset shooting menu	—	177
Storage folder	—	178
Image quality	JPEG normal	59
Image size	Large	61
NEF (RAW) recording	12-bit	178
White balance	Auto	101
Fluorescent	Cool-white fluorescent	102
Set Picture Control	Standard	111
Manage Picture Control	—	115
Auto distortion control	Off	179
Color space	sRGB	179
Active D-Lighting	Auto	94
HDR (high dynamic range)	Off	96
Long exposure NR	Off	179
High ISO NR	Normal	180
ISO sensitivity settings		
ISO sensitivity	P, S, A, M	100
	Other modes	Auto
Auto ISO sensitivity control	Off	180

Option	Default	
Release mode		
	Continuous H	45
Other modes	Single frame	
Multiple exposure		
Multiple exposure mode	Off	98
Number of shots	2	
Auto gain	On	
Interval timer shooting	Off	68
Optical VR ¹	On	181
Movie settings		
Frame size/frame rate ²	—	128
Movie quality	Normal	
Microphone	Auto sensitivity	
Wind noise reduction	Off	
Manual movie settings	Off	

1 Available only with lenses that support this item.

2 Default varies with country of purchase.

Note: Depending on camera settings, some items may be grayed out and unavailable.

Reset Shooting Menu

MENU button →  shooting menu

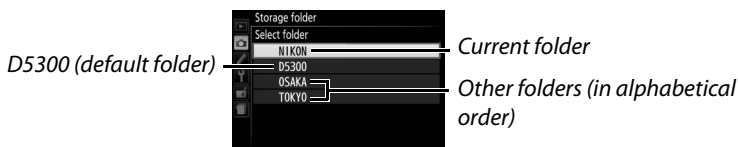
Select **Yes** to reset shooting menu settings.

Storage Folder

MENU button →  shooting menu

Create, rename, or delete folders, or choose the folder in which subsequent photographs will be stored.

- **Select folder:** Choose the folder in which subsequent photographs will be stored.



- **New:** Create a new folder and name it as described on page 116. Folder names can be up to five characters long.
- **Rename:** Select a folder from the list and rename it as described on page 116.
- **Delete:** Delete all empty folders on the memory card.

Folder Names

On the memory card, folder names are preceded by a three-digit folder number assigned automatically by the camera (e.g., 100D5300). Each folder can contain up to 999 photographs. During shooting, pictures are stored in the highest-numbered folder with the selected name. If a photograph is taken when the current folder is full or contains a photograph numbered 9999, the camera will create a new folder by adding 1 to the current folder number (e.g., 101D5300). The camera treats folders with the same name but different folder numbers as the same folder. For example, if the folder NIKON is selected for **Storage folder**, photographs in all folders named NIKON (100NIKON, 101NIKON, 102NIKON, etc.) will be visible when **Current** is selected for **Playback folder** (🗨 175). Renaming changes all folders with the same name but leaves the folder numbers intact. Selecting **Delete** deletes empty numbered folders but leaves other folders with the same name intact.

NEF (RAW) Recording

MENU button →  shooting menu

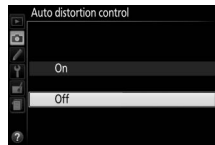
Choose the bit depth for NEF (RAW) images.

Option	Description
12-bit 12-bit	NEF (RAW) images are recorded at a bit depth of 12 bits.
14-bit 14-bit	NEF (RAW) images are recorded at a bit depth of 14 bits, producing larger files but increasing the amount of color data recorded.

Auto Distortion Control

MENU button →  shooting menu

Select **On** to reduce barrel distortion in photos taken with wide-angle lenses and to reduce pin-cushion distortion in photos taken with long lenses (note that the edges of the area visible in the viewfinder may be cropped out of the final photograph, and that the time needed to process photographs before recording begins may increase). This option does not apply to movies and is available only with type G, E, and D lenses (PC, fisheye, and certain other lenses excluded); results are not guaranteed with other lenses.



Color Space

MENU button →  shooting menu

The color space determines the gamut of colors available for color reproduction. **sRGB** is recommended for movies and for general-purpose printing and display, **Adobe RGB**, with its broader gamut of colors, for professional publication and commercial printing.



Adobe RGB

For accurate color reproduction, Adobe RGB images require applications, displays, and printers that support color management.

Color Space

ViewNX 2 (supplied) and Capture NX 2 (available separately) automatically select the correct color space when opening photographs created with this camera. Results can not be guaranteed with third-party software.

Long Exposure NR

MENU button →  shooting menu

If **On** is selected, photographs taken at shutter speeds slower than 1 s will be processed to reduce noise (bright spots, randomly-spaced bright pixels, or fog). The time required for processing roughly doubles; during processing, "Lob nr" will flash in the viewfinder and pictures can not be taken (noise reduction will not be performed if the camera is turned off before processing is complete).



High ISO NR

MENU button →  shooting menu

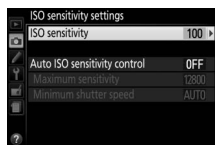
Photographs taken at high ISO sensitivities can be processed to reduce “noise.”

Option	Description
High	Reduce noise (randomly-spaced bright pixels, lines, or fog), particularly in photographs taken at high ISO sensitivities. Choose the amount of noise reduction performed from High , Normal , and Low .
Normal	
Low	
Off	Noise reduction is only performed as required. The amount of noise reduction is less than the amount performed when Low is selected for High ISO NR .

ISO Sensitivity Settings

MENU button →  shooting menu

Adjust ISO sensitivity (☰ 67).



■ Auto ISO Sensitivity control

If **Off** is chosen for **Auto ISO sensitivity control** in **P**, **S**, **A**, and **M** modes, ISO sensitivity will remain fixed at the value selected by the user (☰ 67). When **On** is chosen, ISO sensitivity will automatically be adjusted if optimal exposure can not be achieved at the value selected by the user. The maximum value for auto ISO sensitivity can be selected using the **Maximum sensitivity** option in the **Auto ISO sensitivity control** menu (choose lower values to prevent noise (randomly-spaced bright pixels, fog, or lines, but note that if the ISO sensitivity selected by the user is higher than that chosen for **Maximum sensitivity**, the value selected by the user will be used instead; the minimum value for auto ISO sensitivity is automatically set to ISO 100)). In modes **P** and **A**, sensitivity will only be adjusted if underexposure would result at the shutter speed selected for **Minimum shutter speed** ($1/2000$ – 1 s, or **Auto**; in modes **S** and **M**, sensitivity will be adjusted for optimal exposure at the shutter speed selected by the user). If **Auto** (available only with CPU lenses) is selected, the camera will choose the minimum shutter speed based on the focal length of the lens (auto shutter-speed selection can be fine-tuned by highlighting **Auto** and pressing ►). Slower shutter speeds will be used only if optimum exposure can not be achieved at the ISO sensitivity value selected for **Maximum sensitivity**.

When **On** is selected, the viewfinder shows **ISO-AUTO** and the information display **ISO-A**. These indicators flash when sensitivity is altered from the value selected by the user.



Maximum Sensitivity/Minimum Shutter Speed

When auto ISO sensitivity control is enabled, the ISO sensitivity and shutter speed graphics in the information display show the maximum sensitivity and minimum shutter speed.

Minimum shutter speed



Maximum sensitivity

Auto ISO Sensitivity Control

Noise (randomly-spaced bright pixels, fog, or lines) is more likely at higher sensitivities. Use the **High ISO NR** option in the shooting menu to reduce noise (□ 180). Note that ISO sensitivity may be raised automatically when auto ISO sensitivity control is used in combination with slow sync flash modes (available with the built-in flash and the optional flash units listed on page 232), possibly preventing the camera from selecting slow shutter speeds. Auto ISO sensitivity control is available only in i-TTL flash control mode (□ 192, 233); in other modes, the value selected for **ISO sensitivity** will be used for pictures taken with the built-in flash or optional flash units.

Optical VR

MENU button → shooting menu


This item is displayed only with lenses that support it. Selecting **On** enables vibration reduction, which takes effect whenever the shutter-release button is pressed halfway (□ 268). Select **Off** to disable vibration reduction.

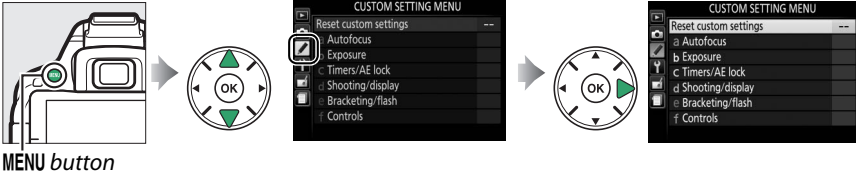
The Vibration Reduction Indicator

A vibration reduction indicator appears in the information display when **On** is selected for **Optical VR**.



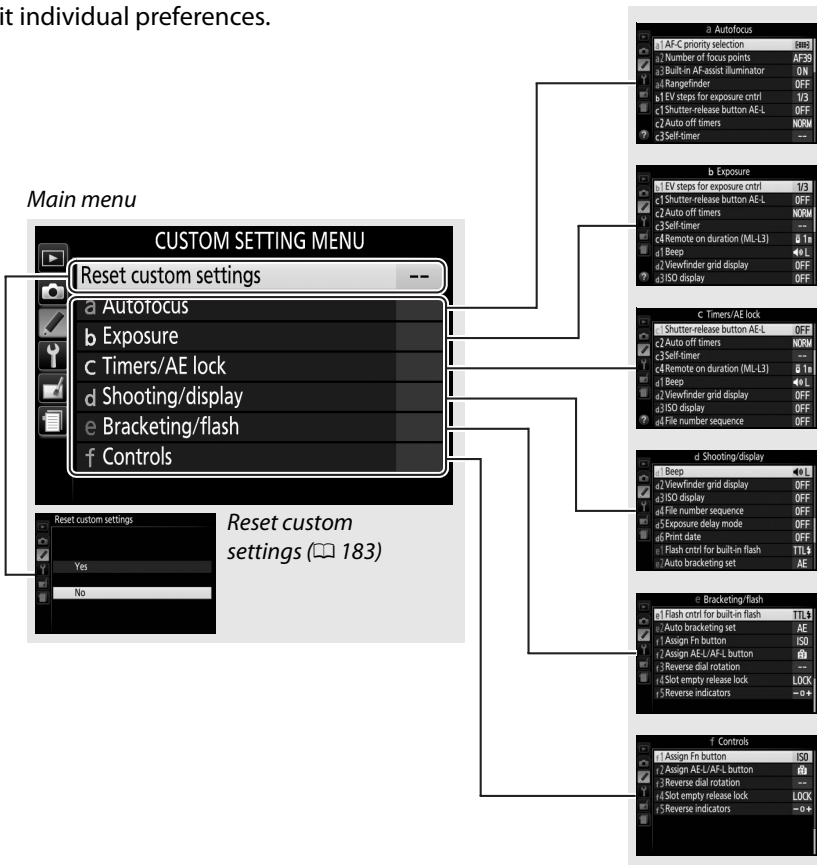
Custom Settings: Fine-Tuning Camera Settings

To display the Custom Settings menu, press **MENU** and select the  (Custom Settings menu) tab.





Custom Settings are used to customize camera settings to suit individual preferences.

Custom Setting groups




The following Custom Settings are available:

Custom Setting		Default	
Reset custom settings			183
a Autofocus			
a1	AF-C priority selection	Focus	184
a2	Number of focus points	39 points	184
a3	Built-in AF-assist illuminator	On	185
a4	Rangefinder	Off	185
b Exposure			
b1	EV steps for exposure cntrl	1/3 step	186
c Timers/AE lock			
c1	Shutter-release button AE-L	Off	186
c2	Auto off timers	Normal	186
c3	Self-timer	Self-timer delay: 10 s; number of shots: 1	187
c4	Remote on duration (ML-L3)	1 min	187
d Shooting/display			
d1	Beep	Low	187
d2	Viewfinder grid display	Off	188
d3	ISO display	Off	188
d4	File number sequence	Off	188
d5	Exposure delay mode	Off	189
d6	Print date	Off	190
e Bracketing/flash			
e1	Flash cntrl for built-in flash	TTL	192
e2	Auto bracketing set	AE bracketing	192
f Controls			
f1	Assign Fn button	ISO sensitivity	193
f2	Assign AE-L/AF-L button	AE/AF lock	194
f3	Reverse dial rotation	Exposure compensation: <input type="checkbox"/> Shutter speed/aperture: <input type="checkbox"/>	194
f4	Slot empty release lock	Release locked	194
f5	Reverse indicators		194

Note: Depending on camera settings, some items may be grayed out and unavailable.

Reset Custom Settings


MENU button →  Custom Settings menu



Select **Yes** to restore Custom Settings to their default values.

a: Autofocus

a1: AF-C Priority Selection

MENU button →  Custom Settings menu

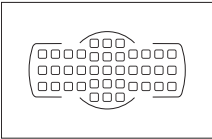
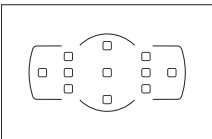
When **AF-C** is selected for viewfinder photography ( 51), this option controls whether photographs can be taken whenever the shutter-release button is pressed (*release priority*) or only when the camera is in focus (*focus priority*).

Option	Description
 Release	Photos can be taken whenever the shutter-release button is pressed.
 Focus	Photos can only be taken once the camera has focused.

a2: Number of Focus Points

MENU button →  Custom Settings menu

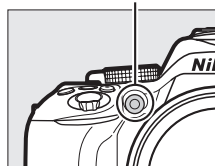
Choose the number of focus points available for manual focus-point selection.

Option	Description
AF39 39 points	Choose from the 39 focus points shown at right. 
AF11 11 points	Choose from the 11 focus points shown at right. Use for quick focus-point selection. 

a3: Built-in AF-assist Illuminator

MENU button →  Custom Settings menu

Choose whether the built-in AF-assist illuminator lights to assist the focus operation when lighting is poor. *AF-assist illuminator*









Option	Description
On	The AF-assist illuminator lights when lighting is poor (for more information, see page 252).
Off	The AF-assist illuminator does not light to assist the focus operation. The camera may not be able to focus using autofocus when lighting is poor.

a4: Rangefinder

MENU button →  Custom Settings menu

Choose **On** to use the exposure indicator to determine whether the camera is correctly focused in manual focus mode (□ 57; note that this function is not available in shooting mode **M**, when the exposure indicator instead shows whether the subject is correctly exposed).


Indicator	Description	Indicator	Description
	Subject in focus.		Focus point is slightly behind subject.
	Focus point is slightly in front of subject.		Focus point is well behind subject.
	Focus point is well in front of subject.		Camera can not determine correct focus.

Using the Electronic Rangefinder

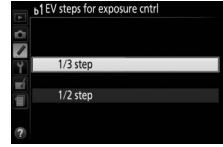
The electronic rangefinder requires a lens with a maximum aperture of f/5.6 or faster. The desired results may not be achieved in situations in which the camera would be unable to focus using autofocus (□ 52). The electronic rangefinder is not available during live view.

b: Exposure

b1: EV Steps for Exposure Cntrl

MENU button →  Custom Settings menu

Select the increments used when making adjustments to shutter speed, aperture, exposure and flash compensation, and bracketing.

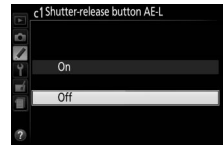


c: Timers/AE Lock

c1: Shutter-Release Button AE-L

MENU button →  Custom Settings menu



If **On** is selected, exposure will lock when the shutter-release button is pressed halfway.



c2: Auto off Timers

MENU button →  Custom Settings menu

This option determines how long the monitor remains on if no operations are performed during menu display and playback (**Playback/menus**), while photographs are displayed in the monitor after shooting (**Image review**), and during live view (**Live view**), and how long the standby timer, viewfinder, and information display remain on when no operations are performed (**Standby timer**). Choose shorter auto-off delays to reduce the drain on the battery.

Option	Description (all times are approximate)				
SHORT Short NORM Normal LONG Long	Auto off timers are set to the following values:				
		Playback/menus	Image review	Live view	Standby timer
	Short	20 s	4 s	5 min.	4 s
	Normal	1 min.	4 s	10 min.	8 s
Long	5 min.	20 s	20 min.	1 min.	
 Custom	Choose separate delays for Playback/menus , Image review , Live view , and Standby timer . When settings are complete, press  .				

Auto off Timers

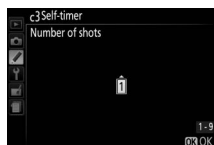
The monitor and viewfinder will not turn off automatically when the camera is connected to a computer or printer via USB.

c3: Self-Timer

MENU button → Custom Settings menu

Choose the length of the shutter release delay and the number of shots taken.

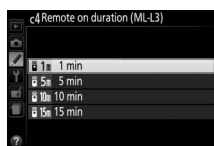
- **Self-timer delay:** Choose the length of the shutter-release delay.
- **Number of shots:** Press ▲ and ▼ to choose the number of shots taken each time the shutter-release button is pressed (from 1 to 9; if a value other than 1 is selected, shots will be taken at intervals of about 4 seconds).



c4: Remote on Duration (ML-L3)

MENU button → Custom Settings menu

Choose how long the camera will wait for a signal from the optional ML-L3 remote control before cancelling remote release mode. Choose shorter times for longer battery life. This setting applies only during viewfinder photography.



d: Shooting/Display

d1: Beep

MENU button → Custom Settings menu

Choose the pitch (**High** or **Low**) of the beep that sounds when the camera focuses and in self-timer and remote-control modes. Select **Off** to prevent the beep from sounding.

The current setting is shown in the information display: is displayed when the beep is on, when it is off.



d2: Viewfinder Grid Display

MENU button →  Custom Settings menu

Choose **On** to display on-demand grid lines in the viewfinder for reference when composing photographs (📖 4).

d3: ISO Display

MENU button →  Custom Settings menu

Select **On** to display ISO sensitivity in the viewfinder in place of the number of exposures remaining.

d4: File Number Sequence

MENU button →  Custom Settings menu

When a photograph is taken, the camera names the file by adding 1 to the last file number used. This option controls whether file numbering continues from the last number used when a new folder is created, the memory card is formatted, or a new memory card is inserted in the camera.

Option	Description
On	When a new folder is created, the memory card formatted, or a new memory card inserted in the camera, file numbering continues from the last number used. If a photograph is taken when the current folder contains a photograph numbered 9999, a new folder will be created automatically and file numbering will begin again from 0001.
Off	File numbering is reset to 0001 when a new folder is created, the memory card is formatted, or a new memory card is inserted in the camera. Note that a new folder is created automatically if a photograph is taken when the current folder contains 999 photographs.
Reset	Resets the file numbering for On to 0001 and creates a new folder with the next photograph taken.


File Number Sequence

If the current folder is numbered 999 and contains either 999 photographs or a photograph numbered 9999, the shutter-release button will be disabled and no further photographs can be taken. Choose **Reset** for Custom Setting d4 (**File number sequence**) and then either format the current memory card or insert a new memory card.

File Names

Photographs are stored as image files with names of the form “DSC_####.xxx,” where #### is a four-digit number between 0001 and 9999 assigned automatically in ascending order by the camera, and xxx is one of the following three-letter extensions: “NEF” for NEF (RAW) images, “JPG” for JPEG images, or “MOV” for movies. The NEF and JPEG files recorded at a setting of NEF (RAW)+JPEG have the same file names but different extensions. Copies created with image overlay (📄 211) and movie edit options (📄 131) have file names beginning with “DSC_”; copies created with the other options in the retouch menu have file names beginning with “CSC” (e.g., “CSC_0001.JPG”). Images recorded with the **Color space** option in the shooting menu set to **Adobe RGB** (📄 179) have names that begin with an underscore (e.g., “_DSC0001.JPG”).

d5: Exposure Delay Mode

MENU button →  Custom Settings menu

In situations where the slightest camera movement can blur pictures, select **On** to delay shutter release until about 1 s after the shutter-release button is pressed and the mirror is raised.

d6: Print Date

MENU button → Custom Settings menu

Choose the date information imprinted on photographs as they are taken. Date imprints can not be added to or removed from existing photos.

Option	Description
Off	The time and date do not appear on photographs.
DATE Date	The date or date and time are imprinted on photographs taken while this option is in effect. 15.10.2013
DATE Date and time	effect. 15.10.2013 10:02
Date counter	New photos are imprinted with a time stamp showing the number of days between the date of shooting and a selected date (see below).

At settings other than **Off**, the selected option is indicated by a **DATE** icon in the information display.

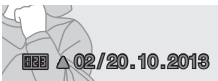


Print Date

The date is recorded in the order selected for **Time zone and date** (☐ 201). The imprinted data may be cropped out or rendered illegible in copies created when images are retouched (☐ 205). The date does not appear on NEF (RAW) or NEF (RAW)+JPEG images.

Date Counter

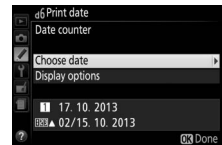
Pictures taken while this option is in effect are imprinted with the number of days remaining until a future date or the number of days elapsed since a past date. Use it to track the growth of a child or count down the days until a birthday or wedding.



Future date (two days remaining)



Past date (two days elapsed)



The camera offers three slots for storing dates.

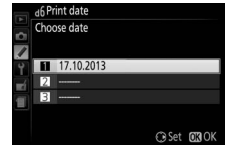
1 Enter the first date.

The first time you select **Date counter**, you will be prompted to enter a date for the first slot. Enter a date using the multi selector and press to exit to the date list.



2 Enter additional dates or edit existing dates.

To change a date or enter additional dates, highlight a slot, press ►, and enter a date as described above.



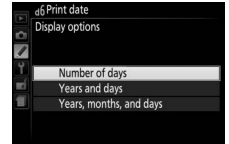
3 Choose a date.

Highlight a slot in the date list and press OK.



4 Choose a date counter format.

Highlight **Display options** and press ►, then highlight a date format and press OK.



5 Exit the date counter menu.

Press OK to exit the date counter menu.

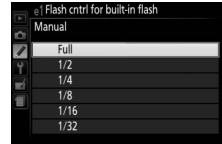
e: Bracketing/Flash

e1: Flash Cntrl for Built-in Flash

MENU button → Custom Settings menu

Choose the flash mode for the built-in flash in **P**, **S**, **A**, and **M** modes.

Option	Description
TTL TTL	Flash output is adjusted automatically in response to shooting conditions.
Manual	Choose a flash level. At full power, the built-in flash has a Guide Number of 13/43 (m/ft., ISO 100, 20 °C/68 °F).



Manual

A icon flashes in the viewfinder and flashes in the information display when **Manual** is selected and the flash is raised.



The SB-400 and SB-300

When an optional SB-400 or SB-300 flash unit is attached and turned on, **Flash cntrl for built-in flash** changes to **Optional flash**, allowing the flash control mode for the optional flash unit to be selected from **TTL** and **Manual**.

TTL Flash Control

The following types of flash control are supported when a CPU lens is used in combination with the built-in flash (□ 62) or optional flash units (□ 232).

- **i-TTL Balanced Fill-Flash for Digital SLR:** Information from the 2016-pixel RGB sensor is used to adjust flash output for a natural balance between the main subject and the background.
- **Standard i-TTL Fill-Flash for Digital SLR:** Flash output is adjusted for the main subject; the brightness of the background is not taken into account.

Standard i-TTL flash control is used with spot metering or when selected with the optional flash unit. i-TTL balanced fill-flash for digital SLR is used in all other cases.


e2: Auto Bracketing Set

MENU button → Custom Settings menu

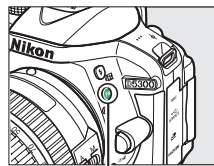
Choose the setting (exposure, white balance, or Active D-Lighting) varied when bracketing is in effect (□ 108).

f: Controls










f1: Assign Fn Button

MENU button →  Custom Settings menu

Choose the role played by the **Fn** button.














Fn button

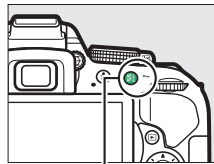
Option	Description
QUAL Image quality/size	Keeping the Fn button pressed, rotate the command dial to select image quality and size (□ 59).
ISO ISO sensitivity	Keeping the Fn button pressed, rotate the command dial to select ISO sensitivity (□ 67).
WB White balance	Keeping the Fn button pressed, rotate the command dial to select white balance (P , S , A , and M modes only; □ 101).
 Active D-Lighting	Keeping the Fn button pressed, rotate the command dial to select Active D-Lighting (P , S , A , and M modes only; □ 94).
HDR HDR	Keeping the Fn button pressed, rotate the command dial to adjust HDR settings (P , S , A , and M modes only; □ 96).
+RAW +NEF (RAW)	If image quality is set to JPEG fine , JPEG normal , or JPEG basic , an NEF (RAW) copy will be recorded with the next picture taken after the Fn button is pressed. To exit without recording an NEF (RAW) copy, press the Fn button again. This option has no effect in the following special effects modes:  ,  ,  ,  ,  , and  .
BKT Auto bracketing	Keeping the Fn button pressed, rotate the command dial to choose the bracketing increment (exposure and white balance bracketing) or to turn ADL bracketing on or off (P , S , A , and M modes only; □ 108).
[+] AF-area mode	Keeping the Fn button pressed, rotate the command dial to choose an AF-area mode (□ 53).
 Viewfinder grid display	Press the Fn button to display or hide the viewfinder framing grid. <div data-bbox="823 1104 1037 1267" data-label="Image"> </div>
 Wi-Fi	Press the Fn button to display the Wi-Fi menu (□ 169).


f2: Assign AE-L/AF-L Button

MENU button →  Custom Settings menu

Choose the role played by the  (AE-L) button.



Option	Description
 AE/AF lock	Focus and exposure lock while the  (AE-L) button is pressed.
 AE lock only	Exposure locks while the  (AE-L) button is pressed.
 AE lock (Hold)	Exposure locks when the  (AE-L) button is pressed, and remains locked until the button is pressed a second time or the standby timer expires.
 AF lock only	Focus locks while the  (AE-L) button is pressed.
 AF-ON	The  (AE-L) button initiates autofocus. The shutter-release button can not be used to focus.

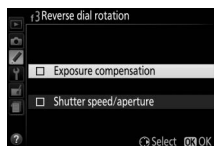


 (AE-L) button

f3: Reverse Dial Rotation

MENU button →  Custom Settings menu

Reverse the direction of rotation of the command dial when they are used to make adjustments to exposure or flash compensation (**Exposure compensation**) and/or shutter speed and aperture (**Shutter speed/aperture**). Highlight options and press  to select or deselect, then press .









f4: Slot Empty Release Lock

MENU button →  Custom Settings menu

If **Release locked** is selected, the shutter-release button is only enabled when a memory card is inserted in the camera. Selecting **Enable release** allows the shutter to be released when no memory card is inserted, although no pictures will be recorded (they will however be displayed in the monitor in demo mode).

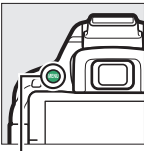
f5: Reverse Indicators

MENU button →  Custom Settings menu

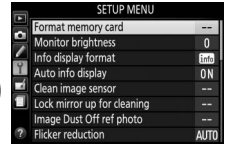
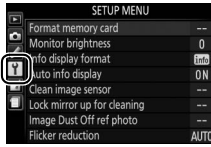
If    (+0-) is selected, the exposure indicators in the viewfinder and information display are displayed with positive values on the left and negative values on the right. Select    (-0+) to display negative values on the left and positive values on the right.

Y The Setup Menu: *Camera Setup*

To display the setup menu, press **MENU** and select the **Y** (setup menu) tab.



MENU button



The setup menu contains the following options:

Option	Default	📖
Format memory card	—	196
Monitor brightness	0	196
Info display format		
AUTO/SCENE/EFFECTS	Graphic design	197
P/S/A/M	Graphic design	
Auto info display	On	199
Clean image sensor		
Clean at startup/shutdown	Clean at startup & shutdown	241
Lock mirror up for cleaning ¹	—	243
Image Dust Off ref photo	—	199
Flicker reduction	Auto	200
Time zone and date ²		
Daylight saving time	Off	201
Language ²	—	201
Auto image rotation	On	202
Image comment	—	202
Location data		
Record location data	Off	74
GPS options	—	
Create log	—	
Log list	—	

Option	Default	📖
Video mode ²	—	202
HDMI		
Output resolution	Auto	166
Device control	On	
Remote control		
Remote shutter release	Take photos	203
Assign Fn button	Same as camera Fn button	
Wi-Fi		
Network connection	Disable	169
Network settings	—	
Eye-Fi upload ³	Enable	204
Conformity marking	—	204
Firmware version	—	204

1 Not available when battery is low.

2 Default varies with country of purchase.

3 Only available when compatible Eye-Fi memory card is inserted (📖 204).

Note: Depending on camera settings, some items may be grayed out and unavailable.

Format Memory Card

MENU button →  setup menu

Memory cards must be formatted before first use or after being formatted in other devices. Format the card as described below.

Formatting Memory Cards

Formatting memory cards permanently deletes any data they may contain. Be sure to copy any photographs and other data you wish to keep to a computer before proceeding (📖 153).

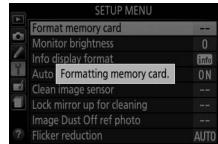
1 Highlight Yes.

To exit without formatting the memory card, highlight **No** and press .






2 Press .

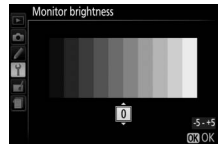
A message will be displayed while the card is formatted. *Do not remove the memory card or remove or disconnect the power source until formatting is complete.*




Monitor Brightness

MENU button →  setup menu

Press  or  to choose monitor brightness. Choose higher values for increased brightness, lower values for reduced brightness.



Info Display Format

MENU button →  setup menu

Choose an information display format (📄 6). Formats can be chosen separately for auto, scene, and special effects modes and for **P**, **S**, **A**, and **M** modes.



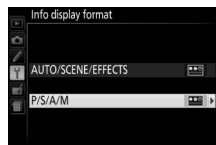
Classic (📄 198)




Graphic (📄 6)

1 Select a shooting mode option.

Highlight **AUTO/SCENE/EFFECTS** or **P/S/A/M** and press .

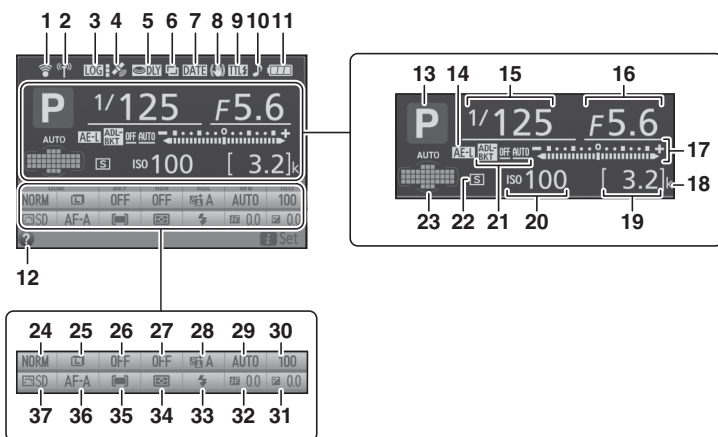


2 Select a design.

Highlight a design and press .



The “Classic” display is shown below.



1 Eye-Fi connection indicator..... 204	14 Autoexposure (AE) lock indicator 91	24 Image quality 59
2 Wi-Fi connection indicator..... 172	15 Shutter speed 83	25 Image size 61
3 Track log indicator 77	16 Aperture (f-number) 83	26 Bracketing increment 109
4 Satellite signal indicator..... 75	17 Exposure indicator 87	27 HDR (High Dynamic Range) 96
5 Exposure delay mode 189	Exposure compensation indicator 92	28 Active D-Lighting 94
6 Multiple exposure indicator..... 100	Bracketing progress indicator 110	29 White balance 101
7 Print date indicator..... 190	18 “k” (appears when memory remains for over 1000 exposures)..... 15	30 ISO sensitivity..... 67
8 Vibration reduction indicator 18, 181	19 Number of exposures remaining..... 15	31 Exposure compensation..... 92
9 Flash control indicator 192	White balance recording indicator 104	32 Flash compensation 93
Flash compensation indicator for optional flash units ... 235	Capture mode indicator	33 Flash mode 63
10 “Beep” indicator 187	20 ISO sensitivity 67	34 Metering..... 90
11 Battery indicator 17	Auto ISO sensitivity indicator 180	35 AF-area mode 53, 120
12 Help icon 8, 256	21 Bracketing indicator 108	36 Focus mode 51, 119
13 Shooting mode	ADL bracketing amount ... 110	37 Picture Control 111
AUTO auto/ auto (flash off)..... 19	22 Release mode 45	
Scene modes..... 30	23 Auto-area AF indicator 53	
Special effects mode..... 37	3D-tracking indicator 53	
P, S, A, and M modes..... 82	Focus point..... 55	

Note: Display shown with all indicators lit for illustrative purposes.



If **On** is selected, the information display will appear after the shutter-release button is pressed halfway. If **Off** is selected, the information display can be viewed by pressing the  button.

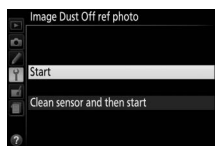
Image Dust Off Ref Photo

Acquire reference data for the Image Dust Off option in Capture NX 2 (available separately; for more information, see the Capture NX 2 manual).

Image Dust Off ref photo is available only when a CPU lens is mounted on the camera. A lens with a focal length of at least 50 mm is recommended. When using a zoom lens, zoom all the way in.

1 Choose a start option.

Highlight one of the following options and press . To exit without acquiring image dust off data, press MENU.



- **Start:** The message shown at right will be displayed and “rEF” will appear in the viewfinder.
- **Clean sensor and then start:** Select this option to clean the image sensor before starting. The message shown at right will be displayed and “rEF” will appear in the viewfinder when cleaning is complete.

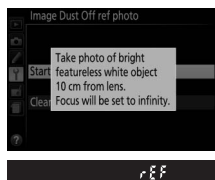


Image Sensor Cleaning

Image Dust Off reference data recorded before image sensor cleaning is performed can not be used with photographs taken after image sensor cleaning is performed. Select **Clean sensor and then start** only if the Image Dust Off reference data will not be used with existing photographs.

2 Frame a featureless white object in the viewfinder.

With the lens about ten centimeters (four inches) from a well-lit, featureless white object, frame the object so that it fills the viewfinder and then press the shutter-release button halfway.

In autofocus mode, focus will automatically be set to infinity; in manual focus mode, set focus to infinity manually.

3 Acquire Image Dust Off reference data.

Press the shutter-release button the rest of the way down to acquire Image Dust Off reference data.

If the reference object is too bright or too dark, the camera may be unable to acquire Image Dust Off reference data and the message shown at right will be displayed. Choose another reference object and repeat the process from step 1.



✓ Image Dust Off Reference Data

The same reference data can be used for photographs taken with different lenses or at different apertures. Reference images can not be viewed using computer imaging software. A grid pattern is displayed when reference images are viewed on the camera.



Flicker Reduction


MENU button → Y setup menu

Reduce flicker and banding when shooting under fluorescent or mercury-vapor lighting during live view (☞ 118) or movie recording (☞ 126). Choose **Auto** to allow the camera to automatically choose the correct frequency, or manually match the frequency to that of the local AC power supply.

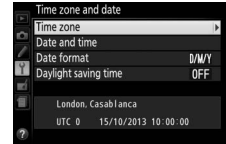
✓ Flicker Reduction


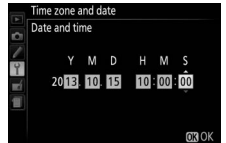
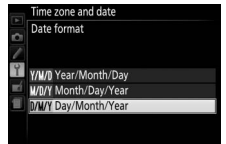
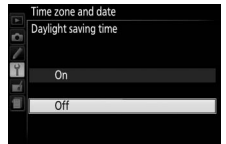
If **Auto** fails to produce the desired results and you are unsure as to the frequency of the local power supply, test both options and choose the one that produces the best results. Flicker reduction may not produce the desired results if the subject is very bright, in which case you should select mode **A** or **M** and choose a smaller aperture (higher f-number) before starting live view. Note that flicker reduction is not available when **On** is selected for **Movie settings** > **Manual movie settings** (☞ 129) in mode **M**.

Time Zone and Date


MENU button →  setup menu

Change time zones, set the camera clock, choose the date display order, and turn daylight saving time on or off.




Option	Description	
Time zone	Choose a time zone. The camera clock is automatically set to the time in the new time zone.	 A screenshot of the 'Time zone' menu. It features a world map with left and right navigation arrows. Below the map, it shows 'London, Casablanca' and 'UTC 0 15/10/2013 10:00:00'.
Date and time	Set the camera clock (🕒 15).	 A screenshot of the 'Date and time' menu. It shows the date '2013 10 15' and the time '10:00:00' with individual digit selection options.
Date format	Choose the order in which the day, month, and year are displayed.	 A screenshot of the 'Date format' menu. It lists three options: 'Y/M/D Year/Month/Day', 'M/D/Y Month/Day/Year', and 'D/M/Y Day/Month/Year'.
Daylight saving time	Turn daylight saving time on or off. The camera clock will automatically be advanced or set back one hour.	 A screenshot of the 'Daylight saving time' menu. It shows two options: 'On' and 'Off'.

Language

MENU button →  setup menu

Choose a language for camera menus and messages.

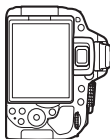
Auto Image Rotation

MENU button →  setup menu

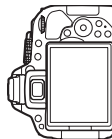
Photographs taken while **On** is selected contain information on camera orientation, allowing them to be rotated automatically during playback or when viewed in ViewNX 2 or Capture NX 2 (available separately). The following orientations are recorded:



Landscape (wide) orientation



Camera rotated 90° clockwise




Camera rotated 90° counterclockwise

Camera orientation is not recorded when **Off** is selected. Choose this option when panning or taking photographs with the lens pointing up or down.

Rotate Tall

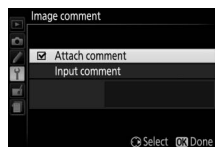
To automatically rotate “tall” (portrait-orientation) photographs for display during playback, select **On** for the **Rotate tall** option in the playback menu (☰ 176).

Image Comment

MENU button →  setup menu

Add a comment to new photographs as they are taken. Comments can be viewed as metadata in ViewNX 2 (supplied) or Capture NX 2 (available separately; ☰ 236). The comment is also visible on the shooting data page in the photo information display (☰ 138). The following options are available:

- **Input comment:** Input a comment as described on page 116. Comments can be up to 36 characters long.
- **Attach comment:** Select this option to attach the comment to all subsequent photographs. **Attach comment** can be turned on and off by highlighting it and pressing **▶**. After choosing the desired setting, press **OK** to exit.



Video Mode



MENU button →  setup menu

When connecting the camera to a television or VCR, be sure the camera video mode matches the device video standard (NTSC or PAL).

Choose the functions performed using a remote cord or wireless remote controller.






■ Remote Shutter Release

Choose whether the shutter-release button on the optional accessory is used for photography or movie recording.


Option	Description
 Take photos	The shutter-release button on the optional accessory is used to take photographs.
 Record movies	The shutter-release button on the optional accessory is used for movie recording. Press the button halfway to start live view or to focus in AF-S and AF-F modes. Press the button all the way down to start or end recording. Use the camera live view switch to end live view.

■ Assign Fn button

Choose the role played by the **Fn** buttons on wireless remote controllers.

Option	Description
 Same as camera  button	The Fn button on the wireless remote controller performs the function currently assigned to the camera  () button (194).
 Live view	The Fn button on the wireless remote controller can be used to start and end live view.






Eye-Fi Upload

MENU button →  setup menu

This option is displayed only when an Eye-Fi memory card (available separately from third-party suppliers) is inserted in the camera. Choose **Enable** to upload photographs to a preselected destination. Note that pictures will not be uploaded if signal strength is insufficient.


Observe all local laws concerning wireless devices and choose **Disable** where wireless devices are prohibited.

When an Eye-Fi card is inserted, its status is indicated by an icon in the information display:

- : Eye-Fi upload disabled.
- : Eye-Fi upload enabled but no pictures available for upload.
-  (static): Eye-Fi upload enabled; waiting to begin upload.
-  (animated): Eye-Fi upload enabled; uploading data.
- : Error.



Eye-Fi Cards


Whether due to errors or other causes, Eye-Fi cards may emit wireless signals when **Disable** is selected. If a warning is displayed in the monitor ( 256), turn the camera off and remove the card.

The camera can be used to turn Eye-Fi cards on and off, but may not support other Eye-Fi functions. Be sure to keep the card firmware updated. See the documentation provided with the Eye-Fi card for more information; for information on the availability of Eye-Fi cards in your country or region, contact the manufacturer.

Using Eye-Fi Cards in Ad Hoc Mode


Additional time may be required when connecting using Eye-Fi cards that support ad hoc mode. Select longer values for **Auto off timers** > **Standby timer** in the setup menu ( 186).

Conformity Marking

MENU button →  setup menu

View the standards with which the camera complies.

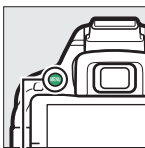
Firmware Version

MENU button →  setup menu

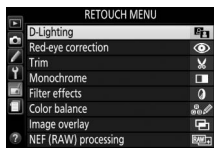
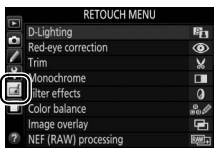
View the current camera firmware version.

The Retouch Menu: Creating Retouched Copies





















To display the retouch menu, press **MENU** and select the  (retouch menu) tab.



MENU button



The retouch menu is used to create trimmed or retouched copies of the photographs on the memory card, and is only available when a memory card containing photographs is inserted in the camera.

Option		Option		Option	
 D-Lighting	207	 NEF (RAW) processing	213	 Color sketch	216
 Red-eye correction	207	 Resize	214	 Perspective control	217
 Trim	208	 Quick retouch	215	 Miniature effect	218
 Monochrome	208	 Straighten	215	 Selective color	219
 Filter effects	209	 Distortion control	215	 Edit movie	131
 Color balance	210	 Fisheye	216	 Side-by-side comparison*	221
 Image overlay	211	 Color outline	216		

* Available only if retouch menu is displayed by pressing **i** and selecting **Retouch** in full-frame playback when a retouched image or original is displayed.

Retouching Copies

Most options can be applied to copies created using other retouch options, although with the exceptions of **Image overlay** and **Edit movie > Choose start/end point**, each option can be applied only once (note that multiple edits may result in loss of detail). Options that can not be applied to the current image are grayed out and unavailable.

Image Quality and Size

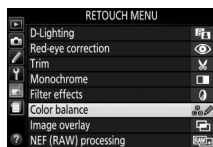
Except in the case of copies created with **Trim** and **Resize**, copies created from JPEG images are the same size and quality as the original, while copies created from NEF (RAW) photos are saved as large fine-quality JPEG images.

Creating Retouched Copies

To create a retouched copy:

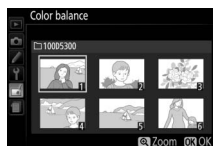
1 Display retouch options.

Highlight the desired item in the retouch menu and press ►.



2 Select a picture.

Highlight a picture and press **OK** (to view the highlighted picture full screen, press and hold the **Q** button).



Retouch


The camera may not be able to display or retouch images created with other devices. If the image was recorded at image quality settings of NEF (RAW) + JPEG (□ 59), retouch options apply only to the RAW copy.

3 Select retouch options.

For more information, see the section for the selected item. To exit without creating a retouched copy, press **MENU**.



4 Create a retouched copy.

Press **OK** to create a retouched copy. Except in the photo information "image only" page (□ 136), retouched copies are indicated by a  icon.



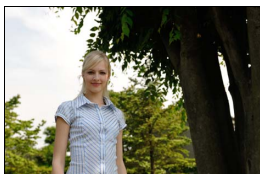
Creating Retouched Copies During Playback

To create a retouched copy of the picture currently displayed in full-frame playback (□ 135), press **i**, then highlight **Retouch** and press **OK** and select a retouch option (**Image overlay** excluded).

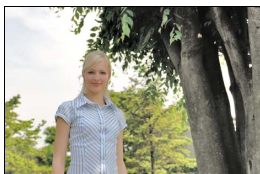
D-Lighting

MENU button →  retouch menu

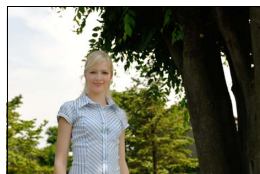
D-Lighting brightens shadows, making it ideal for dark or backlit photographs.



Before



D-Lighting




*D-Lighting
(portrait subject)*

Press ◀ or ▶ to choose the amount of correction performed; the effect can be previewed in the edit display. Press ⊗ to copy the photograph.

■ Portrait Subjects

Select **Portrait subjects** to restrict D-Lighting to portrait subjects.

Portrait Subjects

The camera automatically selects up to three subjects for portrait D-Lighting (note that portrait D-Lighting can not be applied to photos taken with **Off** selected for **Auto image rotation** in the setup menu;  202). Depending on composition and how the subjects are posed, the desired results may not be achieved; if you are not satisfied, remove the check from **Portrait subjects**.

Red-Eye Correction

MENU button →  retouch menu

This option is used to correct “red-eye” caused by the flash, and is available only with photographs taken using the flash. The photograph selected for red-eye correction can be previewed in the edit display. Confirm the effects of red-eye correction and press ⊗ to create a copy. Note that red-eye correction may not always produce the expected results and may in very rare circumstances be applied to portions of the image that are not affected by red-eye; check the preview thoroughly before proceeding.

Trim

MENU button →  retouch menu

Create a cropped copy of the selected photograph. The selected photograph is displayed with the selected crop shown in yellow; create a cropped copy as described in the following table.










To	Use	Description
Increase size of crop		Press the  button to increase the size of the crop.
Reduce size of crop		Press the  (?) button to reduce the size of the crop.
Change crop aspect ratio		Rotate the command dial to switch between aspect ratios of 3 : 2, 4 : 3, 5 : 4, 1 : 1, and 16 : 9.
Move crop		Use multi selector to position the crop.
Create copy		Save the current crop as a separate file.

Image Size

The size of the copy (which varies with crop size and aspect ratio) appears at upper left in the crop display.

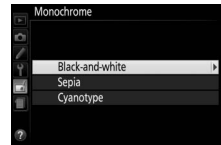
Viewing Cropped Copies




Playback zoom may not be available when cropped copies are displayed.

Monochrome

MENU button →  retouch menu

Copy photographs in **Black-and-white**, **Sepia**, or **Cyanotype** (blue and white monochrome).



Selecting **Sepia** or **Cyanotype** displays a preview of the selected image; press  to increase color saturation,  to decrease. Press  to create a monochrome copy.

Increase saturation





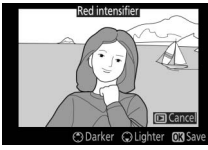
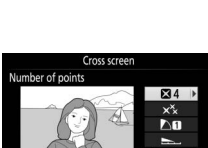

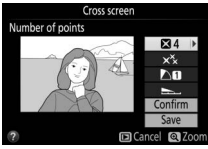
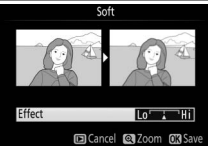
Decrease saturation



Filter Effects


MENU button →  retouch menu

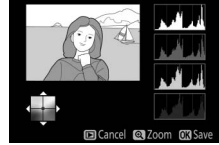
After adjusting filter effects as described below, press  to copy the photograph.

Option	Description	
Skylight	Creates the effect of a skylight filter, making the picture less blue.	
Warm filter	Creates a copy with warm tone filter effects, giving the copy a “warm” red cast.	
Red intensifier	Intensify reds (Red intensifier), greens (Green intensifier), or blues (Blue intensifier). Press ▲ to increase the effect, ▼ to decrease.	
Green intensifier		
Blue intensifier		
Cross screen	<p>Add starburst effects to light sources.</p> <ul style="list-style-type: none"> • Number of points: Choose from four, six, or eight. • Filter amount: Choose the brightness of the light sources affected. • Filter angle: Choose the angle of the points. • Length of points: Choose the length of points. • Confirm: Preview the effects of the filter. Press  to preview the copy full frame. • Save: Create a retouched copy. 	
Soft	Add a soft filter effect. Press ◀ or ▶ to choose the filter strength.	

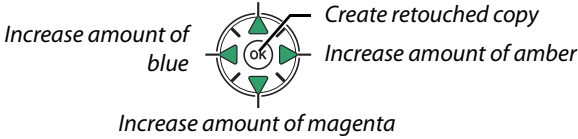
Color Balance

MENU button →  retouch menu

Use the multi selector to create a copy with modified color balance as shown below. Red, green, and blue histograms ( 137) show the distribution of tones in the copy.



Increase amount of green



Zoom






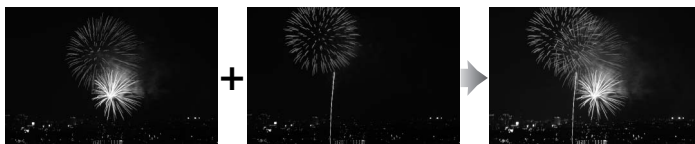
To zoom in on the image displayed in the monitor, press the  button. The histogram will be updated to show data only for the portion of the image displayed in the monitor. While the image is zoomed in, press the  () button to toggle back and forth between color balance and zoom. When zoom is selected, you can zoom in and out with the  and  (?) buttons and scroll the image with the multi selector.

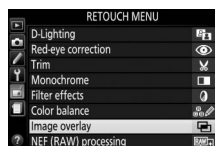


Image overlay combines two existing NEF (RAW) photographs to create a single picture that is saved separately from the originals; the results, which make use of RAW data from the camera image sensor, are noticeably better than overlays created in an imaging application. The new picture is saved at current image quality and size settings; before creating an overlay, set image quality and size (☞ 59, 61; all options are available). To create an NEF (RAW) copy, choose an image quality of **NEF (RAW)**.

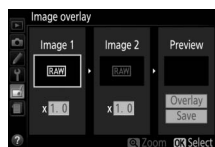


1 Select Image overlay.

Highlight **Image overlay** in the retouch menu and press **▶**.



The dialog shown at right will be displayed, with **Image 1** highlighted; press **OK** to display a list of the NEF (RAW) pictures created with this camera.



2 Select the first image.

Use the multi selector to highlight the first photograph in the overlay. To view the highlighted photograph full frame, press and hold the **Q** button. Press **OK** to select the highlighted photograph and return to the preview display.



3 Select the second image.

The selected image will appear as **Image 1**. Highlight **Image 2** and press **OK**, then select the second photo as described in Step 2.

4 Adjust gain.

Highlight **Image 1** or **Image 2** and optimize exposure for the overlay by pressing **▲** or **▼** to select gain from values between 0.1 and 2.0. Repeat for the second image. The default value is 1.0; select 0.5 to halve gain or 2.0 to double it. The effects of gain are visible in the **Preview** column.



5 Preview the overlay.

Press **◀** or **▶** to place the cursor in the **Preview** column and press **▲** or **▼** to highlight **Overlay**. Press **OK** to preview the overlay as shown at right (to save the overlay without displaying a preview, select **Save**). To return to Step 4 and select new photos or adjust gain, press **Q** (?).



6 Save the overlay.

Press **OK** while the preview is displayed to save the overlay. After an overlay is created, the resulting image will be displayed full-frame in the monitor.

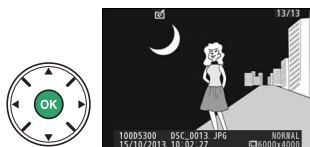


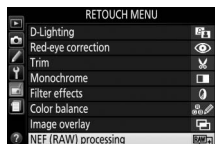
Image Overlay

Only NEF (RAW) photographs with the same bit depth can be combined (178). The overlay has the same photo info as the photograph selected for **Image 1**.

Create JPEG copies of NEF (RAW) photographs.

1 Select NEF (RAW) processing.

Highlight **NEF (RAW) processing** in the retouch menu and press **▶** to display a picture selection dialog listing only NEF (RAW) images created with this camera.



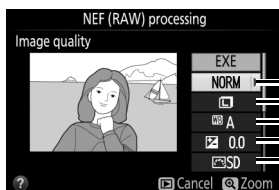
2 Select a photograph.

Use the multi selector to highlight a photograph (to view the highlighted photograph full frame, press and hold the **Q** button). Press **OK** to select the highlighted photograph and proceed to the next step.

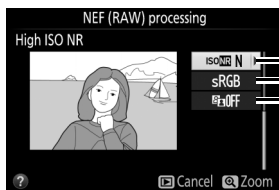


3 Adjust NEF (RAW) processing settings.

Adjust the settings listed below. Note that white balance is not available with pictures created with multiple exposure or image overlay, and that the effects of exposure compensation may differ from those that might have been expected when the photograph was taken.



- Image quality (□ 59)
- Image size (□ 61)
- White balance (□ 101)
- Exposure compensation (□ 92)
- Picture Control (□ 111)



- High ISO NR (□ 180)
- Color space (□ 179)
- D-Lighting (□ 207)

4 Copy the photograph.

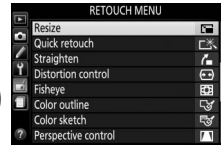
Highlight **EXE** and press **OK** to create a JPEG copy of the selected photograph. To exit without copying the photograph, press the **MENU** button.



Create small copies of one or more selected photographs.

1 Select Resize.

Highlight **Resize** in the retouch menu and press



2 Choose a size.

Highlight **Choose size** and press

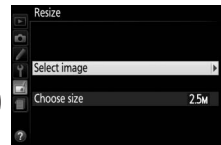


Highlight an option and press



3 Choose pictures.

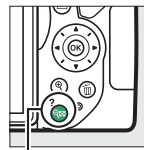
Highlight **Select image** and press



Highlight pictures using the multi selector and press the (?) button to select or deselect (to view the highlighted picture full screen, press and hold the button).

Selected pictures are marked by a icon.

Press when the selection is complete.



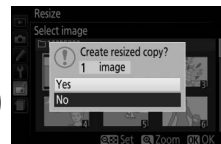
(?) button



4 Save the resized copies.

A confirmation dialog will be displayed.

Highlight **Yes** and press to save the resized copies.



Viewing Resized Copies

Playback zoom may not be available when resized copies are displayed.

Quick Retouch

MENU button →  retouch menu

Create copies with enhanced saturation and contrast. D-Lighting is applied as required to brighten dark or backlit subjects.

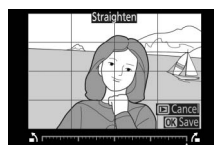
Press ◀ or ▶ to choose the amount of enhancement. Press Ⓞ to copy the photograph.



Straighten

MENU button →  retouch menu

Create a straightened copy of the selected image. Press ▶ to rotate the image clockwise by up to five degrees in increments of approximately 0.25 degrees, ◀ to rotate it counterclockwise (note that edges of the image will be trimmed to create a rectangular copy). Press Ⓞ to save the retouched copy.



Distortion Control

MENU button →  retouch menu

Create copies with reduced peripheral distortion. Select **Auto** to let the camera correct distortion automatically and then make fine adjustments using the multi selector, or select **Manual** to reduce distortion manually (note that **Auto** is not available with photos taken using auto distortion control; see page 179).



Press ▶ to reduce barrel distortion, ◀ to reduce pin-cushion distortion (note that greater amounts of distortion control result in more of the edges being cropped out). Press Ⓞ to save the retouched copy.

Auto

Auto is for use only with pictures taken with type G, E, and D lenses (PC, fisheye, and certain other lenses excluded); results are not guaranteed with other lenses.

Fisheye

MENU button →  retouch menu

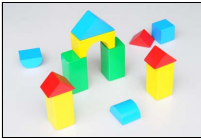
Create copies that appear to have been taken with a fisheye lens. Press ► to increase the effect (this also increases the amount that will be cropped out at the edges of the image), ◀ to reduce it. Press Ⓚ to save the retouched copy.



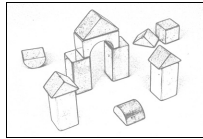
Color Outline

MENU button →  retouch menu

Create an outline copy of a photograph to use as a base for painting. Press Ⓚ to save the retouched copy.



Before



After



Color Sketch

MENU button →  retouch menu

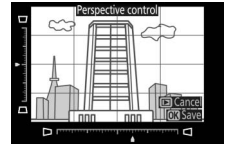
Create a copy of a photograph that resembles a sketch made with colored pencils. Press ▲ or ▼ to highlight **Vividness** or **Outlines** and press ◀ or ► to change. Vividness can be increased to make colors more saturated, or decreased for a washed-out, monochromatic effect, while outlines can be made thicker or thinner. Thicker outlines make colors more saturated. Press Ⓚ to save the retouched copy.



Perspective Control

MENU button →  retouch menu

Create copies that reduce the effects of perspective taken from the base of a tall object. Use the multi selector to adjust perspective (note that greater amounts of perspective control result in more of the edges being cropped out). Press **OK** to save the retouched copy.



Before










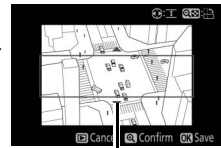
After

Miniature Effect

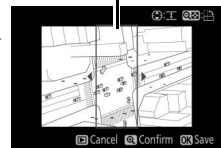
MENU button →  retouch menu

Create a copy that appears to be a photo of a diorama. Works best with photos taken from a high vantage point. The area that will be in focus in the copy is indicated by a yellow frame.

To	Press	Description
Choose orientation	 (?)	Press  (?) to choose orientation of area that is in focus.
Choose area in focus		If area of effect is in wide orientation, press ▲ or ▼ to position frame showing area of copy that will be in focus.
		If area of effect is in tall orientation, press ◀ or ▶ to position frame showing area of copy that will be in focus.
Choose size		If area of effect is in wide orientation, press ◀ or ▶ to choose height.
		If area of effect is in tall orientation, press ▲ or ▼ to choose width.
Create copy		Create copy.



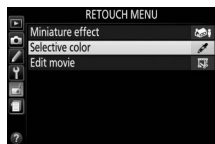
Area in focus



Create a copy in which only selected hues appear in color.

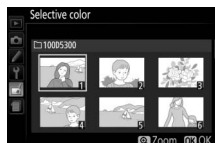
1 Select Selective color.

Highlight **Selective color** in the retouch menu and press ►.



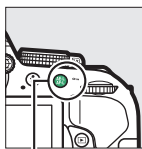
2 Select a photograph.

Highlight a photograph and press (to view the highlighted photograph full frame, press and hold the button).



3 Select a color.

Use the multi selector to position the cursor over an object and press (O-m) to select the color of the object as one that will remain in the final copy (the camera may have difficulty detecting unsaturated colors; choose a saturated color). To zoom in on the picture for precise color selection, press . Press (?) to zoom out.



(O-m) button

Selected color



4 Highlight the color range.

Rotate the command dial to highlight the color range for the selected color.



Color range





5 Choose the color range.

Press ▲ or ▼ to increase or decrease the range of similar hues that will be included in the final photograph. Choose from values between 1 and 7; note that higher values may include hues from other colors.




6 Select additional colors.

To select additional colors, rotate the command dial to highlight another of the three color boxes at the top of the display and repeat Steps 3–5 to select another color. Repeat for a third color if desired. To deselect the highlighted color, press  (To remove all colors, press and hold . A confirmation dialog will be displayed; select **Yes**).



7 Save the edited copy.


Press  to copy the photograph.

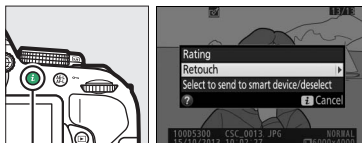


Side-by-side Comparison

Compare retouched copies to the original photographs. This option is only available if the retouch menu is displayed by pressing the **i** button and selecting **Retouch** when a copy or original is played back full frame.

1 Select a picture.

Select a retouched copy (shown by a  icon) or a photograph that has been retouched in full-frame playback. Press **i**, then highlight **Retouch** and press **OK**.



i button

2 Select Side-by-side comparison.

Highlight **Side-by-side comparison** in the retouch menu and press **OK**.

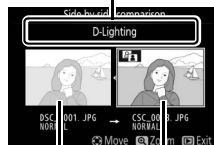


3 Compare the copy with the original.

The source image is displayed on the left, the retouched copy on the right, with the options used to create the copy listed at the top of the display. Press **◀** or **▶** to switch between the source image and the retouched copy. To view the highlighted picture full frame, press and hold the **Q** button. If the copy was created from two images using **Image overlay**, press **▲** or **▼** to view the other source image. If multiple copies exist for the current source image, press **▲** or **▼** to view the other copies. Press **OK** to return to playback with the highlighted image displayed.




Options used to create copy





Source image Retouched copy

Side-by-side comparison

The source image will not be displayed if the copy was created from a photograph that has since been deleted or that was protected when the copy was made ( 143).

Recent Settings / My Menu

Both recent settings, a menu listing the 20 most recently used settings, and My Menu, a custom menu listing up to 20 user-selected options, can be accessed by pressing the **MENU** button highlighting the last tab in the menu list (either  or .



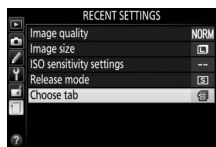
MENU button

Choosing a Menu




Use the **Choose tab** option to choose the menu displayed.

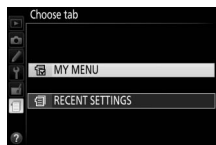
1 Select Choose tab.

Highlight **Choose tab** and press .







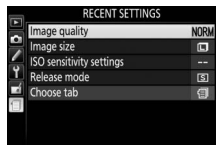
2 Select a menu.

Highlight  **MY MENU** or  **RECENT SETTINGS** and press  to display the selected menu.





Recent Settings


When  **RECENT SETTINGS** is selected for **Choose tab**, the menu lists the 20 most recently used settings, with the most recently-used items first. Press  or  to highlight an option and press  to select.



Removing Items from the Recent Settings Menu

To remove an item from the recent settings menu, highlight it and press the  button. A confirmation dialog will be displayed; press  again to delete the selected item.

My Menu

Selecting  **MY MENU** for **Choose tab** lets you access a customized menu of up to 20 options selected from the playback, shooting, Custom Settings, setup, and retouch menus. Follow the steps below to add items to, delete items from, and reorder items in My Menu.


■ Adding Options to My Menu

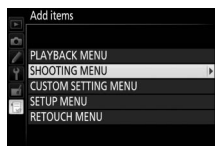
1 Select Add items.

Highlight **Add items** and press .




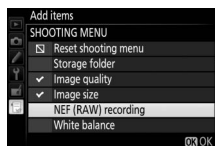
2 Select a menu.

Highlight the name of the menu containing the option you wish to add and press .






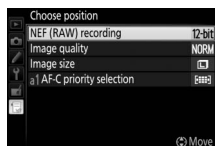
3 Select an item.

Highlight the desired menu item and press .




4 Position the new item.

Press  or  to move the new item up or down in My Menu. Press  to add the new item. Repeat steps 1–4 to select additional items.



Adding Options to My Menu

The items currently displayed in My Menu are indicated by a check mark. Items indicated by a  icon can not be selected.



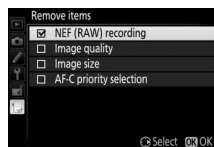
■ ■ Deleting Options from My Menu

1 Select Remove items.

Highlight **Remove items** and press ►.

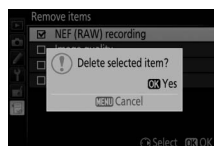
2 Select items.

Highlight items and press ► to select or deselect. Selected items are indicated by a check mark.



3 Delete the selected items.

Press **OK**. A confirmation dialog will be displayed; press **OK** again to delete the selected items.



■ Reordering Options in My Menu

1 Select Rank items.

Highlight **Rank items** and press ►.

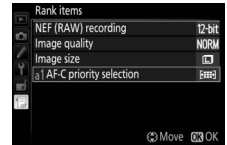
2 Select an item.

Highlight the item you wish to move and press **OK**.



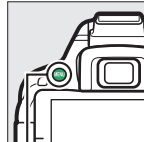
3 Position the item.

Press ▲ or ▼ to move the item up or down in My Menu and press **OK**. Repeat Steps 2–3 to reposition additional items.

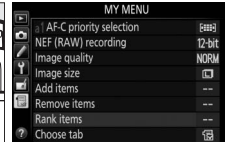


4 Exit to My Menu.

Press the **MENU** button to return to My Menu.



MENU button







Technical Notes



Read this chapter for information on compatible accessories, cleaning and storing the camera, and what to do if an error message is displayed or you encounter problems using the camera.

Compatible Lenses

Compatible CPU Lenses

This camera supports autofocus with AF-S, AF-P, and AF-I CPU lenses only. AF-S lenses have names beginning with **AF-S**, AF-P lenses with **AF-P**, and AF-I lenses with **AF-I**. Autofocus is not supported with other autofocus (AF) lenses. The following table lists the features available with compatible lenses in viewfinder photography:

Lens/accessory	Camera setting		Focus			Mode		Metering		
	AF	MF (with electronic rangefinder)	MF	M	Other modes	 		 		
						3D	Color	3D	Color	
AF-S, AF-P, AF-I NIKKOR	✓	✓	✓	✓	✓	✓	—	✓ ¹		
Other type G or D AF NIKKOR	—	✓	✓	✓	✓	✓	—	✓ ¹		
PC-E NIKKOR series ^{2,3}	—	✓ ⁴	✓	✓	✓	✓	—	✓ ¹		
PC Micro 85mm f/2.8D ⁵	—	✓ ⁴	✓	✓	—	✓	—	✓ ¹		
AF-S/AF-I teleconverter	✓ ⁶	✓ ⁶	✓	✓	✓	✓	—	✓ ¹		
Other AF NIKKOR (except lenses for F3AF)	—	✓ ⁷	✓	✓	✓	—	✓	✓ ¹		
AI-P NIKKOR	—	✓ ⁸	✓	✓	✓	—	✓	✓ ¹		

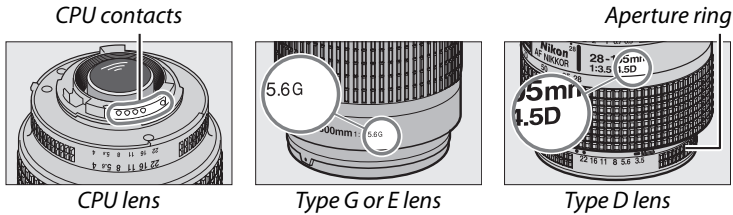
- 1 Spot metering meters selected focus point ( 90).
 - 2 Observe due caution when tilting or shifting PC-E NIKKOR 24mm f/3.5D ED lenses, as they may contact the camera body and cause damage or injury.
 - 3 Shifting and/or tilting the lens interferes with exposure.
 - 4 Can not be used with shifting or tilting.
 - 5 Optimal exposure will only be achieved if the lens is at maximum aperture and the lens is not shifted or tilted.
 - 6 With maximum effective aperture of f/5.6 or faster.
 - 7 When AF 80–200mm f/2.8, AF 35–70mm f/2.8, AF 28–85mm f/3.5–4.5 (New), or AF 28–85mm f/3.5–4.5 lenses are zoomed all the way in at the minimum focus distance, the in-focus indicator () may be displayed when the image on the matte screen in the viewfinder is not in focus. Before shooting, confirm that the image in the viewfinder screen is in focus.
 - 8 With maximum aperture of f/5.6 or faster.
- Noise in the form of lines may appear during autofocus when movies are recorded at high ISO sensitivities. Use manual focus or focus lock.

IX NIKKOR Lenses

IX NIKKOR lenses can not be used.

Identifying CPU and Type G, E, and D Lenses

CPU lenses can be identified by the presence of CPU contacts, type G, E, and D lenses by a letter on the lens barrel. Type G and E lenses are not equipped with a lens aperture ring.



When using a CPU lens equipped with an aperture ring, lock the aperture ring at the minimum aperture (highest f-number).

Matrix Metering

For matrix metering, the camera uses a 2016-pixel RGB sensor to set exposure according to tone distribution, color, composition, and, with type G, E, or D lenses, distance information (3D color matrix metering II; with other CPU lenses, the camera uses color matrix metering II; which does not include 3D distance information).

Compatible Non-CPU Lenses

Non-CPU lenses may only be used when the camera is in mode **M**. Selecting another mode disables the shutter release. Aperture must be adjusted manually via the lens aperture ring and the camera metering system, i-TTL flash control, and other features requiring a CPU lens can not be used. Some non-CPU lenses can not be used; see “Incompatible Accessories and Non-CPU Lenses,” below.

Lens/accessory	Camera setting	Focus			Mode
	AF	MF (with electronic rangefinder)	MF	M	Other modes
AI-, AI-modified NIKKOR or Nikon Series E lenses	—	✓ ¹	✓	✓ ²	—
Medical NIKKOR 120mm f/4	—	✓	✓	✓ ^{2,3}	—
Reflex NIKKOR	—	—	✓	✓ ²	—
PC NIKKOR	—	✓ ⁴	✓	✓ ²	—
AI-type Teleconverter	—	✓ ⁵	✓	✓ ²	—
PB-6 Bellows Focusing Attachment ⁶	—	✓ ¹	✓	✓ ²	—
Auto extension rings (PK-series 11A, 12, or 13; PN-11)	—	✓ ¹	✓	✓ ²	—

1 With maximum aperture of f/5.6 or faster.

2 Exposure indicator can not be used.

3 Can be used at shutter speeds slower than flash sync speed by one step or more.

4 Can not be used with shifting or tilting.

5 With maximum effective aperture of f/5.6 or faster.

6 Attach in vertical orientation (can be used in horizontal orientation once attached).

✓ Incompatible Accessories and Non-CPU Lenses

The following accessories and non-CPU lenses can NOT be used with the D5300:

- TC-16AS AF teleconverter
- Non-AI lenses
- Lenses that require the AU-1 focusing unit (400mm f/4.5, 600mm f/5.6, 800mm f/8, 1200mm f/11)
- Fisheye (6mm f/5.6, 7.5mm f/5.6, 8mm f/8, OP 10mm f/5.6)
- 2.1cm f/4
- Extension Ring K2
- 180–600mm f/8 ED (serial numbers 174041–174180)
- 360–1200mm f/11 ED (serial numbers 174031–174127)
- 200–600mm f/9.5 (serial numbers 280001–300490)
- AF lenses for the F3AF (AF 80mm f/2.8, AF 200mm f/3.5 ED, AF Teleconverter TC-16)
- PC 28mm f/4 (serial number 180900 or earlier)
- PC 35mm f/2.8 (serial numbers 851001–906200)
- PC 35mm f/3.5 (old type)
- Reflex 1000mm f/6.3 (old type)
- Reflex 1000mm f/11 (serial numbers 142361–143000)
- Reflex 2000mm f/11 (serial numbers 200111–200310)

AF-Assist Illumination

The AF-assist illuminator has a range of about 0.5–3.0 m (1 ft 8 in.–9 ft 10 in.); when using the illuminator, use a lens with a focal length of 18–200 mm and remove the lens hood. AF-assist illumination is not available with the following lenses:

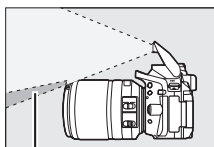
- AF-S NIKKOR 14–24mm f/2.8G ED
- AF-S NIKKOR 28–300mm f/3.5–5.6G ED VR
- AF-S DX NIKKOR 55–300mm f/4.5–5.6G ED VR
- AF-S VR Zoom-Nikkor 70–200mm f/2.8G IF-ED
- AF-S NIKKOR 70–200mm f/2.8G ED VR II
- AF-S Zoom-Nikkor 80–200mm f/2.8D IF-ED
- AF-S NIKKOR 80–400mm f/4.5–5.6G ED VR
- AF-S VR Nikkor 200mm f/2G IF-ED
- AF-S NIKKOR 200mm f/2G ED VR II
- AF-S VR Zoom-Nikkor 200–400mm f/4G IF-ED
- AF-S NIKKOR 200–400mm f/4G ED VR II

At ranges under 1 m (3 ft 3 in.), the following lenses may block the AF-assist illuminator and interfere with autofocus when lighting is poor:

- AF-S DX NIKKOR 10–24mm f/3.5–4.5G ED
- AF-S NIKKOR 16–35mm f/4G ED VR
- AF-S Zoom-Nikkor 17–35mm f/2.8D IF-ED
- AF-S DX Zoom-Nikkor 17–55mm f/2.8G IF-ED
- AF-S NIKKOR 18–35mm f/3.5–4.5G ED
- AF-S DX NIKKOR 18–105mm f/3.5–5.6G ED VR
- AF-S DX VR Zoom-Nikkor 18–200mm f/3.5–5.6G IF-ED
- AF-S DX NIKKOR 18–200mm f/3.5–5.6G ED VR II
- AF-S DX NIKKOR 18–300mm f/3.5–5.6G ED VR
- AF-S NIKKOR 24–70mm f/2.8G ED
- AF-S VR Zoom-Nikkor 24–120mm f/3.5–5.6G IF-ED
- AF-S NIKKOR 24–120mm f/4G ED VR
- AF-S NIKKOR 28mm f/1.8G
- AF-S Zoom-Nikkor 28–70mm f/2.8D IF-ED
- AF-S NIKKOR 35mm f/1.4G
- AF-S NIKKOR 70–200mm f/4G ED
- AF-S NIKKOR 70–200mm f/4G ED VR
- AF-S NIKKOR 85mm f/1.4G
- AF-S VR Micro-Nikkor 105mm f/2.8G IF-ED

✓ The Built-in Flash

The built-in flash can be used with lenses with focal lengths of 18–300 mm, although in some cases the flash may be unable to entirely light the subject at some ranges or focal lengths due to shadows cast by the lens (see the illustration below), while lenses that block the subject's view of the red-eye reduction lamp may interfere with red-eye reduction. Remove lens hoods to prevent shadows.



Shadow



Vignetting

The flash has a minimum range of 0.6 m and can not be used in the macro range of macro zoom lenses. The flash may be unable to light the entire subject with the following lenses at ranges less than those given below:

Lens	Zoom position	Minimum distance without vignetting
AF-S DX NIKKOR 10–24mm f/3.5–4.5G ED	24 mm	1.5 m/ 4 ft 11 in.
AF-S DX Zoom-Nikkor 12–24mm f/4G IF-ED	24 mm	1.0 m/ 3 ft 3 in.
AF-S NIKKOR 16–35mm f/4G ED VR	35 mm	1.0 m/ 3 ft 3 in.
AF-S DX NIKKOR 16–85mm f/3.5–5.6G ED VR	24–85 mm	No vignetting
AF-S Zoom-Nikkor 17–35mm f/2.8D IF-ED	28 mm	1.0 m/ 3 ft 3 in.
	35 mm	No vignetting
AF-S DX Zoom-Nikkor 17–55mm f/2.8G IF-ED	28 mm	1.5 m/ 4 ft 11 in.
	35 mm	1.0 m/ 3 ft 3 in.
	45–55 mm	No vignetting
AF-S NIKKOR 18–35mm f/3.5–4.5G ED	24 mm	1.5 m/ 4 ft 11 in.
	28 mm	1.0 m/ 3 ft 3 in.
	35 mm	No vignetting
AF Zoom-Nikkor 18–35mm f/3.5–4.5D IF-ED	24 mm	1.0 m/ 3 ft 3 in.
	28–35 mm	No vignetting
AF-P DX NIKKOR 18–55mm f/3.5–5.6G VR, AF-P DX NIKKOR 18–55mm f/3.5–5.6G	18 mm	1.0 m/ 3 ft 4 in.
	24–55 mm	No vignetting
AF-S DX Zoom-Nikkor 18–70mm f/3.5–4.5G IF-ED	18 mm	1.0 m/ 3 ft 3 in.
	24–70 mm	No vignetting
AF-S DX NIKKOR 18–105mm f/3.5–5.6G ED VR	18 mm	2.5 m/ 8 ft 2 in.
	24 mm	1.0 m/ 3 ft 3 in.
AF-S DX Zoom-Nikkor 18–135mm f/3.5–5.6G IF-ED	18 mm	2.0 m/ 6 ft 7 in.
	24–135 mm	No vignetting
AF-S DX NIKKOR 18–140mm f/3.5–5.6G ED VR	24 mm	1.0 m/ 3 ft 3 in.
	35–140 mm	No vignetting
AF-S DX VR Zoom-Nikkor 18–200mm f/3.5–5.6G IF-ED, AF-S DX NIKKOR 18–200mm f/3.5–5.6G ED VR II	24 mm	1.0 m/ 3 ft 3 in.
AF-S DX NIKKOR 18–300mm f/3.5–5.6G ED VR	35–300 mm	No vignetting
		1.0 m/ 3 ft 3 in.

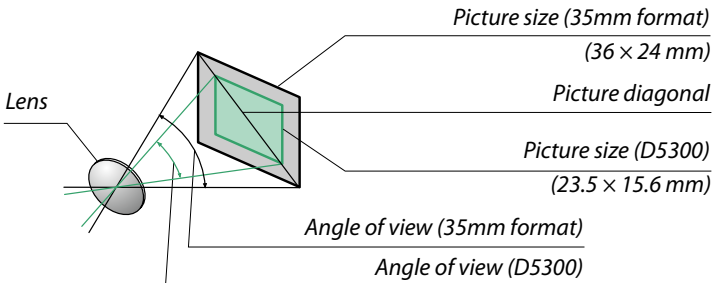
Lens	Zoom position	Minimum distance without vignetting
AF Zoom-Nikkor 20–35mm f/2.8D IF	24 mm	2.5 m/ 8 ft 2 in.
	28 mm	1.0 m/ 3 ft 3 in.
	35 mm	No vignetting
AF-S NIKKOR 24mm f/1.4G ED	24 mm	1.0 m/ 3 ft 3 in.
AF-S NIKKOR 24–70mm f/2.8G ED	35 mm	1.5 m/ 4 ft 11 in.
	50–70 mm	No vignetting
AF-S VR Zoom-Nikkor 24–120mm f/3.5–5.6G IF-ED	24 mm	1.0 m/ 3 ft 3 in.
	28–120 mm	No vignetting
AF-S NIKKOR 24–120mm f/4G ED VR	24 mm	1.5 m/ 4 ft 11 in.
AF-S Zoom-Nikkor 28–70mm f/2.8D IF-ED	35 mm	1.5 m/ 4 ft 11 in.
	50–70 mm	No vignetting
AF-S NIKKOR 28–300mm f/3.5–5.6G ED VR	28 mm	1.5 m/ 4 ft 11 in.
	35 mm	1.0 m/ 3 ft 3 in.
AF-S VR Zoom-Nikkor 200–400mm f/4G IF-ED	250 mm	2.5 m/ 8 ft 2 in.
	350 mm	2.0 m/ 6 ft 7 in.
AF-S NIKKOR 200–400mm f/4G ED VR II	200 mm	5.0 m/16 ft 5 in.
	250 mm	3.0 m/ 9 ft 10 in.
	300–400 mm	No vignetting
PC-E NIKKOR 24mm f/3.5D ED *	24 mm	3.0 m/ 9 ft 10 in.

* When not shifted or tilted.

When used with the AF-S NIKKOR 14–24mm f/2.8G ED, the flash will be unable to light the entire subject at all ranges.

Calculating Angle of View

The size of the area exposed by a 35 mm camera is 36×24 mm. The size of the area exposed by the D5300, in contrast, is 23.5×15.6 mm, meaning that the angle of view of a 35 mm camera is approximately 1.5 times that of the D5300. The approximate focal length of lenses for the D5300 in 35 mm format can be calculated by multiplying the focal length of the lens by about 1.5.




Optional Flash Units (Speedlights)

The camera supports the Nikon Creative Lighting System (CLS) and can be used with CLS-compatible flash units. The built-in flash will not fire when an optional flash unit is attached.

Flash Units Compatible with the Creative Lighting System (CLS)

The camera can be used with the following CLS-compatible flash units:

Feature		Flash unit							
		SB-910 ¹	SB-900 ¹	SB-800	SB-700 ¹	SB-600	SB-400 ²	SB-300 ²	SB-R200 ³
Guide No. ⁴	ISO 100	34/111	34/111	38/125	28/92	30/98	21/69	18/59	10/33
	ISO 200	48/157	48/157	53/174	39/128	42/138	30/98	25/82	14/46

- 1 If a color filter is attached to the SB-910, SB-900, or SB-700 when **AUTO** or  (flash) is selected for white balance, the camera will automatically detect the filter and adjust white balance appropriately.
 - 2 Wireless flash control is not available.
 - 3 Controlled remotely using optional SB-910, SB-900, SB-800, or SB-700 flash unit or SU-800 wireless Speedlight commander.
 - 4 m/ft, 20 °C (68 °F), SB-910, SB-900, SB-800, SB-700, and SB-600 at 35 mm zoom head position; SB-910, SB-900, and SB-700 with standard illumination.
- **The SU-800 wireless speedlight commander:** When mounted on a CLS-compatible camera, the SU-800 can be used as a commander for remote SB-910, SB-900, SB-800, SB-700, SB-600, or SB-R200 flash units in up to three groups. The SU-800 itself is not equipped with a flash.

The Nikon Creative Lighting System (CLS)

Nikon's advanced Creative Lighting System (CLS) offers improved communication between the camera and compatible flash units for improved flash photography. Refer to the documentation provided with the flash unit for details.

Guide Number

To calculate the range of the flash at full power, divide the Guide Number by the aperture. For example, at ISO 100 the SB-800 has a Guide Number of 38 m or 125 ft (35 mm zoom head position); its range at an aperture of f/5.6 is $38 \div 5.6$ or about 6.8 meters (or in feet, $125 \div 5.6 =$ approximately 23 ft 7 in.). For each twofold increase in ISO sensitivity, multiply the Guide Number by the square root of two (approximately 1.4).

The following features are available with CLS-compatible flash units:

		CLS-compatible flash units									
		SB-910 SB-900	SB-800	SB-700	SB-600	SU-800		SB-R200	SB-400	SB-300	
						Commander	Close-up photography				
Single flash	i-TTL	i-TTL balanced fill-flash for digital SLR ¹	✓	✓	✓	✓	—	—	—	✓	✓
		Standard i-TTL flash for digital SLR	✓ ²	✓ ²	✓	✓ ²	—	—	—	✓	✓
	AA	Auto aperture	✓ ³	✓ ³	—	—	—	—	—	—	—
	A	Non-TTL auto	✓ ³	✓ ³	—	—	—	—	—	—	—
	GN	Distance-priority manual	✓	✓	✓	—	—	—	—	—	—
	M	Manual	✓	✓	✓	✓	—	—	—	✓ ⁴	✓ ⁴
	RPT	Repeating flash	✓	✓	—	—	—	—	—	—	—
Advanced Wireless Lighting	Master	Remote flash control	✓	✓	✓	—	✓	✓	—	—	—
		i-TTL	i-TTL	✓	✓	✓	—	—	—	—	—
		[A:B]	Quick wireless flash control	—	—	✓	—	—	✓	—	—
		AA	Auto aperture	✓ ⁵	✓ ⁵	—	—	—	—	—	—
		A	Non-TTL auto	✓	✓	—	—	—	—	—	—
		M	Manual	✓	✓	✓	—	—	—	—	—
		RPT	Repeating flash	✓	✓	—	—	—	—	—	—
	Remote	i-TTL	i-TTL	✓	✓	✓	✓	—	—	✓	—
		[A:B]	Quick wireless flash control	✓	✓	✓	✓	—	—	✓	—
		AA	Auto aperture	✓ ⁵	✓ ⁵	—	—	—	—	—	—
		A	Non-TTL auto	✓	✓	—	—	—	—	—	—
	M	Manual	✓	✓	✓	✓	—	—	✓	—	
	RPT	Repeating flash	✓	✓	✓	✓	—	—	—	—	
Flash Color Information		✓	✓	✓	✓	—	—	—	✓	✓	
Communication		✓	✓	✓	✓	—	—	—	✓	✓	
AF-assist for multi-area AF		✓	✓	✓	✓	✓	—	—	—	—	
Red-eye reduction		✓	✓	✓	✓	—	—	—	✓	—	
Camera flash mode selection		—	—	—	—	—	—	—	✓	✓	
Camera flash unit firmware update		✓	—	✓	—	—	—	—	—	✓	

1 Not available with spot metering.

2 Can also be selected with flash unit.


3 AA/A mode selection performed on flash unit using custom settings. A is selected when a non-CPU lens is used.

4 Can only be selected with camera (□ 192).

5 When a non-CPU lens is used, non-TTL auto (A) is used regardless of mode selected with flash unit.

■ ■ Other Flash Units

The following flash units can be used in non-TTL auto and manual modes. Use with the camera in exposure mode **S** or **M** and a shutter speed of $\frac{1}{200}$ s or slower selected.

Flash mode \ Flash unit	SB-80DX, SB-28DX, SB-28, SB-26, SB-25, SB-24	SB-50DX ¹	SB-30, SB-27 ² , SB-22S, SB-22, SB-20, SB-16B, SB-15	SB-23, SB-29 ³ , SB-21B ³ , SB-29S ³
A Non-TTL auto	✓	—	✓	—
M Manual	✓	✓	✓	✓
 Repeating flash	✓	—	—	—
REAR Rear-curtain sync ⁴	✓	✓	✓	✓

- 1 Select mode **P**, **S**, **A**, or **M**, lower built-in flash, and use optional flash unit only.
- 2 Flash mode is automatically set to TTL and shutter-release is disabled. Set flash unit to **A** (non-TTL auto flash).
- 3 Autofocus is available with AF-S VR Micro-Nikkor 105mm f/2.8G IF-ED and AF-S Micro NIKKOR 60mm f/2.8G ED lenses only.
- 4 Available when camera is used to select flash mode.

The AS-15 Sync Terminal Adapter





When the AS-15 sync terminal adapter (available separately) is mounted on the camera accessory shoe, flash accessories can be connected via a sync cable.

Use Only Nikon Flash Accessories

Use only Nikon flash units. Negative voltages or voltages over 250 V applied to the accessory shoe could not only prevent normal operation, but damage the sync circuitry of the camera or flash. Before using a Nikon flash unit not listed in this section, contact a Nikon-authorized service representative for more information.

✓ Notes on Optional Flash Units


Refer to the Speedlight manual for detailed instructions. If the flash unit supports CLS, refer to the section on CLS-compatible digital SLR cameras. The D5300 is not included in the “digital SLR” category in the SB-80DX, SB-28DX, and SB-50DX manuals.

If an optional flash unit is attached in shooting modes other than , , , and  the flash will fire with every shot, even in modes in which the built-in flash can not be used.

i-TTL flash control can be used at ISO sensitivities between 100 and 12800. At values over 12800, the desired results may not be achieved at some ranges or aperture settings. If the flash-ready indicator flashes for about three seconds after a photograph is taken, the flash has fired at full power and the photograph may be underexposed (CLS-compatible flash units only; for information on the exposure and flash charge indicators on other units, see the manual provided with the flash).

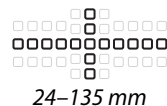
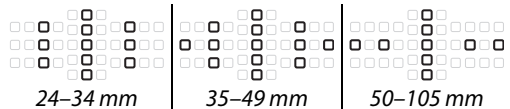
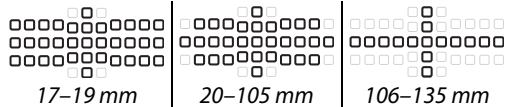
When an SC-series 17, 28, or 29 sync cable is used for off-camera flash photography, correct exposure may not be achieved in i-TTL mode. We recommend that you choose spot metering to select standard i-TTL flash control. Take a test shot and view the results in the monitor.

In i-TTL, use the flash panel or bounce adapter provided with the flash unit. Do not use other panels such as diffusion panels, as this may produce incorrect exposure.

If the controls on the optional SB-910, SB-900, SB-800, SB-700 or SB-600 flash unit or SU-800 wireless Speedlight commander are used to set flash compensation,  will appear in the information display.

The SB-910, SB-900, SB-800, SB-700, SB-600, and SB-400 provide red-eye reduction, while the SB-910, SB-900, SB-800, SB-700, SB-600, and SU-800 provide AF-assist illumination with the following restrictions:

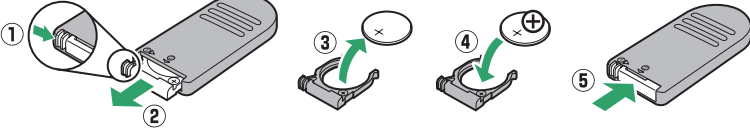
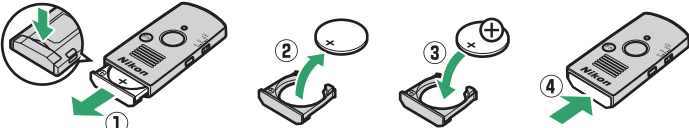
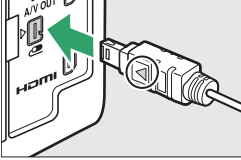
- **SB-910 and SB-900:** AF-assist illumination is available with 17–135 mm AF lenses, however, autofocus is available only with the focus points shown at right.
- **SB-800, SB-600, and SU-800:** AF-assist illumination is available with 24–105 mm AF lenses, however, autofocus is available only with the focus points shown at right.
- **SB-700:** AF-assist illumination is available with 24–135 mm AF lenses, however, autofocus is available only with the focus points shown at right.



Other Accessories

At the time of writing, the following accessories were available for the D5300.

Power sources	<ul style="list-style-type: none">• Rechargeable Li-ion Battery EN-EL14a (□ 11): Additional EN-EL14a batteries are available from local retailers and Nikon-authorized service representatives. EN-EL14 batteries can also be used.• Battery Charger MH-24 (□ 11): Recharge EN-EL14a and EN-EL14 batteries.• Power Connector EP-5A, AC Adapter EH-5b: These accessories can be used to power the camera for extended periods (EH-5a and EH-5 AC adapters can also be used). A power connector EP-5A is required to connect the camera to the EH-5b, EH-5a, or EH-5; see page 239 for details.
Filters	<ul style="list-style-type: none">• Filters intended for special-effects photography may interfere with autofocus or the electronic rangefinder.• The D5300 can not be used with linear polarizing filters. Use C-PL or C-PL II circular polarizing filters instead.• NC filters are recommended for protecting the lens.• To prevent ghosting, use of a filter is not recommended when the subject is framed against a bright light, or when a bright light source is in the frame.• Center-weighted metering is recommended with filters with exposure factors (filter factors) over $1 \times$ (Y44, Y48, Y52, O56, R60, X0, X1, C-PL, ND2S, ND4, ND4S, ND8, ND8S, ND400, A2, A12, B2, B8, B12). See the filter manual for details.
Viewfinder eyepiece accessories	<ul style="list-style-type: none">• DK-20C Eyepiece Correction Lenses: Lenses are available with diopters of -5, -4, -3, -2, 0, $+0.5$, $+1$, $+2$, and $+3 \text{ m}^{-1}$ when the camera diopter adjustment control is in the neutral position (-1 m^{-1}). Use eyepiece correction lenses only if the desired focus can not be achieved with the built in diopter adjustment control (-1.7 to $+1.0 \text{ m}^{-1}$). Test eyepiece correction lenses before purchase to ensure that the desired focus can be achieved. The rubber eyecup can not be used with eyepiece correction lenses.• Magnifier DG-2: The DG-2 magnifies the scene displayed in the center of the viewfinder for greater precision during focusing. Eyepiece adapter required (available separately).• Eyepiece Adapter DK-22: The DK-22 is used when attaching the DG-2 magnifier. The monitor can not be rotated with the adapter in place.• Right-Angle Viewing Attachment DR-6: The DR-6 attaches at a right angle to the viewfinder eyepiece, allowing the image in the viewfinder to be viewed at right angles to the lens (for example, from directly above when the camera is horizontal). The monitor can not be rotated with the attachment in place.
Software	<ul style="list-style-type: none">• Capture NX 2: A complete photo editing package offering such features as white balance adjustment and color control points.• Camera Control Pro 2: Control the camera remotely from a computer to record movies and photographs and save photographs directly to the computer hard disk. <p>Note: Use the latest versions of Nikon software. Most Nikon software offers an auto update feature (Nikon Message Center 2) when the computer is connected to the Internet. See the websites listed on page xiv for the latest information on supported operating systems.</p>

Body cap	Body Cap BF-1B/Body Cap BF-1A: The body cap keeps the mirror, viewfinder screen, and image sensor free of dust when a lens is not in place.
Remote controls/ wireless remote controller	<ul style="list-style-type: none"> • Wireless Remote Control ML-L3 (□ 70): The ML-L3 uses a 3 V CR2025 battery.  <p>Pressing the battery-chamber latch to the right (①), insert a fingernail into the gap and open the battery chamber (②). Ensure that the battery is inserted in the correct orientation (④).</p> • Wireless Remote Controller WR-R10*/WR-T10: When a WR-R10 wireless remote controller is attached, the camera can be controlled wirelessly using a WR-T10 wireless remote controller (□ 71, 203). The WR-T10 uses a 3 V CR2032 battery.  <p>Insert a fingernail into the gap behind the battery-chamber latch and open the battery chamber (①). Ensure that the battery is inserted in the correct orientation (③).</p> • Wireless Remote Controller WR-1 (□ 71, 203): WR-1 units are used in groups of two or more, with one functioning as a transmitter and the remaining units acting as receivers. The receivers are attached to the accessory terminals of one or more cameras, allowing the transmitter to be used to release the camera shutters.
Microphones	Stereo Microphone ME-1 (□ 129)*
Accessory terminal accessories	<p>The D5300 is equipped with an accessory terminal for WR-1 and WR-R10 wireless remote controllers (□ 71), MC-DC2 remote cords (□ 88), and GP-1/GP-1A GPS units (□ 81), which connect with the ◀ mark on the connector aligned with the ▶ next to the accessory terminal (close the connector cover when the terminal is not in use).</p> 
USB and A/V connector accessories	<ul style="list-style-type: none"> • UC-E17 and UC-E6 USB cables (□ 153, 156): The supplied UC-E17 cable is not available for separate purchase; purchase UC-E6 cables instead. • EG-CP16 audio/video cables

* A wireless remote controller can not be attached at the same time as an ME-1 stereo microphone. Attempting to forcibly attach accessories can damage the camera or accessory.



Optional Accessories

Availability may vary with country or region. See our website or brochures for the latest information.

Approved Memory Cards

The camera supports SD, SDHC, and SDXC memory cards, including SDHC and SDXC cards compliant with UHS-I. Cards rated SD Speed Class 6 or better are recommended for movie recording; using slower cards may result in recording being interrupted. When choosing cards for use in card readers, be sure they are compatible with the device. Contact the manufacturer for information on features, operation, and limitations on use.

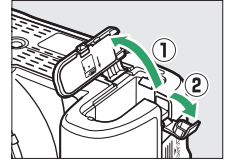


Attaching a Power Connector and AC Adapter

Turn the camera off before attaching an optional power connector and AC adapter.

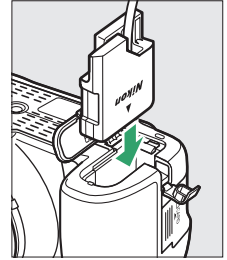
1 Ready the camera.

Open the battery-chamber (①) and power connector (②) covers.



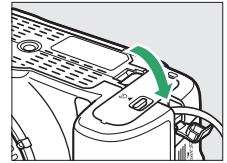
2 Insert the EP-5A power connector.

Be sure to insert the connector in the orientation shown, using the connector to keep the orange battery latch pressed to one side. Be sure the connector is fully inserted.




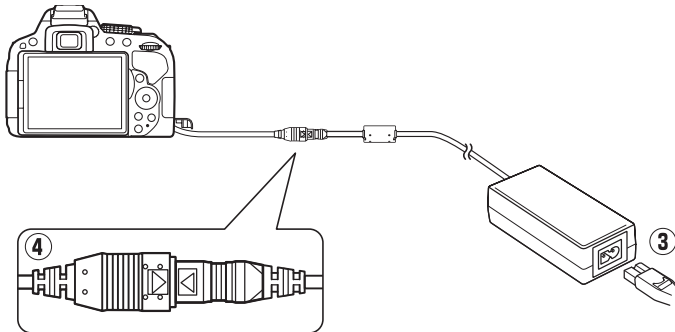
3 Close the battery-chamber cover.

Position the power connector cable so that it passes through the power connector slot and close the battery-chamber cover.



4 Connect the AC adapter.

Connect the AC adapter power cable to the AC socket (③) and the EP-5A power cable to the DC socket (④). A  icon is displayed in the monitor when the camera is powered by the AC adapter and power connector.



Caring for the Camera

Storage

When the camera will not be used for an extended period, remove the battery and store it in a cool, dry area with the terminal cover in place. To prevent mold or mildew, store the camera in a dry, well-ventilated area. Do not store your camera with naphtha or camphor moth balls or in locations that:

- are poorly ventilated or subject to humidities of over 60%
- are next to equipment that produces strong electromagnetic fields, such as televisions or radios
- are exposed to temperatures above 50 °C (122 °F) or below –10 °C (14 °F)

Cleaning

Camera body	Use a blower to remove dust and lint, then wipe gently with a soft, dry cloth. After using the camera at the beach or seaside, wipe off sand or salt with a cloth lightly dampened in distilled water and dry thoroughly. Important: <i>Dust or other foreign matter inside the camera may cause damage not covered under warranty.</i>
Lens, mirror, and viewfinder	These glass elements are easily damaged. Remove dust and lint with a blower. If using an aerosol blower, keep the can vertical to prevent the discharge of liquid. To remove fingerprints and other stains, apply a small amount of lens cleaner to a soft cloth and clean with care.
Monitor	Remove dust and lint with a blower. When removing fingerprints and other stains, wipe the surface lightly with a soft cloth or chamois leather. Do not apply pressure, as this could result in damage or malfunction.

Do not use alcohol, thinner, or other volatile chemicals.

Servicing the Camera and Accessories

The camera is a precision device and requires regular servicing. Nikon recommends that the camera be inspected by the original retailer or Nikon-authorized service representative once every one to two years, and that it be serviced once every three to five years (note that fees apply to these services). Frequent inspection and servicing are particularly recommended if the camera is used professionally. Any accessories regularly used with the camera, such as lenses or optional flash units, should be included when the camera is inspected or serviced.

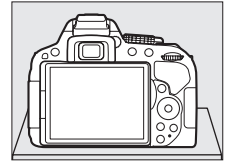
Image Sensor Cleaning

If you suspect that dirt or dust on the image sensor is appearing in photographs, you can clean the sensor using the **Clean image sensor** option in the setup menu. The sensor can be cleaned at any time using the **Clean now** option, or cleaning can be performed automatically when the camera is turned on or off.

■ ■ “Clean Now”

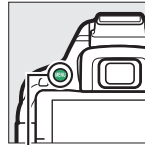
1 Place the camera base down.

Image sensor cleaning is most effective when the camera is placed base down as shown at right.

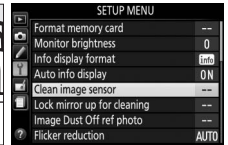


2 Select Clean image sensor in the setup menu.

Press the **MENU** button to display the menus. Highlight **Clean image sensor** in the setup menu (📖 195) and press **▶**.

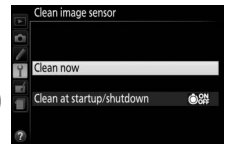


MENU button

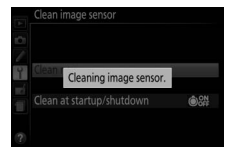


3 Select Clean now.

Highlight **Clean now** and press **OK**.

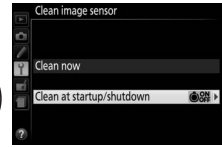


The camera will check the image sensor and then begin cleaning. **b 5 3** flashes in the viewfinder and other operations can not be performed. Do not remove or disconnect the power source until cleaning is complete and the message shown at right is no longer displayed.

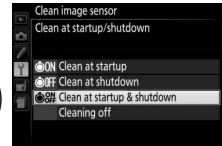


■ ■ “Clean at Startup/Shutdown”

- 1 Select Clean at startup/shutdown.**
Select **Clean image sensor**, then highlight **Clean at startup/shutdown** and press ►.



- 2 Select an option.**
Highlight an option and press Ⓞ. Choose from **Clean at startup**, **Clean at shutdown**, **Clean at startup & shutdown**, and **Cleaning off**.



✓ **Image Sensor Cleaning**

Using camera controls during startup interrupts image sensor cleaning.

Cleaning is performed by vibrating the image sensor. If dust can not be fully removed using the options in the **Clean image sensor** menu, clean the image sensor manually (📖 243) or consult a Nikon-authorized service representative.

If image sensor cleaning is performed several times in succession, image sensor cleaning may be temporarily disabled to protect the camera's internal circuitry. Cleaning can be performed again after a short wait.

Manual Cleaning

If foreign matter can not be removed from the image sensor using the **Clean image sensor** option in the setup menu (☐ 241), the sensor can be cleaned manually as described below. Note, however, that the sensor is extremely delicate and easily damaged. Nikon recommends that the sensor be cleaned only by Nikon-authorized service personnel.


1 Charge the battery.

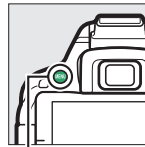
A reliable power source is required when inspecting or cleaning the image sensor. Be sure the battery is fully charged before proceeding.

2 Remove the lens.

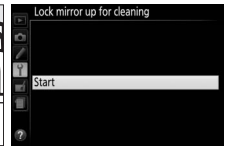
Turn the camera off and remove the lens.

3 Select Lock mirror up for cleaning.

Turn the camera on and press the MENU button to display the menus. Highlight **Lock mirror up for cleaning** in the setup menu and press ► (note that this option is not available at battery levels of  or below).

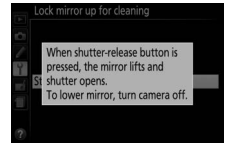


MENU button



4 Press .

The message shown at right will be displayed in the monitor.



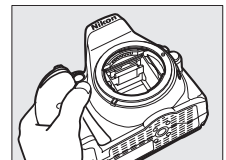
5 Raise the mirror.

Press the shutter-release button all the way down. The mirror will be raised and the shutter curtain will open, revealing the image sensor.



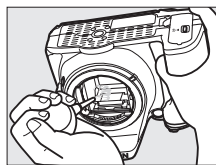
6 Examine the image sensor.

Holding the camera so that light falls on the image sensor, examine the interior of the camera for dust or lint. If no foreign objects are present, proceed to Step 8.



7 Clean the sensor.

Remove any dust and lint from the sensor with a blower. Do not use a blower-brush, as the bristles could damage the sensor. Dirt that can not be removed with a blower can only be removed by Nikon-authorized service personnel. Under no circumstances should you touch or wipe the sensor.



8 Turn the camera off.

The mirror will return to the down position and the shutter curtain will close. Replace the lens or body cap.

Use a Reliable Power Source

The shutter curtain is delicate and easily damaged. If the camera powers off while the mirror is raised, the curtain will close automatically. To prevent damage to the curtain, observe the following precautions:

- Do not turn the camera off or remove or disconnect the power source while the mirror is raised.
- If the battery runs low while the mirror is raised, a beep will sound and the self-timer lamp will flash to warn that the shutter curtain will close and the mirror will be lowered after about two minutes. End cleaning or inspection immediately.

Foreign Matter on the Image Sensor

Foreign matter entering the camera when lenses or body caps are removed or exchanged (or in rare circumstances lubricant or fine particles from the camera itself) may adhere to the image sensor, where it may appear in photographs taken under certain conditions. To protect the camera when no lens is in place, be sure to replace the body cap provided with the camera, being careful to first remove all dust and other foreign matter that may be adhering to the camera mount, lens mount, and body cap. Avoid attaching the body cap or exchanging lenses in dusty environments.

Should foreign matter find its way onto the image sensor, use the image sensor cleaning option as described on page 241. If the problem persists, clean the sensor manually (☐ 243) or have the sensor cleaned by authorized Nikon service personnel. Photographs affected by the presence of foreign matter on the sensor can be retouched using the clean image options available in some imaging applications.

Caring for the Camera and Battery: Cautions

Caring for the Camera

Do not drop: The product may malfunction if subjected to strong shocks or vibration.

Keep dry: This product is not waterproof, and may malfunction if immersed in water or exposed to high levels of humidity. Rusting of the internal mechanism can cause irreparable damage.

Avoid sudden changes in temperature: Sudden changes in temperature, such as those that occur when entering or leaving a heated building on a cold day, can cause condensation inside the device. To prevent condensation, place the device in a carrying case or plastic bag before exposing it to sudden changes in temperature.

Keep away from strong magnetic fields: Do not use or store this device in the vicinity of equipment that generates strong electromagnetic radiation or magnetic fields. Strong static charges or the magnetic fields produced by equipment such as radio transmitters could interfere with the monitor, damage data stored on the memory card, or affect the product's internal circuitry.

Do not leave the lens pointed at the sun: Do not leave the lens pointed at the sun or other strong light source for an extended period. Intense light may cause the image sensor to deteriorate or produce a white blur effect in photographs.

Turn the product off before removing or disconnecting the power source: Do not unplug the product or remove the battery while the product is on or while images are being recorded or deleted. Forcibly cutting power in these circumstances could result in loss of data or in damage to product memory or internal circuitry. To prevent an accidental interruption of power, avoid carrying the product from one location to another while the AC adapter is connected.

Cleaning: When cleaning the camera body, use a blower to gently remove dust and lint, then wipe gently with a soft, dry cloth. After using the camera at the beach or seaside, wipe off any sand or salt using a cloth lightly dampened in pure water and then dry the camera thoroughly.

The lens and mirror are easily damaged. Dust and lint should be gently removed with a blower. When using an aerosol blower, keep the can vertical to prevent discharge of liquid. To remove fingerprints and other stains from the lens, apply a small amount of lens cleaner to a soft cloth and wipe the lens carefully.

See “Image Sensor Cleaning” (☞ 241, 243) for information on cleaning the image sensor.

Do not touch the shutter curtain: The shutter curtain is extremely thin and easily damaged. Under no circumstances should you exert pressure on the curtain, poke it with cleaning tools, or subject it to powerful air currents from a blower. These actions could scratch, deform, or tear the curtain.

Storage: To prevent mold or mildew, store the camera in a dry, well-ventilated area. If you are using an AC adapter, unplug the adapter to prevent fire. If the product will not be used for an extended period, remove the battery to prevent leakage and store the camera in a plastic bag containing a desiccant. Do not, however, store the camera case in a plastic bag, as this may cause the material to deteriorate. Note that desiccant gradually loses its capacity to absorb moisture and should be replaced at regular intervals.

To prevent mold or mildew, take the camera out of storage at least once a month. Turn the camera on and release the shutter a few times before putting it away.

Store the battery in a cool, dry place. Replace the terminal cover before putting the battery away.

Notes on the monitor: The monitor is constructed with extremely high precision; at least 99.99% of pixels are effective, with no more than 0.01% being missing or defective. Hence while these displays may contain pixels that are always lit (white, red, blue, or green) or always off (black), this is not a malfunction and has no effect on images recorded with the device.

Images in the monitor may be difficult to see in a bright light.

Do not apply pressure to the monitor, as this could cause damage or malfunction. Dust or lint on the monitor can be removed with a blower. Stains can be removed by wiping lightly with a soft cloth or chamois leather. Should the monitor break, care should be taken to avoid injury from broken glass and to prevent liquid crystal from the monitor touching the skin or entering the eyes and mouth.

Moiré: Moiré is an interference pattern created by the interaction of an image containing a regular, repeating grid, such as the pattern of weave in cloth or windows in a building, with the camera image sensor grid. If you notice moiré in your photographs, try changing the distance to the subject, zooming in and out, or changing the angle between the subject and the camera.

Caring for the Battery








Batteries may leak or explode if improperly handled. Observe the following precautions when handling batteries:




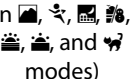
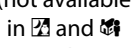
- Use only batteries approved for use in this equipment.
- Do not expose the battery to flame or excessive heat.
- Keep the battery terminals clean.
- Turn the product off before replacing the battery.
- Remove the battery from the camera or charger when not in use and replace the terminal cover. These devices draw minute amounts of charge even when off and could draw the battery down to the point that it will no longer function. If the battery will not be used for some time, insert it in the camera and run it flat before removing it and storing it in a location with an ambient temperature of 15 °C to 25 °C (59 °F to 77 °F; avoid hot or extremely cold locations). Repeat this process at least once every six months.
- Turning the camera on and off repeatedly when the battery is fully discharged will shorten battery life. Batteries that have been fully discharged must be charged before use.

- The internal temperature of the battery may rise while the battery is in use. Attempting to charge the battery while the internal temperature is elevated will impair battery performance, and the battery may not charge or charge only partially. Wait for the battery to cool before charging.
- Continuing to charge the battery after it is fully charged can impair battery performance.
- A marked drop in the time a fully charged battery retains its charge when used at room temperature indicates that it requires replacement. Purchase a new EN-EL14a battery.
- Charge the battery before use. When taking photographs on important occasions, ready a spare EN-EL14a battery and keep it fully charged. Depending on your location, it may be difficult to purchase replacement batteries on short notice. Note that on cold days, the capacity of batteries tends to decrease. Be sure the battery is fully charged before taking photographs outside in cold weather. Keep a spare battery in a warm place and exchange the two as necessary. Once warmed, a cold battery may recover some of its charge.
- Used batteries are a valuable resource; recycle in accord with local regulations.

Available Settings

The following table lists the settings that can be adjusted in each mode.

		P, S, A, M			
Image quality ²	✓	✓	✓	✓	
Image size ²	✓	✓	✓	✓	
White balance ²	—	✓	—	—	
Set Picture Control ²	—	✓	—	—	
Auto distortion control	✓	✓	✓	✓	
Color space	✓	✓	✓	✓	
Active D-Lighting ²	—	✓	—	—	
HDR (high dynamic range) ²	—	✓	—	—	
Shooting menu	Long exposure NR	✓	✓	✓ (not available in  mode)	
	High ISO NR	✓	✓	✓ (not available in  mode)	
	ISO sensitivity settings ³	—	✓	✓ (not available in  mode)	
	Release mode ²	✓ ⁴	✓	✓ ⁴ ✓ ⁴	
	Multiple exposure ²	—	✓	—	
	Interval timer shooting	✓	✓	✓	✓ (not available in  mode)
	Movie settings	✓	✓	✓	✓

		P, S, A, M		
a1: AF-C priority selection	✓	✓	✓	✓
a2: Number of focus points	✓	✓	✓	✓
a3: Built-in AF-assist illuminator	✓	✓	(not available in )	(not available in )
a4: Rangefinder	✓	✓	✓	✓
b1: EV steps for exposure cntrl	✓	✓	✓	✓
c1: Shutter-release button AE-L	✓	✓	✓	✓
c2: Auto off timers	✓	✓	✓	✓
c3: Self-timer	✓	✓	✓	✓
c4: Remote on duration (ML-L3)	✓	✓	✓	✓
d1: Beep	✓	✓	✓	✓
d2: Viewfinder grid display	✓	✓	✓	✓
d3: ISO display	✓	✓	✓	✓
d4: File number sequence	✓	✓	✓	✓
d5: Exposure delay mode	✓	✓	✓	✓
d6: Print date	✓	✓	✓	✓
e1: Flash cntrl for built-in flash	—	✓	—	—
e2: Auto bracketing set	—	✓	—	—
f1: Assign Fn button	✓	✓	✓	✓
f2: Assign AE-L/AF-L button	✓	✓	✓	✓
f3: Reverse dial rotation	✓	✓	✓	✓
f4: Slot empty release lock	✓	✓	✓	✓
f5: Reverse indicators	✓	✓	✓	✓

Custom Settings *

* Reset with **Reset custom settings** (☐ 183).

Troubleshooting

If the camera fails to function as expected, check the list of common problems below before consulting your retailer or Nikon representative.

Battery/Display

The camera is on but does not respond: Wait for recording to end. If the problem persists, turn the camera off. If the camera does not turn off, remove and reinsert the battery or, if you are using an AC adapter, disconnect and reconnect the AC adapter. Note that although any data currently being recorded will be lost, data that have already been recorded will not be affected by removing or disconnecting the power source.

Viewfinder is out of focus: Adjust viewfinder focus (□ 16). If this does not correct the problem, select single-servo autofocus (**AF-S**; □ 51), single-point AF (**[*]**; □ 53), and the center focus point, and then frame a high-contrast subject in the center focus point and press the shutter-release button halfway to focus the camera. With the camera in focus, use the diopter adjustment control to bring the subject into clear focus in the viewfinder. If necessary, viewfinder focus can be further adjusted using optional corrective lenses (□ 236).

Displays turn off without warning: Choose longer delays for Custom Setting c2 (**Auto off timers**; □ 186).

Information display does not appear in monitor: Shutter-release button is pressed halfway. If information display does not appear when you remove your finger from shutter-release button, confirm that **On** is selected for **Auto info display** (□ 199) and that battery is charged.

Viewfinder display is unresponsive and dim: The response times and brightness of this display vary with temperature.

Shooting (All Modes)

Camera takes time to turn on: Delete files or folders.

Shutter-release disabled:



- Memory card is locked, full, or not inserted (□ 12, 15).
- **Release locked** is selected for Custom Setting f4 (**Slot empty release lock**; □ 194) and no memory card is inserted (□ 12).
- Built-in flash is charging (□ 23).
- Camera is not in focus (□ 21).
- CPU lens with aperture ring attached but aperture not locked at highest f-number (□ 227).
- Non-CPU lens is attached but camera is not in mode **M** (□ 228).

Only one shot taken each time shutter-release button is pressed in continuous shooting mode: Continuous shooting is not available if built-in flash fires (□ 47, 62).


Final photo is larger than area shown in viewfinder: Viewfinder horizontal and vertical frame coverage is approximately 95%.

Photos are out of focus:

- AF-S, AF-P, or AF-I lens is not attached: use AF-S, AF-P, or AF-I lens or focus manually.
- Camera unable to focus using autofocus: use manual focus or focus lock (☐ 52, 55, 57).
- Camera is in manual focus mode: focus manually (☐ 57).

Focus does not lock when shutter-release button is pressed halfway: Use  (O-) button to lock focus when live view is off and **AF-C** is selected for focus mode or when photographing moving subjects in **AF-A** mode (☐ 55).

Can not select focus point:

-  (**Auto-area AF**; ☐ 53) is selected: choose another AF-area mode.
- Press shutter-release button halfway to start standby timer (☐ 23).

Can not select AF-area mode: Manual focus selected (☐ 51, 57).

AF-assist illuminator does not light:

- AF-assist illuminator does not light if **AF-C** is selected for autofocus mode (☐ 51) or if continuous-servo autofocus is selected when the camera is in **AF-A** mode. Choose **AF-S**. AF-assist is also not available when 3D-tracking is selected for AF-area mode; if single-point or dynamic-area AF is selected, select center focus point (☐ 53, 55).
- The camera is currently in live view or a movie is being recorded.
- **Off** is selected for Custom Setting a3 (**Built-in AF-assist illuminator**, ☐ 185).
- The AF-assist illuminator can not be used in some shooting modes (☐ 248).
- Illuminator has turned off automatically. Illuminator may become hot with continued use; wait for it to cool down.

Image size can not be changed: An NEF (RAW) option is selected for image quality (☐ 60).

Camera is slow to record photos:

- Depending on shooting conditions and memory card performance, access lamp may light for up to about a minute after shooting ends in continuous release modes.
- Turn long exposure noise reduction off (☐ 179).

Noise (bright spots, randomly-spaced bright pixels, fog, or lines) appear in photos:

- Choose lower ISO sensitivity or turn high ISO noise reduction on (☐ 180).
- Shutter speed is slower than 1 s: use long exposure noise reduction (☐ 179).
- Turn **Active D-Lighting** off to avoid heightening the effects of noise (☐ 95).

No photo taken when remote control shutter-release button is pressed:

- Replace battery in remote control (☐ 237).
- Choose remote control release mode (☐ 70).
- Flash is charging (☐ 23).
- Time selected for Custom Setting c4 (**Remote on duration (ML-L3)**, ☐ 187) has elapsed.
- Bright light is interfering with ML-L3 remote control.

Beep does not sound:

- **Off** is selected for Custom Setting d1 (**Beep**; ☐ 187).
- Camera is in quiet shutter-release mode (☐ 48), or movie is being recorded (☐ 126).
- **MF** or **AF-C** is selected as the focus mode or subject moves when **AF-A** is selected (☐ 51).

Smudges appear in photographs: Clean front and rear lens elements. If problem persists, perform image sensor cleaning (☐ 241).

Date is not imprinted on photos: An NEF (RAW) option is selected for image quality (☐ 60, 190).

Sound is not recorded with movies: **Microphone off** is selected for **Movie settings > Microphone** (☐ 128).

Flicker or banding appears during live view or movie recording: Choose an option for **Flicker reduction** that matches the frequency of the local AC power supply (☐ 200).

Menu item can not be selected: Some options are not available in all modes.

Shooting (P, S, A, M)

Shutter-release disabled:

- Non-CPU lens is attached: rotate camera mode dial to **M** (☐ 228).
 - Mode dial rotated to **S** after shutter speed of “Bulb” or “Time” selected in mode **M**: choose new shutter speed (☐ 85).
 - If white-balance bracketing is active, shutter release will be disabled and viewfinder exposure-count display will flash if there is insufficient space on memory card to record all images in bracketing sequence. Insert new memory card.
-

Full range of shutter speeds not available:

- Flash in use (☐ 66).
 - When **On** is selected for **Movie settings > Manual movie settings** in the shooting menu, the range of available shutter speed varies with the frame rate (☐ 129).
-

Can not select desired aperture: Range of available apertures varies with lens used.

Colors are unnatural:

- Adjust white balance to match light source (☐ 101).
 - Adjust **Set Picture Control** settings (☐ 111).
-

Can not measure white balance: Subject is too dark or too bright (☐ 106).

Image can not be selected as source for preset white balance: Image was not created with D5300 (☐ 107).

Effects of Picture Control differ from image to image: **A** (auto) is selected for sharpening, contrast, or saturation. For consistent results over a series of photos, choose another setting (☐ 113).

Metering can not be changed: Autoexposure lock is in effect (☐ 91).

Exposure compensation can not be used: Choose mode **P, S, or A** (☐ 82, 92).

Noise (reddish areas or other artifacts) appears in long time-exposures: Turn long-exposure noise reduction on (☐ 179).

Playback

NEF (RAW) image is not played back: Photo was taken at image quality of NEF (RAW)+JPEG (☐ 60).

Some pictures are not displayed during playback: Select **All** for **Playback folder**. Note that **Current** is automatically selected after photograph is taken (☐ 175).

“Tall” (portrait) orientation photos are displayed in “wide” (landscape) orientation:

- Select **On** for **Rotate tall** (☐ 176).
 - Photo was taken with **Off** selected for **Auto image rotation** (☐ 202).
 - Photo is displayed in image review (☐ 176).
 - Camera was pointed up or down when photo was taken (☐ 202).
-

Can not delete picture:

- Picture is protected: remove protection (☞ 143).
- Memory card is locked (☞ 12).

Can not retouch picture: Photo can not be further edited with this camera (☞ 205).

Can not change print order:

- Memory card is full: delete pictures (☞ 15, 146).
- Memory card is locked (☞ 12).

Can not select photo for printing: Photo is in NEF (RAW) format. Create JPEG copy using **NEF (RAW) processing** or transfer to computer and print using supplied software or Capture NX 2 (☞ 153, 213, 236).

Picture is not displayed on TV:

- Choose correct video mode (☞ 202) or output resolution (☞ 166).
- A/V (☞ 164) or HDMI (☞ 165) cable is not correctly connected.

Camera does not respond to remote control for HDMI-CEC television:

- Select **On** for **HDMI > Device control** in the setup menu (☞ 166).
- Adjust HDMI-CEC settings for the television as described in documentation provided with the device.

Can not transfer photos to computer: OS not compatible with camera or transfer software. Use card reader to copy photos to computer (☞ 152).

Photos are not displayed in Capture NX 2: Update to latest version (☞ 236).

Image Dust Off option in Capture NX 2 does not have desired effect: Image sensor cleaning changes the position of dust on the image sensor. Image Dust Off reference data recorded before image sensor cleaning is performed can not be used with photographs taken after image sensor cleaning is performed. Image Dust Off reference data recorded after image sensor cleaning is performed can not be used with photographs taken before image sensor cleaning is performed (☞ 199).

Location Data

The camera is unable or slow to acquire a satellite signal: Local geographic and atmospheric conditions may prevent or delay the acquisition of location data. For best results, choose a location with an unobstructed view of the sky. The built-in location data unit may take some time to acquire a signal immediately after the battery is inserted or when the record location data function is enabled for the first time, or after an extended period of disuse. Update the assisted GPS file (☐ 80).

Location data are not recorded with photographs: Check signal strength (☐ 75). The camera will only record location data if a 📶 or 📶 indicator appears in the information display; data will not be recorded if the indicator is flashing.

Location data are incorrect: The accuracy of location data may vary by up to several hundred meters depending signal quality and local topographic conditions.

Can not update the assisted GPS file:

- Confirm that the camera clock is set (☐ 201).
 - Confirm that the memory card inserted in the camera contains an assisted GPS file and that the file is in the correct folder (☐ 80).
 - The file may be corrupt. Download the file again.
-

Can not start a new track log:

- Confirm that the camera clock is set (☐ 201).
 - If the camera is already recording a track log, select **Location data > Create log > End** to end the current log before starting a new log.
 - The memory card is locked, full, or not inserted (☐ 12, 15), or the maximum number of log files (36 files per day, with a maximum total of 100 files per card) has been reached. If the maximum number of files is exceeded, format the current memory card or insert another card; if the card is full, insert another card or delete unwanted files.
-

Wi-Fi (Wireless Networks)

Smart devices do not display the camera SSID (network name):

- Confirm that **Enable** is selected for **Wi-Fi > Network connection** in the camera setup menu (☐ 169).
 - Try turning the smart device Wi-Fi off and then on again.
-

Miscellaneous




Date of recording is not correct: Set camera clock (☐ 15, 201).

Menu item can not be selected: Some options are not available at certain combinations of settings or when no memory card is inserted (☐ 12, 205, 248).

Error Messages

This section lists the indicators and error messages that appear in the viewfinder and monitor.

Warning Icons

A flashing  in the monitor or  in the viewfinder indicates that a warning or error message can be displayed in the monitor by pressing the  (?) button.

Indicator		Solution	
Monitor	Viewfinder		
Lock lens aperture ring at minimum aperture (largest f/-number).	  (flashes)	Set lens aperture ring to minimum aperture (highest f-number).	227
Lens not attached	 - /  (flashes)	<ul style="list-style-type: none"> Attach non-IX NIKKOR lens. If non-CPU lens is attached, select mode M. 	226 87
Before taking photos, rotate the zoom ring to extend the lens.	 - (flashes)	A lens with a retractable lens barrel button is attached with the lens barrel retracted. Press the retractable lens barrel button and rotate the zoom ring to extend the lens.	14
Shutter release disabled. Recharge battery.	 /  (flashes)	Turn camera off and recharge or replace battery.	2, 11
This battery cannot be used. Choose battery designated for use in this camera.	 (flashes)	Use Nikon-approved battery.	236
Initialization error. Turn camera off and then on again.	 /     (flashes)	Turn camera off, remove and replace battery, and then turn camera on again.	2, 11
Battery level is low. Complete operation and turn camera off immediately.	—	End cleaning and turn camera off and recharge or replace battery.	244
Clock not set	—	Set camera clock.	15, 201
No SD card inserted	 -  - /  (flashes)	Turn camera off and confirm that card is correctly inserted.	12
Memory card is locked. Slide lock to “write” position.	   (flashes)	Memory card is locked (write protected). Slide card write-protect switch to “write” position.	12
This memory card cannot be used. Card may be damaged. Insert another card.	  /    (flashes)	<ul style="list-style-type: none"> Use approved card. Format card. If problem persists, card may be damaged. Contact Nikon-authorized service representative. Error creating new folder. Delete files or insert new memory card. Insert new memory card. Eye-Fi card is still emitting wireless signal after Disable has been selected for Eye-Fi upload. To terminate wireless transmission, turn the camera off and remove the card. 	238 196 12, 146 12 204
Not available if Eye-Fi card is locked.	  /    (flashes)	Eye-Fi card is locked (write protected). Slide card write-protect switch to “write” position.	12

Indicator		Solution	☐
Monitor	Viewfinder		
This card is not formatted. Format the card.	(F or) (flashes)	Format card or turn camera off and insert new memory card.	12, 196
Card is full	FuL/B/? (flashes)	<ul style="list-style-type: none"> Reduce quality or size. Delete photographs. Insert new memory card. 	59 146 12
—	● (flashes)	Camera can not focus using autofocus. Change composition or focus manually.	21,52, 57
Subject is too bright	? (flashes)	<ul style="list-style-type: none"> Use a lower ISO sensitivity. Use commercial ND filter. In mode: <ul style="list-style-type: none"> S Increase shutter speed A Choose a smaller aperture (higher f-number) Q Choose another shooting mode 	67 236 85 86 3
Subject is too dark		<ul style="list-style-type: none"> Use a higher ISO sensitivity. Use flash. In mode: <ul style="list-style-type: none"> S Lower shutter speed A Choose a larger aperture (lower f-number) 	67 62 85 86
No “Bulb” in S mode	b u l b (flashes)	Change shutter speed or select mode M.	85, 87
No “Time” in S mode	- - (flashes)		
No “Bulb” in HDR mode	b u l b (flashes)	<ul style="list-style-type: none"> Change shutter speed. Turn HDR off. 	87, 88 96
No “Time” in HDR mode	- - (flashes)		
Interval timer shooting	—	Menus and playback are not available while interval timer photography is in progress. Turn camera off.	68
—	⚡ (flashes)	Flash has fired at full power. Check photo in monitor; if underexposed, adjust settings and try again.	—
—	⚡/? (flashes)	<ul style="list-style-type: none"> Use the flash. Change distance to subject, aperture, flash range, or ISO sensitivity. Lens focal length is less than 18 mm: use a longer focal length. Optional SB-400 or SB-300 flash unit attached: flash is in bounce position or focus distance is very short. Continue shooting; if necessary, increase focus distance to prevent shadows from appearing in photograph. 	62 66,67, 86 — —





























Indicator		Solution	📖
Monitor	Viewfinder		
Flash error	Ⓜ (flashes)	Error occurred updating firmware for optional flash unit. Contact Nikon-authorized service representative.	—
Error. Press shutter release button again.	Err (flashes)	Release shutter. If error persists or appears frequently, consult Nikon-authorized service representative.	—
Start-up error. Contact a Nikon-authorized service representative.		Consult Nikon-authorized service representative.	—
Metering error			
Unable to start live view. Please wait for camera to cool.	—	Wait for the internal circuits to cool before resuming live view or movie recording.	124, 127
Folder contains no images.	—	Folder selected for playback contains no images (note that this message will be displayed if memory card is inserted after Current is selected for Playback folder in playback menu and playback started before any pictures are taken). Insert another memory card or select All for Playback folder .	12, 175
Cannot display this file.	—	File can not be played back on camera.	—
Cannot select this file.	—	Images created with other devices can not be retouched.	206
No image for retouching.	—	Memory card does not contain NEF (RAW) images for use with NEF (RAW) processing .	213
Could not connect; multiple devices detected. Try again later.	—	Multiple smart devices are attempting to connect to camera simultaneously. Wait a few minutes before trying again.	168
Error	—	Select Disable for Wi-Fi > Network connection , then select Enable again.	172
Network access not available until camera cools.	—	Turn camera off and try again after waiting for camera to cool.	—
Check printer.	—	Check printer. To resume, select Continue (if available).	—*
Check paper.	—	Paper is not selected size. Insert paper of correct size and select Continue .	—*
Paper jam.	—	Clear jam and select Continue .	—*
Out of paper.	—	Insert paper of selected size and select Continue .	—*
Check ink supply.	—	Check ink. To resume, select Continue .	—*
Out of ink.	—	Replace ink and select Continue .	—*




* See printer manual for more information.



Specifications

■ Nikon D5300 Digital Camera

Type	
Type	Single-lens reflex digital camera
Lens mount	Nikon F mount (with AF contacts)
Effective angle of view	Nikon DX format; focal length equivalent to approx. 1.5× that of lenses with FX format angle of view
Effective pixels	
Effective pixels	24.2 million
Image sensor	
Image sensor	23.5 × 15.6 mm CMOS sensor
Total pixels	24.78 million
Dust-reduction System	Image sensor cleaning, Image Dust Off reference data (optional Capture NX 2 software required)
Storage	
Image size (pixels)	<ul style="list-style-type: none">6000 × 4000 (Large)4496 × 3000 (Medium)2992 × 2000 (Small)
File format	<ul style="list-style-type: none">NEF (RAW): 12- or 14 bit, compressedJPEG: JPEG-Baseline compliant with fine (approx. 1 : 4), normal (approx. 1 : 8), or basic (approx. 1 : 16) compressionNEF (RAW)+JPEG: Single photograph recorded in both NEF (RAW) and JPEG formats
Picture Control System	Standard, Neutral, Vivid, Monochrome, Portrait, Landscape; selected Picture Control can be modified; storage for custom Picture Controls
Media	SD (Secure Digital) and UHS-I compliant SDHC and SDXC memory cards
File system	DCF (Design Rule for Camera File System) 2.0, DPOF (Digital Print Order Format), Exif (Exchangeable Image File Format for Digital Still Cameras) 2.3, PictBridge
Viewfinder	
Viewfinder	Eye-level pentamirror single-lens reflex viewfinder
Frame coverage	Approx. 95% horizontal and 95% vertical
Magnification	Approx. 0.82 × (50 mm f/1.4 lens at infinity, -1.0 m^{-1})
Eyepoint	18 mm (-1.0 m^{-1} ; from center surface of viewfinder eyepiece lens)
Diopter adjustment	-1.7 – $+1.0 \text{ m}^{-1}$
Focusing screen	Type B BriteView Clear Matte Mark VII screen
Reflex mirror	Quick return
Lens aperture	Instant return, electronically controlled

Lens	
Compatible lenses	Autofocus is available with AF-S, AF-P, and AF-I lenses. Autofocus is not available with other type G and D lenses, AF lenses (IX NIKKOR and lenses for the F3AF are not supported), and AI-P lenses. Non-CPU lenses can be used in mode M , but the camera exposure meter will not function. The electronic rangefinder can be used with lenses that have a maximum aperture of f/5.6 or faster.
Shutter	
Type	Electronically-controlled vertical-travel focal-plane shutter
Speed	$1/4000$ – 30 s in steps of $1/3$ or $1/2$ EV; Bulb; Time
Flash sync speed	$X=1/200$ s; synchronizes with shutter at $1/200$ s or slower
Release	
Release mode	 (single frame),  (continuous L),  (continuous H),  (quiet shutter release),  (self-timer),  2s (delayed remote; ML-L3),  (quick-response remote; ML-L3); interval timer photography supported
Frame advance rate	<ul style="list-style-type: none">  L: Up to 3 fps  H: Up to 5 fps (JPEG and 12-bit NEF/RAW) or 4 fps (14-bit NEF/RAW) Note: Frame rates assume continuous-servo AF, manual or shutter-priority auto exposure, a shutter speed of $1/250$ s or faster, Release selected for Custom Setting a1 (AF-C priority selection), and other settings at default values.
Self-timer	2 s, 5 s, 10 s, 20 s; 1–9 exposures
Exposure	
Metering mode	TTL exposure metering using 2016-pixel RGB sensor
Metering method	<ul style="list-style-type: none"> Matrix metering: 3D color matrix metering II (type G, E, and D lenses); color matrix metering II (other CPU lenses) Center-weighted metering: Weight of 75% given to 8-mm circle in center of frame Spot metering: Meters 3.5-mm circle (about 2.5% of frame) centered on selected focus point
Range (ISO 100, f/1.4 lens, 20 °C/68 °F)	<ul style="list-style-type: none"> Matrix or center-weighted metering: 0–20 EV Spot metering: 2–20 EV
Exposure meter coupling	CPU
Mode	Auto modes ( auto;  auto, flash off); programmed auto with flexible program (P); shutter-priority auto (S); aperture-priority auto (A); manual (M); scene modes ( portrait;  landscape;  child;  sports;  close up;  night portrait;  night landscape;  party/indoor;  beach/snow;  sunset;  dusk/dawn;  pet portrait;  candlelight;  blossom;  autumn colors;  food); special effects modes (night vision; color sketch; toy camera effect; miniature effect; selective color; silhouette; high key; low key; HDR painting)
Exposure compensation	Can be adjusted by –5 – +5 EV in increments of $1/3$ or $1/2$ EV in P , S , A , and M modes
Bracketing	<ul style="list-style-type: none"> Exposure bracketing: 3 shots in steps of $1/3$ or $1/2$ EV White balance bracketing: 3 shots in steps of 1 Active D-Lighting bracketing: 2 shots
Exposure lock	Luminosity locked at detected value with AF-L AF-L ( AF-L) button

Exposure	
ISO sensitivity (Recommended Exposure Index)	ISO 100 – 12800 in steps of $\frac{1}{3}$ EV. Can also be set to approx. 0.3, 0.7, or 1 EV (ISO 25600 equivalent) above ISO 12800; auto ISO sensitivity control available
Active D-Lighting	☀️ A Auto, ☀️ H ⁺ Extra high, ☀️ H High, ☀️ N Normal, ☀️ L Low, OFF Off
Focus	
Autofocus	Nikon Multi-CAM 4800DX autofocus sensor module with TTL phase detection, 39 focus points (including 9 cross-type sensor), and AF-assist illuminator (range approx. 0.5–3 m/1 ft 8 in.–9 ft 10 in.)
Detection range	–1 – +19 EV (ISO 100, 20 °C/68 °F)
Lens servo	<ul style="list-style-type: none"> • Autofocus (AF): Single-servo AF (AF-S); continuous-servo AF (AF-C); auto AF-S/AF-C selection (AF-A); predictive focus tracking activated automatically according to subject status • Manual focus (MF): Electronic rangefinder can be used
Focus point	Can be selected from 39 or 11 focus points
AF-area mode	Single-point AF, 9-, 21-, or 39- point dynamic-area AF, 3D-tracking, auto-area AF
Focus lock	Focus can be locked by pressing shutter-release button halfway (single-servo AF) or by pressing  (AF-L) button
Flash	
Built-in flash	 : Auto flash with auto pop-up P, S, A, M,  : Manual pop-up with button release
Guide Number	Approx. 12/39, 13/43 with manual flash (m/ft, ISO 100, 20 °C/68 °F)
Flash control	TTL: i-TTL flash control using 2016-pixel RGB sensor is available with built-in flash and SB-910, SB-900, SB-800, SB-700, SB-600, SB-400, or SB-300; i-TTL balanced fill-flash for digital SLR is used with matrix and center-weighted metering, standard i-TTL flash for digital SLR with spot metering
Flash mode	Auto, auto with red-eye reduction, auto slow sync, auto slow sync with red-eye reduction, fill-flash, red-eye reduction, slow sync, slow sync with red-eye reduction, rear-curtain with slow sync, rear-curtain sync, off
Flash compensation	–3 – +1 EV in increments of $\frac{1}{3}$ or $\frac{1}{2}$ EV
Flash-ready indicator	Lights when built-in flash or optional flash unit is fully charged; flashes after flash is fired at full output
Accessory shoe	ISO 518 hot-shoe with sync and data contacts and safety lock
Nikon Creative Lighting System (CLS)	Advanced Wireless Lighting supported with SB-910, SB-900, SB-800, or SB-700 as a master flash or SU-800 as commander; Flash Color Information Communication supported with all CLS-compatible flash units
Sync terminal	AS-15 sync terminal adapter (available separately)
White balance	
White balance	Auto, incandescent, fluorescent (7 types), direct sunlight, flash, cloudy, shade, preset manual, all except preset manual with fine-tuning.

Live view	
Lens servo	<ul style="list-style-type: none"> • Autofocus (AF): Single-servo AF (AF-S); full-time-servo AF (AF-F) • Manual focus (MF)
AF-area mode	Face-priority AF, wide-area AF, normal-area AF, subject-tracking AF
Autofocus	Contrast-detect AF anywhere in frame (camera selects focus point automatically when face-priority AF or subject-tracking AF is selected)
Automatic scene selection	Available in  and  modes
Movie	
Metering	TTL exposure metering using main image sensor
Metering method	Matrix
Frame size (pixels) and frame rate	<ul style="list-style-type: none"> • 1920 × 1080, 60p (progressive)/50p/30p/25p/24p, ★ high/normal • 1280 × 720, 60p/50p, ★ high/normal • 640 × 424, 30p/25p, ★ high/normal <p>Frame rates of 30p (actual frame rate 29.97 fps) and 60p (actual frame rate 59.94 fps) are available when NTSC is selected for video mode. 25p and 50p are available when PAL is selected for video mode. Actual frame rate when 24p is selected is 23.976 fps.</p>
File format	MOV
Video compression	H.264/MPEG-4 Advanced Video Coding
Audio recording format	Linear PCM
Audio recording device	Built-in or external stereo microphone; sensitivity adjustable
ISO sensitivity	ISO 100–12800; can also be set to approx. 0.3, 0.7, or 1 EV (ISO 25600 equivalent) above ISO 12800
Monitor	
Monitor	8.1 cm/3.2-in. (3 : 2), approx. 1037k-dot (720 × 480 × 3 = 1,036,800 dots), vari-angle TFT monitor with 170 ° viewing angle, approx. 100% frame coverage, and brightness adjustment
Playback	
Playback	Full-frame and thumbnail (4, 12, or 80 images or calendar) playback with playback zoom, movie playback, photo and/or movie slide shows, histogram display, highlights, auto image rotation, picture rating, and image comment (up to 36 characters)
Interface	
USB	Hi-Speed USB
Video output	NTSC, PAL
HDMI output	Type C mini-pin HDMI connector
Accessory terminal	Wireless remote controllers: WR-1, WR-R10 (available separately) Remote cords: MC-DC2 (available separately) GPS units: GP-1/GP-1A (available separately)
Audio input	Stereo mini-pin jack (3.5mm diameter); supports optional ME-1 stereo microphones

Wireless	
Standards	IEEE 802.11b, IEEE 802.11g
Communications protocols	<ul style="list-style-type: none"> • IEEE 802.11b: DSSS/CCK • IEEE 802.11g: OFDM
Operating frequency	2412–2462 MHz (channels 1–11)
Range (line of sight)	Approximately 30 m/98 ft (assumes no interference; range may vary with signal strength and presence or absence of obstacles)
Data rate	54 Mbps Maximum logical data rates according to IEEE standard. Actual rates may differ.
Security	<ul style="list-style-type: none"> • Authentication: Open system, WPA2-PSK • Encryption: AES
Wireless setup	Supports WPS
Access protocols	Infrastructure
Location data	
Receiving frequency	1575.42 MHz (C/A code)
Geodesics	WGS84
Supported languages	
Supported languages	Arabic, Bengali, Chinese (Simplified and Traditional), Czech, Danish, Dutch, English, Finnish, French, German, Greek, Hindi, Hungarian, Indonesian, Italian, Japanese, Korean, Norwegian, Persian, Polish, Portuguese (Portugal and Brazil), Romanian, Russian, Spanish, Swedish, Tamil, Thai, Turkish, Ukrainian, Vietnamese
Power source	
Battery	One rechargeable Li-ion EN-EL14a battery
AC adapter	EH-5b AC adapter; requires EP-5A power connector (available separately)
Tripod socket	
Tripod socket	¹ / ₄ in. (ISO 1222)
Dimensions/weight	
Dimensions (W × H × D)	Approx. 125 × 98 × 76 mm (4.9 × 3.9 × 3 in.)
Weight	Approx. 530 g (1 lb 2.7 oz) with battery and memory card but without body cap; approx. 480 g/1 lb 0.9 oz (camera body only)
Operating environment	
Temperature	0 °C–40 °C (+32 °F–104 °F)
Humidity	85% or less (no condensation)

- Unless otherwise stated, all measurements are performed in conformity with Camera and Imaging Products Association (CIPA) standards or guidelines.
- All figures are for a camera with a fully-charged battery.
- Nikon reserves the right to change the appearance and specifications of the hardware and software described in this manual at any time and without prior notice. Nikon will not be held liable for damages that may result from any mistakes that this manual may contain.

■ ■ *MH-24 Battery Charger*

Rated input	AC 100–240 V, 50/60 Hz, 0.2 A maximum
Rated output	DC 8.4 V/0.9 A
Supported batteries	Nikon Rechargeable Li-ion Battery EN-EL14a
Charging time	Approx. 1 hour and 50 minutes at an ambient temperature of 25 °C/77 °F when no charge remains
Operating temperature	0 °C–40 °C (+32 °F–104 °F)
Dimensions (W × H × D)	Approx. 70 × 26 × 97 mm (2.8 × 1.0 × 3.8 in.), excluding plug adapter
Weight	Approx. 96 g (3.4 oz), excluding plug adapter

■ ■ *EN-EL14a Rechargeable Li-ion Battery*

Type	Rechargeable lithium-ion battery
Rated capacity	7.2 V/1230 mAh
Operating temperature	0 °C–40 °C (+32 °F–104 °F)
Dimensions (W × H × D)	Approx. 38 × 53 × 14 mm (1.5 × 2.1 × 0.6 in.)
Weight	Approx. 49 g (1.7 oz), excluding terminal cover

Nikon reserves the right to change the appearance and specifications of the hardware and software described in this manual at any time and without prior notice. Nikon will not be held liable for damages that may result from any mistakes that this manual may contain.

■ Supported Standards

- **DCF Version 2.0:** The Design Rule for Camera File Systems (DCF) is a standard widely used in the digital camera industry to ensure compatibility among different makes of camera.
- **DPOF: Digital Print Order Format (DPOF)** is an industry-wide standard that allows pictures to be printed from print orders stored on the memory card.
- **Exif version 2.3:** The D5300 supports Exif (**Exchangeable Image File Format** for Digital Still Cameras) version 2.3, a standard in which information stored with photographs is used for optimal color reproduction when the images are output on Exif-compliant printers.
- **PictBridge:** A standard developed through cooperation with the digital camera and printer industries, allowing photographs to be output directly to a printer without first transferring them to a computer.
- **HDMI: High-Definition Multimedia Interface** is a standard for multimedia interfaces used in consumer electronics and AV devices capable of transmitting audiovisual data and control signals to HDMI-compliant devices via a single cable connection.

Trademark Information

IOS is a trademark or registered trademark of Cisco Systems, Inc., in the United States and/or other countries and is used under license. Mac OS and OS X are registered trademarks of Apple Inc. in the United States and/or other countries. Microsoft, Windows, and Windows Vista are either registered trademarks, or trademarks of Microsoft Corporation in the United States and/or other countries. PictBridge logo is a trademark. The SD, SDHC, and SDXC logos are trademarks of the SD-3C, LLC. HDMI, the HDMI logo and High-Definition Multimedia Interface are trademarks or registered trademarks of HDMI Licensing LLC.

HDMI

Wi-Fi and the Wi-Fi logo are trademarks or registered trademarks of the Wi-Fi Alliance. All other trade names mentioned in this manual or the other documentation provided with your Nikon product are trademarks or registered trademarks of their respective holders.

Conformity Marking

The standards with which the camera complies can be viewed using the **Conformity marking** option in the setup menu (□ 204).

FreeType License (FreeType2)

Portions of this software are copyright © 2013 The FreeType Project (<http://www.freetype.org>). All rights reserved.

MIT License (HarfBuzz)

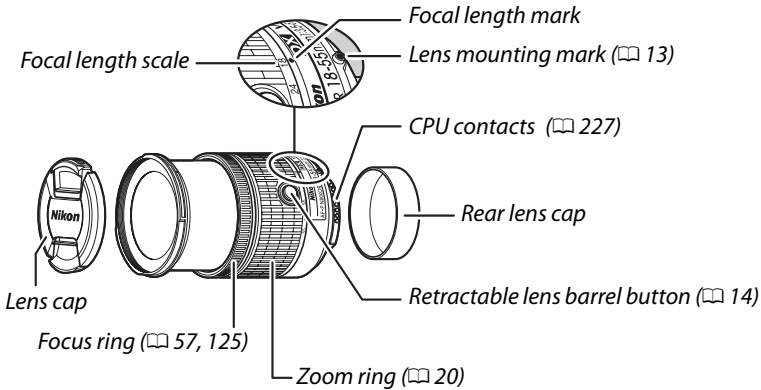
Portions of this software are copyright © 2013 The HarfBuzz Project (<http://www.freedesktop.org/wiki/Software/HarfBuzz>). All rights reserved.

Lens Kits

The camera can be purchased as a kit with the lens listed below.

AF-P DX NIKKOR 18–55mm f/3.5–5.6G VR and **AF-P DX NIKKOR 18–55mm f/3.5–5.6G**

These retractable lenses are for use exclusively with DX format Nikon digital SLR cameras; SLR film cameras and D4-series, D3-series, D2-series, D1-series, D800-series, D700, D610, D600, D300-series, D200, D100, D90, D80, D70-series, D60, D50, D40-series, D7000, D5100, D5000, D3200, D3100, D3000 digital SLR cameras are not supported. The parts of the lens are listed below.



■ Focus

The focus mode can be selected using camera controls (□ 51).

Autofocus

Focus is adjusted automatically when the camera is in autofocus mode (□ 51). The focus ring can also be used to focus the camera if the shutter-release button is kept pressed halfway (or if the AF-ON button is kept pressed); this is known as “autofocus with manual override” (M/A). Autofocus will resume when the shutter-release button is pressed halfway (or the AF-ON button is pressed) a second time. Note that touching the focus ring while autofocus is in effect will change the focus position.

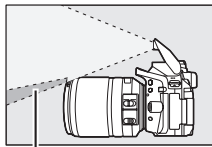
Manual Focus

When the camera is in manual focus mode, focus can be adjusted by rotating the lens focus ring (□ 57). When the camera is off or the standby timer has expired, the focus ring can not be used to focus and rotating the zoom ring will change the focus position; before focusing, turn the camera on or press the shutter-release button to reactivate the standby timer.

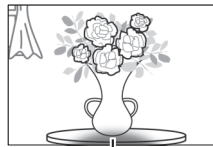
Users of D810-series, Df, D750, D7200, D7100, and D5200 cameras should note that if the standby timer is allowed to expire, the focus position will change when the timer is restarted. Refocus before shooting. Longer standby times are recommended for manual focus and in other situations in which you may not release the shutter immediately after focusing.

■ Using the Built-in Flash

When using the built-in flash, be sure the subject is at a range of at least 0.6 m (2 ft) and remove lens hoods to prevent vignetting (shadows created where the end of the lens obscures the built-in flash).



Shadow



Vignetting

Camera	Zoom position	Minimum distance without vignetting
D5500/D5300/D5200/D3300	18 mm	1.0 m/3 ft 4 in.
	24, 35, 45, and 55 mm	No vignetting

■ ■ **Vibration Reduction (VR, AF-P DX NIKKOR 18–55mm f/3.5–5.6G VR Only)**

When an AF-P DX NIKKOR 18–55mm f/3.5–5.6G VR is mounted on the camera, vibration reduction can be enabled or disabled using the **Optical VR** option in the shooting menu (☐ 181). If **On** is selected, vibration reduction will take effect whenever the shutter-release button is pressed halfway. Vibration reduction reduces blur caused by camera shake, allowing shutter speeds up to 4.0 stops slower than would otherwise be the case, increasing the range of shutter speeds available. The effects of VR on shutter speed are measured according to Camera and Imaging Products Association (CIPA) standards; FX-format lenses are measured using FX-format digital cameras, DX-format lenses using DX-format cameras. Zoom lenses are measured at maximum zoom.

✓ **Vibration Reduction**

- When using vibration reduction, press the shutter-release button halfway and wait for the image in the viewfinder to stabilize before pressing the shutter-release button the rest of the way down.
- When vibration reduction is active, the image in the viewfinder may jiggle after the shutter is released. This does not indicate a malfunction.
- When the camera is panned, vibration reduction applies only to motion that is not part of the pan (if the camera is panned horizontally, for example, vibration reduction will be applied only to vertical shake), making it much easier to pan the camera smoothly in a wide arc.
- If the camera is equipped with a built-in flash, vibration reduction will be disabled while the flash charges.
- Vibration reduction is generally recommended when the camera is mounted on a tripod, although you may prefer to turn it off depending on shooting conditions and the type of tripod.

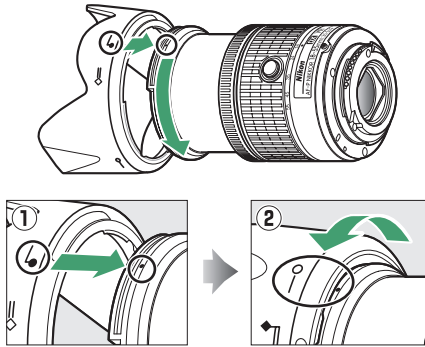
■ ■ *Supplied Accessories*

- 55 mm snap-on Front Lens Cap LC-55A
- Rear Lens Cap

■ ■ *Compatible Accessories*

- 55 mm screw-on filters
- Rear Lens Cap LF-4
- Lens Case CL-0815
- Bayonet Hood HB-N106

Align the lens hood mounting mark (●) with the lens hood alignment mark (↵) as shown in Figure ① and then rotate the hood (②) until the ● mark is aligned with the lens hood lock mark (—○).



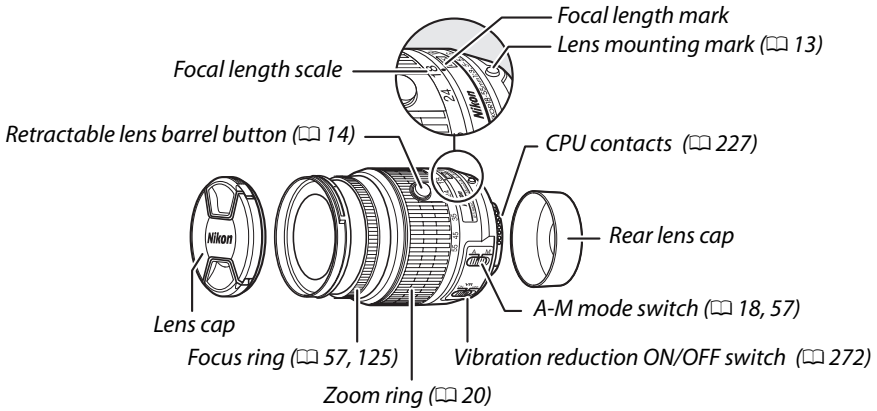
When attaching or removing the hood, hold it near the symbol on its base and avoid gripping it too tightly. Vignetting may occur if the hood is not correctly attached. The hood can be reversed and mounted on the lens when not in use.

■ Specifications

Type	Type G AF-P DX lens with built-in CPU and F mount
Focal length	18–55 mm
Maximum aperture	f/3.5–5.6
Lens construction	12 elements in 9 groups (2 aspherical lens elements)
Angle of view	76° – 28° 50′
Focal length scale	Graduated in millimeters (18, 24, 35, 45, 55)
Distance information	Output to camera
Zoom	Manual zoom using independent zoom ring
Focusing	Autofocus controlled by stepping motor; separate focus ring for manual focus
Vibration reduction (AF-P DX NIKKOR 18–55mm f/3.5–5.6G VR only)	Lens shift using voice coil motors (VCMs)
Minimum focus distance	0.25 m (0.9 ft) from focal plane (□ 58) at all zoom positions
Diaphragm blades	7 (rounded diaphragm opening)
Diaphragm	Fully automatic
Aperture range	<ul style="list-style-type: none">• 18 mm focal length: f/3.5–22• 55 mm focal length: f/5.6–38 The minimum aperture displayed may vary depending on the size of the exposure increment selected with the camera.
Metering	Full aperture
Filter-attachment size	55 mm (P = 0.75 mm)
Dimensions	Approx. 64.5 mm maximum diameter × 62.5 mm (distance from camera lens mount flange)
Weight	<ul style="list-style-type: none">• AF-P DX NIKKOR 18–55mm f/3.5–5.6G VR: Approx. 205 g (7.3 oz)• AF-P DX NIKKOR 18–55mm f/3.5–5.6G: Approx. 195 g (6.9 oz)

AF-S DX NIKKOR 18–55mm f/3.5–5.6G VR II

The AF-S DX NIKKOR 18–55mm f/3.5–5.6G VR II is a retractable lens for use exclusively with DX format Nikon digital SLR cameras. The parts of the lens are listed below.

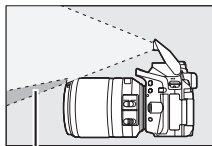


■ Focus

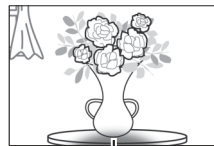
Focus mode is determined by the camera focus mode and the position of the lens A-M mode switch (□ 51, 57).

■ Using the Built-in Flash

When using the built-in flash, be sure the subject is at a range of at least 0.6 m (2 ft) and remove lens hoods to prevent vignetting (shadows created where the end of the lens obscures the built-in flash).



Shadow



Vignetting

■ ■ **Vibration Reduction (VR)**

Vibration reduction can be enabled by sliding the vibration reduction switch to **ON** and takes effect whenever the shutter-release button is pressed halfway. Vibration reduction reduces blur caused by camera shake, allowing shutter speeds up to 4.0 stops slower than would otherwise be the case (as measured at 55 mm with a DX-format camera according to Camera and Imaging Products Association [CIPA] standards; effects vary with the photographer and shooting conditions). This increases the range of shutter speeds available.



✓ **Vibration Reduction**

- When using vibration reduction, press the shutter-release button halfway and wait for the image in the viewfinder to stabilize before pressing the shutter-release button the rest of the way down.
- When vibration reduction is active, the image in the viewfinder may jiggle after the shutter is released. This does not indicate a malfunction.
- When the camera is panned, vibration reduction applies only to motion that is not part of the pan (if the camera is panned horizontally, for example, vibration reduction will be applied only to vertical shake), making it much easier to pan the camera smoothly in a wide arc.
- Do not turn the camera off or remove the lens while vibration reduction is in effect.
- If the camera is equipped with a built-in flash, vibration reduction will be disabled while the flash charges.
- Select **OFF** when the camera is mounted on a tripod unless the tripod head is unsecured or the camera is mounted on a monopod, in which case **ON** is recommended.

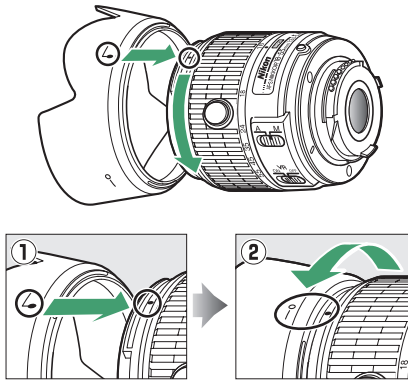
■ Supplied Accessories

- 52 mm snap-on Front Lens Cap LC-52
- Rear Lens Cap

■ Compatible Accessories

- 52 mm screw-on filters
- Rear Lens Cap LF-4
- Flexible Lens Pouch CL-0815
- Bayonet Hood HB-69

Align the lens hood mounting mark (●) with the lens hood alignment mark (↵) as shown in Figure ① and then rotate the hood (②) until the ● mark is aligned with the lens hood lock mark (—○).



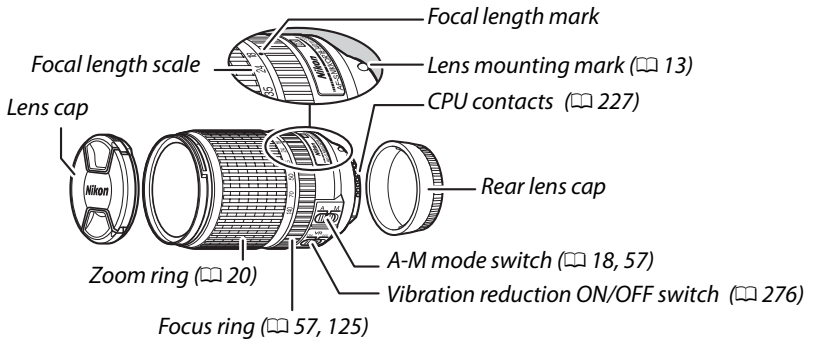
When attaching or removing the hood, hold it near the symbol on its base and avoid gripping it too tightly. Vignetting may occur if the hood is not correctly attached. The hood can be reversed and mounted on the lens when not in use.

■ Specifications

Type	Type G AF-S DX lens with built-in CPU and F mount
Focal length	18–55 mm
Maximum aperture	f/3.5–5.6
Lens construction	11 elements in 8 groups (including 1 aspherical lens element)
Angle of view	76°–28° 50′
Focal length scale	Graduated in millimeters (18, 24, 35, 45, 55)
Distance information	Output to camera
Zoom	Manual zoom using independent zoom ring
Focusing	Autofocus controlled by Silent Wave Motor and separate focus ring for manual focus
Vibration reduction	Lens shift using voice coil motors (VCMs)
Minimum focus distance	<ul style="list-style-type: none">• AF: 0.28 m (0.92 ft) from focal plane (□ 58) at all zoom positions• MF: 0.25 m (0.82 ft) from focal plane at all zoom positions
Diaphragm blades	7 (rounded diaphragm opening)
Diaphragm	Fully automatic
Aperture range	<ul style="list-style-type: none">• 18 mm focal length: f/3.5–22• 55 mm focal length: f/5.6–38 <p>The minimum aperture displayed may vary depending on the size of the exposure increment selected with the camera.</p>
Metering	Full aperture
Filter-attachment size	52 mm (P=0.75 mm)
Dimensions	Approx. 66 mm diameter × 59.5 mm (distance from camera lens mount flange when lens is retracted)
Weight	Approx. 195 g (6.9 oz)

AF-S DX NIKKOR 18–140mm f/3.5–5.6G ED VR

The AF-S DX NIKKOR 18–140mm f/3.5–5.6G ED VR, for use exclusively with DX format Nikon digital SLR cameras, is the lens generally used in this manual for illustrative purposes. The parts of the lens are listed below.



Focus

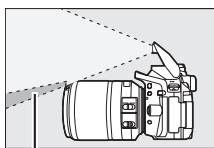
Focus mode is determined by the camera focus mode and the position of the lens A-M mode switch (pages 51, 57).

Focusing with AF-S DX NIKKOR 18–140mm f/3.5–5.6G ED VR Lenses

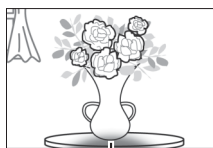
When single-servo AF (**AF-S**) is selected as the camera focus mode and the lens A-M switch is set to **A**, focus can be adjusted by keeping the shutter-release button pressed halfway after the autofocus operation is complete and manually rotating the focus ring. To refocus using autofocus, press the shutter-release button halfway again.

■ ■ Using the Built-in Flash

When using the built-in flash, be sure the subject is at a range of at least 0.6 m (2 ft) and remove lens hoods to prevent vignetting (shadows created where the end of the lens obscures the built-in flash).



Shadow



Vignetting

Camera	Zoom position	Minimum distance without vignetting
D7100/D7000/D300 series/ D200/D100	18 mm	1.0 m/3 ft 3 in.
	24–140 mm	No vignetting
D90/D80/D50	18 mm	2.5 m/8 ft 2 in.
	24 mm	1.0 m/3 ft 3 in.
	35–140 mm	No vignetting
D5500/D5300/D5200/D5100/D5000/ D3300/D3200/D3100/D3000/ D70 series/D60/D40 series	18 mm	1.0 m/3 ft 3 in.
	24 mm	
	35–140 mm	No vignetting

■ ■ Vibration Reduction (VR)

Vibration reduction can be enabled by sliding the vibration reduction switch to **ON** and takes effect whenever the shutter-release button is pressed halfway. Vibration reduction reduces blur caused by camera shake, allowing shutter speeds up to 4.0 stops slower than would otherwise be the case (as measured at 140 mm with a D300s camera according to Camera and Imaging Products Association [CIPA] standards; effects vary with the photographer and shooting conditions). This increases the range of shutter speeds available.



✔ Vibration Reduction

- When using vibration reduction, press the shutter-release button halfway and wait for the image in the viewfinder to stabilize before pressing the shutter-release button the rest of the way down.
- When vibration reduction is active, the image in the viewfinder may jiggle after the shutter is released. This does not indicate a malfunction.
- When the camera is panned, vibration reduction applies only to motion that is not part of the pan (if the camera is panned horizontally, for example, vibration reduction will be applied only to vertical shake), making it much easier to pan the camera smoothly in a wide arc.
- Do not turn the camera off or remove the lens while vibration reduction is in effect. If power to the lens is cut while vibration reduction is on, the lens may rattle when shaken. This is not a malfunction, and can be corrected by reattaching the lens and turning the camera on.
- If the camera is equipped with a built-in flash, vibration reduction will be disabled while the flash charges.
- Select **OFF** when the camera is mounted on a tripod unless the tripod head is unsecured or the camera is mounted on a monopod, in which case **ON** is recommended.

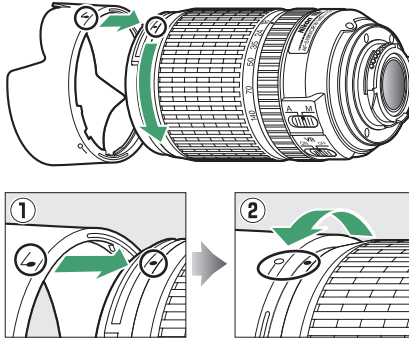
■ ■ *Supplied Accessories*

- 67 mm snap-on Front Lens Cap LC-67
- Rear Lens Cap

■ ■ *Compatible Accessories*

- 67 mm screw-on filters
- Rear Lens Cap LF-4
- Flexible Lens Pouch CL-1018
- Bayonet Hood HB-32

Align the lens hood mounting mark (●) with the lens hood alignment mark (↙) as shown in Figure ① and then rotate the hood (②) until the ● mark is aligned with the lens hood lock mark (—○).



When attaching or removing the hood, hold it near the symbol on its base and avoid gripping it too tightly. Vignetting may occur if the hood is not correctly attached. The hood can be reversed and mounted on the lens when not in use.

■ Specifications

Type	Type G AF-S DX lens with built-in CPU and F mount
Focal length	18–140 mm
Maximum aperture	f/3.5–5.6
Lens construction	17 elements in 12 groups (including 1 ED lens element, 1 aspherical lens element)
Angle of view	76° – 11° 30′
Focal length scale	Graduated in millimeters (18, 24, 35, 50, 70, 140)
Distance information	Output to camera
Zoom	Manual zoom using independent zoom ring
Focusing	Nikon Internal Focusing (IF) System with autofocus controlled by Silent Wave Motor and separate focus ring for manual focus
Vibration reduction	Lens shift using voice coil motors (VCMs)
Minimum focus distance	0.45 m (1.48 ft) from focal plane (☞ 58) at all zoom positions
Diaphragm blades	7 (rounded diaphragm opening)
Diaphragm	Fully automatic
Aperture range	<ul style="list-style-type: none">• 18 mm focal length: f/3.5–22• 140 mm focal length: f/5.6–38 The minimum aperture displayed may vary depending on the size of the exposure increment selected with the camera.
Metering	Full aperture
Filter-attachment size	67 mm (P = 0.75 mm)
Dimensions	Approx. 78 mm maximum diameter × 97 mm (distance from camera lens mount flange)
Weight	Approx. 490 g (17.3 oz)

✓ Lens Care

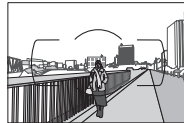
- Keep the CPU contacts clean.
- Use a blower to remove dust and lint from the lens surfaces. To remove smudges and fingerprints, apply a small amount of ethanol or lens cleaner to a soft, clean cotton cloth or lens-cleaning tissue and clean from the center outwards using a circular motion, taking care not to leave smears or touch the glass with your fingers.
- Never use organic solvents such as paint thinner or benzene to clean the lens.
- The lens hood or NC filters can be used to protect the front lens element.
- Attach the front and rear caps before placing the lens in its flexible pouch.
- When a lens hood is attached, do not pick up or hold the lens or camera using only the hood.
- If the lens will not be used for an extended period, store it in a cool, dry location to prevent mold and rust. Do not store in direct sunlight or with naphtha or camphor moth balls.
- Keep the lens dry. Rusting of the internal mechanism can cause irreparable damage.
- Leaving the lens in extremely hot locations could damage or warp parts made from reinforced plastic.

✍ A Note on Wide- and Super Wide-Angle Lenses

Autofocus may not provide the desired results in situations like those shown below.

1 Objects in the background occupy more of the focus point than the main subject:

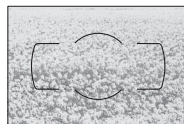
If the focus point contains both foreground and background objects, the camera may focus on the background and the subject may be out of focus.



Example: A far-off portrait subject at some distance from the background

2 The subject contains many fine details.

The camera may have difficulty focusing on subjects that lack contrast or appear smaller than objects in the background.



Example: A field of flowers

In these cases, use manual focus, or use focus lock to focus on another subject at the same distance and then recompose the photograph. For more information, see “Getting Good Results with Autofocus” (□ 52).

Memory Card Capacity

The following table shows the approximate number of pictures that can be stored on a 16 GB SanDisk Extreme Pro SDHC UHS-I card at different image quality and size settings.

Image quality	Image size	File size ¹	No. of images ¹	Buffer capacity ²
NEF (RAW), Compressed, 14-bit	—	23.8 MB	437	6
NEF (RAW), Compressed, 12-bit	—	19.0 MB	524	13
JPEG fine	Large	12.0 MB	1000	100
	Medium	7.4 MB	1700	100
	Small	3.8 MB	3300	100
JPEG normal	Large	6.3 MB	2000	100
	Medium	3.8 MB	3300	100
	Small	2.0 MB	6300	100
JPEG basic	Large	2.7 MB	3900	100
	Medium	1.9 MB	6500	100
	Small	1.0 MB	12,100	100

1 All figures are approximate. Results will vary with card type, camera settings, and scene recorded.

2 Maximum number of exposures that can be stored in memory buffer at ISO 100. Drops when long exposure noise reduction (☐ 179), auto distortion control (☐ 179), or **Print date** (☐ 190) is on.

Battery Life

The movie footage or number of shots that can be recorded with fully-charged batteries varies with the condition of the battery, temperature, the interval between shots, and the length of time menus are displayed. Sample figures for EN-EL14a (1230 mAh) batteries are given below.

- **Photographs, single-frame release mode (CIPA standard ¹):** Approximately 600 shots
- **Photographs, continuous release mode (Nikon standard ²):** Approximately 2000 shots
- **Movies:** Approximately 50 minutes at 1080/60p and 1080/50p ³
 - 1 Measured at 23 °C/73.4 °F (± 2 °C/3.6 °F) with an AF-S DX NIKKOR 18–55mm f/3.5–5.6G VR II lens under the following test conditions: lens cycled from infinity to minimum range and one photograph taken at default settings once every 30 s; after photograph is taken, monitor is turned on for 4 s; tester waits for standby timer to expire after monitor is turned off; flash fired at full power once every other shot. Live view not used.
 - 2 Measured at 20 °C/68 °F with an AF-S DX NIKKOR 18–55mm f/3.5–5.6G VR II lens under the following test conditions: vibration reduction off, continuous high-speed release mode, focus mode set to **AF-C**, image quality set to JPEG basic, image size set to **M** (medium), white balance set to **AUTO**, ISO sensitivity set to ISO 100, shutter speed $1/250$ s, focus cycled from infinity to minimum range three times after shutter-release button has been pressed halfway for 3 s; six shots are then taken in succession and monitor turned on for 4 s and then turned off; cycle repeated once standby timer has expired.
 - 3 Measured at 23 °C/73.4 °F (± 2 °C/3.6 °F) with the camera at default settings and an AF-S DX NIKKOR 18–55mm f/3.5–5.6G VR II lens under conditions specified by the Camera and Imaging Products Association (CIPA). Individual movies can be up to 20 minutes in length or 4 GB in size; recording may end before these limits are reached if the camera temperature rises.

The following can reduce battery life:














































- Using the monitor
- Keeping the shutter-release button pressed halfway
- Repeated autofocus operations
- Taking NEF (RAW) photographs
- Slow shutter speeds
- Using the built-in Wi-Fi or location data functions, or using an optional location data unit
- Using an Eye-Fi card
- Using VR (vibration reduction) mode with VR lenses
- Repeatedly zooming in and out with an AF-P lens.













To ensure that you get the most from rechargeable Nikon EN-EL14a batteries:

- Keep the battery contacts clean. Soiled contacts can reduce battery performance.
- Use batteries immediately after charging. Batteries will lose their charge if left unused.

Index

Symbols

 (Auto mode) 3, 19
 (Auto (flash off) mode) 3, 19
 (Portrait) 3, 31
 (Landscape)..... 3, 31
 (Child)..... 3, 31
 (Sports) 3, 32
 (Close up) 3, 32
SCENE (Scene)..... 3, 33
 (Night portrait).....33
 (Night landscape)33
 (Party/indoor).....34
 (Beach/snow).....34
 (Sunset).....34
 (Dusk/dawn)35
 (Pet portrait)35
 (Candlelight).....35
 (Blossom).....36
 (Autumn colors).....36
 (Food)36
EFFECTS (Special effects) 3, 37
 (Night vision) 3, 37
 (Color sketch) 3, 38, 41
 (Toy camera effect) 3, 38, 42
 (Miniature effect) 3, 38, 42
 (Selective color) 3, 39, 43
 (Silhouette)..... 3, 39
 (High key)..... 3, 39
 (Low key)..... 3, 40
 (HDR painting)..... 3, 40
P (Programmed auto) 3, 82, 84
S (Shutter-priority auto) 3, 82, 85
A (Aperture-priority auto) 3, 82, 86
M (Manual) 3, 82, 87
 (flexible program)84
 (Single frame)45
 (Continuous L)45, 46
 (Continuous H).....45, 46
 (Self-timer).....45, 49
 (Delayed remote (ML-L3))....45, 70
 (Quick-response remote (ML-L3)) 45, 70
 (Quiet shutter release).....45, 48
 (Single-point AF)53
 (Dynamic-area AF)53
 (Auto-area AF)53
 (3D-tracking).....53, 54
 (Face-priority AF)120, 121
 (Wide-area AF)120, 121
 (Normal-area AF)120, 121
 (Subject-tracking AF) .120, 121
 (Matrix metering).....90
 (Center-weighted metering)..90

 (Spot metering) 90
AUTO (auto flash) 63
 (red-eye reduction).....63, 65
SLOW (slow sync).....63, 65
REAR (rear-curtain sync)..... 65
 (Flash compensation) 93
 (Exposure compensation)..... 92
AE-BKT (AE bracketing) 108
WB-BKT (WB bracketing) 108
 (ADL bracketing) 108
 (Help).....8
WB (White balance) 101
PRE (Preset manual)..... 104
 ("Beep" indicator) 187
 (focus indicator)21, 55, 57, 91
 (flash-ready indicator).4, 23, 235
 (live view)24, 27, 118, 126
 i button7, 135
 (Memory buffer) 47, 281

Numerics

2016-pixel RGB sensor.....192, 227, 260, 261
3D color matrix metering.....227
3D-tracking (AF-area mode) 53, 54

A

A/V cable 164
AC adapter236, 239
Access lamp 21
Accessories 236
Accessory terminal accessories..... 237
Active D-Lighting 94
Add items (My Menu)223
ADL bracketing (Auto bracketing set)..... 108
Adobe RGB 179
AE bracketing (Auto bracketing set)..... 108
AE lock..... 91
AE-L 91
AE-L/AF-L button 56, 91, 194
AF 51–56, 119–121
AF area brackets 16, 20
AF-A 51
AF-area mode.....53, 120
AF-assist..... 185
AF-assist illuminator 52, 229
AF-C 51, 184
AF-F 119
AF-S 51, 119
A-GPS data..... 80
A-M mode switch57, 271, 275
Angle of view231

Aperture83, 86, 87
Aperture-priority auto 86
Assign AE-L/AF-L button 194
Assign Fn button 193
Auto (White balance)..... 101
Auto bracketing..... 108, 192
Auto distortion control 179
Auto flash..... 63
Auto image rotation.....202
Auto info display 199
Auto ISO sensitivity control..... 181
Auto off timers 186
Auto-area AF (AF-area mode) ... 53
Autoexposure lock 91
Autofocus.....51–56, 119–121
Auto-servo AF 51
Available settings.....248

B

Battery 11, 236, 264
Beep 187
Black-and-white.....208
Blue intensifier (Filter effects) ..209
Body cap..... 1, 237
Border (PictBridge) 157
Bracketing 108, 192
Built-in AF-assist illuminator 52, 185, 229
Built-in flash 62, 230
Bulb 88
Burst 46, 99

C

Calendar playback 141
Camera Control Pro 2 236
Capture NX 2.....236
CEC 166
Center-weighted metering..... 90
Charger 11, 236, 264
Chose start/end point..... 131
Clean image sensor 241
Clock 15, 201
Clock battery 18
Cloudy (White balance) 101
CLS 232
Color balance..... 210
Color outline 216
Color sketch 41, 216
Color space..... 179
Color temperature 102
Compatible lenses226
Conformity marking.....204, 265
Continuous (Release mode) 45, 46
Continuous-servo AF 51, 184
CPU contacts 227

CPU lens.....	226
Create log.....	76
Creative Lighting System.....	232
Cross screen (Filter effects).....	209
Custom Settings.....	182
Cyanotype.....	208
D	
Date and time.....	15, 201
Date counter.....	190
Date format.....	15, 201
Daylight saving time.....	15, 201
DCF version 2.0.....	265
Delayed remote (ML-L3).....	45, 70
Delete.....	146
Delete all images.....	147
Delete current image.....	146
Delete log.....	78
Delete selected images.....	147
Device control (HDMI).....	166
Digital Print Order Format.....	159, 162, 265
Dioptr adjustment control.....	16, 236
Direct sunlight (White balance).....	101
Distortion control.....	215
D-Lighting.....	207
DPOF.....	159, 162, 265
DPOF print order.....	162
Dynamic-area AF.....	53
E	
Edit movie.....	131, 134
Electronic rangefinder.....	57, 185
EV steps for exposure cntrl.....	186
Exif version 2.3.....	265
Exposure.....	83, 90, 91, 92
Exposure bracketing.....	108
Exposure compensation.....	92
Exposure delay mode.....	189
Exposure indicator.....	87, 122
Exposure lock.....	91
Exposure meters.....	23
Exposure mode.....	82
External microphone.....	129, 237
Eye-Fi upload.....	204
F	
Face-priority AF.....	120
File information.....	136
File number sequence.....	188
Filter effects.....	113, 114, 209
Filters.....	236
Fine-tuning white balance.....	103
Firmware version.....	204
Fisheye.....	216
Flash.....	23, 62, 232
Flash (White balance).....	101
Flash cntrl for built-in flash.....	192
Flash compensation.....	93
Flash control.....	192
Flash mode.....	63, 65
Flash range.....	66
Flash ready indicator.....	4, 23, 235
Flash sync speed.....	66, 260
Flexible program.....	84
Flicker reduction.....	127, 200
Fluorescent (White balance).....	101, 102
Fn button.....	193
f-number.....	83, 86
Focal length.....	231
Focal length scale.....	266, 271, 275
Focal plane mark.....	58
Focus.....	51–58, 119–121, 125
Focus indicator.....	21, 55, 57, 91
Focus lock.....	55
Focus mode.....	51, 119
Focus point.....	21, 53, 55, 57, 120, 121, 184
Focusing screen.....	259
Focusing the viewfinder.....	16
Focus-mode switch.....	18, 57
Format.....	196
Format memory card.....	17, 196
Frame interval (Slide show).....	150
Frame size/frame rate.....	128
Framing grid.....	123, 188
Front-curtain sync.....	65
Full-frame playback.....	135
Full-time-servo AF.....	119
G	
GPS options.....	79
Green intensifier (Filter effects).....	209
H	
H.264.....	262
HDMI.....	165, 265
HDMI-CEC.....	166
HDR (high dynamic range).....	96
Help.....	8
Hi (Sensitivity).....	67
High definition.....	165, 265
High Dynamic Range (HDR).....	96
High ISO NR.....	180
High-angle shots.....	5
Highlights.....	136, 176
Histogram.....	137, 176, 210
I	
Image comment.....	202
Image Dust Off ref photo.....	199
Image overlay.....	211
Image quality.....	59
Image review.....	176
Image size.....	61
Incandescent (White balance).....	101
Info display format.....	197
In-focus indicator.....	21, 55, 57, 91
Information display.....	6, 197
Infrared receiver.....	70
Interval timer shooting.....	68
ISO display.....	188
ISO sensitivity.....	67, 180
i-TTL.....	192
i-TTL balanced fill-flash for digital SLR.....	192
J	
JPEG.....	59
JPEG basic.....	59
JPEG fine.....	59
JPEG normal.....	59
L	
Landscape (Set Picture Control).....	111
Language.....	15, 201
Large (Image size).....	61
Lens.....	13, 226, 266, 271, 275
Lens focus ring.....	57, 266, 271, 275
Lens mount.....	1, 58
Lens vibration reduction switch.....	18, 271, 272, 275, 276
Live view.....	24, 27, 118, 126
Location data.....	xv, 74, 139, 237
Location data unit.....	81, 237
Lock mirror up for cleaning.....	243
Log list.....	78
Long exposure NR.....	179
Low-angle shots.....	5
M	
Manage Picture Control.....	115
Manual.....	57, 87
Manual focus.....	57, 119, 125
Manual movie settings.....	129
Matrix metering.....	90
Maximum aperture.....	57, 226
Maximum sensitivity.....	180
Medium (Image size).....	61
Memory buffer.....	47
Memory card.....	12, 196, 238, 281
Memory card capacity.....	281
Metering.....	90
Microphone.....	128
Miniature effect.....	42, 218
Minimum shutter speed.....	180

Mirror.....	1, 243
Mode dial.....	3
Monitor.....	5, 118, 135, 196
Monitor brightness.....	196
Monochrome.....	208
Monochrome (Set Picture Control) 111.....	
Mounting mark... 13, 266, 271, 275	
MOV.....	189
Movie quality.....	128
Movie settings.....	128
Movie-record button.....	28, 126
Movies.....	27, 126
Multiple exposure.....	98
My Menu.....	223
N	
NEF (RAW).....	59, 178, 213
NEF (RAW) processing.....	213
NEF (RAW) recording.....	178
Network connection.....	169
Neutral (Set Picture Control)....	111
Nikon Transfer 2.....	153
Non-CPU lens.....	228
Normal-area AF.....	120
Number of focus points.....	184
Number of shots.....	282
O	
Optional flash.....	192, 232
Output resolution (HDMI).....	166
Overview data.....	139
P	
Page size (PictBridge).....	157
Perspective control.....	217
Photo information.....	136, 176
PictBridge.....	156, 265
Picture Controls.....	111, 112
PIN-entry WPS.....	170
Playback.....	135
Playback display options.....	176
Playback folder.....	175
Playback information.....	136, 176
Playback menu.....	175
Playback zoom.....	142
Portrait (Set Picture Control)....	111
Power connector.....	236, 239
Power switch.....	2
Preset manual (White balance).....	101, 104
Press the shutter-release button all the way down.....	21
Press the shutter-release button halfway.....	21
Print (DPOF).....	159, 163
Print date.....	190
Print select.....	159
Printing.....	156
Programmed auto.....	84
Protecting photographs.....	143
Push-button WPS.....	169
Q	
Quick retouch.....	215
Quick-response remote (ML-L3)45, 70.....	
Quiet shutter release.....	45, 48
R	
Rangefinder.....	185
Rank items (My Menu).....	225
Rating.....	144, 150
Rear-curtain sync.....	65
Recent settings.....	222
Record location data.....	74
Red intensifier (Filter effects) ...	209
Red-eye correction.....	207
Red-eye reduction.....	63, 65
Release mode.....	45
Remote control.....	70, 237
Remote cord.....	88, 203, 237
Remote on duration (ML-L3)....	187
Remote shutter release.....	203
Remove items (My Menu).....	224
Reset.....	72, 177, 183
Reset custom settings.....	183
Reset shooting menu.....	177
Resize.....	214
Retouch menu.....	205
Retractable lens barrel button . 14, 18.....	
Reverse dial rotation.....	194
Reverse indicators.....	194
RGB.....	137, 179
RGB Histogram.....	137
Rotate tall.....	176
S	
Save selected frame.....	134
Scene auto selector.....	25
Scene mode.....	30
Select to send to smart device	173
Selective color.....	43, 219
Self-portrait.....	5
Self-timer.....	45, 49, 187
Sensitivity.....	67, 180
Sepia.....	208
Set clock from satellite.....	79
Set Picture Control.....	112
Setup menu.....	195
Shade (White balance).....	101
Shooting data.....	138
Shooting menu.....	177
Shutter-priority auto.....	85
Shutter-release button...21, 55, 91, 186.....	
Shutter-release button AE-L....	186
Side-by-side comparison.....	221
Single frame (Release mode).....	45
Single-point AF (AF-area mode)53	
Single-servo AF.....	51, 119
Size.....	61, 128
Skylight (Filter effects).....	209
Slide show.....	149
Slot empty release lock.....	194
Slow sync.....	63, 65
Small (Image size).....	61
Soft (Filter effects).....	209
Special effects mode.....	37
Speedlight.....	232
Spot metering.....	90
sRGB.....	179
SSID.....	171
Standard (Set Picture Control).111	
Standard i-TTL fill-flash for digital SLR.....	192
Standby timer.....	23, 186
Start printing (PictBridge) 158, 161	
Storage folder.....	178
Straighten.....	215
Subject-tracking AF.....	120
T	
Television.....	164
Thumbnail playback.....	140
Time.....	88
Time stamp (PictBridge).....	157
Time zone.....	15, 201
Time zone and date.....	201
Timer.....	49, 68
Toning.....	113, 114
Trim.....	208
Trimming movies.....	131
Type D lens.....	227
Type E lens.....	227
Type G lens.....	227
U	
Update A-GPS data.....	80
USB cable.....	153, 156
UTC.....	74, 139
V	
Vibration reduction... 18, 268, 272, 276.....	
Video mode.....	164, 202
View SSID.....	171
Viewfinder.....	4, 16, 259
Viewfinder eyepiece cap.....	50
Viewfinder grid display.....	188

ViewNX 2.....	151, 153
Vivid (Set Picture Control).....	111
Volume.....	130, 149

W

Warm filter (Filter effects).....	209
WB.....	101
WB bracketing (Auto bracketing set).....	108
White balance.....	101
Wide-area AF	120
Wi-Fi	xvi, 167
Wind noise reduction	128
Wireless.....	xvi, 167
Wireless Mobile Utility.....	167, 168
Wireless remote controller	71, 203, 237

No reproduction in any form of this manual, in whole or in part (except for brief quotation in critical articles or reviews), may be made without written authorization from NIKON CORPORATION.