

Nikon

with **WARRANTY**

DIGITAL CAMERA

D7200

User's Manual (with Warranty)



Nikon Manual Viewer 2

Install the Nikon Manual Viewer 2 app on your smartphone or tablet to view Nikon digital camera manuals, anytime, anywhere.

Nikon Manual Viewer 2 can be downloaded free of charge from the App Store and Google Play.

En

D7200

Model Name: N1406

To get the most from your camera, please be sure to read all instructions thoroughly and keep them where they will be read by all who use the product.

The Menu Guide

For more information on menu options and subjects such as how to connect the camera to a printer or television, download the camera *Menu Guide* from the Nikon website as described below. The *Menu Guide* is in pdf format and can be viewed using Adobe Reader or Adobe Acrobat Reader.

- 1** On your computer, launch a web browser and open the Nikon manual download site at <http://nikonimglib.com/manual/>
- 2** Navigate to the page for the desired product and download the manual.

Nikon User Support

Visit the site below to register your camera and keep up-to-date with the latest product information. You will find answers to frequently asked questions (FAQs) and can contact us for technical assistance.

<http://www.europe-nikon.com/support>

For Your Safety

Before using the camera for the first time, read the safety instructions in "For Your Safety" (☐ x–xiii).

Symbols and Conventions

To make it easier to find the information you need, the following symbols and conventions are used:



This icon marks cautions; information that should be read before use to prevent damage to the camera.



This icon marks notes; information that should be read before using the camera.



This icon marks references to other pages in this manual.

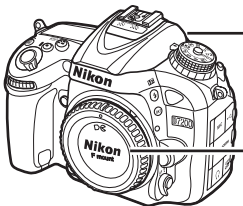
Menu items, options, and messages displayed in the camera monitor are shown in **bold**.

Camera Settings

The explanations in this manual assume that default settings are used.

Package Contents

Be sure all items listed here were included with your camera.



- DK-23 rubber eyecup
(☞ 70)



- BF-1B body cap
(☞ 23, 319)

- D7200 camera (☞ 1)

- EN-EL15 rechargeable Li-ion battery with terminal cover (☞ 21, 22)
- MH-25a battery charger (comes with either an AC wall adapter or power cable of a type and shape that varies with the country or region of sale; ☞ 21)
- DK-5 eyepiece cap (☞ 70)
- UC-E17 USB cable
- AN-DC1 BK strap (☞ 20)
- Warranty (printed on the back cover of this manual)
- User's Manual (this guide)

Memory cards are sold separately. Cameras purchased in Japan display menus and messages in English and Japanese only; other languages are not supported. We apologize for any inconvenience this may cause.

ViewNX-i and Capture NX-D Software

Use ViewNX-i to copy photos and movies to a computer for viewing. ViewNX-i is available for download from the following website:
<http://nikonimglib.com/nvnxi/>

Use Capture NX-D to fine-tune pictures that have been copied to a computer and to convert NEF (RAW) images to other formats. Capture NX-D is available for download from:
<http://nikonimglib.com/ncnxd/>

For the latest information on Nikon software, including system requirements, visit the websites listed on page xix.

Table of Contents

Package Contents	ii
For Your Safety	x
Notices.....	xiv
Wireless	xx
Introduction	1
<hr/>	
Getting to Know the Camera	1
The Multi Selector	15
Camera Menus	16
Using Camera Menus	17
First Steps	20
Basic Photography and Playback	30
<hr/>	
“Point-and-Shoot” Photography (AUTO and Modes)	30
Basic Playback.....	39
Deleting Unwanted Photographs	40
Matching Settings to the Subject or Situation (Scene Mode)	41
<hr/>	
Special Effects	44
<hr/>	
Options Available in Live View	46
P, S, A, and M Modes	51
<hr/>	
P: Programmed Auto	52
S: Shutter-Priority Auto	53
A: Aperture-Priority Auto.....	54
M: Manual.....	56
Long Time-Exposures (M Mode Only)	58

User Settings: U1 and U2 Modes	62
Saving User Settings	62
Recalling User Settings.....	64
Resetting User Settings.....	65
Release Mode	66
Choosing a Release Mode	66
Frame Advance Rate	67
Self-Timer Mode (☺)	69
Mirror up Mode (MUP).....	71
Image Recording Options	73
Image Area.....	73
Image Quality and Size.....	77
Image Quality	77
Image Size.....	81
Using Two Memory Cards	82
Focus	83
Autofocus.....	83
Autofocus Mode	83
AF-Area Mode.....	86
Focus Lock	93
Manual Focus	97
ISO Sensitivity	99
Auto ISO Sensitivity Control.....	102

Exposure	105
<hr/>	
Metering	105
Autoexposure Lock.....	107
Exposure Compensation	109
White Balance	111
<hr/>	
Fine-Tuning White Balance	114
Choosing a Color Temperature	117
Preset Manual	120
Viewfinder Photography.....	120
Live View (Spot White Balance)	124
Managing Presets	127
Image Enhancement	130
<hr/>	
Picture Controls	130
Selecting a Picture Control.....	130
Modifying Picture Controls	132
Creating Custom Picture Controls.....	135
Preserving Detail in Highlights and Shadows	139
Active D-Lighting.....	139
High Dynamic Range (HDR)	141
Flash Photography	144
<hr/>	
Using the Built-in Flash	144
Auto Pop-up Modes.....	144
Manual Pop-up Modes	146
Flash Compensation	151
FV Lock	153


Remote Control Photography **156**

Using an Optional ML-L3 Remote Control.....	156
Wireless Remote Controllers	160
WR-1 Wireless Remote Controllers	160
WR-R10/WR-T10 Wireless Remote Controllers.....	160









Recording and Viewing Movies **161**

Recording Movies	161
The Live View Display: Movies.....	165
Maximum Length.....	166
Indices	167
Image Area.....	168
Taking Photos in Movie Mode	169
Time-Lapse Photography	171
Viewing Movies	177
Editing Movies	179
Trimming Movies	179
Saving Selected Frames	183

Other Shooting Options **185**

The  Button (Viewfinder Photography)	185
The <i>i</i> Button	189
The <i>i</i> -Button Menu (Viewfinder Photography)	190
The <i>i</i> -Button Menu (Live View)	191
Two-Button Reset: Restoring Default Settings	194
Bracketing	197
Multiple Exposure	211
Interval Timer Photography	217
Non-CPU Lenses	224
Location Data	227

More on Playback	229
Viewing Pictures	229
Full-Frame Playback.....	229
Thumbnail Playback	231
Calendar Playback.....	232
The i Button.....	233
Photo Information	234
Taking a Closer Look: Playback Zoom	243
Protecting Photographs from Deletion	245
Deleting Photographs	246
Full-Frame, Thumbnail, and Calendar Playback	246
The Playback Menu.....	248
Wi-Fi	250
What Wi-Fi Can Do for You	250
Accessing the Camera	251
Android and iOS: Connecting via SSID	251
Android: Connecting via NFC.....	254
Android: Other Wi-Fi Connection Options	256
Restoring Default Settings	256
Wireless Security	257
Selecting Pictures for Upload	263
Selecting Individual Pictures for Upload.....	263
Selecting Multiple Pictures for Upload	264
Selecting Pictures for Upload via NFC.....	264
Downloading Selected Pictures to the Smart Device	265

 The Playback Menu: <i>Managing Images</i>	266
 The Photo Shooting Menu: <i>Photo Shooting Options</i>	268
 The Movie Shooting Menu: <i>Movie Shooting Options</i>	273
 Custom Settings: <i>Fine-Tuning Camera Settings</i>	276
 The Setup Menu: <i>Camera Setup</i>	289
 The Retouch Menu: <i>Creating Retouched Copies</i>	294
 My Menu/  Recent Settings	297
Retouch Menu Options	298
Trim	298
Image Overlay	299
NEF (RAW) Processing	302

Technical Notes

Compatible Lenses	304
Optional Flash Units (Speedlights)	311
The Nikon Creative Lighting System (CLS).....	311
Other Accessories	319
Caring for the Camera	320
Storage.....	320
Cleaning.....	320
Image Sensor Cleaning	321
Caring for the Camera and Battery: Cautions	328

Troubleshooting	333
Battery/Display	333
Shooting (All Modes)	334
Shooting (P, S, A, M)	337
Playback	338
Wi-Fi (Wireless Networks)	340
Miscellaneous	340
Error Messages	341
Specifications	348
Lenses	363
Approved Memory Cards	379
Memory Card Capacity	380
Battery Life	382
Index	384
Warranty Terms - Nikon Europe Service Warranty	393

For Your Safety

To prevent damage to your Nikon product or injury to yourself or to others, read the following safety precautions in their entirety before using this equipment. Keep these safety instructions where all those who use the product will read them.

The consequences that could result from failure to observe the precautions listed in this section are indicated by the following symbol:



This icon marks warnings. To prevent possible injury, read all warnings before using this Nikon product.

■ ■ WARNINGS

Keep the sun out of the frame

Keep the sun well out of the frame when shooting backlit subjects. Sunlight focused into the camera when the sun is in or close to the frame could cause a fire.

Do not look at the sun through the viewfinder

Viewing the sun or other strong light source through the viewfinder could cause permanent visual impairment.

Using the viewfinder diopter adjustment control

When operating the viewfinder diopter adjustment control with your eye to the viewfinder, care should be taken not to put your finger in your eye accidentally.

Turn off immediately in the event of malfunction

Should you notice smoke or an unusual smell coming from the equipment or AC adapter (available separately), unplug the AC adapter and remove the battery immediately, taking care to avoid burns. Continued operation could result in injury. After removing the battery, take the equipment to a Nikon-authorized service center for inspection.

Do not use in the presence of flammable gas

Do not use electronic equipment in the presence of flammable gas, as this could result in explosion or fire.

Keep out of reach of children

Failure to observe this precaution could result in injury. In addition, note that small parts constitute a choking hazard. Should a child swallow any part of this equipment, consult a physician immediately.

⚠ Do not disassemble

Touching the product's internal parts could result in injury. In the event of malfunction, the product should be repaired only by a qualified technician. Should the product break open as the result of a fall or other accident, remove the battery and/or AC adapter and then take the product to a Nikon-authorized service center for inspection.

⚠ Do not place the strap around the neck of an infant or child

Placing the camera strap around the neck of an infant or child could result in strangulation.

⚠ Do not remain in contact with the camera, battery, or charger for extended periods while the devices are on or in use

Parts of the device become hot. Leaving the device in direct contact with the skin for extended periods may result in low-temperature burns.

⚠ Do not leave the product where it will be exposed to extremely high temperatures, such as in an enclosed automobile or in direct sunlight

Failure to observe this precaution could cause damage or fire.

⚠ Do not aim a flash at the operator of a motor vehicle

Failure to observe this precaution could result in accidents.

⚠ Observe caution when using the flash

- Using the camera with the flash in close contact with the skin or other objects could cause burns.
- Using the flash close to the subject's eyes could cause temporary visual impairment. The flash should be no less than one meter (3 ft 4 in.) from the subject. Particular care should be observed when photographing infants.

⚠ Avoid contact with liquid crystal

Should the monitor break, care should be taken to avoid injury due to broken glass and to prevent the liquid crystal from the monitor touching the skin or entering the eyes or mouth.

⚠ Do not carry tripods with a lens or camera attached

You could trip or accidentally strike others, resulting in injury.

⚠ Observe proper precautions when handling batteries

Batteries may leak or explode if improperly handled. Observe the following precautions when handling batteries for use in this product:

- Use only batteries approved for use in this equipment.
- Do not short or disassemble the battery.
- Be sure the product is off before replacing the battery. If you are using an AC adapter, be sure it is unplugged.
- Do not attempt to insert the battery upside down or backwards.
- Do not expose the battery to flame or to excessive heat.
- Do not immerse in or expose to water.
- Replace the terminal cover when transporting the battery. Do not transport or store the battery with metal objects such as necklaces or hairpins.
- Batteries are prone to leakage when fully discharged. To avoid damage to the product, be sure to remove the battery when no charge remains.

- When the battery is not in use, attach the terminal cover and store in a cool, dry place.
- The battery may be hot immediately after use or when the product has been used on battery power for an extended period. Before removing the battery turn the camera off and allow the battery to cool.
- Discontinue use immediately should you notice any changes in the battery, such as discoloration or deformation.

⚠ Observe proper precautions when handling the charger

- Keep dry. Failure to observe this precaution could result in injury or product malfunction due to fire or electric shock.
- Do not short the charger terminals. Failure to observe this precaution could result in overheating and damage to the charger.
- Dust on or near the metal parts of the plug should be removed with a dry cloth. Continued use could result in fire.

- Do not handle the power cable or go near the charger during thunderstorms. Failure to observe this precaution could result in electric shock.
 - Do not damage, modify, or forcibly tug or bend the power cable. Do not place it under heavy objects or expose it to heat or flame. Should the insulation be damaged and the wires become exposed, take the power cable to a Nikon-authorized service representative for inspection. Failure to observe this precaution could result in fire or electric shock.
 - Do not handle the plug or charger with wet hands. Failure to observe this precaution could result in injury or product malfunction due to fire or electric shock.
 - Do not use with travel converters or adapters designed to convert from one voltage to another or with DC-to-AC inverters. Failure to observe this precaution could damage the product or cause overheating or fire.
- ⚠ Use appropriate cables**
When connecting cables to the input and output jacks, use only the cables provided or sold by Nikon for the purpose to maintain compliance with product regulations.
- ⚠ Follow the instructions of airline and hospital personnel**

Notices

- No part of the manuals included with this product may be reproduced, transmitted, transcribed, stored in a retrieval system, or translated into any language in any form, by any means, without Nikon's prior written permission.
- Nikon reserves the right to change the specifications of the hardware and software described in these manuals at any time and without prior notice.
- Nikon will not be held liable for any damages resulting from the use of this product.
- While every effort has been made to ensure that the information in these manuals is accurate and complete, we would appreciate it were you to bring any errors or omissions to the attention of the Nikon representative in your area (address provided separately).

Notice for Customers in Canada

CAN ICES-3 B / NMB-3 B

Notices for Customers in Europe

CAUTION: RISK OF EXPLOSION IF BATTERY IS REPLACED BY AN INCORRECT TYPE. DISPOSE OF USED BATTERIES ACCORDING TO THE INSTRUCTIONS.

This symbol indicates that electrical and electronic equipment is to be collected separately.



The following apply only to users in European countries:

- This product is designated for separate collection at an appropriate collection point. Do not dispose of as household waste.
- Separate collection and recycling helps conserve natural resources and prevent negative consequences for human health and the environment that might result from incorrect disposal.
- For more information, contact the retailer or the local authorities in charge of waste management.

This symbol on the battery indicates that the battery is to be collected separately.



The following apply only to users in European countries:

- All batteries, whether marked with this symbol or not, are designated for separate collection at an appropriate collection point. Do not dispose of as household waste.
- For more information, contact the retailer or the local authorities in charge of waste management.

Notices for Customers in the U.S.A.

Power Cable

At voltages over AC 125 V (U.S.A. only): The power cable must be rated for the voltage in use, be at least AWG no. 18 gauge, and have SVG insulation or better with a NEMA 6P-15 plug rated for AC 250 V 15 A.

Federal Communications Commission (FCC) Radio Frequency Interference Statement

This equipment has been tested and found to comply with the limits for a Class B digital device, pursuant to Part 15 of the FCC rules. These limits are designed to provide reasonable protection against harmful interference in a residential installation. This equipment generates, uses, and can radiate radio frequency energy and, if not installed and used in accordance with the instructions, may cause harmful interference to radio communications. However, there is no guarantee that interference will not occur in a particular installation. If this equipment does cause harmful interference to radio or television reception, which can be determined by turning the equipment off and on, the user is encouraged to try to correct the interference by one or more of the following measures:

- Reorient or relocate the receiving antenna.
- Increase the separation between the equipment and receiver.
- Connect the equipment into an outlet on a circuit different from that to which the receiver is connected.
- Consult the dealer or an experienced radio/television technician for help.



Nikon
D7200

CAUTIONS

Modifications

The FCC requires the user to be notified that any changes or modifications made to this device that are not expressly approved by Nikon Corporation may void the user's authority to operate the equipment.

Interface Cables

Use the interface cables sold or provided by Nikon for your equipment. Using other interface cables may exceed the limits of Class B Part 15 of the FCC rules.

Nikon Inc., 1300 Walt Whitman Road,
Melville, New York 11747-3064, U.S.A.
Tel.: 631-547-4200

Notice Concerning Prohibition of Copying or Reproduction

Note that simply being in possession of material that has been digitally copied or reproduced by means of a scanner, digital camera, or other device may be punishable by law.

- **Items prohibited by law from being copied or reproduced**

Do not copy or reproduce paper money, coins, securities, government bonds, or local government bonds, even if such copies or reproductions are stamped “Sample.”

The copying or reproduction of paper money, coins, or securities which are circulated in a foreign country is prohibited.

Unless the prior permission of the government has been obtained, the copying or reproduction of unused postage stamps or post cards issued by the government is prohibited.

The copying or reproduction of stamps issued by the government and of certified documents stipulated by law is prohibited.

- **Cautions on certain copies and reproductions**

The government has issued cautions on copies or reproductions of securities issued by private companies (shares, bills, checks, gift certificates, etc.), commuter passes, or coupon tickets, except when a minimum of necessary copies are to be provided for business use by a company. Also, do not copy or reproduce passports issued by the government, licenses issued by public agencies and private groups, ID cards, and tickets, such as passes and meal coupons.

- **Comply with copyright notices**

The copying or reproduction of copyrighted creative works such as books, music, paintings, woodcuts, prints, maps, drawings, movies, and photographs is governed by national and international copyright laws. Do not use this product for the purpose of making illegal copies or to infringe copyright laws.

Disposing of Data Storage Devices

Please note that deleting images or formatting memory cards or other data storage devices does not completely erase the original image data. Deleted files can sometimes be recovered from discarded storage devices using commercially available software, potentially resulting in the malicious use of personal image data. Ensuring the privacy of such data is the user's responsibility.

Before discarding a data storage device or transferring ownership to another person, erase all data using commercial deletion software, or format the device and then completely refill it with images containing no private information (for example, pictures of empty sky). Be sure to also replace any pictures selected for preset manual (□ 127). Before discarding the camera or transferring ownership to another person, you should also use the **Wi-Fi > Network settings > Reset network settings** (□ 256) and **Network > Network settings** options in the camera setup menu to delete any personal network information. For more information on the **Network** menu, see the documentation provided with the optional communication unit. Care should be taken to avoid injury when physically destroying data storage devices.

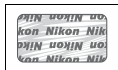
AVC Patent Portfolio License

THIS PRODUCT IS LICENSED UNDER THE AVC PATENT PORTFOLIO LICENSE FOR THE PERSONAL AND NON-COMMERCIAL USE OF A CONSUMER TO (i) ENCODE VIDEO IN COMPLIANCE WITH THE AVC STANDARD ("AVC VIDEO") AND/OR (ii) DECODE AVC VIDEO THAT WAS ENCODED BY A CONSUMER ENGAGED IN A PERSONAL AND NON-COMMERCIAL ACTIVITY AND/OR WAS OBTAINED FROM A VIDEO PROVIDER LICENSED TO PROVIDE AVC VIDEO. NO LICENSE IS GRANTED OR SHALL BE IMPLIED FOR ANY OTHER USE. ADDITIONAL INFORMATION MAY BE OBTAINED FROM MPEG LA, L.L.C. SEE <http://www.mpegla.com>

Use Only Nikon Brand Electronic Accessories

Nikon cameras are designed to the highest standards and include complex electronic circuitry. Only Nikon brand electronic accessories (including chargers, batteries, AC adapters, and flash accessories) certified by Nikon specifically for use with this Nikon digital camera are engineered and proven to operate within the operational and safety requirements of this electronic circuitry.

The use of non-Nikon electronic accessories could damage the camera and may void your Nikon warranty. The use of third-party rechargeable Li-ion batteries not bearing the Nikon holographic seal shown at right could interfere with normal operation of the camera or result in the batteries overheating, igniting, rupturing, or leaking.



For more information about Nikon brand accessories, contact a local authorized Nikon dealer.

✔ Use Only Nikon Brand Accessories

Only Nikon brand accessories certified by Nikon specifically for use with your Nikon digital camera are engineered and proven to operate within its operational and safety requirements. THE USE OF NON-NIKON ACCESSORIES COULD DAMAGE YOUR CAMERA AND MAY VOID YOUR NIKON WARRANTY.

✔ Before Taking Important Pictures

Before taking pictures on important occasions (such as at weddings or before taking the camera on a trip), take a test shot to ensure that the camera is functioning normally. Nikon will not be held liable for damages or lost profits that may result from product malfunction.

✔ Life-Long Learning

As part of Nikon's "Life-Long Learning" commitment to ongoing product support and education, continually-updated information is available on-line at the following sites:

- **For users in the U.S.A.:** <http://www.nikonusa.com/>
- **For users in Europe and Africa:** <http://www.europe-nikon.com/support/>
- **For users in Asia, Oceania, and the Middle East:** <http://www.nikon-asia.com/>

Visit these sites to keep up-to-date with the latest product information, tips, answers to frequently-asked questions (FAQs), and general advice on digital imaging and photography. Additional information may be available from the Nikon representative in your area. See the following URL for contact information: <http://imaging.nikon.com/>

Wireless

This product, which contains encryption software developed in the United States, is controlled by the United States Export Administration Regulations and may not be exported or re-exported to any country to which the United States embargoes goods. The following countries are currently subject to embargo: Cuba, Iran, North Korea, Sudan, and Syria.

The use of wireless devices may be prohibited in some countries or regions. Contact a Nikon-authorized service representative before using the wireless features of this product outside the country of purchase.

Notices for Customers in the U. S. A.

This device complies with Part 15 of FCC Rules and Industry Canada licence-exempt RSS standard(s). Operation is subject to the following two conditions: (1) this device may not cause interference, and (2) this device must accept any interference, including interference that may cause undesired operation of the device.

FCC WARNING

The FCC requires the user to be notified that any changes or modifications made to this device that are not expressly approved by Nikon Corporation may void the user's authority to operate the equipment.

FCC Radio Frequency Interference Statement

Note: This equipment has been tested and found to comply with the limits for a Class B digital device, pursuant to part 15 of the FCC Rules. These limits are designed to provide reasonable protection against harmful interference in a residential installation. This equipment generates, uses and can radiate radio frequency energy and, if not installed and used in accordance with the instructions, may cause harmful interference to radio communications. However, there is no guarantee that interference will not occur in a particular installation. If this equipment does cause harmful interference to radio or television reception, which can be determined by turning the equipment off and on, the user is encouraged to try to correct the interference by one or more of the following measures:

- Reorient or relocate the receiving antenna.
- Increase the separation between the equipment and receiver.
- Connect the equipment into an outlet on a circuit different from that to which the receiver is connected.
- Consult the dealer or an experienced radio/TV technician for help.

Co-location

This transmitter must not be co-located or operated in conjunction with any other antenna or transmitter.

Nikon Inc., 1300 Walt Whitman Road, Melville, New York 11747-3064, U.S.A.
Tel.: 631-547-4200

Notices for Customers in Canada

This device complies with Part 15 of FCC Rules and Industry Canada licence-exempt RSS standard(s). Operation is subject to the following two conditions: (1) this device may not cause interference, and (2) this device must accept any interference, including interference that may cause undesired operation of the device.

FCC/IC RF Exposure Statement

The available scientific evidence does not show that any health problems are associated with using low power wireless devices. There is no proof, however, that these low power wireless devices are absolutely safe. Low power Wireless devices emit low levels of radio frequency energy (RF) in the microwave range while being used. Whereas high levels of RF can produce health effects (by heating tissue), exposure of low-level RF that does not produce heating effects causes no known adverse health effects. Many studies of low-level RF exposures have not found any biological effects. Some studies have suggested that some biological effects might occur, but such findings have not been confirmed by additional research. The D7200, which is equipped with a LBWA1U5YR1 (FCC ID: VPYLBYR650 / IC ID: 772C-LBYR650) wireless LAN module, has been tested and found to comply with FCC/IC radiation exposure limits set forth for an uncontrolled environment and meets the FCC radio frequency (RF) Exposure Guidelines in Supplement C to OET65 and RSS-102 of the IC radio frequency (RF) Exposure rules. Please refer to the SAR test report that was uploaded to FCC website.

Notices for Customers in Europe

Hereby, Nikon Corporation, declares that the D7200 is in compliance with the essential requirements and other relevant provisions of Directive 1999/5/EC. The declaration of conformity may be consulted at http://imaging.nikon.com/support/pdf/DoC_D7200.pdf



Notice for Customers in Singapore

Trade Name: **Nikon**
Model: D7200

This device complies with radio-frequency regulations. The content of certification labels not affixed to the device is given below.

Complies with
IMDA Standards
DA103423

Security

Although one of the benefits of this product is that it allows others to freely connect for the wireless exchange of data anywhere within its range, the following may occur if security is not enabled:

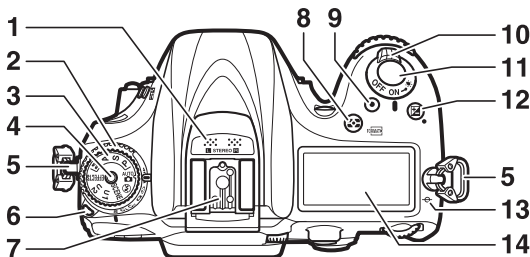
- Data theft: Malicious third-parties may intercept wireless transmissions to steal user IDs, passwords, and other personal information.
- Unauthorized access: Unauthorized users may gain access to the network and alter data or perform other malicious actions. Note that due to the design of wireless networks, specialized attacks may allow unauthorized access even when security is enabled.

Introduction

Getting to Know the Camera

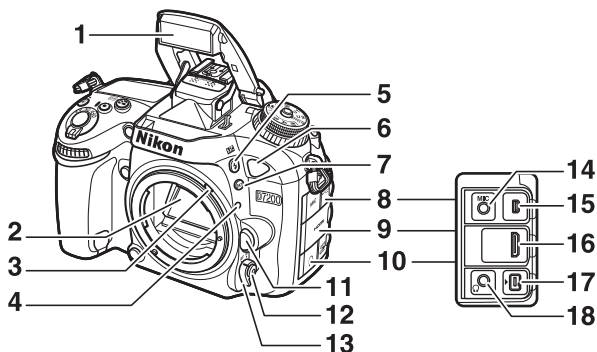
Take a few moments to familiarize yourself with camera controls and displays. You may find it helpful to bookmark this section and refer to it as you read through the rest of the manual.

The Camera Body



1 Stereo microphone... 163, 192, 273	8 button..... 106, 289
2 Release mode dial 8, 66	9 Movie-record button 163
3 Mode dial 6	10 Power switch 5, 24
4 Mode dial lock release 6	11 Shutter-release button 34, 35
5 Eyelet for camera strap 20	12 button 109, 194
6 Release mode dial lock release 8, 66	13 Focal plane mark (\ominus) 98
7 Accessory shoe (for optional flash unit) 311, 319	14 Control panel 9

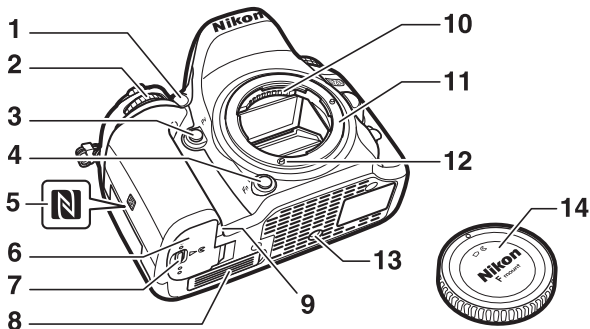
The Camera Body (Continued)



1 Built-in flash.....	36, 144	10 Cover for accessory terminal and headphone connector	160, 193, 227
2 Mirror.....	71, 324	11 Lens release button	29
3 Meter coupling lever	352	12 AF-mode button.....	84, 90
4 Lens mounting mark	23	13 Focus-mode selector	83, 97
5 button	144, 146, 151	14 Connector for external microphone	193, 319
6 Infrared receiver (front).....	157	15 USB connector	
7 BKT button.....	198, 203, 207	16 HDMI connector	319
8 Cover for USB and external microphone connectors	193, 319	17 Accessory terminal.....	160, 227
9 HDMI connector cover	319	18 Headphone connector.....	193

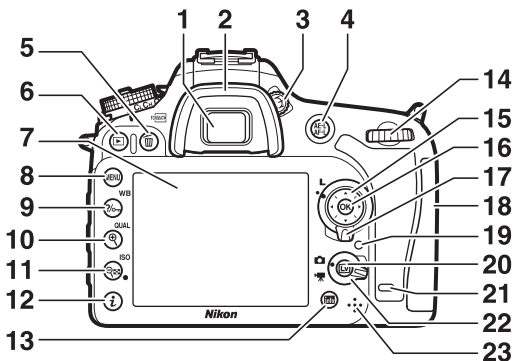
Close the Connector Cover

Close the connector cover when the connectors are not in use. Foreign matter in the connectors can interfere with data transfer.





<p>1 AF-assist illuminator 34, 277 Self-timer lamp..... 69 Red-eye reduction lamp 145, 147</p>	<p>7 Battery-chamber cover latch22, 28</p>
<p>2 Sub-command dial.....285</p>	<p>8 Contact cover for optional MB-D15 battery pack..... 319</p>
<p>3 Pv button 55, 167, 285, 288</p>	<p>9 Power connector cover</p>
<p>4 Fn button..... 76, 284, 288</p>	<p>10 CPU contacts</p>
<p>5 N-Mark (NFC antenna).....254</p>	<p>11 Lens mount23, 98</p>
<p>6 Battery-chamber cover22, 28</p>	<p>12 AF coupling</p>
	<p>13 Tripod socket</p>
	<p>14 Body cap ii, 23, 319</p>

The Camera Body (Continued)



1 Viewfinder eyepiece 10, 25	13 info (info) button 13, 185
2 Rubber eyecup 70	14 Main command dial 285
3 Diopter adjustment control 25	15 Multi selector 15, 17
4 AF-ON button 94, 107, 285, 288	16 OK (OK) button 15, 17, 284
5 Playback button 40, 246, 289	17 Focus selector lock 89
6 Monitor 31, 39, 161, 185, 229	18 Memory card slot cover 22, 28
7 MENU button 16, 266	19 Memory card access lamp 35, 220
8 WB button 17, 112, 115, 119, 121, 245	20 Lv button 12, 31, 161
9 QUAL button 38, 78, 81, 243	21 Infrared receiver (rear) 157
10 ISO button 100, 104, 194, 231, 232	22 Live view selector 12, 31, 161
11 i button 189, 233	23 Speaker 5, 178

LCD Illuminators

Rotating the power switch toward  activates the standby timer and control panel backlight (LCD illuminator), allowing the display to be read in the dark. After the power switch is released, the illuminators will remain lit for a few seconds while the standby timer is active or until the shutter is released or the power switch is rotated toward  again.



*Power
switch*

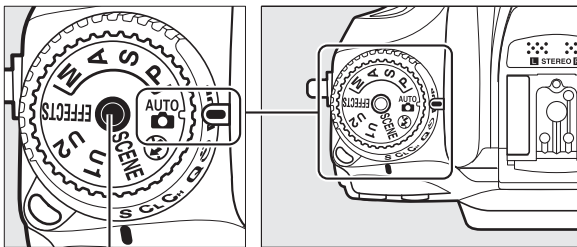
The Speaker

Do not place the speaker in close proximity to magnetic devices. Failure to observe this precaution could affect the data recorded on the magnetic devices.

The Mode Dial

The camera offers the modes listed below. To choose a mode, press the mode dial lock release and rotate the mode dial.

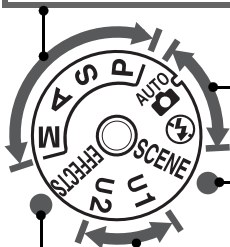
Mode dial



Mode dial lock release

P, S, A, and M modes:

- **P**— Programmed auto (□ 52)
- **S**— Shutter-priority auto (□ 53)
- **A**— Aperture-priority auto (□ 54)
- **M**— Manual (□ 56)



Auto modes:

- **AUTO** Auto (□ 30)
- **Auto (flash off)** (□ 30)

Scene modes (□ 41)

U1 and U2 modes (□ 62)

Special effects modes (□ 44)

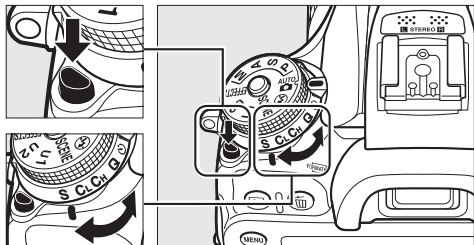
Non-CPU Lenses

Non-CPU (📖 305) lenses can be used only in modes **A** and **M**. Selecting another mode when a non-CPU lens is attached disables the shutter release.

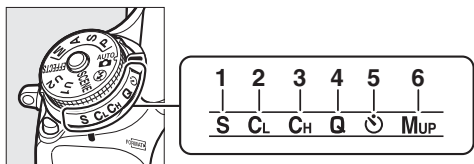
The Release-Mode Dial

To choose a release mode, press the release mode dial lock release and turn the release mode dial to the desired setting (66).

Release mode dial lock release



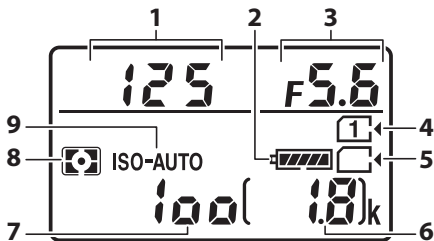
Release mode dial



- | | | | | | |
|---|--------------------------------------|----|---|-------------------------------------|--------|
| 1 | S Single frame..... | 66 | 4 | Q Quiet shutter-release..... | 66 |
| 2 | CL Continuous low speed..... | 66 | 5 | (timer icon) Self-timer..... | 66, 69 |
| 3 | CH Continuous high speed..... | 66 | 6 | MUP Mirror up..... | 66, 71 |

The Control Panel

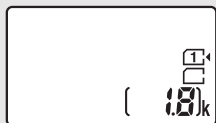
The control panel shows a variety of camera settings when the camera is on. The items shown here appear the first time the camera is turned on; information on other settings can be found in the relevant sections of this manual.



1 Shutter speed53, 56	6 Number of exposures remaining..... 27
2 Battery indicator 26	7 ISO sensitivity 99
3 Aperture (f-number)54, 56	8 Metering 105
4 Memory card indicator (Slot 1).....27, 82	9 ISO sensitivity indicator 99
5 Memory card indicator (Slot 2).....27, 82	Auto ISO sensitivity indicator 103

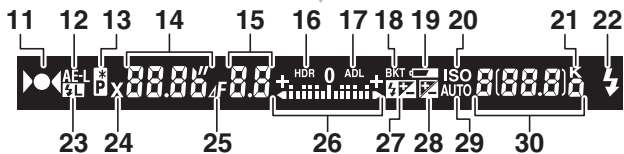
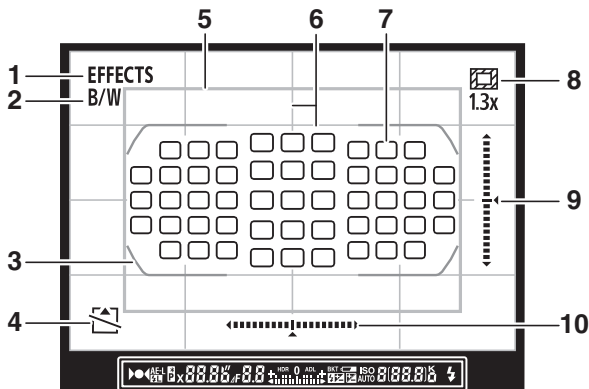
Camera Off Display

If the camera is turned off with a battery and memory card inserted, the memory card icon and number of exposures remaining will be displayed (some memory cards may in rare cases only display this information when the camera is on).





Control panel

The Viewfinder



- | | |
|--|---|
| <p>1 Special effects mode indicator44</p> <p>2 Monochrome indicator44, 130</p> <p>3 AF area brackets.....25, 33</p> <p>4 “No memory card” indicator29</p> <p>5 1.3× DX crop73, 74</p> <p>6 Framing grid (displayed when On is selected for Custom Setting d7, Viewfinder grid display) ... 280</p> | <p>7 Focus points..... 34, 89, 277</p> <p>8 1.3× DX crop indicator 73, 74</p> <p>9 Roll indicator (portrait orientation)*</p> <p>10 Roll indicator (landscape orientation)*</p> <p>11 Focus indicator..... 34, 93, 98</p> <p>12 Autoexposure (AE) lock..... 107</p> <p>13 Flexible program indicator.....52</p> |
|--|---|

14	Shutter speed	53, 56	24	Flash sync indicator	282
15	Aperture (f-number)	54, 56	25	Aperture stop indicator	54, 308
	Aperture (number of stops)	54, 308	26	Exposure indicator	57
16	HDR indicator	142		Exposure compensation display	109
17	ADL indicator	140	27	Flash compensation indicator	151
18	Exposure/flash bracketing indicator	198	28	Exposure compensation indicator	110
	WB bracketing indicator	203	29	Auto ISO sensitivity indicator	103
	ADL bracketing indicator	207	30	Number of exposures remaining	27
19	Low battery warning	26		Number of shots remaining before memory buffer fills	68, 380
20	ISO sensitivity indicator	100		Preset manual white balance recording indicator	122
21	"k" (appears when memory remains for over 1000 exposures)	27			
22	Flash-ready indicator	36, 280			
23	FV lock indicator	154			

* When **Viewfinder virtual horizon** is selected for Custom Setting f2 (**Assign Fn button**, ) or f3 (**Assign preview button**, ) > **Press**, the selected button can be used to display a roll indicator in the viewfinder.

Note: Display shown with all indicators lit for illustrative purposes.




No Battery

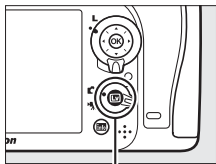
When the battery is totally exhausted or no battery is inserted, the display in the viewfinder will dim. This is normal and does not indicate a malfunction. The viewfinder display will return to normal when a fully-charged battery is inserted.

The Control Panel and Viewfinder Displays

The brightness of the control panel and viewfinder displays varies with temperature, and the response times of the displays may drop at low temperatures. This is normal and does not indicate a malfunction.


The Monitor (Live View)

To frame photos or movies in the monitor, rotate the live view selector to  (photo live view) or  (movie live view) and press the  button.




 button




Live view selector rotated to 



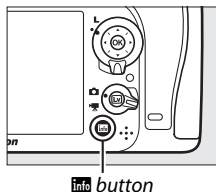
Live view selector rotated to 

The Count Down Display

A count down will be displayed 30 s before live view ends automatically (the timer turns red if live view is about to end to protect the internal circuits or, if an option other than **No limit** is selected for Custom Setting c4—**Monitor off delay** > **Live view**;  279—5 s before the monitor is due to turn off automatically). Depending on shooting conditions, the timer may appear immediately when live view is selected. Movie recording will end automatically when the timer expires, regardless of the amount of recording time available.

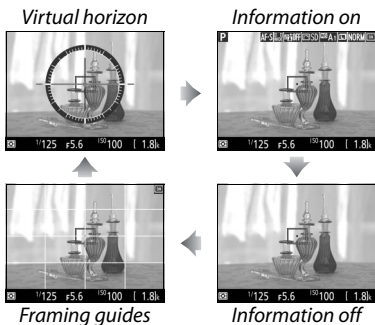
■ Viewing and Hiding Indicators

Press the **info** button to hide or display indicators in the monitor.



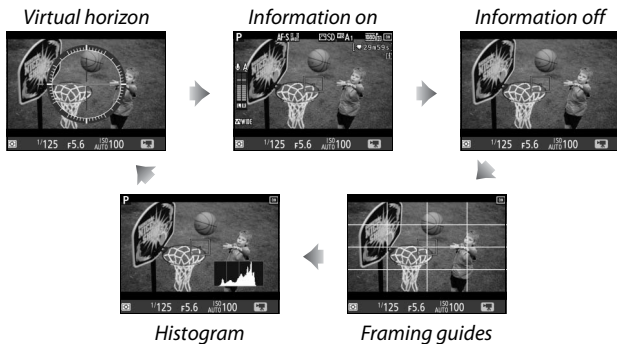
📷 Mode

If the live view selector is rotated to 📷 (photo live view), pressing the **info** button cycles through the following displays.







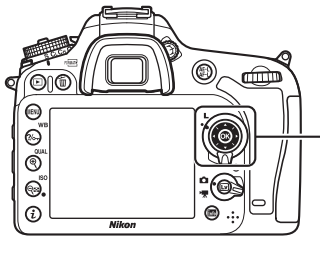
Mode


If the live view selector is rotated to **Movie live view**, pressing the **Info** button cycles through the following displays.

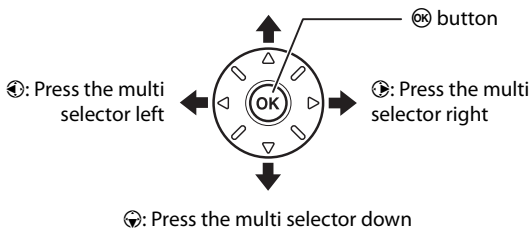


The Multi Selector

In this manual, operations using the multi selector are represented by , , , and  icons.

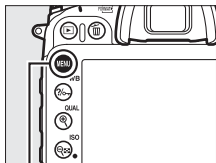


: Press the multi selector up



Camera Menu

Most shooting, playback, and setup options can be accessed from the camera menu. To view the menus, press the **MENU** button.

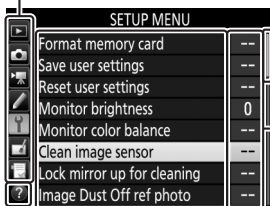


MENU button

Tabs

Choose from the following menus:

- : **Playback** (□ 266)
- : **Photo Shooting** (□ 268)
- : **Movie Shooting** (□ 273)
- : **Custom Settings** (□ 276)
- : **Setup** (□ 289)
- : **Retouch** (□ 294)
- : **MY MENU** or **RECENT SETTINGS** (defaults to **MY MENU**; □ 297)



Slider shows position in current menu.

Current settings are shown by icons.

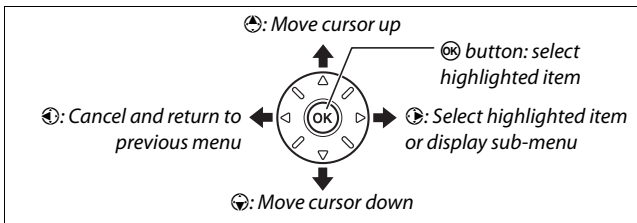
Menu options
Options in current menu.

Help icon (□ 17)

Using Camera Menus

■ Menu Controls

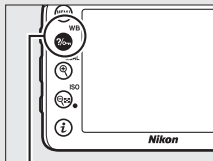
The multi selector and **OK** button are used to navigate the camera menus.



■ The **?** (Help) Icon

If a **?** icon is displayed at the bottom left corner of the monitor, help can be displayed by pressing the **?** (WB) button.

A description of the currently selected option or menu will be displayed while the button is pressed. Press **▲** or **▼** to scroll through the display.



? (WB) button

? Multiple exposure

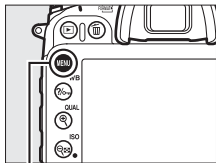
Record the specified number of shots as a single image. The standby timer is extended by 30 s. If the timer expires, shooting will end and a multiple exposure will be created from any shots that have been taken.

■ Navigating the Menus

Follow the steps below to navigate the menus.


1 Display the menus.

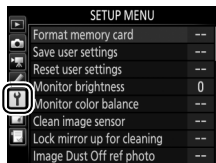
Press the **MENU** button to display the menus.



MENU button

2 Highlight the icon for the current menu.

Press  to highlight the icon for the current menu.




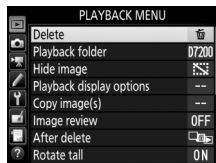
3 Select a menu.

Press  or  to select the desired menu.





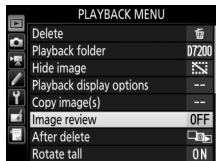
4 Position the cursor in the selected menu.

Press  to position the cursor in the selected menu.




5 Highlight a menu item.

Press  or  to highlight a menu item.





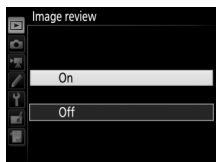
6 Display options.

Press  to display options for the selected menu item.




7 Highlight an option.

Press  or  to highlight an option.






8 Select the highlighted item.

Press  to select the highlighted item. To exit without making a selection, press the **MENU** button.



Note the following:

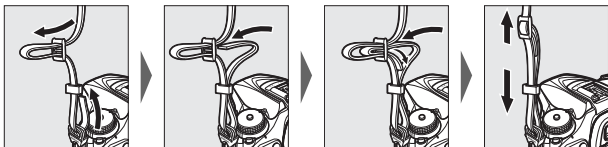
- Menu items that are displayed in gray are not currently available.
- While pressing  generally has the same effect as pressing , there are some cases in which selection can only be made by pressing .
- To exit the menus and return to shooting mode, press the shutter-release button halfway.

First Steps

Follow the seven steps below to ready the camera for use.

1 Attach the strap.

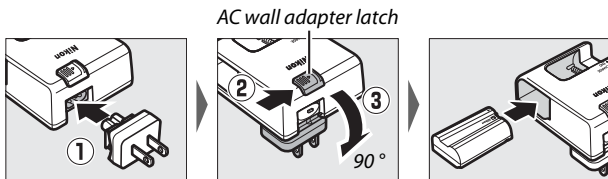
Attach the strap as shown. Repeat for the second eyelet.



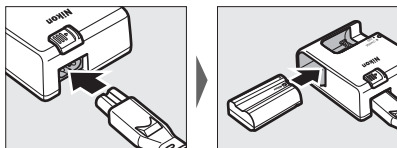
2 Charge the battery.

Insert the battery and plug the charger in (depending on the country or region, the charger comes with either an AC wall adapter or a power cable). An exhausted battery will fully charge in about two hours and 35 minutes.

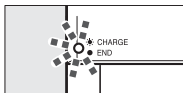
- **AC wall adapter:** Insert the AC wall adapter into the charger AC inlet (①). Slide the AC wall adapter latch as shown (②) and rotate the adapter 90° to fix it in place (③). Insert the battery and plug the charger in.



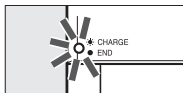
- **Power cable:** After connecting the power cable with the plug in the orientation shown, insert the battery and plug the cable in.



The **CHARGE** lamp will flash while the battery charges.



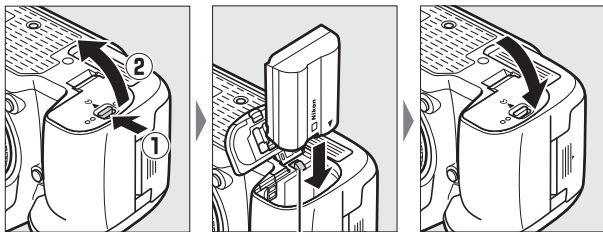
Battery charging



Charging complete

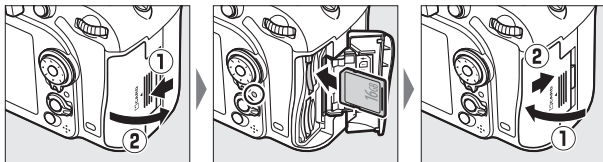
3 Insert the battery and memory card.

Before inserting or removing the battery or memory cards, confirm that power switch is in the **OFF** position. Insert the battery in the orientation shown, using the battery to keep the orange battery latch pressed to one side. The latch locks the battery in place when the battery is fully inserted.



Battery latch

If you are using only one memory card, insert it into slot 1 (□ 27). Slide the memory card in until it clicks into place.

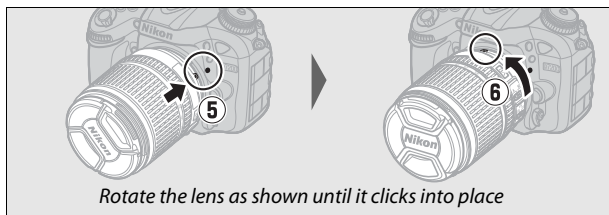
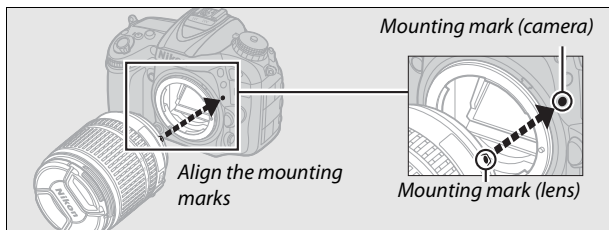
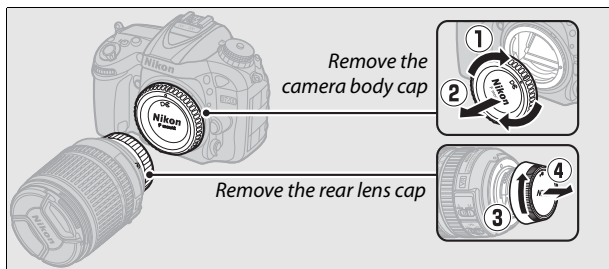


The Battery and Charger

Read and follow the warnings and cautions on pages x–xiii and 330–332 of this manual.

4 Attach a lens.

Be careful to prevent dust from entering the camera when the lens or body cap is removed. The lens generally used in this manual for illustrative purposes is an AF-S DX NIKKOR 18–105mm f/3.5–5.6G ED VR.

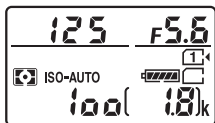
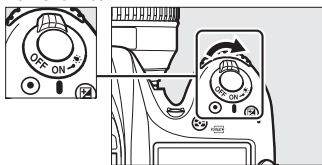


Be sure to remove the lens cap before taking pictures.

5 Turn the camera on.

The control panel will light. If this is the first time the camera has been turned on, a language-selection dialog will be displayed.

Power switch




Control panel

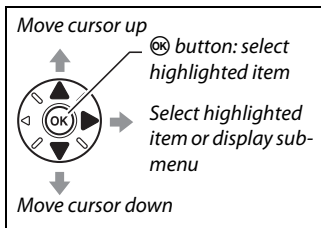
Image Sensor Cleaning

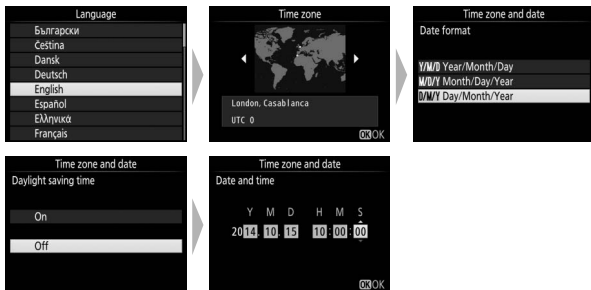
The camera vibrates the image sensor to remove dust when the camera is turned on or off (☐ 321).

6 Choose a language and set the camera clock.

Use the multi selector and  button to select a language and set the camera clock. When setting the camera clock, you will be prompted to choose a time zone, date

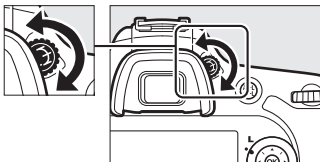
format, and daylight saving time option before setting the time and date; note that the camera uses a 24-hour clock. Language and date/time settings can be changed at any time using the **Language** (☐ 290) and **Time zone and date** (☐ 290) options in the setup menu.





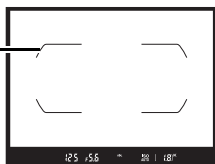
7 Focus the viewfinder.

Rotate the diopter adjustment control until the AF area brackets are in sharp focus. When operating the control with your eye to the viewfinder, be careful not to put your fingers or fingernails in your eye.



Viewfinder not in focus

AF area brackets

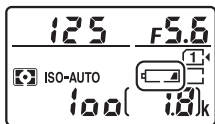


Viewfinder in focus

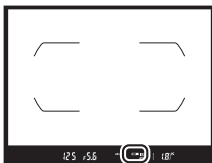
The camera is now ready for use. Proceed to page 30 for information on taking photographs.

■ Battery Level

The battery level is shown in the control panel and viewfinder.



Control panel



Viewfinder

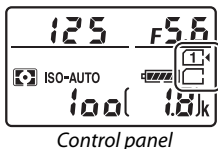
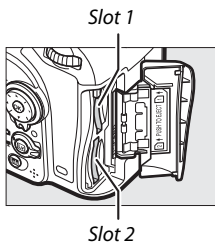
Control panel	Viewfinder	Description
	—	Battery fully charged.
	—	Battery partially discharged.
	—	
	—	
		Low battery. Charge battery or ready spare battery.
 (flashes)	 (flashes)	Shutter release disabled. Charge or exchange battery.

■ ■ Number of Exposures Remaining

The camera has two memory card slots: slot 1 and slot 2. Slot 1 is for the main card; the card in slot 2 plays a backup or secondary role. If the default setting of **Overflow** is selected for **Role played by card in Slot 2** (📖 82) when two memory cards are inserted, the card in slot 2 will only be used when the card in slot 1 is full.

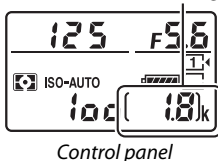
The control panel shows the slot or slots that currently hold a memory card (the example at right shows the icons displayed when a card is inserted in each slot). If the memory card is full or locked or an error has occurred, the icon for the affected card will flash (📖 344).

The control panel and viewfinder show the number of photographs that can be taken at current settings (values over 1000 are rounded down to the nearest hundred; e.g., values between 1800 and 1899 are shown as 1.8 k). If two memory cards are inserted, the displays show the space available on the card in Slot 1.

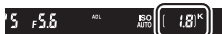


Control panel

Number of exposures remaining



Control panel

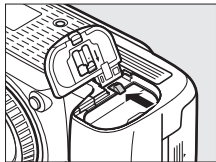


Viewfinder

■ Removing the Battery and Memory Cards

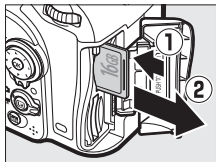
Removing the Battery

Turn the camera off and open the battery-chamber cover. Press the battery latch in the direction shown by the arrow to release the battery and then remove the battery by hand.



Removing Memory Cards

After confirming that the memory card access lamp is off, turn the camera off, open the memory card slot cover, and press the card in and then release it (①). The card can then be removed by hand (②).

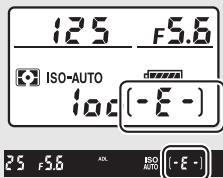


✔ Memory Cards

- Memory cards may be hot after use. Observe due caution when removing memory cards from the camera.
- Turn the power off before inserting or removing memory cards. Do not remove memory cards from the camera, turn the camera off, or remove or disconnect the power source during formatting or while data are being recorded, deleted, or copied to a computer. Failure to observe these precautions could result in loss of data or in damage to the camera or card.
- Do not touch the card terminals with your fingers or metal objects.
- Do not bend, drop, or subject to strong physical shocks.
- Do not apply force to the card casing. Failure to observe this precaution could damage the card.
- Do not expose to water, heat, high levels of humidity, or direct sunlight.
- Do not format memory cards in a computer.

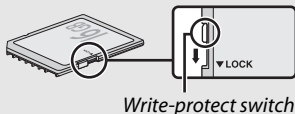
❑ No Memory Card

If no memory card is inserted, the control panel and viewfinder will show [- E -]. If the camera is turned off with a charged battery and no memory card inserted, [- E -] will be displayed in the control panel.



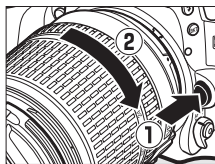
❑ The Write Protect Switch

SD memory cards are equipped with a write protect switch to prevent accidental loss of data. When this switch is in the “lock” position, the memory card can not be formatted and photos can not be deleted or recorded (a warning will be displayed in the monitor if you attempt to release the shutter). To unlock the memory card, slide the switch to the “write” position.



■ Detaching the Lens

Be sure the camera is off when removing or exchanging lenses. To remove the lens, press and hold the lens release button (1) while turning the lens clockwise (2). After removing the lens, replace the lens caps and camera body cap.







❑ CPU Lenses with Aperture Rings

In the case of CPU lenses equipped with an aperture ring (307), lock aperture at the minimum setting (highest f-number).

Basic Photography and Playback

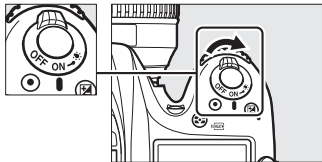
“Point-and-Shoot” Photography (AUTO and Modes)



This section describes how to take photographs in  and  modes.  and  are automatic “point-and-shoot” modes in which the majority of settings are controlled by the camera in response to shooting conditions.



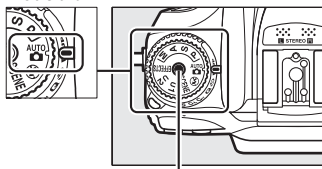
- 1 Turn the camera on.**
The control panel will light.

Power switch





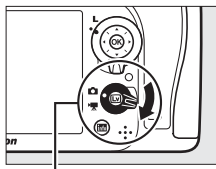
- 2** Pressing the mode dial lock release on top of the camera, rotate the mode dial to  or .

Mode dial

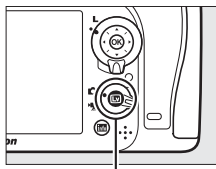


Mode dial lock release

Photographs can be framed in the viewfinder or in the monitor (live view). To start live view, rotate the live view selector to  and press the  button.



Live view selector



 button



Framing pictures in the viewfinder



Framing pictures in the monitor (live view)

3 Ready the camera.

Viewfinder photography: When framing photographs in the viewfinder, hold the handgrip in your right hand and cradle the camera body or lens with your left. Bring your elbows in against the sides of your chest.



Live view: When framing photographs in the monitor, hold the handgrip in your right hand and cradle the lens with your left.



Framing Photographs in Portrait (Tall) Orientation

When framing photographs in portrait (tall) orientation, hold the camera as shown below.



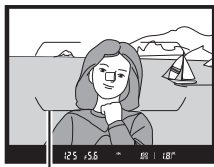
*Framing photographs
in the viewfinder*



*Framing photographs
in the monitor*

4 Frame the photograph.

Viewfinder photography: Frame a photograph in the viewfinder with the main subject in the AF area brackets.



AF area brackets

Live view: At default settings, the camera automatically detects faces and selects the focus point. If no face is detected, use the multi selector to position the focus point over the main subject.

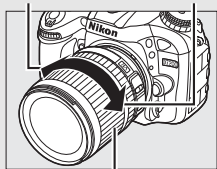


Focus point

Using a Zoom Lens

Use the zoom ring to zoom in on the subject so that it fills a larger area of the frame, or zoom out to increase the area visible in the final photograph (select longer focal lengths on the lens focal length scale to zoom in, shorter focal lengths to zoom out).

Zoom in Zoom out

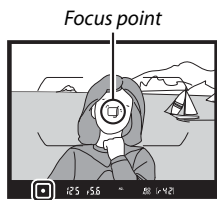


Zoom ring

5 Press the shutter-release button halfway.



Viewfinder photography: Press the shutter-release button halfway to focus (the AF-assist illuminator may light if the subject is poorly lit). When the focus operation is complete, the active focus point and in-focus indicator (●) will appear in the viewfinder.



Focus indicator

In-focus indicator	Description
●	Subject in focus.
▶	Focus point is between camera and subject.
◀	Focus point is behind subject.
▶◀ (flashes)	Camera unable to focus using autofocus. See page 96.

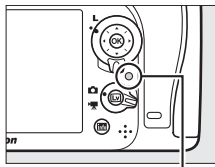
Live view: The focus point flashes green while the camera focuses. If the camera is able to focus, the focus point will be displayed in green; otherwise, the focus point will flash red.



Focus point

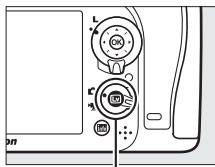
6 Shoot.

Smoothly press the shutter-release button the rest of the way down to take the photograph. The memory card access lamp will light and the photograph will be displayed in the monitor for a few seconds. *Do not eject the memory card or remove or disconnect the power source until the lamp has gone out and recording is complete.*




Memory card access lamp

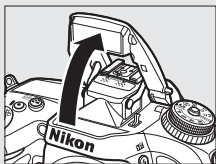
To end live view, press the **[Lv]** button.



[Lv] button

The Built-in Flash

If additional lighting is required for correct exposure in **AUTO** mode, the built-in flash will pop up automatically when the shutter-release button is pressed halfway. If the flash is raised, photographs can only be taken when the flash-ready indicator () is displayed. If the flash-ready indicator is not displayed, the flash is charging; remove your finger briefly from the shutter-release button and try again.

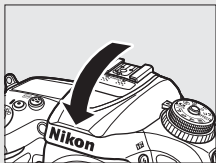


Viewfinder




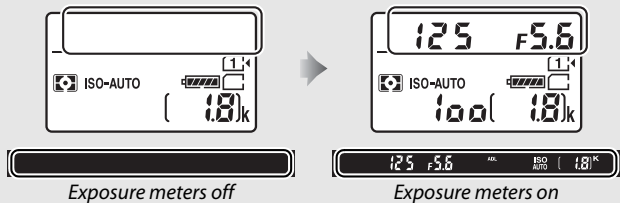
Live view

To save power when the flash is not in use, press it gently downward until the latch clicks into place.




☑ The Standby Timer (Viewfinder Photography)


The viewfinder indicator display and control panel shutter speed and aperture display will turn off if no operations are performed for about six seconds, reducing the drain on the battery. Press the shutter-release button halfway to reactivate the display. The length of time before the standby timer expires automatically can be selected using Custom Setting c2 (**Standby timer**,  279).





☑ The Monitor off Delay (Live View)

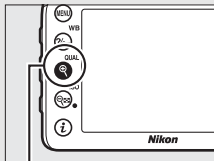
The monitor will turn off if no operations are performed for about ten minutes. The length of time before the monitor turns off automatically can be selected using Custom Setting c4 (**Monitor off delay**,  279) > **Live view**.

☑ Cover the Viewfinder

To prevent light entering via the viewfinder from interfering with photographs and exposure, the rubber eyecup can be removed and the viewfinder covered with the supplied eyepiece cap before shooting ( 70).

Live View Zoom Preview

Press the  (**QUAL**) button to zoom in on the selected focus point to a maximum magnification of about 19 \times . A navigation window will appear in a gray frame at the bottom right corner of the display. Use the multi selector to reposition the focus point or press  (**ISO**) to zoom out.



 (**QUAL**) button




Navigation window

Exposure

Depending on the scene, exposure may differ from that which would be obtained when live view is not used.

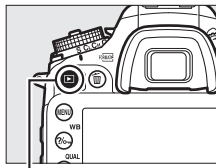
Shooting in Live View

Although they will not appear in the final picture, jagged edges, color fringing, moiré, and bright spots may appear in the monitor, while bright regions or bands may appear in some areas with flashing signs and other intermittent light sources or if the subject is briefly illuminated by a strobe or other bright, momentary light source. In addition, distortion may occur with moving subjects, particularly if the camera is panned horizontally or an object moves horizontally at high speed through the frame. Flicker and banding visible in the monitor under fluorescent, mercury vapor, or sodium lamps can be reduced using **Flicker reduction** ( 290), although they may still be visible in the final photograph at some shutter speeds. Avoid pointing the camera at the sun or other strong light sources. Failure to observe this precaution could result in damage to the camera's internal circuitry.

Basic Playback

1 Press the button.



A photograph will be displayed in the monitor. The memory card containing the picture currently displayed is shown by an icon.



 button




2 View additional pictures.

Additional pictures can be displayed by pressing  or .



To end playback and return to shooting mode, press the shutter-release button halfway.


Image Review

When **On** is selected for **Image review** in the playback menu ( 267), photographs are automatically displayed in the monitor for a few seconds after shooting.

See Also

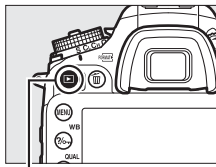
See page 233 for information on choosing a memory card slot.

Deleting Unwanted Photographs

To delete the photograph currently displayed in the monitor, press the  button. *Note that photographs can not be recovered once deleted.*




1 Display the photograph.

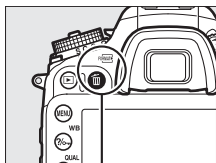
Display the photograph you wish to delete as described on the preceding page.




 button

2 Delete the photograph.




Press the  button. A confirmation dialog will be displayed; press the  button again to delete the image and return to playback. To exit without deleting the picture, press .



 button



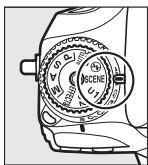
Delete

To delete selected images ( 248), all images taken on a selected date ( 249), or all images in a chosen location on a selected memory card ( 248), use the **Delete** option in the playback menu.

Matching Settings to the Subject or Situation (Scene Mode)

The camera offers a choice of “scene” modes. Choosing a scene mode automatically optimizes settings to suit the selected scene, making creative photography as simple as selecting a mode, framing a picture, and shooting as described on pages 30–35.

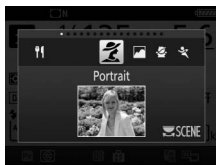
To view the currently selected scene, rotate the mode dial to **SCENE** and press the **info** button. To choose another scene, rotate the main command dial.




Mode dial












Main command dial













Monitor

Note that the scene can not be changed during live view while the live view selector is in the  position.

■ Scenes

Option	Description
 Portrait	Use for portraits with soft, natural-looking skin tones. If the subject is far from the background or a telephoto lens is used, background details will be softened to lend the composition a sense of depth.
 Landscape	Use for vivid landscape shots in daylight. ^{1,2}
 Child	Use for snapshots of children. Clothing and background details are vividly rendered, while skin tones remain soft and natural.
 Sports	Fast shutter speeds freeze motion for dynamic sports shots in which the main subject stands out clearly. ^{1,2}
 Close Up	Use for close-up shots of flowers, insects, and other small objects (a macro lens can be used to focus at very close ranges).
 Night Portrait	Use for a natural balance between the main subject and the background in portraits taken under low light.
 Night Landscape	Reduce noise and unnatural colors when photographing night landscapes, including street lighting and neon signs. ^{1,2}
 Party/Indoor	Capture the effects of indoor background lighting. Use for parties and other indoor scenes.
 Beach/Snow	Capture the brightness of sunlight expanses of water, snow, or sand. ^{1,2}

Option	Description
 Sunset	Preserves the deep hues seen in sunsets and sunrises. ^{1,2}
 Dusk/Dawn	Preserves the colors seen in the weak natural light before dawn or after sunset. ^{1,2}
 Pet Portrait	Use for portraits of active pets. ²
 Candlelight	For photographs taken by candlelight. ¹
 Blossom	Use for fields of flowers, orchards in bloom, and other landscapes featuring expanses of blossoms. ¹
 Autumn Colors	Captures the brilliant reds and yellows in autumn leaves. ¹
 Food	Use for vivid photographs of food. For flash photography, press the  () button to raise the flash ( 146).

1 The built-in flash turns off.

2 The AF-assist illuminator turns off.

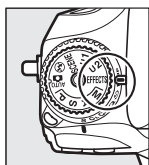
Preventing Blur

Use a tripod to prevent blur caused by camera shake at slow shutter speeds.

Special Effects

Special effects can be used when taking photographs and shooting movies.

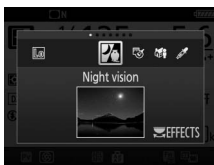
To view the currently selected effect, rotate the mode dial to **EFFECTS** and press the **info** button. To choose another effect, rotate the main command dial.




Mode dial





Main command dial








Monitor

Note that the effect can not be changed during live view while the live view selector is in the  position.

■ ■ Special Effects

Option	Description
 Night Vision	Use under conditions of darkness to record monochrome images at high ISO sensitivities (manual focus is available if the camera is unable to focus). ¹
 Color Sketch	The camera detects and colors outlines for a color sketch effect. The effect can be adjusted in live view (46). Note that movies recorded in this mode play back like a slide show made up of a series of stills.

Option	Description
 Miniature Effect	Create photos that appear to be pictures of dioramas. Works best when shooting from a high vantage point. Miniature effect movies play back at high speed, compressing about 45 minutes of footage shot at 1920 × 1080/30p into a silent movie that plays back in about three minutes. The effect can be adjusted in live view (☐ 47). ^{1,2}
 Selective Color	All colors other than the selected colors are recorded in black and white. The effect can be adjusted in live view (☐ 49). ¹
 Silhouette	Silhouette subjects against bright backgrounds. ¹
 High Key	Use when shooting bright scenes to create bright images that seem filled with light. ¹
 Low Key	Use when shooting dark scenes to create dark, low-key images with prominent highlights. ¹





1 The built-in flash turns off.

2 The AF-assist illuminator turns off.

Preventing Blur

Use a tripod to prevent blur caused by camera shake at slow shutter speeds.

NEF (RAW)

NEF (RAW) recording is not available in , , , and  modes. Pictures taken when an NEF (RAW) or NEF (RAW) + JPEG option is selected in these modes will be recorded as JPEG images. JPEG images created at settings of NEF (RAW) + JPEG will be recorded at the selected JPEG quality, while images recorded at a setting of NEF (RAW) will be recorded as fine-quality images.

and Modes

Autofocus is not available during movie recording. The live view refresh rate will drop, together with the frame rate for continuous release mode; using autofocus during live view will disrupt the preview.

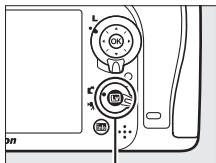
Options Available in Live View

Settings for the selected effect are adjusted in the live view display but apply during live view and viewfinder photography and movie recording.

Color Sketch

1 Select live view.

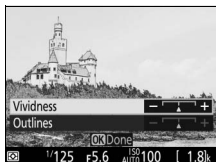
Press the **Lv** button. The view through the lens will be displayed in the monitor.



Lv button

2 Adjust options.

Press **OK** to display the options shown at right. Press **▲** or **▼** to highlight **Vividness** or **Outlines** and press **◀** or **▶** to change. Vividness can be increased to make colors more saturated, or decreased for a washed-out, monochromatic effect, while outlines can be made thicker or thinner. Increasing the thickness of the lines also makes colors more saturated.



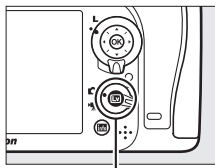
3 Press **OK**.

Press **OK** to exit when settings are complete. To resume viewfinder photography, press the **Lv** button.



1 Select live view.

Press the **Lv** button. The view through the lens will be displayed in the monitor.



Lv button

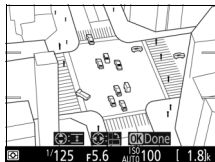
2 Position the focus point.

Use the multi selector to position the focus point in the area that will be in focus and then press the shutter-release button halfway to check focus. To temporarily clear miniature effect options from the display and enlarge the view in the monitor for precise focus, press **QUAL**. Press **ISO** to restore the miniature effect display.







3 Display options.

Press **OK** to display miniature effect options.





4 Adjust options.

Press  or  to choose the orientation of the area that will be in focus and press  or  to adjust its width.



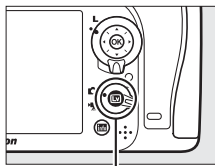
5 Press .

Press  to exit when settings are complete. To resume viewfinder photography, press the  button.



1 Select live view.

Press the **Lv** button. The view through the lens will be displayed in the monitor.



Lv button

2 Display options.

Press **OK** to display selective color options.



3 Select a color.

Frame an object in the white square in the center of the display and press **OK** to choose the color of the object as one that will remain in the final image (the camera may have difficulty detecting unsaturated colors; choose a saturated color). To zoom in on the center of the display for more precise color selection, press **OK** (**QUAL**). Press **ISO** to zoom out.

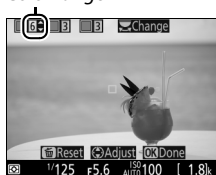
Selected color



4 Choose the color range.

Press or to increase or decrease the range of similar hues that will be included in the final image. Choose from values between 1 and 7; note that higher values may include hues from other colors.

Color range



5 Select additional colors.

To select additional colors, rotate the main command dial to highlight another of the three color boxes at the top of the display and repeat Steps 3 and 4 to



select another color. Repeat for a third color if desired. To deselect the highlighted color, press (FORMAT). To remove all colors, press and hold (FORMAT). A confirmation dialog will be displayed; select **Yes**.



6 Press .

Press to exit when settings are complete. During shooting, only objects of the selected hues will be recorded in color; all others will be recorded in black-and-white. To resume viewfinder photography, press the button.



P, S, A, and M Modes

P, S, A, and M modes offer different degrees of control over shutter speed and aperture.



Mode	Description
P	Programmed auto (□ 52): Camera sets shutter speed and aperture for optimal exposure. Recommended for snapshots and in other situations in which there is little time to adjust camera settings.
S	Shutter-priority auto (□ 53): User chooses shutter speed; camera selects aperture for best results. Use to freeze or blur motion.
A	Aperture-priority auto (□ 54): User chooses aperture; camera selects shutter speed for best results. Use to blur background or bring both foreground and background into focus.
M	Manual (□ 56): User controls both shutter speed and aperture. Set shutter speed to Bulb (b u l b) or Time (- -) for long time-exposures.

🔍 Lens Types



When using a CPU lens equipped with an aperture ring (□ 307), lock the aperture ring at the minimum aperture (highest f-number). Type G and E lenses are not equipped with an aperture ring.

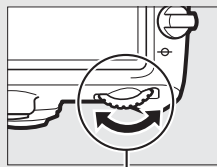
Non-CPU lenses can only be used in modes A (aperture-priority auto) and M (manual), when aperture can only be adjusted using the lens aperture ring. Selecting any other mode disables the shutter release. For more information, see “Compatible Lenses” (□ 304).

P: Programmed Auto

In this mode, the camera automatically adjusts shutter speed and aperture according to a built-in program to ensure optimal exposure in most situations.

Flexible Program

In mode **P**, different combinations of shutter speed and aperture can be selected by rotating the main command dial while the exposure meters are on (“flexible program”). Rotate the dial to the right for large apertures (low f-numbers) that blur background details or fast shutter speeds that “freeze” motion. Rotate the dial to the left for small apertures (high f-numbers) that increase depth of field or slow shutter speeds that blur motion. All combinations produce the same exposure. While flexible program is in effect, a flexible program indicator ( or ) is displayed. To restore default shutter speed and aperture settings, rotate the main command dial until the indicator is no longer displayed, choose another mode, or turn the camera off.



Main command dial



Viewfinder

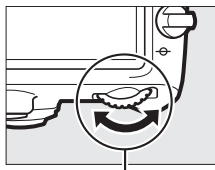


Monitor

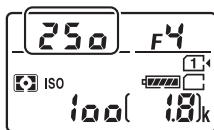
S: Shutter-Priority Auto

In shutter-priority auto, you choose the shutter speed while the camera automatically selects the aperture that will produce the optimal exposure.

To choose a shutter speed, rotate the main command dial while the exposure meters are on. Shutter speed can be set to "x 250" or to values between 30 s and $\frac{1}{8000}$ S.



Main command dial



Control panel



Monitor

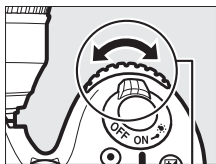
See Also

See page 343 for information on what to do if flashing "b w L b" or "- -" indicator appears in the shutter-speed displays.

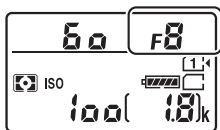
A: Aperture-Priority Auto

In aperture-priority auto, you choose the aperture while the camera automatically selects the shutter speed that will produce the optimal exposure.

To choose an aperture between the minimum and maximum values for the lens, rotate the sub-command dial while the exposure meters are on.



Sub-command dial



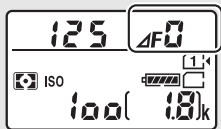
Control panel



Monitor

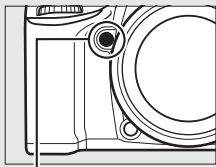
Non-CPU Lenses (308)

Use the lens aperture ring to adjust aperture. If the maximum aperture of the lens has been specified using the **Non-CPU lens data** item in setup menu (224) when a non-CPU lens is attached, the current f-number will be displayed, rounded to the nearest full stop. Otherwise the aperture displays will show only the number of stops (ΔF , with maximum aperture displayed as $\Delta F\bar{0}$) and the f-number must be read from the lens aperture ring.




Depth-of-Field Preview (Viewfinder Photography)

To preview the effects of aperture, press and hold the **Pv** button. The lens will be stopped down to the aperture value selected by the camera (modes **P** and **S**) or the value chosen by the user (modes **A** and **M**), allowing depth of field to be previewed in the viewfinder.



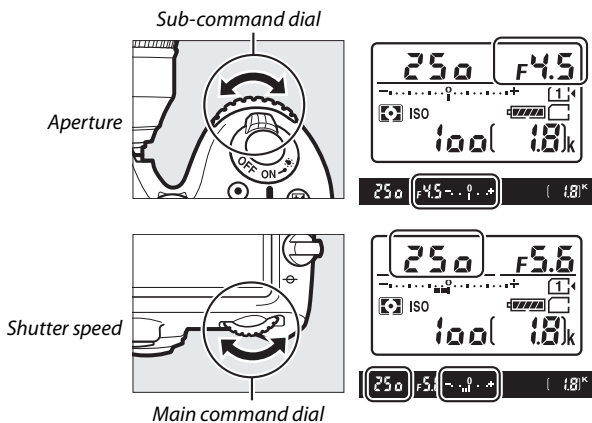
Pv button

Custom Setting e5—Modeling Flash (Viewfinder Photography; 284)

This setting controls whether the built-in flash and optional flash units that support the Nikon Creative Lighting System (CLS;  311) will emit a modeling flash when the **Pv** button is pressed.

M: Manual

In manual exposure mode, you control both shutter speed and aperture. While the exposure meters are on, rotate the main command dial to choose a shutter speed, and the sub-command dial to set aperture. Shutter speed can be set to "x 250" or to values between 30 s and $\frac{1}{8000}$ s, or the shutter can be held open indefinitely for a long time-exposure (b u L b or - -, 58). Aperture can be set to values between the minimum and maximum values for the lens. Use the exposure indicators to check exposure.



AF Micro NIKKOR Lenses

Provided that an external exposure meter is used, the exposure ratio need only be taken into account when the lens aperture ring is used to set aperture.

🔍 The Exposure Indicators

If a shutter speed other than “bulb” or “time” is selected, the exposure indicators show whether the photograph would be under- or over-exposed at current settings. Depending on the option chosen for Custom Setting b2 (**EV steps for exposure ctrl**, 📖 278), the amount of under- or over-exposure is shown in increments of $\frac{1}{3}$ EV or $\frac{1}{2}$ EV. If the limits of the exposure metering system are exceeded, the exposure indicators and the shutter speed (modes **P** and **A**) and/or aperture (modes **P** and **S**) displays will flash.

	Custom Setting b2 set to $\frac{1}{3}$ step		
	Optimal exposure	Underexposed by $\frac{1}{3}$ EV	Overexposed by 2 EV
Control panel			
Viewfinder (viewfinder photography)			
Monitor (live view)			

🔍 See Also

For information on reversing the exposure indicators so that negative values are displayed on the right and positive values on the left, see Custom Setting f8 (**Reverse indicators**, 📖 286).

Long Time-Exposures (M Mode Only)

Select the following shutter speeds for long time-exposures of moving lights, the stars, night scenery, or fireworks.

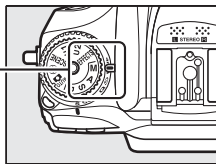
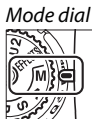
- **Bulb** (b, L, b): The shutter remains open while the shutter-release button is held down. To prevent blur, use a tripod or an optional wireless remote controller (☞ 160, 319) or remote cord (☞ 319).
- **Time** (- -): Start the exposure using the shutter-release button on the camera or on an optional remote control, remote cord, or wireless remote controller. The shutter remains open until the button is pressed a second time.

Before proceeding, mount the camera on a tripod or place it on a stable, level surface. To prevent light entering via the viewfinder from appearing in the photograph or interfering with exposure, remove the rubber eyecup and cover the viewfinder with the supplied eyepiece cap (☞ 70). Note that noise (bright spots, randomly-spaced bright pixels, or fog) may be present in long exposures. Bright spots and fog can be reduced by choosing **On** for **Long exposure NR** in the photo shooting menu (☞ 271).



*Length of exposure: 35 s
Aperture: f/25*

1 Rotate the mode dial to M.

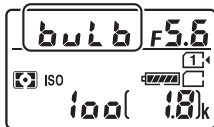


2 Choose a shutter speed.

While the exposure meters are on, rotate the main command dial to choose a shutter speed of "Bulb" (b u l b).



Main command dial



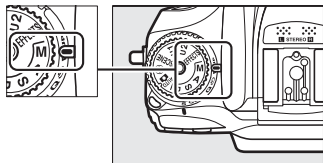
Control panel



Monitor

3 Take the photograph.

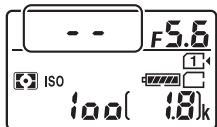
After focusing, press the shutter-release button on the camera or on the optional wireless remote controller or remote cord all the way down. Remove your finger from the shutter-release button when the exposure is complete.

1 Rotate the mode dial to M. *Mode dial***2** Choose a shutter speed.

While the exposure meters are on, rotate the main command dial left to choose a shutter speed of "Time" (- -).



Main command dial



Control panel



Monitor

3 Open the shutter.

After focusing, press the shutter-release button on the camera or optional remote control, remote cord, or wireless remote controller all the way down.

4 Close the shutter.

Repeat the operation performed in Step 3.

ML-L3 Remote Controls

If you will be using an ML-L3 remote control, select a remote control mode (**Delayed remote**, **Quick-response remote**, or **Remote mirror-up**) using the **Remote control mode (ML-L3)** option in the photo shooting menu (☐ 156). Note that if you are using an ML-L3 remote control, pictures will be taken in “Time” mode even when “Bulb”/bulb is selected for shutter speed. The exposure starts when the shutter-release button on the remote control is pressed and ends after 30 minutes or when the button is pressed again.

User Settings: U1 and U2 Modes

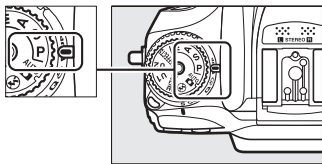
Assign frequently-used settings to the **U1** and **U2** positions on the mode dial.

Saving User Settings

1 Select a mode.

Rotate the mode dial to the desired mode.

Mode dial



2 Adjust settings.

Make the desired adjustments to flexible program (mode **P**), shutter speed (modes **S** and **M**), aperture (modes **A** and **M**), exposure and flash compensation, flash mode, focus point, metering, autofocus and AF-area modes, bracketing, and settings in the shooting and Custom Settings menus.

User Settings

The following can not be saved to **U1** or **U2**.


Photo shooting menu:

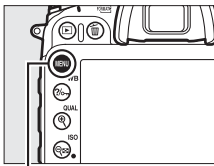
- Reset photo shooting menu
- Storage folder
- Image area
- Manage Picture Control
- Remote control mode (ML-L3)
- Multiple exposure
- Interval timer shooting

Movie shooting menu:

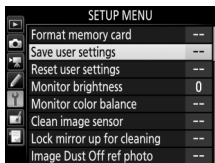
- Reset movie shooting menu
- Image area
- Manage Picture Control
- Time-lapse photography

3 Select **Save user settings**.

Press the **MENU** button to display the menus. Highlight **Save user settings** in the setup menu and press .

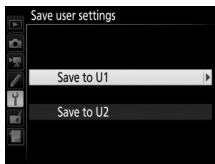


MENU button




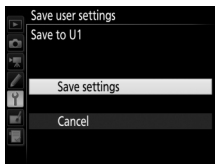
4 Select **Save to U1** or **Save to U2**.

Highlight **Save to U1** or **Save to U2** and press .



5 Save user settings.

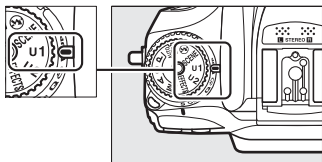
Highlight **Save settings** and press  to assign the settings selected in Steps 1 and 2 to the mode dial position selected in Step 4.



Recalling User Settings

Simply rotate the mode dial to **U1** to recall the settings assigned to **Save to U1**, or to **U2** to recall the settings assigned to **Save to U2**.

Mode dial

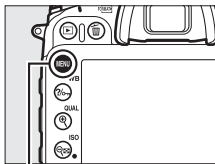


Resetting User Settings

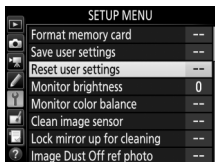
To reset settings for **U1** or **U2** to default values:

1 Select **Reset user settings**.


Press the **MENU** button to display the menus. Highlight **Reset user settings** in the setup menu and press .

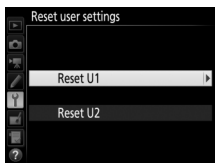


MENU button



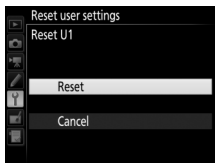
2 Select **Reset U1** or **Reset U2**.

Highlight **Reset U1** or **Reset U2** and press .



3 Reset user settings.

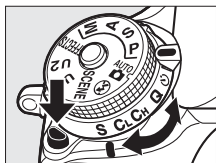
Highlight **Reset** and press .




Release Mode

Choosing a Release Mode

To choose a release mode, press the release mode dial lock release and turn the release mode dial to the desired setting.



Mode	Description
S	Single frame: Camera takes one photograph each time shutter-release button is pressed.
CL	Continuous low speed: While shutter-release button is held down, camera takes photographs at frame rate selected for Custom Setting d2 (Continuous low-speed , □ 67, 280). Note that only one picture will be taken if the flash fires.
CH	Continuous high speed: While shutter-release button is held down, camera records photographs at frame rate given on page 67. Use for active subjects. Note that only one picture will be taken if the flash fires.
Q	Quiet shutter-release: As for single frame, except that mirror does not click back into place while shutter-release button is fully pressed, allowing user to control timing of click made by mirror, which is also quieter than in single frame mode. In addition, beep does not sound regardless of setting selected for Custom Setting d1 (Beep ; □ 280).
	Self-timer: Take pictures with the self-timer (□ 69).
MUP	Mirror up: Choose this mode to minimize camera shake in telephoto or close-up photography or in other situations in which the slightest camera movement can result in blurred photographs (□ 71).

Frame Advance Rate

The frame rate for continuous shooting (low and high speed) varies with the option chosen for image area (☐ 73) and, when an NEF (RAW) image quality option is selected, the NEF (RAW) bit depth (☐ 80). The table below gives the approximate frame rates for a fully-charged EN-EL15 battery, continuous-servo AF, manual or shutter-priority auto exposure, a shutter speed of $\frac{1}{250}$ s or faster, and the remaining settings at default values.

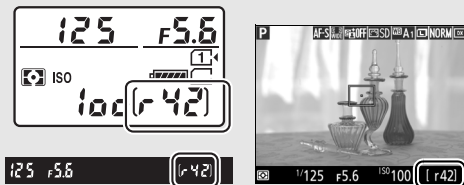
Image area	Image quality	Approximate frame advance rate	
		CL	CH
DX (24×16)	JPEG/12-bit NEF (RAW)	1–6 fps	6 fps
	14-bit NEF (RAW)	1–5 fps	5 fps
1.3× (18×12)	JPEG/12-bit NEF (RAW)	1–6 fps	7 fps
	14-bit NEF (RAW)		6 fps

Frame rates may drop at extremely small apertures (high f-numbers) or slow shutter speeds, when vibration reduction (available with VR lenses) or auto ISO sensitivity control (☐ 102) is on, or when the battery is low, a non-CPU lens is attached, or **Aperture ring** is selected for Custom Setting f5 (**Customize command dials**) > **Aperture setting** (☐ 285). The maximum frame rate in live view is 3.7 fps.

The Memory Buffer

The camera is equipped with a memory buffer for temporary storage, allowing shooting to continue while photographs are being saved to the memory card. The frame rate will drop when the buffer is full (r00).

The approximate number of images that can be stored in the buffer at current settings is shown in the exposure-count displays while the shutter-release button is pressed. The illustrations below show the display when space remains in the buffer for about 42 pictures.




While photographs are being recorded to the memory card, the memory card access lamp will light. Depending on shooting conditions and memory card performance, recording may take from a few seconds to a few minutes. *Do not remove the memory card or remove or disconnect the power source until the access lamp has gone out.* If the camera is switched off while data remain in the buffer, the power will not turn off until all images in the buffer have been recorded. If the battery is exhausted while images remain in the buffer, the shutter release will be disabled and the images transferred to the memory card.

Live View

If a continuous release mode is used during live view, photographs will be displayed in place of the view through the lens while the shutter-release button is pressed.

See Also

For information on choosing the maximum number of photographs that can be taken in a single burst, see Custom Setting d3 (**Max. continuous release**,  280). For information on the number of pictures that can be taken in a single burst, see page 380.

Self-Timer Mode (☺)

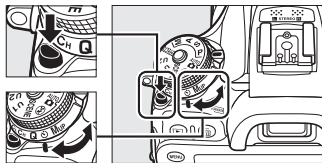
The self-timer can be used to reduce camera shake or for self-portraits.

1 Mount the camera on a tripod.

Mount the camera on a tripod or place the camera on a stable, level surface.

2 Select self-timer mode.

Press the release mode dial lock release and turn the release mode dial to ☺.



Release mode dial

3 Frame the photograph and focus.

The self-timer can not be used if the camera is unable to focus using single-servo AF or in other situations in which the shutter can not be released.



4 Start the timer.

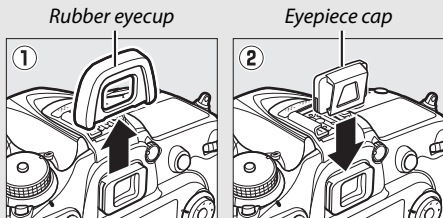
Press the shutter-release button all the way down to start the timer. The self-timer lamp will start to flash. Two seconds before the photograph is taken, the self-timer lamp will stop flashing. The shutter will be released about ten seconds after the timer starts.





To turn the self-timer off before a photograph is taken, turn the release mode dial to another setting.

Cover the Viewfinder

When taking photos without your eye to the viewfinder, remove the rubber eyecup (①) and insert the supplied eyepiece cap as shown (②). This prevents light entering via the viewfinder from appearing in photographs or interfering with exposure. Hold the camera firmly when removing the rubber eyecup.



Using the Built-in Flash

Before taking a photograph with the flash in modes that require the flash to be raised manually, press the  button to raise the flash and wait for the flash-ready indicator () to be displayed (□ 146). Shooting will be interrupted if the flash is raised after the self-timer has started. Note that only one photograph will be taken when the flash fires, regardless of the number of exposures selected for Custom Setting c3 (**Self-timer**; □ 279).

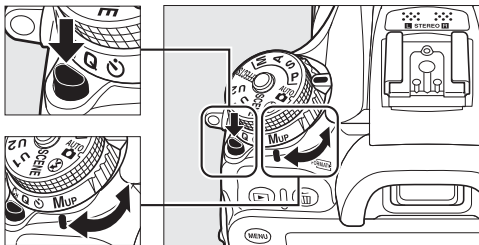
See Also

For information on choosing the duration of the self-timer, the number of shots taken, and the interval between shots, see Custom Setting c3 (**Self-timer**; □ 279). For information on controlling the beeps that sound when the self-timer is used, see Custom Setting d1 (**Beep**; □ 280).

Mirror up Mode (MUP)

Choose this mode to minimize blurring caused by camera movement when the mirror is raised. To use mirror-up mode, press the release mode dial lock release and rotate the release mode dial to **MUP** (mirror up).

Release mode dial lock release



Release mode dial

After pressing the shutter-release button halfway to set focus and exposure, press the shutter-release button the rest of the way down. The viewfinder or monitor will turn off; in viewfinder photography, the mirror will be raised. Press the shutter-release button all the way down again to take the picture. When shooting ends, either live view will resume or (in viewfinder photography) the mirror will lower.

Mirror Up

While the mirror is raised, photos can not be framed in the viewfinder and autofocus and metering will not be performed.

Mirror up Mode

A picture will be taken automatically if no operations are performed for about 30 s with the mirror raised.




Preventing Blur

To prevent blurring caused by camera movement, press the shutter-release button smoothly, or use an optional remote cord (□ 319). For information on using the optional ML-L3 remote control for mirror-up photography, see page 156. Use of a tripod is recommended.

Image Recording Options

Image Area

Choose an image area from **DX (24×16)** and **1.3× (18×12)**.

Option	Description
 DX (24×16)	Pictures are recorded using a 23.5 × 15.6 mm image area (DX format).
 1.3× (18×12)	Pictures are recorded using a 18.8 × 12.5 mm image area, producing a telephoto effect without the need to change lenses. The camera can also record more images per second during continuous shooting ( 67).

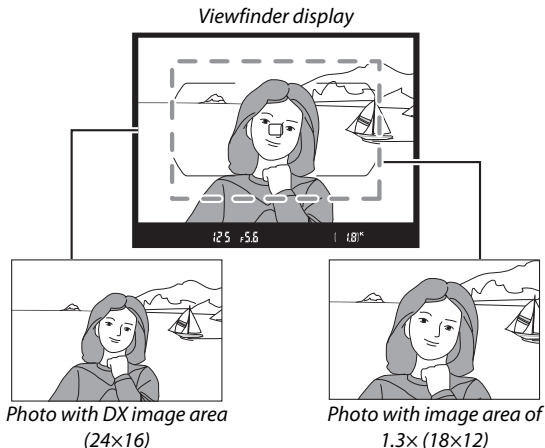
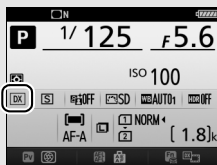


Image Area

The selected option is shown in the display.




Information display



Shooting display


The Viewfinder Display

The viewfinder display for the 1.3× DX crop is shown at right. A  icon is displayed in the viewfinder when the 1.3× DX crop is selected.



1.3× DX crop


See Also

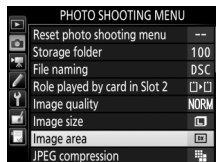
See page 168 for information on the crops available when the live view selector is rotated to . See page 380 for information on the number of pictures that can be stored at different image area settings.

The image area can be selected using the **Image area** option in the shooting menus or by pressing a control and rotating a command dial.



■ The Image Area Menu

1 Select Image area.

Highlight **Image area** in either of the shooting menus and press .



2 Adjust settings.

Choose an option and press . The selected crop is displayed in the viewfinder ( 74).

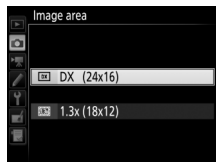



Image Size

Image size varies with the option selected for image area ( 81).

■ Camera Controls

In viewfinder photography, the image area can also be selected with the **Fn** button and command dials.

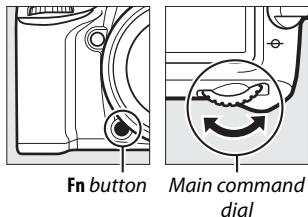
1 Assign image area selection to a camera control.

Select **Choose image area** as the “Press + command dials” option for a camera control in the Custom Settings menu.

Image area selection can be assigned to the **Fn** button (Custom Setting f2, **Assign Fn button**, [□ 284](#)), the **Pv** button (Custom Setting f3, **Assign preview button**, [□ 285](#)), or the **AE-L/AF-L** button (Custom Setting f4, **Assign AE-L/AF-L button**, [□ 285](#)).

2 Use the selected control to choose an image area.

The image area can be selected by pressing the selected button and rotating the main or sub-command dial until the desired crop is displayed in the viewfinder ([□ 74](#)).



The option currently selected for image area can be viewed by pressing the button to display the image area in the control panel, viewfinder, or information display.

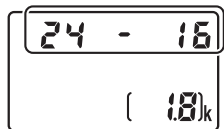


Image Quality and Size

Together, image quality and size determine how much space each photograph occupies on the memory card. Larger, higher quality images can be printed at larger sizes but also require more memory, meaning that fewer such images can be stored on the memory card (📖 380).

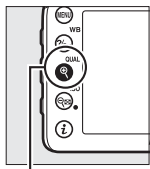
Image Quality

Choose a file format and compression ratio (image quality).

Option	File type	Description
NEF (RAW)	NEF	Raw data from the image sensor are saved without additional processing. Settings such as white balance and contrast can be adjusted after shooting.
JPEG fine	JPEG	Record JPEG images at a compression ratio of roughly 1 : 4 (fine quality).*
JPEG normal		Record JPEG images at a compression ratio of roughly 1 : 8 (normal quality).*
JPEG basic		Record JPEG images at a compression ratio of roughly 1 : 16 (basic quality).*
NEF (RAW) + JPEG fine	NEF/ JPEG	Two images are recorded, one NEF (RAW) image and one fine-quality JPEG image.
NEF (RAW) + JPEG normal		Two images are recorded, one NEF (RAW) image and one normal-quality JPEG image.
NEF (RAW) + JPEG basic		Two images are recorded, one NEF (RAW) image and one basic-quality JPEG image.

* **Size priority** selected for **JPEG compression**. The compression ratio is an approximation only; the actual ratio varies with ISO sensitivity and the scene recorded.

Image quality can be set by pressing the **QUAL** button and rotating the main command dial until the desired setting is displayed in the information display.



QUAL button



Main command dial



Information display


NEF (RAW) Images

The option selected for image size does not affect the size of NEF (RAW) images. JPEG copies of NEF (RAW) images can be created using Capture NX-D or other software or the **NEF (RAW) processing** option in the retouch menu (☰ 295).


NEF+JPEG

When photographs taken at settings of NEF (RAW) + JPEG are viewed on the camera with only one memory card inserted, only the JPEG image will be displayed. If both copies are recorded to the same memory card, both copies will be erased when the photo is deleted. If the JPEG copy is recorded to a separate memory card using the **Role played by card in Slot 2 > RAW Slot 1 - JPEG Slot 2** option, deleting the JPEG copy will not delete the NEF (RAW) image.


+ NEF (RAW)



If + **NEF (RAW)** is assigned to the **Fn** button using Custom Setting f2 (**Assign Fn button**,  284) > **Press** and a JPEG option is selected for image quality, an NEF (RAW) copy will be recorded with the next photograph taken after the **Fn** button is pressed (the original image quality setting will be restored when you remove your finger from the shutter-release button). To exit without recording an NEF (RAW) copy, press the **Fn** button again.

The Photo Shooting Menu


Image quality can also be adjusted using the **Image quality** option in the photo shooting menu ( 268).



■ ■ JPEG Compression

To choose the type of compression for JPEG images, highlight **JPEG compression** in the photo shooting menu and press .


Option	Description
 Size priority	Images are compressed to produce relatively uniform file size.
 Optimal quality	Optimal image quality. File size varies with scene recorded.

■ ■ Type

To choose the type of compression for NEF (RAW) images, highlight **NEF (RAW) recording > Type** in the photo shooting menu and press .

Option	Description
ON  Lossless compressed	NEF images are compressed using a reversible algorithm, reducing file size by about 20–40% with no effect on image quality.
ON  Compressed	NEF images are compressed using a non-reversible algorithm, reducing file size by about 35–55% with almost no effect on image quality.

■ ■ NEF (RAW) Bit Depth

To choose a bit depth for NEF (RAW) images, highlight **NEF (RAW) recording > NEF (RAW) bit depth** in the photo shooting menu and press .

Option	Description
12-bit 12-bit	NEF (RAW) images are recorded at a bit-depth of 12 bits.
14-bit 14-bit	NEF (RAW) images are recorded at a bit depth of 14 bits, producing files larger than those with a bit depth of 12 bits but increasing the color data recorded.

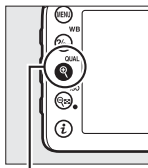
Image Size

Image size is measured in pixels. Choose from **L** Large, **M** Medium, or **S** Small (note that image size varies depending on the option selected for **Image area**, [73](#)):

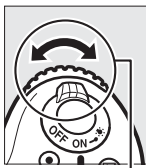
Image area	Option	Size (pixels)	Print size (cm/in.)*
DX (24×16)	Large	6000 × 4000	50.8 × 33.9/20.0 × 13.3
	Medium	4496 × 3000	38.1 × 25.4/15.0 × 10.0
	Small	2992 × 2000	25.3 × 16.9/10.0 × 6.7
1.3× (18×12)	Large	4800 × 3200	40.6 × 27.1/16.0 × 10.7
	Medium	3600 × 2400	30.5 × 20.3/12.0 × 8.0
	Small	2400 × 1600	20.3 × 13.5/ 8.0 × 5.3

* Approximate size when printed at 300 dpi. Print size in inches equals image size in pixels divided by printer resolution in dots per inch (dpi; 1 inch = approximately 2.54 cm).

Image size can be set by pressing the **QUAL** button and rotating the sub-command dial until the desired setting is displayed in the information display.



QUAL button



Sub-command dial



Information display

The Photo Shooting Menu

Image size can also be adjusted using the **Image size** option in the photo shooting menu ([269](#)).

Using Two Memory Cards

When two memory cards are inserted in the camera, you can use the **Role played by card in Slot 2** item in the photo shooting menu to choose the role played by the card in Slot 2. Choose from **Overflow** (the card in Slot 2 is used only when the card in Slot 1 is full), **Backup** (each picture is recorded twice, once to the card in Slot 1 and again to the card in Slot 2), and **RAW Slot 1 - JPEG Slot 2** (as for **Backup**, except that the NEF/RAW copies of photos recorded at settings of NEF/RAW + JPEG are recorded only to the card in Slot 1 and the JPEG copies only to the card in Slot 2).

"Backup" and "RAW Slot 1 - JPEG Slot 2"

The camera shows the number of exposures remaining on the card with the least amount of memory. Shutter release will be disabled when either card is full.

Recording Movies

When two memory cards are inserted in the camera, the slot used to record movies can be selected using the **Destination** option in the movie shooting menu (📖 273).

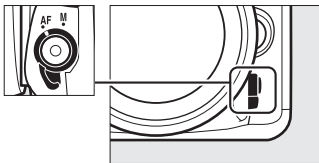
Focus

Focus can be adjusted automatically (see below) or manually (☞ 97). The user can also select the focus point for automatic or manual focus (☞ 89) or use focus lock to focus to recompose photographs after focusing (☞ 93).

Autofocus

To use autofocus, rotate the focus-mode selector to **AF**.

Focus-mode selector



Autofocus Mode

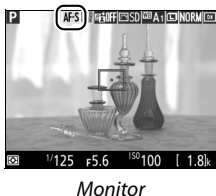
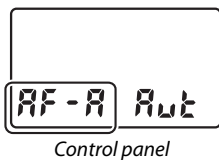
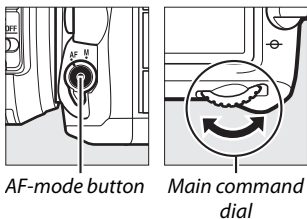
The following autofocus modes can be selected during viewfinder photography:

Mode	Description
AF-A	Auto-servo AF: Camera automatically selects single-servo autofocus if subject is stationary, continuous-servo autofocus if subject is moving.
AF-S	Single-servo AF: For stationary subjects. Focus locks when shutter-release button is pressed halfway. At default settings, shutter can only be released when in-focus indicator (●) is displayed (<i>focus priority</i> ; ☞ 276).
AF-C	Continuous-servo AF: For moving subjects. Camera focuses continuously while shutter-release button is pressed halfway; if subject moves, camera will engage <i>predictive focus tracking</i> (☞ 85) to predict final distance to subject and adjust focus as necessary. At default settings, shutter can be released whether or not subject is in focus (<i>release priority</i> ; ☞ 276).

The following autofocus modes can be selected during live view:

Mode	Description
AF-S	Single-servo AF: For stationary subjects. Focus locks when shutter-release button is pressed halfway.
AF-F	Full-time servo AF: For moving subjects. Camera focuses continuously until shutter-release button is pressed. Focus locks when shutter-release button is pressed halfway.

Autofocus mode can be selected by pressing the AF-mode button and rotating the main command dial until the desired setting is displayed.



Predictive Focus Tracking (Viewfinder Photography)

In **AF-C** mode or when continuous-servo autofocus is selected in **AF-A** mode, the camera will initiate predictive focus tracking if the subject moves toward or away from the camera while the shutter-release button is pressed halfway. This allows the camera to track focus while attempting to predict where the subject will be when the shutter is released.

See Also

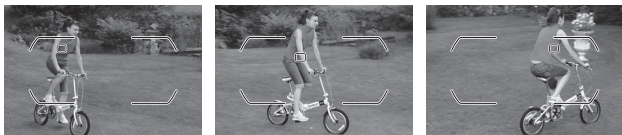
For information on using focus priority in continuous-servo AF, see Custom Setting a1 (**AF-C priority selection**, □ 276). For information on using release priority in single-servo AF, see Custom Setting a2 (**AF-S priority selection**, □ 276). See Custom Setting f5 (**Customize command dials**) > **Change main/sub** (□ 285) for information on using the sub-command dial to choose the focus mode.

AF-Area Mode

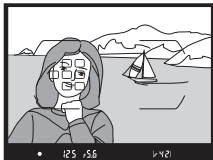
AF-area mode controls how the camera selects the focus-point for autofocus. The following options are available during viewfinder photography:

- **Single-point AF:** Select the focus point as described on page 89; the camera will focus on the subject in the selected focus point only. Use with stationary subjects.
- **Dynamic-area AF:** Select the focus point as described on page 89. In **AF-A** and **AF-C** focus modes, the camera will focus based on information from surrounding focus points if the subject briefly leaves the selected point. The number of focus points varies with the mode selected:
 - **9-point dynamic-area AF:** Choose when there is time to compose the photograph or when photographing subjects that are moving predictably (e.g., runners or race cars on a track).
 - **21-point dynamic-area AF:** Choose when photographing subjects that are moving unpredictably (e.g., players at a football game).
 - **51-point dynamic-area AF:** Choose when photographing subjects that are moving quickly and can not be easily framed in the viewfinder (e.g., birds).

- **3D-tracking:** Select the focus point as described on page 89. In **AF-A** and **AF-C** focus modes, the camera will track subjects that leave the selected focus point and select new focus points as required. Use to quickly compose pictures with subjects that are moving erratically from side to side (e.g., tennis players). If the subject leaves viewfinder, remove your finger from the shutter-release button and recompose the photograph with the subject in the selected focus point.






- **Auto-area AF:** The camera automatically detects the subject and selects the focus point (in the case of portrait subjects, the camera is able to distinguish the subject from the background for improved subject detection). The active focus points are highlighted briefly after the camera focuses; in **AF-C** mode or when continuous-servo autofocus is selected in **AF-A** mode, the main focus point remains highlighted after the other focus points have turned off.






3D-tracking

When the shutter-release button is pressed halfway, the colors in the area surrounding the focus point are stored in the camera. Consequently 3D-tracking may not produce the desired results with subjects that are similar in color to the background or that occupy a very small area of the frame.

The following AF-area modes can be selected during live view:

-  **Face-priority AF:** Use for portraits. The camera automatically detects and focuses on portrait subjects; the selected subject is indicated by a double yellow border (if multiple faces are detected, the camera will focus on the closest subject; to choose a different subject, use the multi selector). If the camera can no longer detect the subject (because, for example, the subject has turned to face away from the camera), the border will no longer be displayed.
-  **Wide-area AF:** Use for hand-held shots of landscapes and other non-portrait subjects.
-  **Normal-area AF:** Use for pin-point focus on a selected spot in the frame. A tripod is recommended.

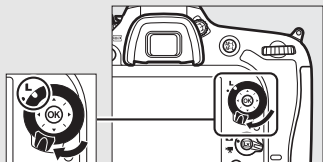


-  **Subject-tracking AF:** Use the multi selector to position the focus point over your subject and press  to start tracking. The focus point will track the selected subject as it moves through the frame. To end tracking, press  again. Note that the camera may be unable to track subjects if they move quickly, leave the frame or are obscured by other objects, change visibly in size, color, or brightness, or are too small, too large, too bright, too dark, or similar in color or brightness to the background.



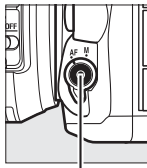
Manual Focus-Point Selection

The multi selector can be used to select the focus point. Rotating the focus selector lock to **L** disables manual focus-point selection.



Focus selector lock

AF-area mode can be selected by pressing the AF-mode button and rotating the sub-command dial until the desired setting is displayed.



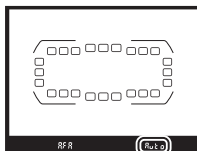
AF-mode button



Sub-command dial



Control panel



Viewfinder



Monitor

AF-Area Mode (Viewfinder Photography)

AF-area mode is shown in the control panel and viewfinder.

AF-area mode	Control panel	Viewfinder
Single-point AF	S	S
9-point dynamic-area AF *	d 9	d 9
21-point dynamic-area AF *	d2 1	d2 1
51-point dynamic-area AF *	d5 1	d5 1
3D-tracking	3d	3d
Auto-area AF	Auto	Auto

* Only active focus point is displayed in the viewfinder. Remaining focus points provide information to assist focus operation.

✔ Using Autofocus in Live View

Use an AF-S lens. The desired results may not be achieved with other lenses or teleconverters. Note that in live view, autofocus is slower and the monitor may brighten or darken while the camera focuses. The focus point may sometimes be displayed in green when the camera is unable to focus. The camera may be unable to focus in the following situations:

- The subject contains lines parallel to the long edge of the frame
- The subject lacks contrast
- The subject in the focus point contains areas of sharply contrasting brightness, or includes spot lighting or a neon sign or other light source that changes in brightness
- Flicker or banding appears under fluorescent, mercury-vapor, sodium-vapor, or similar lighting
- A cross (star) filter or other special filter is used
- The subject appears smaller than the focus point
- The subject is dominated by regular geometric patterns (e.g., blinds or a row of windows in a skyscraper)
- The subject is moving

✍ Focus-Point Selection

Except in subject-tracking AF, pressing **OK** during focus-point selection selects the center focus point. In subject-tracking AF, pressing **OK** starts subject tracking instead. Manual focus-point selection is not available in auto-area AF or if a face is detected when face-priority AF is selected in live view.

See Also

Viewfinder photography: For information on choosing when the focus point is illuminated, see Custom Setting a5 (**Focus point illumination**) > **AF point illumination** (☐ 277). For information on setting focus-point selection to “wrap around,” see Custom Setting a6 (**Focus point wrap-around**, ☐ 277). For information on choosing the number of focus points that can be selected using the multi selector, see Custom Setting a7 (**Number of focus points**, ☐ 277). For information on choosing separate focus points for vertical and horizontal orientations, see Custom Setting a8 (**Store points by orientation**, ☐ 277).

Viewfinder photography/live view: See Custom Setting f5 (**Customize command dials**) > **Change main/sub** (☐ 285) for information on using the main command dial to choose the AF-area mode.

Focus Lock

Focus lock can be used to change the composition after focusing, making it possible to focus on a subject that will not be in a focus point in the final composition. If the camera is unable to focus using autofocus (☞ 96), focus lock can also be used to recompose the photograph after focusing on another object at the same distance as your original subject. Focus lock is most effective when an option other than auto-area AF is selected for AF-area mode (☞ 86).

1 Focus.

Position the subject in the selected focus point and press the shutter-release button halfway to initiate focus. Check that the in-focus indicator (●) appears in the viewfinder (viewfinder photography) or that the focus point has turned green (live view).



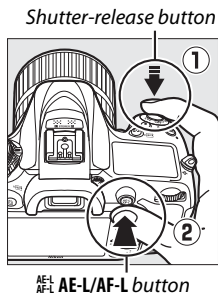
Viewfinder photography



Live view

2 Lock focus.

AF-A and AF-C focus modes (viewfinder photography): With the shutter-release button pressed halfway (①), press the ^{AE-L}_{AF-L} **AE-L/AF-L** button (②) to lock focus. Focus will remain locked while the ^{AE-L}_{AF-L} **AE-L/AF-L** button is pressed, even if you later remove your finger from the shutter-release button.



AF-S (viewfinder photography) and live view: Focus locks automatically and remain locked until you remove your finger from the shutter-release button. Focus can also be locked by pressing the ^{AE-L}_{AF-L} **AE-L/AF-L** button (see above).

3 Recompose the photograph and shoot.

Focus will remain locked between shots if you keep the shutter-release button pressed halfway (**AF-S** and live view) or keep the AE-L/AF-L **AE-L/AF-L** button pressed, allowing several photographs in succession to be taken at the same focus setting.



Viewfinder photography



Live view

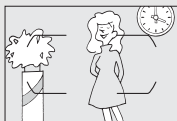
Do not change the distance between the camera and the subject while focus lock is in effect. If the subject moves, focus again at the new distance.

See Also

Pressing the AE-L/AF-L **AE-L/AF-L** button in Step 2 also locks exposure (□ 107). See Custom Setting f4 (**Assign AE-L/AF-L button**, □ 285) for information on choosing the role played by the AE-L/AF-L **AE-L/AF-L** button.

Getting Good Results with Autofocus

Autofocus does not perform well under the conditions listed below. The shutter release may be disabled if the camera is unable to focus under these conditions, or the in-focus indicator (●) may be displayed and the camera may sound a beep, allowing the shutter to be released even when the subject is not in focus. In these cases, focus manually (☐ 97) or use focus lock (☐ 93) to focus on another subject at the same distance and then recompose the photograph.



There is little or no contrast between the subject and the background.

Example: Subject is the same color as the background.



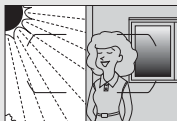
The focus point contains objects at different distances from the camera.

Example: Subject is inside a cage.



The subject is dominated by regular geometric patterns.

Example: Blinds or a row of windows in a skyscraper.



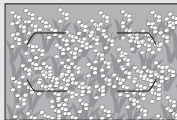
The focus point contains areas of sharply contrasting brightness.

Example: Subject is half in the shade.



Background objects appear larger than the subject.

Example: A building is in the frame behind the subject.



The subject contains many fine details.

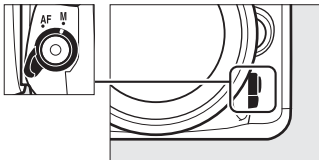
Example: A field of flowers or other subjects that are small or lack variation in brightness.

Manual Focus

Manual focus is available for lenses that do not support autofocus (non-AF NIKKOR lenses) or when the autofocus does not produce the desired results (📖 96).

- **AF lenses:** Set the lens focus mode switch (if present) and camera focus-mode selector to **M**.

Focus-mode selector

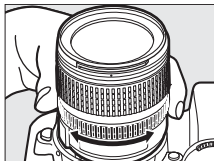


✓ AF Lenses

Do not use AF lenses with the lens focus mode switch set to **M** and the camera focus-mode selector set to **AF**. Failure to observe this precaution could damage the camera or lens. This does not apply to AF-S lenses, which can be used in **M** mode without setting the camera focus-mode selector to **M**.

- **Manual focus lenses:** Focus manually.

To focus manually, adjust the lens focus ring until the subject is in focus. Photographs can be taken at any time, even when the image is not in focus.



■ The Electronic Rangefinder (Viewfinder Photography)

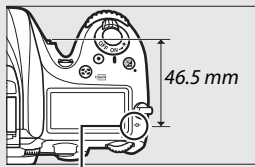
The viewfinder focus indicator can be used to confirm whether the subject in the selected focus point is in focus (the focus point can be selected from any of the 51 focus points). After positioning the subject in the selected focus point, press the shutter-release button halfway



and rotate the lens focus ring until the in-focus indicator (●) is displayed. Note that with the subjects listed on page 96, the in-focus indicator may sometimes be displayed when the subject is not in focus; confirm focus in the viewfinder before shooting. For information on using the electronic rangefinder with optional AF-S/AF-I teleconverters, see page 307.



■ Focal Plane Position

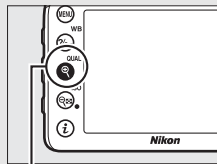
To determine the distance between your subject and the camera, measure from the focal plane mark (⊖) on the camera body. The distance between the lens mounting flange and the focal plane is 46.5 mm (1.83 in.).



Focal plane mark

■ Live View


Press the  (QUAL) button to zoom in for precise focus in live view ( 38).




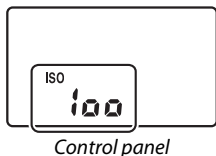
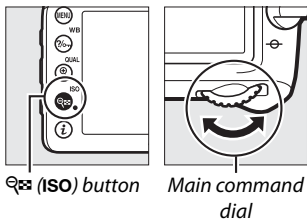
 (QUAL) button

ISO Sensitivity

The camera's sensitivity to light can be adjusted according to the amount of light available. Choose from settings that range from ISO 100 to ISO 25600 in steps equivalent to $\frac{1}{3}$ EV. Auto, scene, and special effect modes also offer an **AUTO** option, which allows the camera to set ISO sensitivity automatically in response to lighting conditions. Settings of Hi BW1 (equivalent to ISO 51200) and Hi BW2 (equivalent to ISO 102400) are also available, but note that pictures taken with either setting are recorded in monochrome using the options selected for **Set Picture Control > Monochrome** in the photo shooting menu (☞ 130). The higher the ISO sensitivity, the less light needed to make an exposure, allowing higher shutter speeds or smaller apertures.

Modes	Options
P, S, A, M	100–25600; Hi BW1 and Hi BW2
	Auto
Other shooting modes	Auto; 100–25600

ISO sensitivity can be adjusted by pressing the  (ISO) button and rotating the main command dial until the desired setting is displayed.



The Photo Shooting Menu

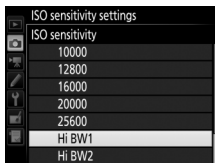
ISO sensitivity can also be adjusted from the photo shooting menu. Choose **ISO sensitivity settings** in photo shooting menu to adjust settings for photographs (□ 271).

Live View

In live view, the selected value is displayed in the monitor.

■ Hi BW1/Hi BW2

In **P**, **S**, **A**, and **M** modes, Hi BW1 and Hi BW2 can be selected using the **ISO sensitivity settings** (☞ 271) > **ISO sensitivity** option in the photo shooting menu.



✔ Hi ISO Command Dial Access

If **On** is chosen for **ISO sensitivity settings** > **Hi ISO command dial access** (☞ 271), Hi BW1 and Hi BW2 can be selected by pressing the **ISO** button and rotating the main command dial. If **Off** is chosen for **Hi ISO command dial access** while Hi BW1 or Hi BW2 is selected, rotating the main command dial will have no effect, but ISO sensitivity can still be adjusted from the menus.

✔ Restrictions on Hi BW1 and Hi BW2

Note the following restrictions when using Hi BW1 or Hi BW2:

- Image quality and size can not be changed when Hi BW1 or Hi BW2 is selected. Pictures shot with **NEF (RAW)** selected for image quality are recorded in fine-quality JPEG format. If an **NEF (RAW) + JPEG** option is selected, only the JPEG image will be recorded.
- Auto ISO sensitivity control (☞ 102), Active D-Lighting (☞ 139), HDR (☞ 141), multiple exposure (☞ 211), and time-lapse photography (☞ 171) are not available.

✔ See Also

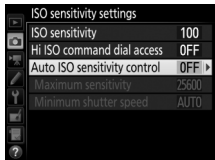
For information on choosing the ISO sensitivity step size, see Custom Setting b1 (**ISO sensitivity step value**; ☞ 278). For information on adjusting ISO sensitivity without using the **ISO** button, see Custom Setting d8 (**Easy ISO**; ☞ 281). For information on using the **High ISO NR** option in the shooting menus to reduce noise at high ISO sensitivities, see pages 271 and 275.

Auto ISO Sensitivity Control

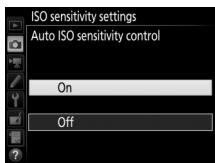
(P, S, A, and M Modes Only)

If **On** is selected for **ISO sensitivity settings** > **Auto ISO sensitivity control** in the photo shooting menu, ISO sensitivity will automatically be adjusted if optimal exposure can not be achieved at the value selected by the user (ISO sensitivity is adjusted appropriately when the flash is used).

- 1 Select Auto ISO sensitivity control.**
Select **ISO sensitivity settings** in the photo shooting menu, highlight **Auto ISO sensitivity control** and press \odot .



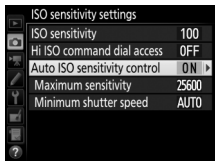
- 2 Select On.**
Highlight **On** and press \odot (if **Off** is selected, ISO sensitivity will remain fixed at the value selected by the user).



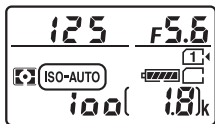
3 Adjust settings.

The maximum value for auto ISO sensitivity can be selected using **Maximum sensitivity** (note that if the ISO sensitivity selected by the user is higher than that chosen for

Maximum sensitivity, the value selected by the user will be used instead). In modes **P** and **A**, sensitivity will only be adjusted if underexposure would result at the shutter speed selected for **Minimum shutter speed** ($1/4000$ –30 s, or **Auto**; in modes **S** and **M**, ISO sensitivity will be adjusted for optimal exposure at the shutter speed selected by the user). If **Auto** is selected, the camera will choose the minimum shutter speed based on the focal length of the lens. Press **OK** to exit when settings are complete.




ISO AUTO is displayed when **On** is selected. When sensitivity is altered from the value selected by the user, these indicators flash and the altered value is shown in the control panel.





Live View

In live view, the auto ISO sensitivity control indicator is displayed in the monitor.


Minimum Shutter Speed

Auto shutter-speed selection can be fine-tuned by highlighting **Auto** and pressing : for example, values faster than those usually selected automatically can be used with telephoto lenses to reduce blur. Note, however, that **Auto** functions only with CPU lenses; if a non-CPU lens is used without lens data, minimum shutter speed is fixed at $\frac{1}{30}$ s. Shutter speeds may drop below the selected minimum if optimum exposure can not be achieved at the ISO sensitivity chosen for **Maximum sensitivity**.

Auto ISO Sensitivity Control

When a flash is used, minimum shutter speed will be set to the value selected for **Minimum shutter speed** unless this value is faster than Custom Setting e1 (**Flash sync speed**,  282) or slower than Custom Setting e2 (**Flash shutter speed**,  283), in which case the value selected for Custom Setting e2 will be used instead. Note that ISO sensitivity may be raised automatically when auto ISO sensitivity control is used in combination with slow sync flash modes (available with the built-in flash and the optional flash units listed on page 311), possibly preventing the camera from selecting slow shutter speeds.

Enabling and Disabling Auto ISO Sensitivity Control




You can turn auto ISO sensitivity control on or off by pressing the  (**ISO**) button and rotating the sub-command dial. **ISO AUTO** is displayed when auto ISO sensitivity control is on.


Exposure

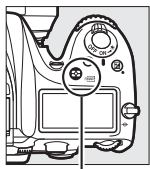
Metering


(P, S, A, and M Modes Only)

Choose how the camera sets exposure in **P**, **S**, **A**, and **M** modes (in other modes, the camera selects the metering method automatically).

Option	Description
	Matrix: Produces natural results in most situations. Camera meters a wide area of the frame and set exposure according to tone distribution, color, composition, and, with type G, E, or D lenses (□ 307), distance information (3D color matrix metering II; with other CPU lenses, camera uses color matrix metering II, which does not include 3D distance information).
	Center-weighted: Camera meters entire frame but assigns greatest weight to center area (if CPU lens is attached, size of area for viewfinder photography can be selected using Custom Setting b4, Center-weighted area , □ 278; if non-CPU lens is attached, area is equivalent to circle 8 mm in diameter). Classic meter for portraits; recommended when using filters with an exposure factor (filter factor) over 1×.
	Spot: Camera meters circle centered on current focus point, making it possible to meter off-center subjects (if non-CPU lens is used or if auto-area AF is in effect, camera will meter center focus point). Diameter of circle for viewfinder photography is 3.5 mm (0.14 in.), or approximately 2.5% of frame. Ensures that subject will be correctly exposed, even when background is much brighter or darker.

To choose a metering option, press the  (**FORMAT**) button and rotate the main command dial until the desired setting is displayed.



 (**FORMAT**) button



Main command dial




Control panel


Live View

In live view, the selected option is displayed in the monitor.

Non-CPU Lens Data

Specifying the focal length and maximum aperture of non-CPU lenses using the **Non-CPU lens data** option in the setup menu ( 225) allows the camera to use color matrix metering when matrix is selected. Center-weighted metering will be used if matrix metering is selected with non-CPU lenses for which lens data have not been supplied.

See Also

For information on making separate adjustments to optimal exposure for each metering method, see Custom Setting b5 (**Fine-tune optimal exposure**,  278).

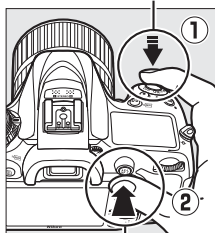
Autoexposure Lock

Use autoexposure lock to recompose photographs after using center-weighted metering and spot metering (📖 105) to meter exposure.

1 Lock exposure.

Position the subject in the selected focus point and press the shutter-release button halfway. With the shutter-release button pressed halfway and the subject positioned in the focus point, press the $\overset{\text{AE-L}}{\text{AF-L}}$ **AE-L/AF-L** button to lock focus and exposure (if you are using autofocus, confirm that the camera is in focus; 📖 34).

Shutter-release button



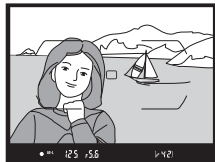
$\overset{\text{AE-L}}{\text{AF-L}}$ **AE-L/AF-L** button

While exposure lock is in effect, an **AE-L** indicator will appear in the viewfinder and the monitor.



2 Recompose the photograph.

Keeping the $\overset{\text{AE-L}}{\text{AF-L}}$ **AE-L/AF-L** button pressed, recompose the photograph and shoot.



Spot Metering

In spot metering, exposure will be locked at the value metered at the selected focus point (□ 105).


Adjusting Shutter Speed and Aperture

While exposure lock is in effect, the following settings can be adjusted without altering the metered value for exposure:


Mode	Setting
P	Shutter speed and aperture (flexible program; □ 52)
S	Shutter speed
A	Aperture


Note that metering can not be changed while exposure lock is in effect.

See Also

If **On** is selected for Custom Setting c1 (**Shutter-release button AE-L**, □ 279), exposure will lock when the shutter-release button is pressed halfway. For information on changing the role of the  **AE-L/AF-L** button, see Custom Setting f4 (**Assign AE-L/AF-L button**, □ 285).

Exposure Compensation

(P, S, A, M, SCENE, and  Modes Only)

Exposure compensation is used to alter exposure from the value suggested by the camera, making pictures brighter or darker. It is most effective when used with center-weighted or spot metering ( 105). Choose from values between -5 EV (underexposure) and $+5$ EV (overexposure) in increments of $\frac{1}{3}$ EV. In general, positive values make the subject brighter while negative values make it darker.




-1 EV

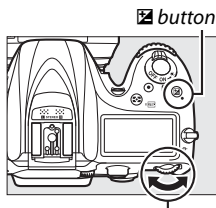


No exposure
compensation



$+1$ EV

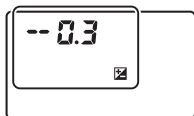
To choose a value for exposure compensation, press the  button and rotate the main command dial until the desired value is displayed.



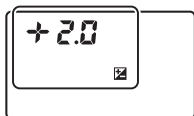
Main command dial






± 0 EV

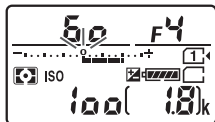


-0.3 ($-\frac{1}{3}$) EV



$+2.0$ EV

At values other than ± 0.0 , the 0 at the center of the exposure indicators will flash (modes **P**, **S**, **A**, **SCENE**, and **AE-L/AF-ON**) and a  icon will be displayed in the control panel and viewfinder after you release the  button. The current value for exposure compensation can be confirmed in the exposure indicator by pressing the  button.




Normal exposure can be restored by setting exposure compensation to ± 0 . Except in **SCENE** and **AE-L/AF-ON** modes, exposure compensation is not reset when the camera is turned off (in **SCENE** and **AE-L/AF-ON** modes, exposure compensation will be reset when another mode is selected or the camera is turned off).





Mode M

In mode **M**, exposure compensation affects only the exposure indicator; shutter speed and aperture do not change.

Exposure Compensation (Live View)

When the live view selector is rotated to , exposure compensation can be set to values between -5 and $+5$ EV, but only values between -3 and $+3$ can be previewed in the monitor.








See Also

For information on choosing the size of the increments available for exposure compensation, see Custom Setting b2 (**EV steps for exposure cntrl**,  278). For information on making adjustments to exposure compensation without pressing the  button, see Custom Setting b3 (**Easy exposure compensation**,  278). For information on restricting the effects of exposure compensation to the background when using a flash for foreground lighting, see Custom Setting e4 (**Exposure comp. for flash**,  283). For information on automatically varying exposure, flash level, white balance, or Active D-Lighting, see page 197.


White Balance

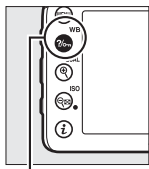
(P, S, A, and M Modes Only)


White balance ensures that colors are unaffected by the color of the light source. In modes other than **P**, **S**, **A**, and **M**, white balance is set automatically by the camera. Auto white balance is recommended for most light sources in **P**, **S**, **A**, and **M** modes, but other values can be selected if necessary according to the type of source:

	Option	Color temp.*
AUTO	Auto	3500–8000 K
	Normal	
	Keep warm lighting colors	
	Incandescent	3000 K
	Fluorescent	
	Sodium-vapor lamps	2700 K
	Warm-white fluorescent	3000 K
	White fluorescent	3700 K
	Cool-white fluorescent	4200 K
	Day white fluorescent	5000 K
	Daylight fluorescent	6500 K
	High temp. mercury-vapor	7200 K
	Direct sunlight	5200 K
	Flash	5400 K
	Cloudy	6000 K
	Shade	8000 K
	Choose color temp. (☐ 117)	2500–10,000 K
PRE	Preset manual (☐ 120)	—

* All values are approximate and do not reflect fine-tuning (if applicable).

White balance is set by pressing the  (**WB**) button and rotating the main command dial until the desired setting is displayed.



 (**WB**) button



Main command dial




Information display

Live View

In live view, the selected option is displayed in the monitor.

The Shooting Menus

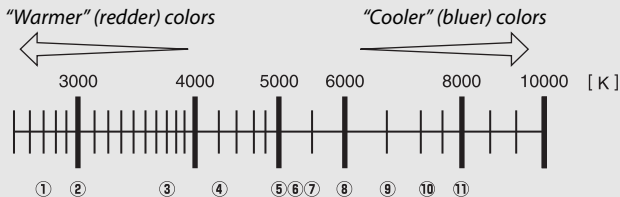
White balance can also be adjusted using the **White balance** option in either of the shooting menus (□ 269, 274), which also can be used to fine-tune white balance (□ 114) or measure a value for preset manual white balance (□ 120). The **Auto** option in the **White balance** menu offers a choice of **Normal** and **Keep warm lighting colors**, which preserves the warm colors produced by incandescent lighting, while the  **Fluorescent** option can be used to select the light source from the bulb types. The item in the movie shooting menu offers a **Same as photo settings** option that sets the white balance for movies to the same as that used for photographs.













Studio Flash Lighting

Auto white balance may not produce the desired results with large studio flash units. Use preset manual white balance or set white balance to **Flash** and use fine tuning to adjust white balance.

Color Temperature

The perceived color of a light source varies with the viewer and other conditions. Color temperature is an objective measure of the color of a light source, defined with reference to the temperature to which an object would have to be heated to radiate light in the same wavelengths. While light sources with a color temperature in the neighborhood of 5000–5500 K appear white, light sources with a lower color temperature, such as incandescent light bulbs, appear slightly yellow or red. Light sources with a higher color temperature appear tinged with blue.



- | | |
|---|---|
| ① |  (sodium-vapor lamps): 2700 K |
| ② |  (incandescent)/  (warm-white fluorescent.): 3000 K |
| ③ |  (white fluorescent): 3700 K |
| ④ |  (cool-white fluorescent): 4200 K |
| ⑤ |  (day white fluorescent): 5000 K |
| ⑥ |  (direct sunlight): 5200 K |
| ⑦ |  (flash): 5400 K |
| ⑧ |  (cloudy): 6000 K |
| ⑨ |  (daylight fluorescent): 6500 K |
| ⑩ |  (high temp. mercury-vapor): 7200 K |
| ⑪ |  (shade): 8000 K |

Note: All figures are approximate.

Fine-Tuning White Balance

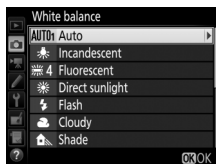
At settings other than **☑ (Choose color temp.)**, white balance can be “fine-tuned” to compensate for variations in the color of the light source or to introduce a deliberate color cast into an image.

■ The White Balance Menu

To fine-tune white balance from the shooting menus, select **White balance** and follow the steps below.

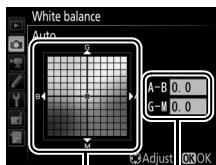
1 Display fine-tuning options.

Highlight a white balance option and press **⏏** (if a sub-menu is displayed, select the desired option and press **⏏** again to display fine-tuning options; for information on fine-tuning preset manual white balance, see page 129).



2 Fine tune white balance.

Use the multi selector to fine-tune white balance. White balance can be fine-tuned on the amber (A)–blue (B) axis in steps of 0.5 and the green (G)–magenta (M) axis in steps of 0.25. The horizontal (amber–blue) axis corresponds to color temperature, while the vertical (green–magenta) axis has the similar effects to the corresponding color compensation (CC) filters. The horizontal axis is ruled in increments equivalent to about 5 mired, the vertical axis in increments of about 0.05 diffuse density units.



3 Press **OK**.

Press **OK** to save settings and return to the shooting menus.

■ ■ **The $\frac{?}{\circ} \text{ (WB)}$ Button**

At settings other than **K**

(Choose color temp.) and **PRE**

(Preset manual), the $\frac{?}{\circ} \text{ (WB)}$

button can be used to fine-tune

white balance on the amber

(A)–blue (B) axis (114; to fine-

tune white balance when **PRE** is

selected, use the shooting

menus as described on page

129). Press the $\frac{?}{\circ} \text{ (WB)}$ button and rotate the sub-command

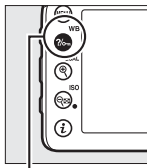
dial to fine-tune white balance in steps of 0.5 (with each full

increment equivalent to about 5 mired) until the desired value is

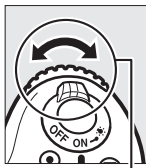
displayed. Rotating the sub-command dial to the left increases

the amount of amber (A). Rotating the sub-command dial to the

right increases the amount of blue (B).



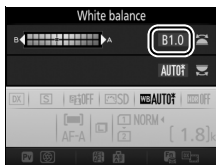
$\frac{?}{\circ} \text{ (WB)}$ button



Sub-command dial



Control panel




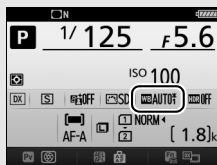
Information display

■ **Live View**

In live view, the selected value is displayed in the monitor.

White Balance Fine-Tuning

If white balance has been fine-tuned, an asterisk (“*”) will be displayed next to the white balance setting. Note that the colors on the fine-tuning axes are relative, not absolute. For example, moving the cursor to **B** (blue) when a “warm” setting such as  (incandescent) is selected for white balance will make photographs slightly “colder” but will not actually make them blue.



Information display





Shooting display

“Mired”

Any given change in color temperature produces a greater difference in color at low color temperatures than it would at higher color temperatures. For example, a change of 1000 K produces a much greater change in color at 3000 K than at 6000 K. Mired, calculated by multiplying the inverse of the color temperature by 10^6 , is a measure of color temperature that takes such variation into account, and as such is the unit used in color-temperature compensation filters. E.g.:

- 4000 K–3000 K (a difference of 1000 K)=83 mired
- 7000 K–6000 K (a difference of 1000 K)=24 mired

See Also

When **WB bracketing** is selected for Custom Setting e6 (**Auto bracketing set**,  284), the camera will create several images each time the shutter is released. White balance will be varied with each image, “bracketing” the value currently selected for white balance ( 202).

Choosing a Color Temperature

Follow the steps below to choose a color temperature when **K** (Choose color temp.) is selected for white balance.

☑ Choose Color Temperature

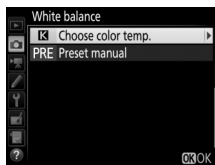
Note that the desired results will not be obtained with flash or fluorescent lighting. Choose **⚡** (Flash) or **☀** (Fluorescent) for these sources. With other light sources, take a test shot to determine if the selected value is appropriate.

■ The White Balance Menu

Color temperature can be selected using the **White balance** options in the shooting menus. Enter values for the amber–blue and green–magenta axes (📖 114) as described below.

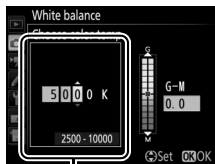
1 Select Choose color temp.

Select **White balance** in either of the shooting menus, then highlight **Choose color temp.** and press **⏏**.



2 Select a value for amber-blue.

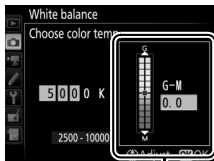
Press **⏏** or **⏏** to highlight digits and press **⏏** or **⏏** to change.



Value for amber (A)-
blue (B) axis

3 Select a value for green-magenta.

Press or to highlight the G (green) or M (magenta) axis and press or to select a value.



*Value for green (G)-
magenta (M) axis*

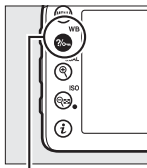
4 Press .

Press to save changes and return to the shooting menu. If a value other than 0 is selected for the green (G)-magenta (M) axis, an asterisk ("*****") will be displayed next to the icon.



■ The ?/0 (WB) Button

When K (Choose color temp.) is selected, the ?/0 (WB) button can be used to select the color temperature, although only for the amber (A)–blue (B) axis. Press the ?/0 (WB) button and rotate the sub-command dial until the desired value is displayed (adjustments are made in mireds; \square 116). To enter a color temperature directly, press the ?/0 (WB) button and press 0 or 1 to highlight a digit and press 0 or 1 to change.



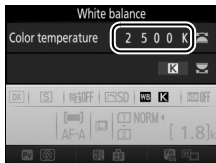
?/0 (WB) button



Sub-command dial



Control panel





Information display

Live View

In live view, the selected value is displayed in the monitor.

Preset Manual


Preset manual is used to record and recall custom white balance settings for shooting under mixed lighting or to compensate for light sources with a strong color cast. The camera can store up to six values for preset manual white balance in presets d-1 through d-6. Two methods are available for setting preset manual white balance:

Method	Description
Direct measurement	Neutral gray or white object is placed under lighting that will be used in final photo and white balance measured by camera. In live view, white balance can be measured in a selected area of the frame (spot white balance,  124).
Copy from existing photograph	White balance is copied from photo on memory card ( 127).

Viewfinder Photography

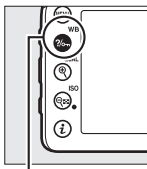
1

Light a reference object.

Place a neutral gray or white object under the lighting that will be used in the final photograph. In studio settings, a standard gray panel can be used as a reference object. Note that exposure is automatically increased by 1 EV when measuring white balance; in mode **M**, adjust exposure so that the exposure indicator shows ± 0 ( 57).

2 Set white balance to PRE (Preset manual).

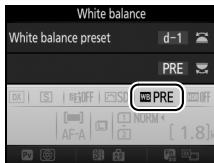
Press the **WB** button and rotate the main command dial until **PRE** is displayed in the information display.



WB button



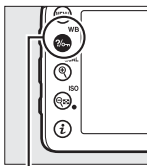
Main command dial



Information display

3 Select a preset.

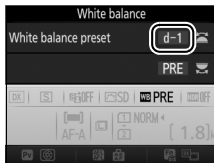
Press the **WB** button and rotate the sub-command dial until the desired white balance preset (d-1 to d-6) is displayed in the information display.



WB button




Sub-command dial



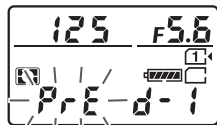
Information display

Measuring Preset Manual White Balance (Viewfinder Photography)

Preset manual white balance can not be measured while you are shooting an HDR photograph (141) or multiple exposure (211), or when **Record movies** is selected for Custom Setting g4 (**Assign shutter button**, 288) and the live view selector is rotated to .

4 Select direct measurement mode.

Release the **WB** button briefly and then press the button until **P-r-E** starts to flash in the control panel and viewfinder.



Control panel



Viewfinder

5 Measure white balance.

In the few seconds before the indicators stop flashing, frame the reference object so that it fills the viewfinder and press the shutter-release button all the way down. The camera will measure a value for white balance and store it in the preset selected in Step 3. No photograph will be recorded; white balance can be measured accurately even when the camera is not in focus.



Protected Presets

If the current preset is protected (☐ 129), **P-r-E** or **Prt** will flash in the control panel, viewfinder, and information display if you attempt to measure a new value.

6 Check the results.

If the camera was able to measure a value for white balance, **Good** will flash in the control panel, while the viewfinder will show a flashing **Gd**. Press the shutter-release button halfway to exit to shooting mode.

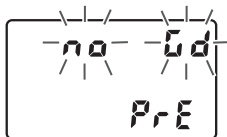


Control panel



Viewfinder

If lighting is too dark or too bright, the camera may be unable to measure white balance. A flashing **noGd** will appear in the control panel and viewfinder. Press the shutter-release button halfway to return to Step 5 and measure white balance again.



Control panel



Viewfinder

Direct Measurement Mode

If no operations are performed during viewfinder photography while the displays are flashing, direct measurement mode will end in the time selected for Custom Setting c2 (**Standby timer**, 279).

Selecting a Preset

Selecting **Preset manual** for the **White balance** option in either of the shooting menus displays the dialog shown at right; highlight a preset and press **OK**. If no value currently exists for the selected preset, white balance will be set to 5200 K, the same as **Direct sunlight**.

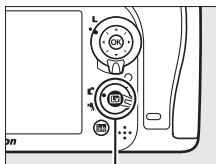


Live View (Spot White Balance)

During live view, white balance can be measured directly from any white or gray object in the frame.

1 Press the **[Lv]** button.

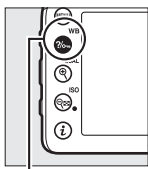
The mirror will be raised and the view through the lens will be displayed in the camera monitor.



[Lv] button

2 Set white balance to PRE (Preset manual).

Press the **[WB]** button and rotate the main command dial until **PRE** is displayed in the monitor.



[WB] button



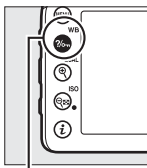
Main command dial



Monitor

3 Select a preset.

Press the **WB** button and rotate the sub-command dial until the desired white balance preset (d-1 to d-6) is displayed in the monitor.



WB button



Sub-command dial



Monitor

4 Select direct measurement mode.

Release the **WB** button briefly and then press the button until the **PRE** icon in the monitor starts to flash. A spot white balance target (□) will be displayed at the selected focus point.



Monitor

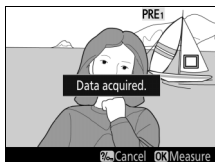
5 Position the target over a white or grey area.

While **PRE** flashes in the display, use the multi selector to position the □ over a white or grey area of the subject. To zoom the area around the target in for more precise positioning, press the **QUAL** button.

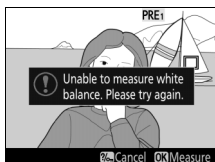


6 Measure white balance.

Press **OK** or press the shutter-release button all the way down to measure white balance. The time available to measure white balance is that selected for Custom Setting c4 (**Monitor off delay**) > **Live view** (□ 279).



If the camera is unable to measure white balance, the message shown at right will be displayed. Choose a new white balance target and repeat the process from Step 5.



7 Exit direct measurement mode.

Press the **WB** button to exit direct measurement mode.

When **Preset manual** is selected for **White balance** in either of the shooting menus, the position of the target used to measure preset manual white balance will be displayed on presets recorded during live view.



Measuring Preset Manual White Balance (Live View)

Preset manual white balance can not be measured when **Record movies** is selected for Custom Setting g4 (**Assign shutter button**, □ 288) and the live view selector is rotated to **Movie**. Preset manual white balance can not be set while an HDR exposure is in progress (□ 141).

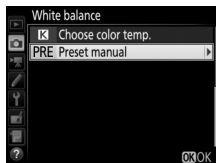
Managing Presets

■ Copying White Balance from a Photograph

Follow the steps below to copy a value for white balance from an existing photograph to a selected preset.

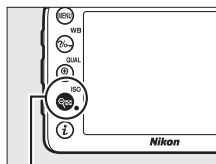
1 Select **Preset manual**.

Select **White balance** in either of the shooting menus, then highlight **Preset manual** and press **OK**.



2 Select a destination.

Highlight the destination preset (d-1 to d-6) and press **ISO**.

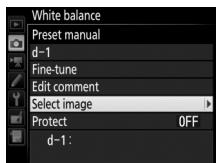


ISO button

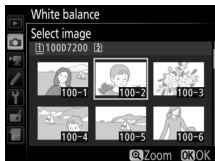


3 Choose **Select image**.

Highlight **Select image** and press **OK**.



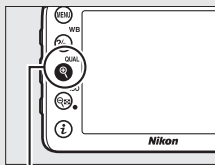
- 4 Highlight a source image.**
Highlight the source image.



- 5 Copy white balance.**
Press **OK** to copy the white balance value for the highlighted photograph to the selected preset. If the highlighted photograph has a comment (📖 291), the comment will be copied to the comment for the selected preset.

Choosing a Source Image

To view the image highlighted in Step 4 full frame, press and hold the **QUAL** button.

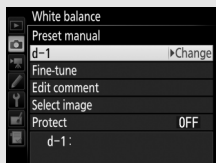


QUAL button



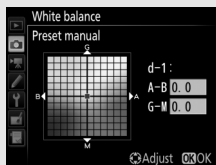
✎ Choosing a White Balance Preset

Press to highlight the current white balance preset (d-1–d-6) and press to select another preset.



✎ Fine-Tuning Preset Manual White Balance

The selected preset can be fine-tuned by selecting **Fine-tune** and adjusting white balance as described on page 114.



✎ Edit Comment

To enter a descriptive comment of up to 36 characters for the current white-balance preset, select **Edit comment** in the preset manual white balance menu and enter a comment as described on page 136.



✎ Protect

To protect the current white-balance preset, select **Protect** in the preset manual white balance menu, then highlight **On** and press . Protected presets can not be modified and the **Fine-tune** and **Edit comment** options can not be used.

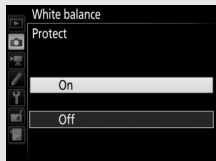


Image Enhancement








Picture Controls

(P, S, A, and M Modes Only)

In **P**, **S**, **A**, and **M** modes, your choice of Picture Control determines how pictures are processed (in other modes, the camera selects a Picture Control automatically).

Selecting a Picture Control


Choose a Picture Control according to the subject or type of scene.

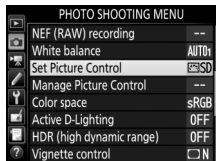
Option	Description
 SD Standard	Standard processing for balanced results. Recommended for most situations.
 NL Neutral	Minimal processing for natural results. Choose for photographs that will later be processed or retouched.
 VI Vivid	Pictures are enhanced for a vivid, photoprint effect. Choose for photographs that emphasize primary colors.
 MC Monochrome	Take monochrome photographs.
 PT Portrait	Process portraits for skin with natural texture and a rounded feel.
 LS Landscape	Produces vibrant landscapes and cityscapes.
 FL Flat	Details are preserved over a wide tone range, from highlights to shadows. Choose for photographs that will later be extensively processed or retouched.

The Movie Shooting Menu


The **Set Picture Control** option in the movie shooting menu also offers a **Same as photo settings** option that sets the Picture Control for movies to the same as that used for photographs.

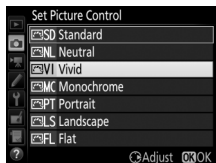
1 Select Set Picture Control.

Highlight **Set Picture Control** in either of the shooting menus and press .



2 Select a Picture Control.

Highlight a Picture Control and press .

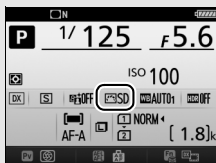


Custom Picture Controls

Custom Picture Controls are created through modifications to existing Picture Controls using the **Manage Picture Control** option in the shooting menus (135). Custom Picture Controls can be saved to a memory card for sharing among other cameras of the same model and compatible software (138).

The Picture Control Indicator

The current Picture Control is shown in the display.



Information display




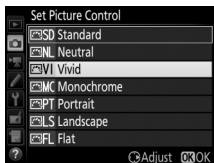
Shooting display

Modifying Picture Controls







Existing preset or custom Picture Controls (📖 135) can be modified to suit the scene or the user's creative intent. Choose a balanced combination of settings using **Quick adjust**, or make manual adjustments to individual settings.

1 Select a Picture Control.

Highlight the desired Picture Control in the Picture Control list (📖 130) and press .



2 Adjust settings.

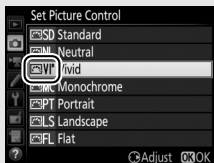
Press  or  to highlight the desired setting and press  or  to choose a value in increments of 1, or rotate the sub-command dial to choose a value in increments of 0.25 (📖 133). Repeat this step until all settings have been adjusted, or select a preset combination of settings by using the multi selector to choose **Quick adjust**. Default settings can be restored by pressing the  () button.



3 Press .

Modifications to Original Picture Controls

Picture Controls that have been modified from default settings are indicated by an asterisk ("*****").




Picture Control Settings

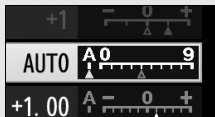
Option	Description	
Quick adjust	Mute or heighten the effect of the selected Picture Control (note that this resets all manual adjustments). Not available with Neutral, Monochrome, Flat , or custom Picture Controls (□ 135).	
Manual adjustments (all Picture Controls)	Sharpening	Control the sharpness of outlines. Select A to adjust sharpening automatically according to the type of scene.
	Clarity	Adjust clarity manually or select A to let the camera adjust clarity automatically. Depending on the scene, shadows may appear around bright objects or halos may appear around dark objects at some settings. Clarity is not applied to movies.
	Contrast	Adjust contrast manually or select A to let the camera adjust contrast automatically.
	Brightness	Raise or lower brightness without loss of detail in highlights or shadows.
Manual adjustments (non-monochrome only)	Saturation	Control the vividness of colors. Select A to adjust saturation automatically according to the type of scene.
	Hue	Adjust hue.
Manual adjustments (monochrome only)	Filter effects	Simulate the effect of color filters on monochrome photographs (□ 134).
	Toning	Choose the tint used in monochrome photographs (□ 135).

✔ "A" (Auto)

Results for auto sharpening, clarity, contrast, and saturation vary with exposure and the position of the subject in the frame. Use a type G, E, or D lens for best results.

✎ Switching Between Manual and Auto


Press the  (QUAL) button to switch back and forth between manual and auto (A) settings for sharpening, clarity, contrast, and saturation.



✎ Custom Picture Control Options

The options available with custom Picture Controls are the same as those on which the custom Picture Control was based.

✎ Previous Settings

The  indicator under the value display in the Picture Control setting menu indicates the previous value for the setting. Use this as a reference when adjusting settings.






✎ Filter Effects (Monochrome Only)

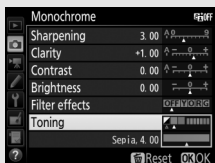
The options in this menu simulate the effect of color filters on monochrome photographs. The following filter effects are available:

Option	Description
Y Yellow	Enhances contrast. Can be used to tone down the brightness of the sky in landscape photographs.
O Orange	
R Red	Orange produces more contrast than yellow, red more contrast than orange.
G Green	Softens skin tones. Can be used for portraits.

Note that the effects achieved with **Filter effects** are more pronounced than those produced by physical glass filters.

Toning (Monochrome Only)


Pressing  when **Toning** is selected displays saturation options. Press  or  to adjust saturation. Saturation control is not available when **B&W** (black-and-white) is selected.

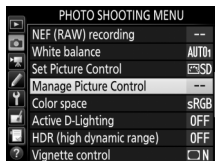


Creating Custom Picture Controls

The Picture Controls supplied with the camera can be modified and saved as custom Picture Controls.

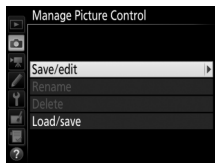
1 Select **Manage Picture Control**.

Highlight **Manage Picture Control** in either of the shooting menus and press .





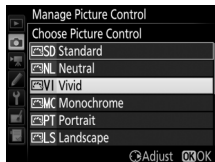
2 Select **Save/edit**.

Highlight **Save/edit** and press .





3 Select a Picture Control.

Highlight an existing Picture Control and press , or press  to proceed to Step 5 to save a copy of the highlighted Picture Control without further modification.




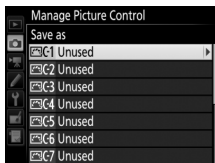
4 Edit the selected Picture Control.

See page 133 for more information. To abandon any changes and start over from default settings, press the  (FORMAT) button. Press  when settings are complete.








5 Select a destination.

Choose a destination for the custom Picture Control (C-1 through C-9) and press .



6 Name the Picture Control.

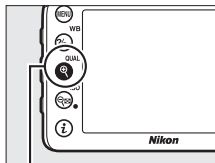
The text-entry dialog shown at right will be displayed. By default, new Picture Controls are named by adding a two-digit number (assigned automatically) to the name of the existing Picture Control; to use the default name, proceed to Step 7. To move the cursor in the name area, hold the  (ISO) button and press  or . To enter a new letter at the current cursor position, use the multi selector to highlight the desired character in the keyboard area and press . To delete the character at the current cursor position, press the  (FORMAT) button.



Custom Picture Control names can be up to nineteen characters long. Any characters after the nineteenth will be deleted.

7 Press **QUAL**.

Press the **QUAL** button to save changes and exit. The new Picture Control will appear in the Picture Control list.



QUAL button



Manage Picture Control > Rename

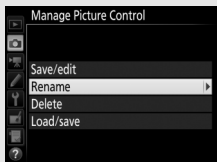
Custom Picture Controls can be renamed at any time using the **Rename** option in the **Manage Picture Control** menu.

Manage Picture Control > Delete

The **Delete** option in the **Manage Picture Control** menu can be used to delete selected custom Picture Controls when they are no longer needed.

The Original Picture Control Icon

The original preset Picture Control on which the custom Picture Control is based is indicated by an icon in the top right corner of the edit display.

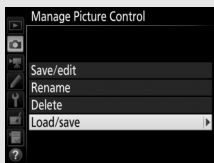


Original Picture Control icon



Sharing Custom Picture Controls

The **Load/save** item in the **Manage Picture Control** menu offers the options listed below. Use these options to copy custom Picture Controls to and from memory cards (these options are available only with the memory card in Slot 1 and can not be used with the card in Slot 2). Once copied to memory cards, Picture Controls can be used with other cameras or compatible software.



- **Copy to card:** Copy a custom Picture Control (C-1 through C-9) from the camera to a selected destination (1 through 99) on the memory card.
- **Copy to camera:** Copy custom Picture Controls from the memory card to custom Picture Controls C-1 through C-9 on the camera and name them as desired.
- **Delete from card:** Delete selected custom Picture Controls from the memory card.

Preserving Detail in Highlights and Shadows

(P, S, A, and M Modes Only)

Active D-Lighting

Active D-Lighting preserves details in highlights and shadows, creating photographs with natural contrast. Use for high contrast scenes, for example when photographing brightly lit outdoor scenery through a door or window or taking pictures of shaded subjects on a sunny day. It is most effective when used with matrix metering (☞ 105).



Active D-Lighting off




Active D-Lighting: 暗 A Auto

☑ “Active D-Lighting” Versus “D-Lighting”

The **Active D-Lighting** option in the photo shooting menu adjusts exposure before shooting to optimize the dynamic range, while the **D-Lighting** option in the retouch menu (☞ 294) brightens shadows in images after shooting.





To use Active D-Lighting:

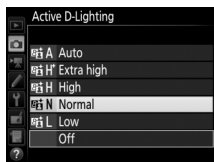
1 Select Active D-Lighting.

Highlight **Active D-Lighting** in the photo shooting menu and press .



2 Choose an option.



Highlight the desired option and press . If  **Auto** is selected, the camera will automatically adjust Active D-Lighting according to shooting conditions (in mode **M**, however,  **Auto** is equivalent to  **Normal**).



Active D-Lighting

With some subjects, you may notice uneven shading, shadows around bright objects, or halos around dark objects.

See Also

When **ADL bracketing** is selected for Custom Setting e6 (**Auto bracketing set**,  284), the camera varies Active D-Lighting over a series of shots ( 207). If desired, the **Fn** button and main command dial can be used to select Active D-Lighting; for more information, see Custom Setting f2 (**Assign Fn button**,  284).

High Dynamic Range (HDR)

Used with high-contrast subjects, **High Dynamic Range (HDR)** preserves details in highlights and shadows by combining two shots taken at different exposures. HDR is most effective when used with matrix metering (☐ 105; with spot or center-weighted metering and a non-CPU lens, a strength of **Auto** is equivalent to **Normal**). It can not be used to record NEF (RAW) images. Flash lighting, bracketing (☐ 197), multiple exposure (☐ 211), and time-lapse photography (☐ 171) can not be used while HDR is in effect and shutter speeds of **b u l b** and **- -** are not available.



First exposure (darker)

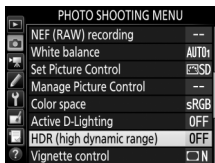


Second exposure (brighter)



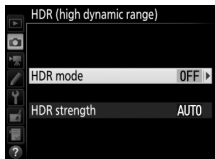
Combined HDR image


- Select HDR (high dynamic range).** Highlight **HDR (high dynamic range)** in the photo shooting menu and press **Q**.




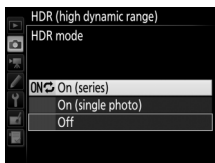
2 Select a mode.

Highlight **HDR mode** and press .



Highlight one of the following and press .

- **To take a series of HDR photographs**, select **ON  On (series)**. HDR shooting will continue until you select **Off** for **HDR mode**.
- **To take one HDR photograph**, select **On (single photo)**. Normal shooting will resume automatically after you have created a single HDR photograph.
- **To exit without creating additional HDR photographs**, select **Off**.





If **On (series)** or **On (single photo)** is selected, an **HDR** icon will be displayed in the viewfinder.

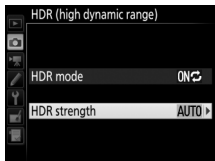


Viewfinder

3 Choose the HDR strength.

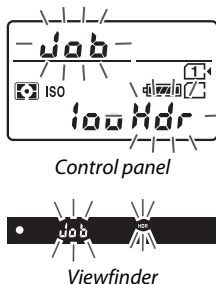
To choose the difference in exposure between the two shots (HDR strength), highlight **HDR strength** and press .

Highlight the desired option and press . If **Auto** is selected, the camera will automatically adjust HDR strength to suit the scene.



4 Frame a photograph, focus, and shoot.

The camera takes two exposures when the shutter-release button is pressed all the way down. **Job Hdr** will flash in the control panel and **Job HDR** in the viewfinder while the images are combined; no photographs can be taken until recording is complete. Regardless of the option currently selected for release mode, only one photograph will be taken each time the shutter-release button is pressed.



If **On (series)** is selected, HDR will only turn off when **Off** is selected for **HDR mode**; if **On (single photo)** is selected, HDR turns off automatically after the photograph is taken. The **HDR** icon clears from the display when HDR shooting ends.

✓ Framing HDR Photographs

The edges of the image will be cropped out. The desired results may not be achieved if the camera or subject moves during shooting. Use of a tripod is recommended. Depending on the scene, the effect may not be visible, shadows may appear around bright objects, or halos may appear around dark objects. Uneven shading may be visible with some subjects.

🔍 Interval Timer Photography







If **On (series)** is selected for **HDR mode** before interval timer shooting begins, the camera will continue to shoot HDR photographs at the selected interval (if **On (single photo)** is selected, interval timer shooting will end after a single shot).

Flash Photography



Using the Built-in Flash

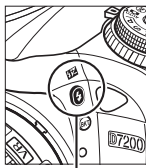
The built-in flash can be used not only when natural lighting is inadequate but to fill in shadows and backlit subjects or to add a catch light to the subject's eyes.



Auto Pop-up Modes

In , , , , , and  modes, the built-in flash automatically pops up and fires as required.

1 Choose a flash mode.

Keeping the  () button pressed, rotate the main command dial until the desired flash mode is displayed.



 () button



Main command dial



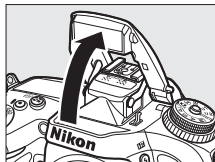
Information display

Live View

In live view, the selected option is displayed in the monitor.

2 Take pictures.

The flash will pop up as required when the shutter-release button is pressed halfway and fire when a photograph is taken. *If the flash does not pop up*




automatically, DO NOT attempt to raise it by hand. Failure to observe this precaution could damage the flash.


Flash Modes

The following flash modes are available:




Auto flash: When lighting is poor or the subject is backlit, the flash pops up automatically when the shutter-release button is pressed halfway and fires as required. Not available in  mode.




Auto with red-eye reduction: Use for portraits. The flash pops up and fires as required, but before it fires the red-eye reduction lamp lights to help reduce “red-eye.” Not available in  mode.



Auto slow sync with red-eye reduction: As for auto with red-eye reduction, except that slow shutter speeds are used to capture background lighting. Use for portraits taken at night or under low light. Available in  mode.



Auto slow sync: Slow shutter speeds are used to capture background lighting in shots taken at night or under low light. Available in  mode.




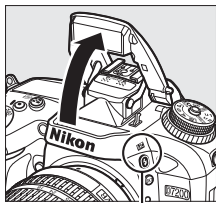
Off: The flash does not fire.


Manual Pop-up Modes

In **P**, **S**, **A**, **M**, and **11** modes, the flash must be raised manually. The flash will not fire if it is not raised.


1 Raise the flash.

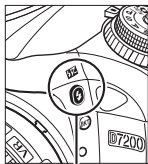
Press the  button to raise the flash. Note that if the flash is off or an optional external flash unit is attached, the built-in flash will not pop up; proceed to Step 2.




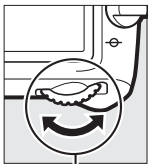
 button

2 Choose a flash mode (**P**, **S**, **A**, and **M** modes only).

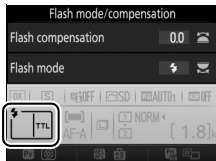
Keeping the  button pressed, rotate the main command dial until the desired flash mode is displayed.



 button




Main command dial



Information display

3 Take pictures.

If an option other than  is selected, the flash will fire whenever a picture is taken.

Live View

In live view, the selected option is displayed in the monitor.

Flash Modes

The following flash modes are available:



Fill flash: The flash fires with every shot.



Red-eye reduction: Use for portraits. The flash fires with every shot, but before it fires, the red-eye reduction lamp lights to help reduce “red-eye.” Not available in **ff** mode.



Red-eye reduction with slow sync: As for “red-eye reduction”, above, except that shutter speed slows automatically to capture background lighting at night or under low light. Use when you want to include background lighting in portraits. Not available in modes **S**, **M**, and **ff**.



Slow sync: As for “fill flash”, above, except that shutter speed slows automatically to capture background lighting at night or under low light. Use when you want to capture both subject and background. Not available in modes **S**, **M**, and **ff**.



Slow rear-curtain sync: As for “rear-curtain sync”, below, except that shutter speed slows automatically to capture background lighting at night or under low light. Use when you want to capture both subject and background. Not available in modes **S**, **M**, and **ff**. **SLOW** is displayed when setting is complete.

Rear-curtain sync: The flash fires just before the shutter closes, creating a stream of light behind moving light sources as shown below at right. Not available in modes **P**, **A**, and **ff**.



Front-curtain sync



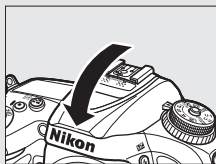
Rear-curtain sync



Off: The flash does not fire. Not available in **ff** mode.

✎ Lowering the Built-in Flash

To save power when the flash is not in use, press it gently downward until the latch clicks into place.



✔ The Built-in Flash

Remove lens hoods to prevent shadows. The flash has a minimum range of 0.6 m (2 ft) and can not be used in the macro range of zoom lenses with a macro function. i-TTL flash control is available at ISO sensitivities between 100 and 12800; at values over 12800, the desired results may not be achieved at some ranges or aperture values.

If the flash fires in continuous release modes (□ 66), only one picture will be taken each time the shutter-release button is pressed.

The shutter release may be briefly disabled to protect the flash after it has been used for several consecutive shots. The flash can be used again after a short pause.

✎ Shutter Speeds Available with the Built-in Flash

The following shutter speeds are available with the built-in flash.

Mode	Shutter speed
AUTO, , , , , , , , , , P* , A*	$\frac{1}{250}$ – $\frac{1}{60}$ s
	$\frac{1}{250}$ – $\frac{1}{30}$ s
	$\frac{1}{250}$ –1 s
S*	$\frac{1}{250}$ –30 s
M*	$\frac{1}{250}$ –30 s, b, u, l, b, - -

* Speeds as fast as $\frac{1}{8000}$ s are available with optional flash units that support auto FP high-speed sync when **1/320 s (Auto FP)** or **1/250 s (Auto FP)** is selected for Custom Setting e1 (**Flash sync speed**, □ 282). When **1/320 s (Auto FP)** is selected, shutter speeds as fast as $\frac{1}{320}$ s are available with the built-in flash.

Flash Control Mode

The camera supports the following i-TTL flash control modes:

- **i-TTL balanced fill-flash for digital SLR:** Flash emits series of nearly invisible preflashes (monitor preflashes) immediately before main flash. Preflashes reflected from objects in all areas of frame are picked up by 2016-pixel RGB sensor and are analyzed in combination with range information from matrix metering system to adjust flash output for natural balance between main subject and ambient background lighting. If type G, E, or D lens is used, distance information is included when calculating flash output. Precision of calculation can be increased for non-CPU lenses by providing lens data (focal length and maximum aperture; see page 224). Not available when spot metering is used.
- **Standard i-TTL fill-flash for digital SLR:** Flash output adjusted to bring lighting in frame to standard level; brightness of background is not taken into account. Recommended for shots in which main subject is emphasized at expense of background details, or when exposure compensation is used. Standard i-TTL fill-flash for digital SLR is activated automatically when spot metering is selected.

Metering

Select matrix or center-weighted metering to activate i-TTL balanced fill-flash for digital SLR. Standard i-TTL fill-flash for digital SLR is activated automatically when spot metering is selected.

Aperture, Sensitivity, and Flash Range

Flash range varies with sensitivity (ISO equivalency) and aperture.

Aperture at ISO equivalent of								Approximate range	
100	200	400	800	1600	3200	6400	12800	m	ft
1.4	2	2.8	4	5.6	8	11	16	0.7–8.5	2ft 4in.–27ft 10in.
2	2.8	4	5.6	8	11	16	22	0.6–6.0	2ft–19ft 8in.
2.8	4	5.6	8	11	16	22	32	0.6–4.2	2ft–13ft 9in.
4	5.6	8	11	16	22	32	—	0.6–3.0	2ft–9ft 10in.
5.6	8	11	16	22	32	—	—	0.6–2.1	2ft–6ft 10in.
8	11	16	22	32	—	—	—	0.6–1.5	2ft–4ft 11in.
11	16	22	32	—	—	—	—	0.6–1.1	2ft–3ft 7in.
16	22	32	—	—	—	—	—	0.6–0.8	2ft–2ft 7in.

The built-in flash has a minimum range of 0.6 m (2 ft).

In mode **P**, the maximum aperture (minimum f-number) is limited according to ISO sensitivity, as shown below:

Maximum aperture at ISO equivalent of:							
100	200	400	800	1600	3200	6400	12800
2.8	3.5	4	5	5.6	7.1	8	10

If the maximum aperture of the lens is smaller than given above, the maximum value for aperture will be the maximum aperture of the lens.

See Also


See page 153 for information on locking flash value (FV) for a metered subject before recomposing a photograph.

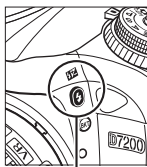
Menu options relevant to this section are listed below.


- **Custom Setting e1 (Flash sync speed):** Enable or disable auto FP high-speed sync and choose a flash sync speed (☐ 282)
- **Custom Setting e2 (Flash shutter speed):** Choose the slowest shutter speed available when using the flash (☐ 283)
- **Custom Setting e3 (Flash cntrl for built-in flash):** Choose a flash control mode (☐ 283)

Flash Compensation (P, S, A, M, and SCENE Modes Only)

Flash compensation is used to alter flash output by from -3 EV to $+1$ EV in increments of $\frac{1}{3}$ EV, changing the brightness of the main subject relative to the background. Flash output can be increased to make the main subject appear brighter, or reduced to prevent unwanted highlights or reflections.

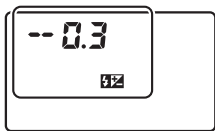
Press the  button and rotate the sub-command dial until the desired value is displayed. In general, choose positive values to make the main subject brighter, negative values to make it darker.



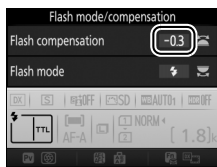
 button



Sub-command dial



Control panel



Information display



± 0 EV






-0.3 ($-\frac{1}{3}$) EV



$+1.0$ EV

Live View

In live view, the selected value is displayed in the monitor.



At values other than ± 0.0 , a  icon will be displayed after you release the  button. The current value for flash compensation can be confirmed by pressing the  button.

Normal flash output can be restored by setting flash compensation to ± 0.0 . Except in **SCENE** mode, flash compensation is not reset when the camera is turned off (in **SCENE** mode, flash compensation will be reset when another mode is selected or the camera is turned off).

Optional Flash Units

The flash compensation selected with the optional flash unit is added to the flash compensation selected with the camera.

See Also

For information on choosing the size of the increments available for flash compensation, see Custom Setting b2 (**EV steps for exposure cntrl**,  278). For information on choosing how flash and exposure compensation combine, see Custom Setting e4 (**Exposure comp. for flash**,  283). For information on automatically varying flash level over a series of shots, see page 197.

FV Lock




This feature is used to lock flash output, allowing photographs to be recomposed without changing the flash level and ensuring that flash output is appropriate to the subject even when the subject is not positioned in the center of the frame. Flash output is adjusted automatically for any changes in ISO sensitivity and aperture.

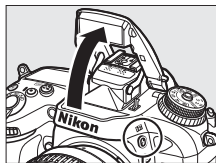
To use FV lock:


- 1 Assign FV lock to a camera control.**
Select **FV lock** as the “Press” option for Custom Setting f2 (**Assign Fn button**, [book 284](#)), f3 (**Assign preview button**, [book 285](#)), or f4 (**Assign AE-L/AF-L button**, [book 285](#)).



- 2 Raise the flash.**

In **P**, **S**, **A**, **M**, and **HL** modes, the flash can be raised by pressing the  button. In **AUTO**, , and  modes, the flash will pop up automatically when required.



 button

- 3 Focus.**

Position the subject in the center of the frame and press the shutter-release button halfway to focus.



4 Lock flash level.

After confirming that the flash-ready indicator (⚡) is displayed, press the button selected in Step 1. The flash will emit a monitor preflash to determine the appropriate flash level. Flash output will be locked at this level and an FV lock icon (🔒) will appear in the display.



5 Recompose the photograph.



6 Take the photograph.

Press the shutter-release button the rest of the way down to shoot. If desired, additional pictures can be taken without releasing FV lock.

7 Release FV lock.

Press the button selected in Step 1 to release FV lock. Confirm that the FV lock icon (🔒) is no longer displayed.

🔪 Using FV Lock with the Built-in Flash

FV lock is only available with the built-in flash when **TTL** is selected for Custom Setting e3 (**Flash cntrl for built-in flash**, 📄 283). Note that when commander mode is selected for Custom Setting e3, you will need to set the flash control mode for the master or at least one remote group to TTL or AA.

Metering


When FV lock is used with the built-in flash and no additional flash units, the camera meters a 4 mm circle in the center of the frame. When the built-in flash is used with optional flash units (Advanced Wireless Lighting), the camera meters the entire frame.

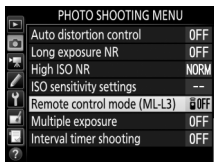
Remote Control Photography

Using an Optional ML-L3 Remote Control

The optional ML-L3 remote control (📖 319) can be used to reduce camera shake or for self-portraits.





1 Select Remote control mode (ML-L3).

Highlight **Remote control mode (ML-L3)** in the photo shooting menu and press .



2 Choose a remote control mode.

Highlight one of the following options and press .

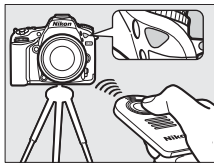
Option	Description
 2s Delayed remote	Shutter is released 2 s after ML-L3 shutter-release button is pressed.
 Quick-response remote	Shutter is released when ML-L3 shutter-release button is pressed.
 Remote mirror-up	Press ML-L3 shutter-release button once to raise mirror, again to release shutter and take photograph. Prevents blur caused by camera moving when mirror is raised.
 OFF	The shutter can not be released using the ML-L3.

3 Frame the photograph.

Mount the camera on a tripod or place the camera on a stable, level surface.

4 Take the photograph.

From a distance of 5 m (16 ft) or less, aim the transmitter on the ML-L3 at either of the infrared receivers on the camera (☞ 2, 4) and press the ML-L3 shutter-release button. *In delayed remote mode*, the self-timer lamp will light for about two seconds before the shutter is released. *In quick-response remote mode*, the self-timer lamp will flash after the shutter has been released. *In remote mirror-up mode*, pressing the ML-L3 shutter-release button once raises the mirror; the shutter will be released and the self-timer lamp will flash after 30 s or when the button is pressed a second time.




☑ Release Mode

When an optional ML-L3 remote control is used, the release mode selected with the release mode dial (☞ 66) is ignored in favor of the option selected for **Remote control mode (ML-L3)** in the photo shooting menu.

☑ Before Using Optional ML-L3 Remote Controls

Before using the remote control for the first time, remove the clear plastic battery-insulator sheet.

Using the Built-in Flash

Before taking a photograph with the flash in manual pop-up modes (☐ 146), press the  (🔌) button to raise the flash and wait for the flash-ready indicator (🔌) to be displayed (☐ 36). Shooting will be interrupted if the flash is raised while remote control mode is in effect. If the flash is required, the camera will only respond to the ML-L3 shutter-release button once the flash has charged. In auto pop-up modes (☐ 144), the flash will begin charging when remote control mode is selected; once the flash is charged, it will automatically pop up and fire when required.

In flash modes that support red-eye reduction, the red-eye reduction lamp will light for about one second before the shutter is released. In delayed remote mode, the self-timer lamp will light for two seconds, followed by the red-eye reduction lamp which lights for one second before the shutter is released.

Focusing in Remote Control Mode

The camera will not adjust focus continuously when continuous-servo autofocus is selected; note however that regardless of the autofocus mode selected, you can focus by pressing the camera shutter-release button halfway before shooting. If auto- or single-servo autofocus is selected or the camera is in live view in delayed or quick-response remote mode, the camera will automatically adjust focus before shooting; if the camera is unable to focus in viewfinder photography, it will return to stand-by without releasing the shutter.


Remote Mirror-up Mode

While the mirror is raised, photos can not be framed in the viewfinder and autofocus and metering will not be performed.

✎ Exiting Remote Control Mode

Remote control is cancelled automatically if no photograph is taken before the time selected for Custom Setting c5 (**Remote on duration (ML-L3)**, □ 279), **Off** is selected for **Remote control mode (ML-L3)**, a two-button reset is performed (□ 194), or shooting options are reset using **Reset photo shooting menu** (□ 268).

✎ Assign Shutter Button

If **Record movies** is selected for Custom Setting g4 (**Assign shutter button**, □ 288), the ML-L3 can not be used when the live view selector is rotated to .

✎ Cover the Viewfinder

To prevent light entering via the viewfinder from appearing in photographs or interfering with exposure, remove the rubber eyecup and cover the viewfinder with the supplied eyepiece cap (□ 70).

✎ See Also

For information on choosing the length of time the camera will remain in stand-by mode waiting for a signal from the remote control, see Custom Setting c5 (**Remote on duration (ML-L3)**; □ 279). For information on controlling the beeps that sound when the remote control is used, see Custom Setting d1 (**Beep**; □ 280).

Wireless Remote Controllers

When the camera is used with optional WR-1 and WR-R10/WR-T10 (☞ 319) wireless remote controllers, the shutter-release buttons on the WR-1 and WR-T10 perform the same functions as the camera shutter-release button, allowing remote continuous and self-timer photography.

WR-1 Wireless Remote Controllers

The WR-1 can function as either a transmitter or a receiver and is used in combination either with another WR-1 or a WR-R10 or WR-T10 wireless remote controller. For example, a WR-1 can be connected to the accessory terminal for use as a receiver, allowing camera settings to be changed or the shutter to be released remotely by another WR-1 acting as a transmitter.

WR-R10/WR-T10 Wireless Remote Controllers

When a WR-R10 (transceiver) is connected to the camera, the shutter can be released using a WR-T10 (transmitter).


Recording and Viewing Movies

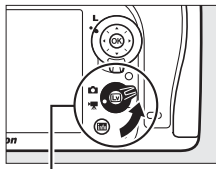
Recording Movies

Movies can be recorded in live view.

1 Rotate the live view selector to .

Aperture Selection (Modes A and M)

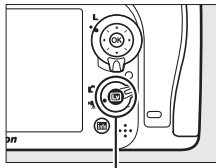
In modes A and M, choose an aperture before pressing the  button to start live view.



Live view selector


2 Press the button.

The mirror will be raised and the view through the lens will be displayed in the camera monitor as it would appear in the actual movie, modified for the effects of exposure. The subject will no longer be visible in the viewfinder.



Lv button

The Icon

A  icon ([p. 165](#)) indicates that movies can not be recorded.


3 Focus.

Frame the opening shot and focus (press the Q/QUAL button to zoom in for precise focus as described on page 38; for more information on focusing during movie recording, see page 83). Note that the number of subjects that can be detected in face-priority AF drops during movie recording.



Exposure

The exposure settings available vary with the shooting mode:

	Shutter speed	ISO sensitivity (\square 275)	Exposure compensation	Metering
P, S	—	—	✓	✓
A	—	—	✓	✓
M	✓	✓	—	✓
SCENE, 	—	—	✓	—
Other shooting modes	—	—	—	—

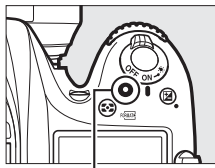
In mode M, shutter speed can be set to values between $1/25$ s and $1/8000$ s (the slowest available shutter speed varies with the frame rate; \square 166). Spot metering is not available. If the result is over- or under-exposed, exit and restart live view.

White Balance

In modes P, S, A, and M, white balance can be set at any time by pressing the WB button and rotating the main command dial (\square 111).

4 Start recording.

Press the movie-record button to start recording. A recording indicator and the time available are displayed in the monitor. Exposure can be locked by pressing the AE-L/AF-L button (📖 107) or altered by up to ± 3 EV in steps of $\frac{1}{3}$ EV using exposure compensation (📖 109). In autofocus mode, the camera can be refocused by pressing the shutter-release button halfway.



Movie-record button

Recording indicator



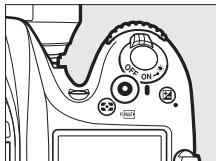
Time remaining

Audio

The camera can record both video and sound; do not cover the microphone on the front of the camera during movie recording (📖 1). Note that the built-in microphone may record sounds made by the camera or lens during autofocus or vibration reduction.

5 End recording.

Press the movie-record button again to end recording. Recording will end automatically when the maximum length is reached, or the memory card is full.

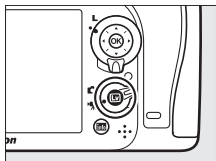


Maximum Length

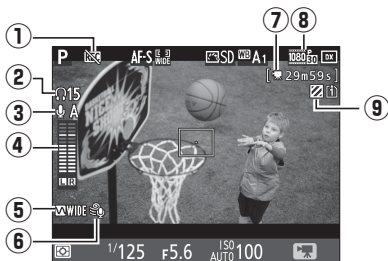
The maximum length for individual movie files is 4 GB (for maximum recording times, see page 166); note that depending on memory card write speed, shooting may end before this length is reached (📖 379).

6 Exit live view.

Press the  button to exit live view.



The Live View Display: Movies



Item	Description	
① "No movie" icon	Indicates that movies can not be recorded.	—
② Headphone volume	Volume of audio output to headphones. Displayed when third-party headphones are connected.	193
③ Microphone sensitivity	Microphone sensitivity.	192, 273
④ Sound level	Sound level for audio recording. Displayed in red if level is too high; adjust microphone sensitivity accordingly.	—
⑤ Frequency response	The current frequency response.	192, 274
⑥ Wind noise reduction	Displayed when wind noise reduction is on.	192, 274
⑦ Time remaining (movie live view)	The recording time available for movies.	163
⑧ Movie frame size	The frame size for movie recording.	166
⑨ Highlight display indicator	Appears when highlight display is enabled.	193

Maximum Length

The maximum length varies with the options selected for **Movie quality** and **Frame size/frame rate** in the movie shooting menu (☐ 273) as shown below.


Movie quality	Frame size/frame rate *	Maximum length	Maximum bit rate (Mbps)
High quality	$\frac{1080}{50} \frac{P^*}{50}$ 1920 × 1080; 60p	10 min.	42
	$\frac{1080}{50} \frac{P^*}{50}$ 1920 × 1080; 50p		
	$\frac{1080}{50} \frac{P^*}{30}$ 1920 × 1080; 30p	20 min.	24
	$\frac{1080}{25} \frac{P^*}{25}$ 1920 × 1080; 25p		
	$\frac{1080}{24} \frac{P^*}{24}$ 1920 × 1080; 24p		
	$\frac{720}{50} \frac{P^*}{50}$ 1280 × 720; 60p		
	$\frac{720}{50} \frac{P^*}{50}$ 1280 × 720; 50p		
Normal	$\frac{1080}{50} \frac{P}{50}$ 1920 × 1080; 60p	29 min. 59 s	12
	$\frac{1080}{50} \frac{P}{50}$ 1920 × 1080; 50p		
	$\frac{1080}{50} \frac{P}{30}$ 1920 × 1080; 30p		
	$\frac{1080}{25} \frac{P}{25}$ 1920 × 1080; 25p		
	$\frac{1080}{24} \frac{P}{24}$ 1920 × 1080; 24p		
	$\frac{720}{50} \frac{P}{50}$ 1280 × 720; 60p		
	$\frac{720}{50} \frac{P}{50}$ 1280 × 720; 50p		

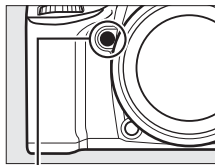
* Listed values. Actual frame rates for 60p, 50p, 30p, 25p, and 24p are 59.94, 50, 29.97, 25, and 23.976 fps respectively.

Frame Size and Rate

Settings of **1920×1080; 60p** and **1920×1080; 50p** are not available for **Frame size/frame rate** when **DX (24×16)** is selected for **Image area** in the movie shooting menu (☐ 168). These settings can be accessed by setting **Image area** to **1.3× (18×12)**. Choosing **DX (24×16)** for **Image area** when either of these options is in effect resets **Frame size/frame rate** to **1920×1080; 30p** (if **1920×1080; 60p** is selected) or to **1920×1080; 25p** (if **1920×1080; 50p** is selected).

Indices

If **Index marking** is selected as the “Press” option for Custom Setting g1 (**Assign Fn button**, □ 288), g2 (**Assign preview button**, □ 288), or g3 (**Assign AE-L/AF-L button**, □ 288), you can press the selected button during recording to add indices that can be used to locate frames during editing and playback (□ 178; note that indices can not be added in  mode). Up to 20 indices can be added to each movie.



Pv button



Index

See Also



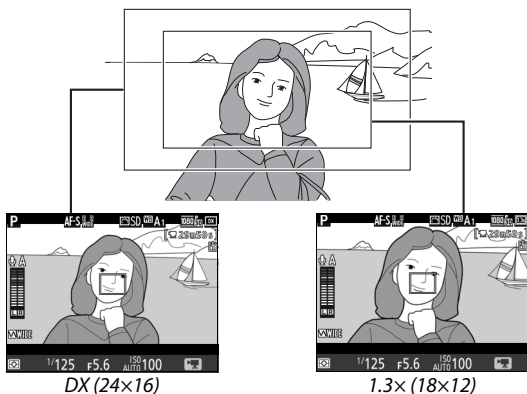
Frame size, frame rate, microphone sensitivity, card slot, and ISO sensitivity options are available in the movie shooting menu (□ 273). The roles played by the , **Fn**, **Pv**, and  **AE-L/AF-L** buttons can be chosen using Custom Settings f1 (**OK button**; □ 284), g1 (**Assign Fn button**; □ 288), g2 (**Assign preview button**; □ 288), and g3 (**Assign AE-L/AF-L button**, □ 288), respectively (the last three options also allow you to lock exposure without having to keep a button pressed). Custom Setting g4 (**Assign shutter button**; □ 288) controls whether the shutter-release button can be used to start live view or to start and end movie recording.

Image Area

Selecting **1.3x (18×12)** for **Image area** in the movie shooting menu (📖 274) reduces the angle of view and increases the apparent focal length of the lens. Note that movies recorded at the same frame size but with different image areas may not have the same resolution.



Taking Photos in Movie Mode







If **Take photos** is selected for Custom Setting g4 (**Assign shutter button**,  288) and live view is enabled with the live view selector is rotated to , photographs can be taken at any time by pressing the shutter-release button all the way down. If movie recording is in progress, recording will end and the footage recorded to that point will be saved. The photograph will be recorded at the current image area setting using a crop with an aspect ratio of 16 : 9. Image quality is determined by the option selected for **Image quality** in the photo shooting menu ( 77, 268). Note that exposure for photographs can not be previewed while the live view selector is rotated to ; for accurate results when shooting in mode **M**, rotate the selector to , adjust exposure, and then rotate the selector back to  and start live view. Check the image area before recording.



Image Size

The following sizes are available:


Image area	Image size	Size (pixels)	Print size (cm/in.)*
DX (24×16)	Large	6000 × 3368	50.8 × 28.5/20.0 × 11.2
	Medium	4496 × 2528	38.1 × 21.4/15.0 × 8.4
	Small	2992 × 1680	25.3 × 14.2/10.0 × 5.6
1.3× (18×12)	Large	4800 × 2696	40.6 × 22.8/16.0 × 9.0
	Medium	3600 × 2024	30.5 × 17.1/12.0 × 6.7
	Small	2400 × 1344	20.3 × 11.4/ 8.0 × 4.5

* Approximate size when printed at 300 dpi. Print size in inches equals image size in pixels divided by printer resolution in **dots per inch** (dpi); 1 inch = approximately 2.54 cm).

HDMI

To use live view when the camera is connected to an HDMI-CEC device, select **Off** for **HDMI > Device control** in the setup menu (□ 292).

Wireless Remote Controllers and Remote Cords

If **Record movies** is selected for Custom Setting g4 (**Assign shutter button**, □ 288) and the live view selector is rotated to , the shutter-release buttons on optional wireless remote controllers (□ 160, 319) and remote cords (□ 319) can be used to start live view and to start and end movie recording.

Recording Movies


Movies are recorded in the sRGB color space. Flicker, banding, or distortion may be visible in the monitor and in the final movie under fluorescent, mercury vapor, or sodium lamps or with subjects that are in motion, particularly if the camera is panned horizontally or an object moves horizontally at high speed through frame (for information on reducing flicker and banding, see **Flicker reduction**, □ 290). Jagged edges, color fringing, moiré, and bright spots may also appear. Bright regions or bands may appear in some areas of the frame with flashing signs and other intermittent light sources or if the subject is briefly illuminated by a strobe or other bright, momentary light source. Avoid pointing the camera at the sun or other strong light sources. Failure to observe this precaution could result in damage to the camera's internal circuitry.

Flash lighting can not be used.



Recording ends automatically if the mode dial is rotated.

Time-Lapse Photography


(, , P, S, A, M, and SCENE Modes Only)

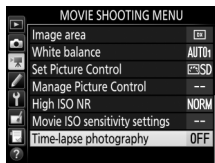
The camera automatically takes photos at selected intervals to create a silent time-lapse movie at the frame size and rate currently selected in the movie shooting menu ( 273). For information on the image area used for time-lapse movies, see page 168.

Before Shooting

Before beginning time-lapse photography, take a test shot at current settings (framing the photo in the viewfinder for an accurate exposure preview) and view the results in the monitor. For consistent coloration, choose a white balance setting other than auto ( 111). Once settings have been adjusted to your satisfaction, remove the rubber eyecup and cover the viewfinder with the supplied eyepiece cap to prevent light entering via the viewfinder interfering with photographs and exposure ( 70).

Use of a tripod is recommended. Mount the camera on a tripod before shooting begins. To ensure that shooting is not interrupted, use an optional AC adapter and power connector or a fully-charged battery.

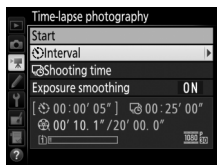
- 1 Select Time-lapse photography.** Highlight **Time-lapse photography** in the movie shooting menu and press  to display time-lapse photography settings.



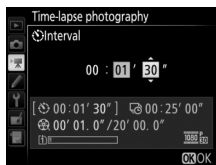
2 Adjust time-lapse photography settings.


Choose an interval, total shooting time, and exposure smoothing option.

- To choose the interval between frames:



Highlight **Interval** and press .




Choose an interval longer than the slowest anticipated shutter speed (minutes and seconds) and press .

- To choose the total shooting time:

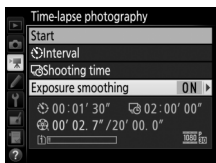


Highlight **Shooting time** and press .

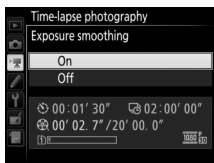


Choose shooting time (up to 7 hours 59 minutes) and press .

- To enable or disable exposure smoothing:



Highlight **Exposure smoothing** and press \odot .



Highlight an option and press \odot .

Selecting **On** smooths abrupt changes in exposure in modes other than **M** (note that exposure smoothing only takes effect in mode **M** if auto ISO sensitivity control is on).

3 Start shooting.

Highlight **Start** and press \odot . Time-lapse photography starts after about 3 s. The camera takes photographs at the selected interval for the selected shooting time. When complete, time-lapse movies are recorded to the memory card selected for **Destination** in movie shooting menu (📖 273).



■ ■ *Ending Time-Lapse Photography*

To end time-lapse photography before all the photos are taken, highlight **Off** in the time-lapse photography menu and press **OK**, or press **OK** between frames or immediately after a frame is recorded. A movie will be created from the frames shot to the point where time-lapse photography ended. Note that time-lapse photography will end and no movie will be recorded if the power source is removed or disconnected or the destination memory card is ejected.

■ ■ *No Photograph*

The camera will skip the current frame if it is unable to focus using single-servo autofocus (**AF-S** or single-servo autofocus selected for **AF-A**; note that the camera focuses again before each shot). Shooting will resume with the next frame.

✓ **Time-Lapse Photography**

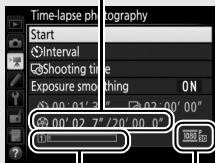
Time-lapse is not available in live view (□ 31, 161), at a shutter speed of **1/4000** or - (□ 58), when bracketing (□ 197), High Dynamic Range (HDR, □ 141), multiple exposure (□ 211), or interval timer photography (□ 217) is active. Note that because shutter speed and the time needed to record the image to the memory card may vary from shot to shot, the interval between a shot being recorded and the start of the next shot may vary. Shooting will not begin if a time-lapse movie can not be recorded at current settings (for example, if the memory card is full, the interval or shooting time is zero, or the interval is longer than the shooting time).

Time-lapse photography may end if camera controls are used or settings are changed or HDMI cable is connected. A movie will be created from the frames shot to the point where time-lapse photography ended.

Calculating the Length of the Final Movie

The total number of frames in the final movie can be approximated by dividing the shooting time by the interval and rounding up. The length of the final movie can then be calculated by dividing the number of shots by the frame rate selected for **Frame size/frame rate** in movie shooting menu (166, 273). A 48 frame movie recorded at **1920 x 1080; 24p**, for example, will be about two seconds long. The maximum length for movies recorded using time-lapse photography is 20 minutes.

*Length recorded/
maximum length*

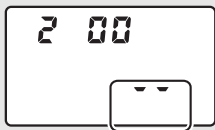


*Memory card
indicator*

*Frame size/
frame rate*

During Shooting

During time-lapse photography, the memory card access lamp will light and the time-lapse recording indicator will be displayed in the control panel. The time remaining (in hours and minutes) appears in the shutter-speed display immediately before each frame is recorded. At other times, the time remaining can be viewed by pressing the shutter-release button halfway. Regardless of the option selected for Custom Setting c2 (**Standby timer**, 279), the standby timer will not expire during shooting.



To view current time-lapse photography settings or end time-lapse photography, press the MENU button between shots.

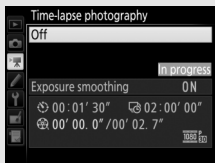





Image Review

The  button can not be used to view pictures while time-lapse photography is in progress, but the current frame will be displayed for a few seconds after each shot if **On** is selected for **Image review** in the playback menu (📖 267). Other playback operations can not be performed while the frame is displayed.

Flash Photography

To use the flash during time-lapse photography, select mode **P**, **S**, **A**, or **M** and press the  () button to raise the flash before shooting begins.




Release Mode

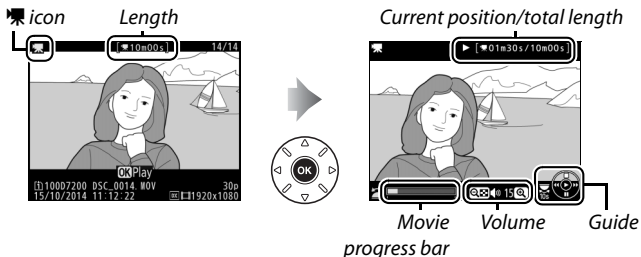
Regardless of the release mode selected, the camera will take one shot at each interval. The self-timer can not be used.

See Also







For information on setting a beep to sound when time-lapse photography is complete, see Custom Setting d1 (**Beep**, 📖 280).

Viewing Movies

Movies are indicated by a  icon in full-frame playback ( 229). Press  to start playback; your current position is indicated by the movie progress bar.



The following operations can be performed:

To	Use	Description
Pause		Pause playback.
Play		Resume playback when movie is paused or during rewind/advance.
Rewind/advance		Speed increases with  each press, from 2x to 4x to 8x to 16x; keep pressed to skip to beginning or end of movie (first frame is indicated by  in top right corner of monitor, last frame by ). If playback is paused, movie rewinds or advances one frame at a time; keep pressed for continuous rewind or advance.

To	Use	Description
Skip 10 s		Rotate the main command dial one stop to skip ahead or back 10 s.
Skip ahead/ back		Rotate the sub-command dial to skip to next or previous index, or to skip to the last or first frame if the movie contains no indices.
Adjust volume	(QUAL) / (ISO)	Press (QUAL) to increase volume, (ISO) to decrease.
Trim movie	i	See page 179 for more information.
Exit	/	Exit to full-frame playback.
Return to shooting mode		Press the shutter-release button halfway to exit to shooting mode.



The Icon

Movies with indices (167) are indicated by a icon in full-frame playback.



Editing Movies


Trim footage to create edited copies of movies or save selected frames as JPEG stills.

Option	Description
 Choose start/end point	Create a copy from which unwanted footage has been removed.
 Save selected frame	Save a selected frame as a JPEG still.





Trimming Movies



To create trimmed copies of movies:

1 Display a movie full frame ( 229).

2 Pause the movie on the new opening frame.

Play the movie back as described on page 177, pressing  to start and resume playback and  to pause and pressing  or  or rotating the main or sub-command dial to locate the desired frame. Your approximate

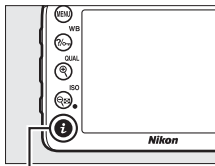
position in the movie can be ascertained from the movie progress bar. Pause playback when you reach the new opening frame.



Movie progress bar

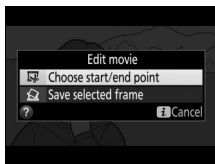
3 Select **Choose start/end point**.

Press the **i** button.



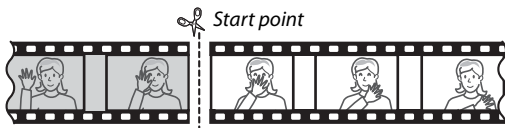
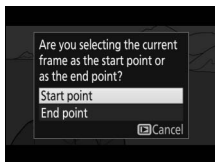
i button

Highlight **Choose start/end point**.





4 Select **Start point**.

To create a copy that begins from the current frame, highlight **Start point** and press **OK**. The frames before the current frame will be removed when you save the copy in Step 9.






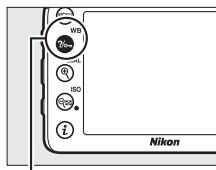
5 Confirm the new start point.


If the desired frame is not currently displayed, press  or  to advance or rewind (to skip to 10 s ahead or back, rotate the main command dial one stop; to skip to an index, or to the first or last frame if the movie contains no indices, rotate the sub-command dial).

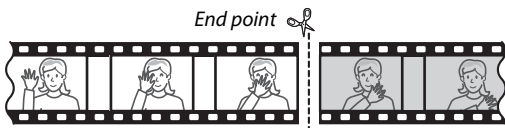


6 Choose the end point.


Press  (WB) to switch from the start point () to the end point () selection tool and then select the closing frame as described in Step 5. The frames after the selected frame will be removed when you save the copy in Step 9.



 (WB) button

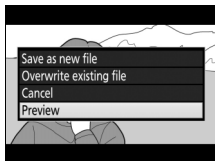


7 Create the copy.

Once the desired closing frame is displayed, press .

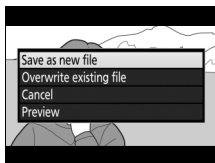
8 Preview the movie.

To preview the copy, highlight **Preview** and press **OK** (to interrupt the preview and return to the save options menu, press **OK**). To abandon the current copy and select a new start point or end point as described on the foregoing pages, highlight **Cancel** and press **OK**; to save the copy, proceed to Step 9.



9 Save the copy.

Highlight **Save as new file** and press **OK** to save the copy to a new file. To replace the original movie file with the edited copy, highlight **Overwrite existing file** and press **OK**.



Trimming Movies

Movies must be at least two seconds long. The copy will not be saved if there is insufficient space available on the memory card.

Copies have the same time and date of creation as the original.

Removing Opening or Closing Footage

To remove only the opening footage from the movie, proceed to Step 7 without pressing the **WB** button in Step 6. To remove only the closing footage, select **End point** in Step 4, select the closing frame, and proceed to Step 7 without pressing the **WB** button in Step 6.

The Retouch Menu

Movies can also be edited using the **Edit movie** option in the retouch menu (296).

Saving Selected Frames

To save a copy of a selected frame as a JPEG still:

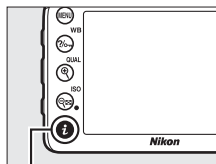
1 Pause the movie on the desired frame.

Play the movie back as described on page 177, pressing **OK** to start and resume playback and **STOP** to pause. Pause the movie at the frame you intend to copy.

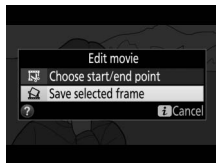


2 Choose Save selected frame.

Press the **i** button, then highlight **Save selected frame** and press **OK**.



i button



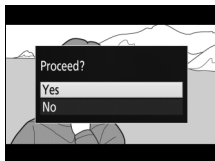
3 Create a still copy.

Press **STOP** to create a still copy of the current frame.



4 Save the copy.

Highlight **Yes** and press **OK** to create a fine-quality (📖 77) JPEG copy of the selected frame.



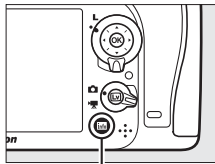
Save Selected Frame

JPEG movie stills created with the **Save selected frame** option can not be retouched. JPEG movie stills lack some categories of photo information (📖 234).

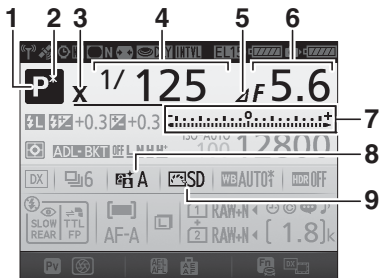
Other Shooting Options

The **info** Button (Viewfinder Photography)

Pressing the **info** button during viewfinder photography displays shooting information in the monitor including shutter speed, aperture, number of exposures remaining, and AF-area mode.

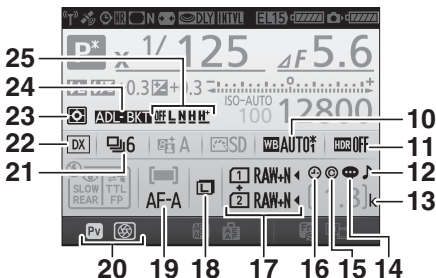


info button



- | | | | | | |
|---|----------------------------------|---------|---|---|-----|
| 1 | Shooting mode | 6 | 7 | Exposure indicator | 57 |
| 2 | Flexible program indicator | 52 | | Exposure compensation display | 109 |
| 3 | Flash sync indicator | 282 | | Bracketing progress indicator Exposure and flash bracketing | 198 |
| 4 | Shutter speed | 53, 56 | | WB bracketing | 203 |
| 5 | Aperture stop indicator | 54, 308 | 8 | Active D-Lighting indicator | 140 |
| 6 | Aperture (f-number) | 54, 56 | 9 | Picture Control indicator | 131 |
| | Aperture (number of stops) | 54, 308 | | | |

The Information Display (Continued)

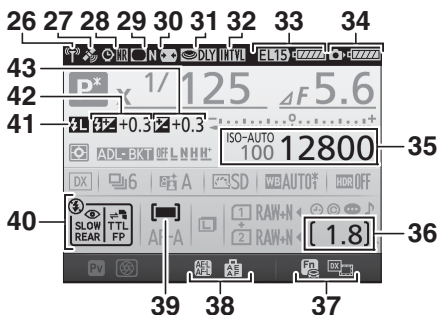


10 White balance..... 112	17 Image quality 78
White balance fine-tuning indicator..... 115	Role played by card in slot 2 82
11 HDR indicator..... 142	18 Image size..... 81
HDR strength 142	19 Autofocus mode 83
Multiple exposure indicator..... 214	20 Pv button assignment 285
12 “Beep” indicator 280	21 Release mode 8, 66
13 “k” (appears when memory remains for over 1000 exposures)..... 27	Continuous shooting speed..... 67
14 Image comment indicator..... 291	22 Image area indicator..... 74
15 Copyright information..... 291	23 Metering 105
16 “Clock not set” indicator 188	24 Exposure and flash bracketing indicator 198
	WB bracketing indicator 203
	ADL bracketing indicator..... 207
	25 ADL bracketing amount..... 208

Turning the Monitor Off

To clear shooting information from the monitor, press the **Info** button again or press the shutter-release button halfway. The monitor will turn off automatically if no operations are performed for about 10 seconds.

The Information Display (Continued)



<p>26 Wi-Fi connection indicator 252 Eye-Fi connection indicator 293</p> <p>27 Satellite signal indicator 228</p> <p>28 Long exposure noise reduction indicator 271</p> <p>29 Vignette control indicator 271</p> <p>30 Auto distortion control 271</p> <p>31 Exposure delay mode 280</p> <p>32 Interval timer indicator 217 Time-lapse indicator 171 Remote control mode (ML-L3) 156</p> <p>33 MB-D15 battery type display... 281 MB-D15 battery indicator 319</p> <p>34 Camera battery indicator.....22, 26</p> <p>35 ISO sensitivity indicator 100 ISO sensitivity 100 Auto ISO sensitivity indicator 103</p>	<p>36 Number of exposures remaining27 Time-lapse recording indicator 175</p> <p>37 Fn button assignment 284</p> <p>38 AE-L/AF-L button assignment ... 285</p> <p>39 AF-area mode indicator86</p> <p>40 Flash mode 144, 146</p> <p>41 FV lock indicator 154</p> <p>42 Flash compensation indicator 151 Flash compensation value 151</p> <p>43 Exposure compensation indicator 110 Exposure compensation value 109</p>
---	--

Note: Display shown with all indicators lit for illustrative purposes.

See Also

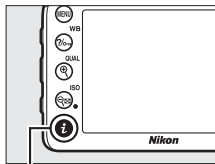
For information on choosing how long the monitor stays on, see Custom Setting c4 (**Monitor off delay**, [□ 279](#)). For information on changing the color of the lettering in the information display, see Custom Setting d9 (**Information display**, [□ 281](#)).

The ☹ (“Clock Not Set”) Icon

The camera clock is powered by an independent, rechargeable power source, which is charged as necessary when the main battery is installed or the camera is powered by an optional power connector and AC adapter ([□ 319](#)). Two days of charging will power the clock for about three months. If a ☹ icon flashes in the information display, the clock has been reset and the date and time recorded with new photographs will not be correct. Use the **Time zone and date > Date and time** option in the setup menu to set the clock to the correct time and date ([□ 290](#)).

The *i* Button

For quick access to frequently-used settings, press the *i* button. Highlight items and press \blacktriangleright to view options, then highlight the desired option and press OK to select. To exit the *i*-button menu and return to the shooting display, press the *i* button.



i button

Viewfinder photography

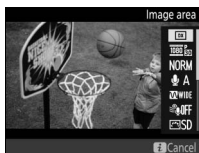


i-button menu

Live view



i-button menu
(live view selector
rotated to 📷)



i-button menu
(live view selector
rotated to 📺)


The **i**-Button Menu (Viewfinder Photography)



Pressing the **i** button during viewfinder photography displays a menu with the following options:

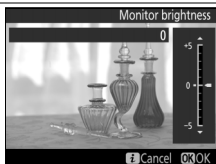
Option	Description
Image area	Choose from the DX (24×16) and 1.3× (18×12) image areas (☐ 73).
Set Picture Control	Choose a Picture Control (☐ 130).
Active D-Lighting	Adjust Active D-Lighting (☐ 139).
HDR (high dynamic range)	The camera combines two photographs taken at different exposures to enhance details in highlights and shadows (☐ 141).
Remote control mode (ML-L3)	Choose a remote control mode (☐ 156).
Assign Fn button	Choose the role played by the Fn button (☐ 284), either by itself (Press) or when used in combination with the command dials (Press + command dials).
Assign preview button	Choose the role played by the Pv button (☐ 285), either by itself (Press) or when used in combination with the command dials (Press + command dials).
Assign AE-L/AF-L button	Choose the role played by the ^{AE-L} _{AF-L} AE-L/AF-L button (☐ 285), either by itself (Press) or when used in combination with the command dials (Press + command dials).
Long exposure NR	Reduces noise (bright spots or fog) at slow shutter speeds (☐ 271).
High ISO NR	Reduces noise (randomly-spaced bright pixels) that tends to occur as ISO sensitivity increases (☐ 271).

The *i*-Button Menu (Live View)



The options available in the live view *i*-button menu vary with the position of the live view selector.




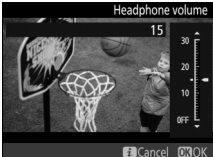
If the live view selector is rotated to , the *i*-button menu will contain the items listed below.

Option	Description
Image area	Choose from the DX (24×16) and 1.3× (18×12) image areas (☞ 73).
Image quality	Choose image quality (☞ 77).
Image size	Choose image size (☞ 81).
Set Picture Control	Choose a Picture Control (☞ 130).
Active D-Lighting	Adjust Active D-Lighting (☞ 139).
Remote control mode (ML-L3)	Choose a remote control mode (☞ 156).
Monitor brightness	Press  or  to adjust monitor brightness for live view (note that this affects live view only and has no effect on photographs or movies or on the brightness of the monitor for menus or playback; to adjust the brightness of the monitor for menus and playback without affecting live view, use the Monitor brightness option in the setup menu (☞ 289)).



If the live view selector is rotated to 塲, the **i**-button menu will contain the items listed below. **Microphone sensitivity**, **Frequency response**, **Wind noise reduction**, and **Highlight display** can be adjusted while recording is in progress.

Option	Description
Image area	Choose from the DX (24×16) and 1.3× (18×12) image areas (☐ 168).
Frame size/ frame rate	Select a frame size and rate (☐ 166).
Movie quality	Choose movie quality (☐ 166).
Microphone sensitivity	<p>Press ⬆ or ⬇ to adjust microphone sensitivity. Both the built-in and optional stereo microphones are affected.</p> 
Frequency response	Control the frequency response of the built-in microphone or optional stereo microphones (☐ 274).
Wind noise reduction	Enable or disable wind noise reduction using the built-in microphone's low-cut filter (☐ 274).
Set Picture Control	Choose a Picture Control (☐ 130). The Clarity parameter does not apply to movies.
Destination	When two memory cards are inserted, you can choose the card to which movies are recorded (☐ 273).
Monitor brightness	<p>Press ⬆ or ⬇ to adjust monitor brightness for live view (note that this affects live view only and has no effect on photographs or movies or on the brightness of the monitor for menus or playback; ☐ 191).</p> 

Option	Description
Highlight display	<p>Choose whether the brightest areas of the frame (highlights) are shown by slanting lines in the live view display. To access this option, select mode P, S, A, or M.</p> 
Headphone volume	<p>Press  or  to adjust headphone volume.</p> 



Using an External Microphone

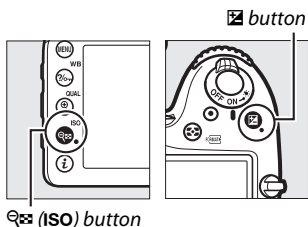
The optional stereo microphone can be used to record sound in stereo or to avoid recording focus noise and other sounds made by the lens (📖 319).

Headphones


Third-party headphones can be used. Note that high sound levels may result in high volume; particular care should be taken when headphones are used.

Two-Button Reset: Restoring Default Settings

The camera settings listed below can be restored to default values by holding the  (ISO) and  buttons down together for more than two seconds (these buttons are marked by a green dot). The control panel turns off briefly while settings are reset.




















Menu Options


Option	Default	
Image quality	JPEG normal	77
Image size	Large	81
White balance	Auto > Normal	111
Fine tuning	A-B: 0, G-M: 0	114
Picture Control settings ¹	Unmodified	130
HDR (high dynamic range)	Off ²	141
ISO sensitivity settings		
ISO sensitivity		
P, S, A, M	100	99
Other modes	Auto	
Hi ISO command dial access	Off	101
Auto ISO sensitivity control	Off	102
Remote control mode (ML-L3)	Off	156
Multiple exposure	Off ³	211
Interval timer shooting	Off ⁴	217
Exposure delay mode	Off	280

- 1 Current Picture Control only.
- HDR strength is not reset.
- If multiple exposure is currently in progress, shooting will end and multiple exposure will be created from exposures recorded to that point. Gain and number of shots are not reset.
- If interval timer shooting is currently in progress, shooting will end. Starting time, shooting interval, number of intervals and shots, and exposure smoothing are not reset.

■ ■ Other Settings

Option	Default	
Autofocus (viewfinder)		
Autofocus mode		
	AF-S	83
Other modes	AF-A	
AF-area mode		
	Single-point AF	86
	51-point dynamic-area AF	
AUTO  P, S, A, M	Auto-area AF	
Autofocus (live view)		
Autofocus mode		
	AF-S	84
AF-area mode		
 P, S, A, M	Wide-area AF	88
	Normal-area AF	
AUTO 	Face-priority AF	
Focus point ¹	Center	89
Highlight display	Off	193
Headphone volume	15	193
Metering	Matrix	105
AE lock hold	Off	93, 107
Bracketing	Off ²	197

Option	Default	
Flash compensation	Off	151
Exposure compensation	Off	109
Flash mode		
     	Auto	145, 147
	Auto+red-eye reduction	
	Auto+slow sync	
Tt, P, S, A, M	Fill flash	
FV lock	Off	153
Flexible program	Off	52
+ NEF (RAW)	Off	79

- 1 Focus point not displayed if auto-area AF is selected for AF-area mode.
- 2 Number of shots is reset to zero. Bracketing increment is reset to 1 EV (exposure/flash bracketing) or 1 (white balance bracketing).  **Auto** is selected for the second shot of two-shot ADL bracketing programs.

Bracketing

(P, S, A, and M Modes Only)

Bracketing automatically varies exposure, flash level, Active D-Lighting (ADL), or white balance slightly with each shot, “bracketing” the current value. Choose in situations in which it is difficult to set exposure, flash level (i-TTL and, where supported, auto aperture flash control modes only; see pages 149, 283, and 313), white balance, or Active D-Lighting and there is not time to check results and adjust settings with each shot, or to experiment with different settings for the same subject.

■ Exposure and Flash Bracketing

Vary exposure and/or flash level over a series of photographs.



Exposure modified by:
0 EV



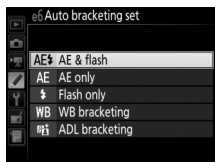
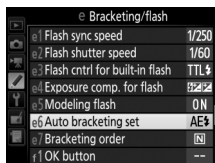
Exposure modified by:
-1 EV



Exposure modified by:
+1 EV

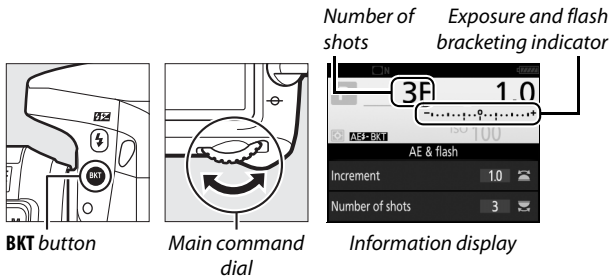
1 Select flash or exposure bracketing.

Select Custom Setting e6 (**Auto bracketing set**) in the Custom Settings menu, highlight an option, and press **OK**. Choose **AE & flash** to vary both exposure and flash level, **AE only** to vary only exposure, or **Flash only** to vary only flash level.



2 Choose the number of shots.

Pressing the **BKT** button, rotate the main command dial to choose the number of shots in the bracketing sequence.



At settings other than zero, a **BKT** icon is displayed in the control panel.

BKT appears in the viewfinder, while

the information display provides a bracketing indicator and an icon showing the type of bracketing: **AE-BKT** (exposure and flash bracketing), **AE-BKT** (exposure bracketing only), or **BKT** (flash bracketing only).

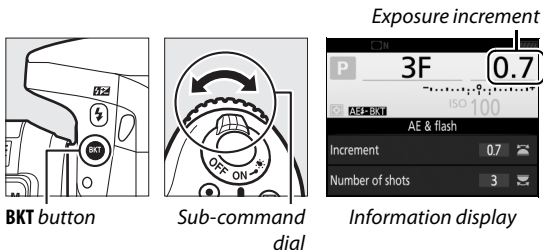


Live View

In live view, bracketing settings are displayed in the monitor.

3 Select an exposure increment.

Pressing the **BKT** button and rotate the sub-command dial to choose the exposure increment.



At default settings, the size of the increment can be chosen from 0.3 ($\frac{1}{3}$), 0.7 ($\frac{2}{3}$), 1, 2, and 3 EV. The bracketing programs with an increment of 0.3 ($\frac{1}{3}$) EV are listed below.

Information display	No. of shots	Bracketing order (EVs)
0F 0.3	0	0
+3F 0.3	3	0/+0.3/+0.7
-3F 0.3	3	0/-0.7/-0.3
+2F 0.3	2	0/+0.3
-2F 0.3	2	0/-0.3
3F 0.3	3	0/-0.3/+0.3
5F 0.3	5	0/-0.7/-0.3/+0.3/+0.7
7F 0.3	7	0/-1.0/-0.7/-0.3/+0.3/+0.7/+1.0
9F 0.3	9	0/-1.3/-1.0/-0.7/-0.3/+0.3/+0.7/+1.0/+1.3

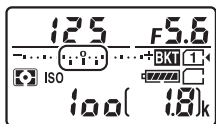
Note that for exposure increments of 2 EV or more, the maximum number of shots is 5; if a higher value was selected in Step 2, the number of shots will automatically be set to 5.

4 Frame a photograph, focus, and shoot.

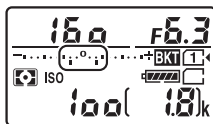
The camera will vary exposure and/or flash level shot-by-shot according to the bracketing program selected. Modifications to exposure are added to those made with exposure compensation (see page 109).



A bracketing progress indicator is displayed while bracketing is in effect. A segment will disappear from the indicator after each shot.



No. shots: 3; increment: 0.7



Display after first shot

See Also

For information on choosing the size of the increment, see Custom Setting b2 (**EV steps for exposure cntrl**, [□ 278](#)). For information on choosing the order in which bracketing is performed, see Custom Setting e7 (**Bracketing order**, [□ 284](#)).

■ ■ *Canceling Bracketing*

To cancel bracketing, press the **BKT** button and rotate the main command dial until no shots remain in the bracketing sequence. The program last in effect will be restored the next time bracketing is activated. Bracketing can also be cancelled by performing a two-button reset (☞ 194), although in this case the bracketing program will not be restored the next time bracketing is activated.

☑ **Zero Shots**

The live view display shows “-/-” when no shots remain in the bracketing sequence.

☑ **Exposure and Flash Bracketing**

In continuous release modes (☞ 66), shooting will pause after the number of shots specified in the bracketing program have been taken. Shooting will resume the next time the shutter-release button is pressed. In self-timer mode, the camera will take the number of shots selected in Step 2 on page 198 each time the shutter-release button is pressed, regardless of the option selected for Custom Setting c3 (**Self-timer**) > **Number of shots** (☞ 279); the interval between shots is however controlled by Custom Setting c3 (**Self-timer**) > **Interval between shots**. In other modes, one shot will be taken each time the shutter-release button is pressed.

If the memory card fills before all shots in the sequence have been taken, shooting can be resumed from the next shot in the sequence after the memory card has been replaced or shots have been deleted to make room on the memory card. If the camera is turned off before all shots in the sequence have been taken, bracketing will resume from the next shot in the sequence when the camera is turned on.

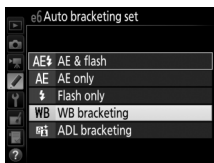
Exposure Bracketing

The camera modifies exposure by varying shutter speed and aperture (mode **P**), aperture (mode **S**), or shutter speed (modes **A** and **M**). If **On** is selected for **ISO sensitivity settings > Auto ISO sensitivity control** (☐ 102) in modes **P**, **S**, and **A**, the camera will automatically vary ISO sensitivity for optimum exposure when the limits of the camera exposure system are exceeded; in mode **M**, the camera will first use auto ISO sensitivity control to bring exposure as close as possible to the optimum and then bracket this exposure by varying shutter speed.

White Balance Bracketing

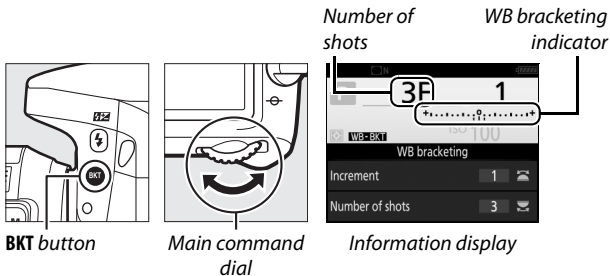
The camera creates multiple copies of each photograph, each with a different white balance. For more information on white balance, see page 111.

- 1 Select white balance bracketing.**
Choose **WB bracketing** for Custom Setting e6 (**Auto bracketing set**).



2 Choose the number of shots.

Pressing the **BKT** button, rotate the main command dial to choose the number of shots in the bracketing sequence.



At settings other than zero, **BKT** and **BKT** are displayed respectively in the control panel and viewfinder; a



Viewfinder

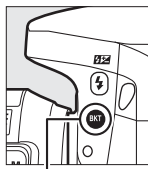
WB-BKT icon and a bracketing indicator appear in the information display.

Live View

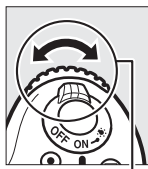
In live view, bracketing settings are displayed in the monitor.

3 Select a white balance increment.

Pressing the **BKT** button, rotate the sub-command dial to choose from increments of 1, 2, or 3 (respectively equivalent to approximately 5, 10, or 15 mired). The **B** value indicates the amount of blue, the **A** value the amount of amber (☞ 114).

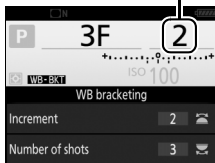


BKT button



Sub-command dial

White balance increment



Information display

The bracketing programs with an increment of 1 are listed below.

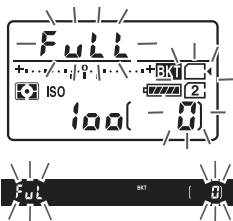
Information display	No. of shots	White balance increment	Bracketing order
B2F 1 +.....;0;.....+	2	1 B	0/1 B
A2F 1 +.....;0;.....+	2	1 A	0/1 A
3F 1 +.....;0;.....+	3	1 A, 1 B	0/1 A/1 B

4 Frame a photograph, focus, and shoot.

Each shot will be processed to create the number of copies specified in the bracketing program, and each copy will have a different white balance. Modifications to white balance are added to the white balance adjustment made with white balance fine-tuning.



If the number of shots in the bracketing program is greater than the number of exposures remaining, **FULL** and the icon for the affected card will flash in the control panel, a flashing **FuL** icon will appear in the viewfinder as shown at right, and the shutter release will be disabled. Shooting can begin when a new memory card is inserted.



■ ■ *Canceling Bracketing*

To cancel bracketing, press the **BKT** button and rotate the main command dial until no shots remain in the bracketing sequence. The program last in effect will be restored the next time bracketing is activated. Bracketing can also be cancelled by performing a two-button reset (☐ 194), although in this case the bracketing program will not be restored the next time bracketing is activated.

✍ **Zero Shots**

The live view display shows “-/-” when no shots remain in the bracketing sequence.

✍ **White Balance Bracketing**

White balance bracketing is not available at an image quality of NEF (RAW). Selecting **NEF (RAW)**, **NEF (RAW) + JPEG fine**, **NEF (RAW) + JPEG normal**, or **NEF (RAW) + JPEG basic** cancels white balance bracketing.

White balance bracketing affects only color temperature (the amber-blue axis in the white balance fine-tuning display, ☐ 114). No adjustments are made on the green-magenta axis.

In self-timer mode (☐ 69), the number of copies specified in the white-balance program will be created each time the shutter is released, regardless of the option selected for Custom Setting c3 (**Self-timer**) > **Number of shots** (☐ 279).

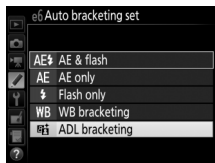
If the camera is turned off while the memory card access lamp is lit, the camera will power off only after all photographs in the sequence have been recorded.

■ ■ ADL Bracketing

The camera varies Active D-Lighting over a series of exposures. For more information on Active D-Lighting, see page 139.

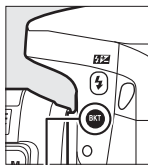
1 Select ADL bracketing.

Choose **ADL bracketing** for Custom Setting e6 (**Auto bracketing set**).



2 Choose the number of shots.

Pressing the **BKT** button, rotate the main command dial to choose the number of shots in the bracketing sequence.

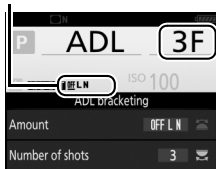


BKT button



Main command dial

ADL bracketing amount Number of shots



Information display

At settings other than zero, **BKT** and **BKT** are displayed respectively in the control panel and viewfinder; a **ADL-BKT** icon and the bracketing amount appear in the information display.

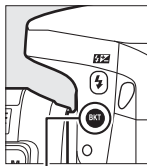


Viewfinder

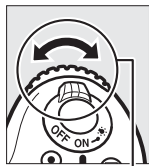
Choose two shots to take one photograph with Active D-Lighting off and another at a selected value. Choose three to five shots to take a series of photographs with Active D-Lighting set to **Off**, **Low**, and **Normal** (three shots), **Off**, **Low**, **Normal**, and **High** (four shots), or **Off**, **Low**, **Normal**, **High**, and **Extra high** (five shots). If you choose more than two shots, proceed to Step 4.

3 Select Active D-Lighting.

Pressing the **BKT** button, rotate the sub-command dial to choose Active D-Lighting.



BKT button



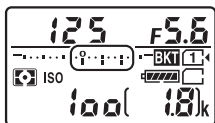
Sub-command dial

Active D-Lighting is shown in the information display and control panel.

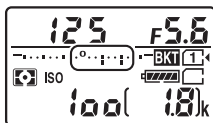
Active D-Lighting	Information display	Control panel display
A Auto	<u>OFF</u> AUTOBKT Auto
L Low	<u>OFF</u> LBKT L
N Normal	<u>OFF</u> NBKT N
H High	<u>OFF</u> HBKT H
H ⁺ Extra high	<u>OFF</u> H ⁺BKT HP

4 Frame a photograph, focus, and shoot.

The camera will vary Active D-Lighting shot-by-shot according to the bracketing program selected. A bracketing progress indicator is displayed while bracketing is in effect. A segment will disappear from the indicator after each shot.



No. shots: 3



Display after first shot

Live View

In live view, bracketing settings are displayed in the monitor.

■ ■ *Canceling Bracketing*

To cancel bracketing, press the **BKT** button and rotate the main command dial until no shots remain in the bracketing sequence. The program last in effect will be restored the next time bracketing is activated. Bracketing can also be cancelled by performing a two-button reset (☐ 194), although in this case the bracketing program will not be restored the next time bracketing is activated.

🔪 **Zero Shots**

The live view display shows “-/-” when no shots remain in the bracketing sequence.

🔪 **ADL Bracketing**

In continuous release modes (☐ 66), shooting will pause after the number of shots specified in the bracketing program have been taken. Shooting will resume the next time the shutter-release button is pressed. In self-timer mode, the camera will take the number of shots selected in Step 2 on page 207 each time the shutter-release button is pressed, regardless of the option selected for Custom Setting c3 (**Self-timer**) > **Number of shots** (☐ 279); the interval between shots is however controlled by Custom Setting c3 (**Self-timer**) > **Interval between shots**. In other modes, one shot will be taken each time the shutter-release button is pressed.

If the memory card fills before all shots in the sequence have been taken, shooting can be resumed from the next shot in the sequence after the memory card has been replaced or shots have been deleted to make room on the memory card. If the camera is turned off before all shots in the sequence have been taken, bracketing will resume from the next shot in the sequence when the camera is turned on.

Multiple Exposure


(P, S, A, and M Modes Only)

Follow the steps below to record a series of two or three NEF (RAW) exposures in a single photograph.


■ Creating a Multiple Exposure

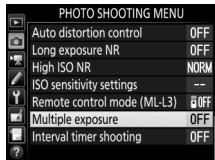
Multiple exposures can not be recorded in live view. Exit live view before proceeding. Note that at default settings, shooting will end and a multiple exposure will be recorded automatically if no operations are performed for about 30 s.

🔧 Extended Recording Times

If the monitor turns off during playback or menu operations and no operations are performed for about 30 s, shooting will end and a multiple exposure will be created from the exposures that have been recorded to that point. The time available to record the next exposure can be extended by choosing longer times for Custom Setting c2 (**Standby timer**,  279).

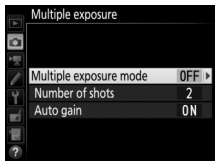
1 Select Multiple exposure.


Highlight **Multiple exposure** in the photo shooting menu and press .




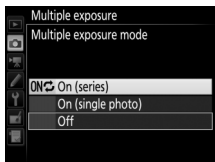
2 Select a mode.


Highlight **Multiple exposure mode** and press .

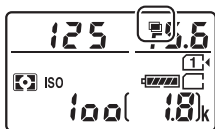



Highlight one of the following and press .

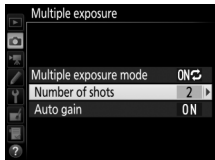
- **To take a series of multiple exposures**, select **ON  On (series)**. Multiple exposure shooting will continue until you select **Off** for **Multiple exposure mode**.
- **To take one multiple exposure**, select **On (single photo)**. Normal shooting will resume automatically after you have created a single multiple exposure.
- **To exit without creating additional multiple exposures**, select **Off**.






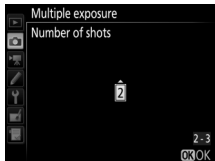
If **On (series)** or **On (single photo)** is selected, a  icon will be displayed in the control panel.



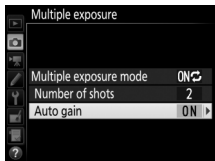
- 3 Choose the number of shots.**
Highlight **Number of shots** and press .




Press  or  to choose the number of exposures that will be combined to form a single photograph and press .

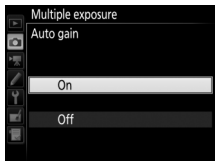


- 4 Choose the amount of gain.**
Highlight **Auto gain** and press .



The following options will be displayed. Highlight an option and press .



- **On:** Gain is adjusted according to number of exposures actually recorded (gain for each exposure is set to $\frac{1}{2}$ for 2 exposures, $\frac{1}{3}$ for 3 exposures).
- **Off:** Gain is not adjusted when recording multiple exposure.

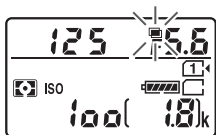


5 Frame a photograph, focus, and shoot.

In continuous release modes (☐ 66), the camera records all exposures in a single burst. If **On (series)** is selected, the camera will continue to record multiple exposures while the shutter-release button is pressed; if **On (single photo)** is selected, multiple exposure shooting will end after the first photograph. In self-timer mode, the camera will automatically record the number of exposures selected in Step 3 on page 213, regardless of the option selected for Custom Setting c3 (**Self-timer**) > **Number of shots** (☐ 279); the interval between shots is however controlled by Custom Setting c3 (**Self-timer**) > **Interval between shots**. In other release modes, one photograph will be taken each time the shutter-release button is pressed; continue shooting until all exposures have been recorded (for information on interrupting a multiple exposure before all photographs are recorded, see page 215).



The  icon will flash until shooting ends. If **On (series)** is selected, multiple exposure shooting will only end when **Off** is selected for multiple exposure mode; if **On (single photo)** is selected, multiple exposure shooting ends automatically when the multiple exposure is complete. The  icon clears from the display when multiple exposure shooting ends.



■ ■ *Interrupting Multiple Exposures*

To interrupt a multiple exposure before the specified number of exposures have been taken, select **Off** for multiple exposure mode. If shooting ends before the specified number of exposures have been taken, a multiple exposure will be created from the exposures that have been recorded to that point. If **Auto gain** is on, gain will be adjusted to reflect the number of exposures actually recorded. Note that shooting will end automatically if:

- A two-button reset is performed (📖 194)
- The camera is turned off
- The battery is exhausted
- Pictures are deleted

✔ **Multiple Exposures**

Do not remove or replace the memory card while recording a multiple exposure.

Live view is not available while shooting is in progress. Selecting live view resets **Multiple exposure mode** to **Off**.

The shooting information listed in the playback photo information display (including metering, exposure, shooting mode, focal length, date of recording and camera orientation) is for the first shot in the multiple exposure.

📷 **Interval Timer Photography**

If interval timer photography is activated before the first exposure is taken, the camera will record exposures at the selected interval until the number of exposures specified in the multiple exposure menu have been taken (the number of shots listed in the interval timer shooting menu is ignored). These exposures will then be recorded as a single photograph and interval timer shooting will end (if **On (single photo)** is selected for multiple exposure mode, multiple exposure shooting will also end automatically).

📷 **Other Settings**

While a multiple exposure is being shot, memory cards can not be formatted and some menu items are grayed out and can not be changed.

Interval Timer Photography

The camera is equipped to take photographs automatically at preset intervals.

☑ Before Shooting

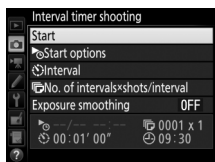
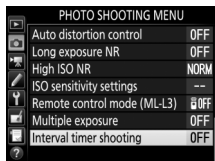
Select a release mode other than self-timer (⌚) and **MUP** when using the interval timer. Before beginning interval timer photography, take a test shot at current settings and view the results in the monitor. Once settings have been adjusted to your satisfaction, remove the rubber eyecup and cover the viewfinder with the supplied eyepiece cap to prevent light entering via the viewfinder interfering with photographs and exposure (📖 70).

Before choosing a starting time, select **Time zone and date** in the setup menu and make sure that the camera clock is set to the correct time and date (📖 290).

Use of a tripod is recommended. Mount the camera on a tripod before shooting begins. To ensure that shooting is not interrupted, be sure the camera battery is fully charged. If in doubt, charge the battery before use or use an AC adapter and power connector (available separately).

1 Select Interval timer shooting.

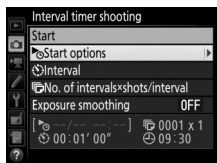
Highlight **Interval timer shooting** in the photo shooting menu and press **OK** to display interval timer settings.



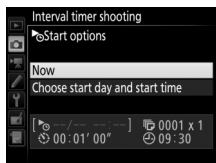
2 Adjust interval timer settings.

Choose a start option, interval, number of shots per interval, and exposure smoothing option.

- To choose a start option:



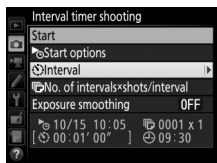
Highlight **Start options** and press \odot .



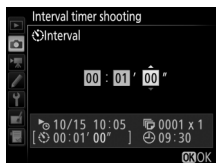
Highlight an option and press \odot .

To start shooting immediately, select **Now**. To start shooting at a chosen date and time, select **Choose start day and start time**, then choose the date and time and press \odot .

- To choose the interval between shots:

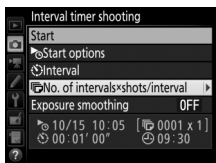


Highlight **Interval** and press \odot .

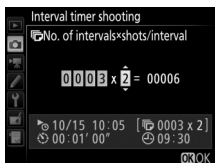


Choose an interval (hours, minutes, and seconds) and press \odot .

- To choose the number of shots per interval:



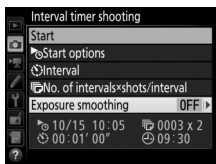
Highlight **No. of intervals x shots/interval** and press \odot .



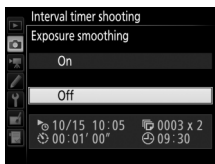
Choose the number of intervals and the number of shots per interval and press \odot .

In **S** (single frame) mode, the photographs for each interval will be taken at the rate chosen for Custom Setting d2 (**Continuous low-speed**, \square 280).

- To enable or disable exposure smoothing:



Highlight **Exposure smoothing** and press \odot .

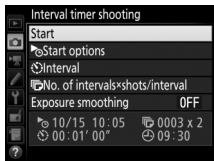


Highlight an option and press \odot .

Selecting **On** allows the camera to adjust exposure to match previous shot in modes other than **M** (note that exposure smoothing only takes effect in mode **M** if auto ISO sensitivity control is on).

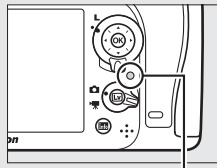
3 Start shooting.

Highlight **Start** and press **OK**. The first series of shots will be taken at the specified starting time, or after about 3 s if **Now** was selected for **Start options** in Step 2. Shooting will continue at the selected interval until all shots have been taken.



During Shooting

During interval timer photography, the memory card access lamp will flash. Immediately before the next shooting interval begins, the shutter speed display will show the number of intervals remaining, and the aperture display will show the number of shots remaining in the current interval. At other times, the number of intervals remaining and the number of shots in each interval can be viewed by pressing the shutter-release button halfway (once the button is released, the shutter speed and aperture will be displayed until the standby timer expires).



*Memory card
access lamp*

Settings can be adjusted, the menus used, and pictures played back while interval timer photography is in progress. The monitor will turn off automatically about four seconds before each interval. Note that changing camera settings while the interval timer is active may cause shooting to end.

Release Mode

Regardless of the release mode selected, the camera will take the specified number of shots at each interval.

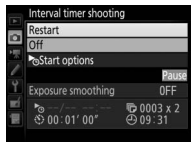
■ Pausing Interval Timer Photography

Interval timer photography can be paused between intervals by pressing **OK** or selecting **Pause** in the interval timer menu.

■ Resuming Interval Timer Shooting

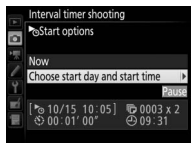
To resume shooting:

Starting Now

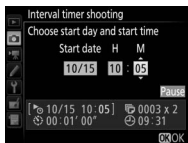


Highlight **Restart** and press **OK**.

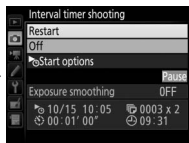
Starting at a Specified Time



For **Start options**, highlight **Choose start day and start time** and press **OK**.



Choose a starting date and time and press **OK**.



Highlight **Restart** and press **OK**.

■ Ending Interval Timer Shooting

To end interval timer photography before all the photos are taken, select **Off** in the interval timer menu.

■ No Photograph

The camera will skip the current interval if any of the following situations persist for eight seconds or more after the interval was due to start: the photograph or photographs for the previous interval have yet to be taken, the memory card is full, or the camera is unable to focus in **AF-S** or when single-servo AF is selected in **AF-A** (note that the camera focuses again before each shot). Shooting will resume with the next interval.

✓ Out of Memory

If the memory card is full, the interval timer will remain active but no pictures will be taken. Resume shooting (☐ 221) after deleting some pictures or turning the camera off and inserting another memory card.

✍ Interval Timer Photography

Choose an interval longer than the time needed to take the selected number of shots. If the interval is too short, the number of photos taken may be less than the total listed in Step 2 (the number of intervals multiplied by the number of shots per interval). Interval timer photography can not be combined with long time-exposures (bulb or time photography, ☐ 58) or time-lapse photography (☐ 171) and is not available in live view (☐ 31, 161) or when **Record movies** is selected for Custom Setting g4 (**Assign shutter button**, ☐ 288). Note that because the shutter speed, frame rate, and time needed to record images may vary from one interval to the next, the time between the end of one interval and the beginning of the next may vary. If shooting can not proceed at current settings (for example, if a shutter speed of **1/2000** or **- -** is currently selected in manual exposure mode, the interval is zero, or the start time is in less than a minute), a warning will be displayed in the monitor.

Interval timer shooting will pause when ☺ (self-timer) or **MUP** mode is selected or if the camera is turned off and then on again (when the camera is off, batteries and memory cards can be replaced without ending interval timer photography). Pausing shooting does not affect interval timer settings.

Bracketing

Adjust bracketing settings before starting interval timer photography. If exposure, flash, or ADL bracketing is active while interval timer photography is in effect, the camera will take the number of shots in the bracketing program at each interval, regardless of the number of shots specified in the interval timer menu. If white balance bracketing is active while interval timer photography is in effect, the camera will take one shot at each interval and process it to create the number of copies specified in the bracketing program.

Non-CPU Lenses

Non-CPU lenses can be used in modes **A** and **M**, with aperture set using the lens aperture ring. By specifying lens data (lens focal length and maximum aperture), the user can gain access to the following CPU lens functions.

If the focal length of the lens is known:

- Power zoom can be used with optional flash units
- Lens focal length is listed (with an asterisk) in the playback photo info display

If the maximum aperture of the lens is known:

- The aperture value is displayed in the control panel and viewfinder
- Flash level is adjusted for changes in aperture if the flash unit supports AA (auto aperture) mode
- Aperture is listed (with an asterisk) in the playback photo info display

Specifying both the focal length and maximum aperture of the lens:

- Enables color matrix metering (note that it may be necessary to use center-weighted or spot metering to achieve accurate results with some lenses, including Reflex-NIKKOR lenses)
- Improves the precision of center-weighted and spot metering and i-TTL balanced fill-flash for digital SLR

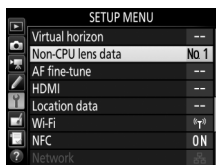
Teleconverters and Zoom Lenses

The maximum aperture for teleconverters is the combined maximum aperture of the teleconverter and the lens. Note that lens data are not adjusted when non-CPU lenses are zoomed in or out. The data for different focal lengths can be entered as separate lens numbers, or the data for the lens can be edited to reflect the new values for lens focal length and maximum aperture each time zoom is adjusted.



The camera can store data for up to nine non-CPU lenses. To enter or edit data for a non-CPU lens:

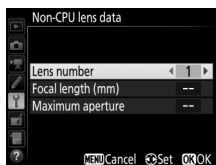
1 Select Non-CPU lens data.

Highlight **Non-CPU lens data** in the setup menu and press .





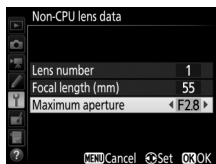
2 Choose a lens number.

Highlight **Lens number** and press  or  to choose a lens number.




3 Enter the focal length and aperture.

Highlight **Focal length (mm)** or **Maximum aperture** and press  or  to edit the highlighted item.



4 Save settings and exit.





Press . The specified focal length and aperture will be stored under the chosen lens number.

Focal Length Not Listed

If the correct focal length is not listed, choose the closest value greater than the actual focal length of the lens.

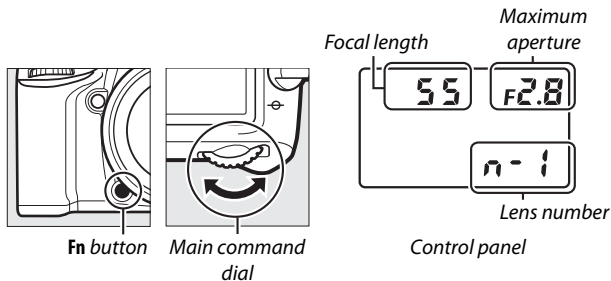
To recall lens data when using a non-CPU lens:

1 Assign non-CPU lens number selection to a camera control.

Select **Choose non-CPU lens number** as the “Press + command dials” option for a camera control in the Custom Settings menu. Non-CPU lens number selection can be assigned to the **Fn** button (Custom Setting f2, **Assign Fn button**,  284), the **Pv** button (Custom Setting f3, **Assign preview button**,  285), or the  **AE-L/AF-L** button (Custom Setting f4, **Assign AE-L/AF-L button**,  285).

2 Use the selected control to choose the lens number.

Press the selected button and rotate the main command dial until the desired lens number is displayed in the control panel.



Location Data

The GP-1/GP-1A GPS unit (available separately) can be connected to the camera's accessory terminal (□ 2) using the cable supplied with the GP-1/GP-1A, allowing information on the camera's current position to be recorded when photographs are taken. Turn the camera off before connecting the GP-1/GP-1A; for more information, see the GP-1/GP-1A manual.

■ ■ Setup Menu Options

The **Location data** item in the setup menu contains the options listed below.

- **Standby timer:** Choose whether the exposure meters turn off automatically when the GP-1/GP-1A is attached.


Option	Description
Enable	Exposure meters turn off automatically if no operations are performed for the period specified in Custom Setting c2 (Standby timer , □ 279; to allow the camera time to acquire location data, the delay is extended by up to one minute after the exposure meters are activated or the camera is turned on). This reduces the drain on the battery.
Disable	Exposure meters do not turn off while the GP-1/GP-1A is connected.




- **Position:** This item is only available if the GP-1/GP-1A is connected, when it displays the current latitude, longitude, altitude, and Coordinated Universal Time (UTC) as reported by the GP-1/GP-1A.
- **Set clock from satellite:** Select **Yes** to synchronize the camera clock with the time reported by the GPS device.

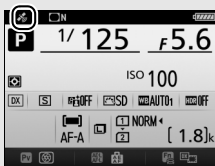
Coordinated Universal Time (UTC)

UTC data is provided by the GPS device and is independent of the camera clock.

The Icon

Connection status is shown by the  icon:

-  (**static**): The camera has established communication with GP-1/GP-1A. Photo information for pictures taken while this icon is displayed includes an additional page of location data (□ 241).
-  (**flashing**): The GP-1/GP-1A is searching for a signal. Pictures taken while the icon is flashing do not include location data.
- **No icon**: No new location data have been received from the GP-1/GP-1A for at least two seconds. Pictures taken when the  icon is not displayed do not include location data.



Information display




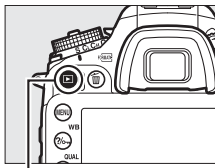
Shooting display

More on Playback

Viewing Pictures













Full-Frame Playback

To play photographs back, press the  button. The most recent photograph will be displayed in the monitor.



 button



To	Use	Description
View additional photographs		Press  to view photographs in order recorded,  to view photographs in reverse order.
View photo information		Press  or  to view information about current photograph (□ 234).
Return to shooting mode	 / 	Press the  button or press the shutter-release button halfway to exit to shooting mode.
Play movie		If current picture is marked with  icon to show that it is a movie, pressing  starts movie playback (□ 177).

Rotate Tall


To display “tall” (portrait-orientation) photographs in tall orientation, select **On** for the **Rotate tall** option in the playback menu (📖 267).

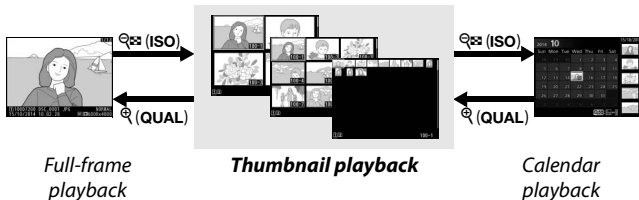











Image Review

When **On** is selected for **Image review** in the playback menu (📖 267), photographs are automatically displayed in the monitor after shooting (because the camera is already in the correct orientation, images are not rotated automatically during image review). In continuous release modes, display begins when shooting ends, with the first photograph in the current series displayed.


Thumbnail Playback

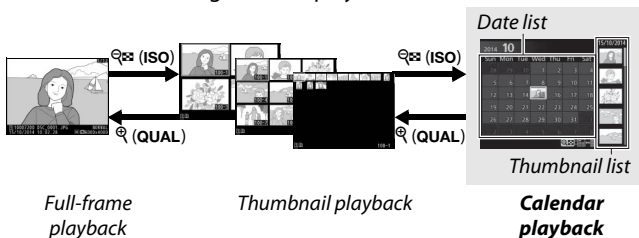
To display images in “contact sheets” of four, nine, or 72 images, press the  (ISO) button.















To	Use	Description
Highlight images		Use multi selector to highlight images for full-frame playback, playback zoom ( 243), deletion ( 246), or protection ( 245).
View highlighted image		Press  to display the highlighted image full frame.
Return to shooting mode	 / 	Press the  button or press the shutter-release button halfway to exit to shooting mode.

Calendar Playback

To view images taken on a selected date, press the  (ISO) button when 72 images are displayed.








The operations that can be performed depend on whether the cursor is in the date list or the thumbnail list:

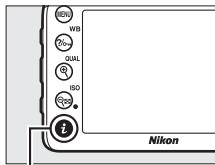
To	Use	Description
Toggle between date list and thumbnail list	 (ISO) / 	Press  (ISO) or  button in date list to place cursor in thumbnail list. Press  (ISO) again to return to date list.
Exit to thumbnail playback/Zoom in on highlighted photo	 (QUAL)	<ul style="list-style-type: none"> • Date list: Exit to 72-frame playback. • Thumbnail list: Press and hold  (QUAL) button to zoom in on highlighted picture.
Highlight dates/Highlight images		<ul style="list-style-type: none"> • Date list: Highlight date. • Thumbnail list: Highlight picture.
Toggle full frame playback		Thumbnail list: View highlighted picture.
Return to shooting mode	 / 	Press the  button or press the shutter-release button halfway to exit to shooting mode.

The *i* Button

Pressing the *i* button during full-frame or thumbnail playback displays the options listed below.

- **Playback slot and folder:** Choose a folder for playback. Highlight a slot and press  to list the folders on the selected card, then highlight a folder and press  to view the pictures in the highlighted folder.
- **Retouch (photographs only):** Use the options in the retouch menu ( 294) to create a retouched copy of the current photograph.
- **Edit movie (movies only):** Edit movies using the options in the edit movie menu ( 179). Movies can also be edited by pressing the *i* button when movie playback is paused.
- **Select to send to smart device/deselect:** Select photos for upload to a smart device ( 263).

To exit the *i*-button menu and return to playback, press the *i* button again.

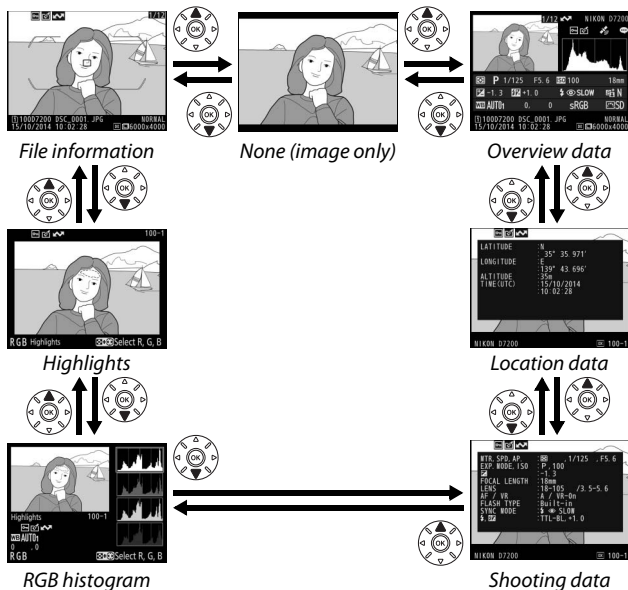


i button

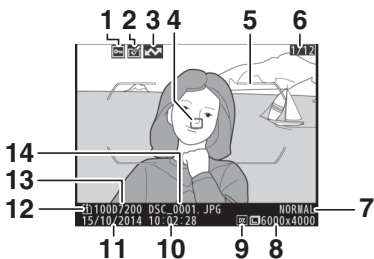


Photo Information

Photo information is superimposed on images displayed in full-frame playback. Press or to cycle through photo information as shown below. Note that “image only”, shooting data, RGB histograms, highlights, and overview data are only displayed if corresponding option is selected for **Playback display options** (📖 266). Location data are only displayed if a GP-1/GP-1A was used when the photo was taken (📖 227).



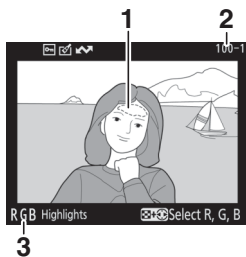
■ File Information



1	Protect status	245	8	Image size	81
2	Retouch indicator	294	9	Image area	73
3	Upload marking	263	10	Time of recording	24, 290
4	Focus point ^{1,2}	89	11	Date of recording	24, 290
5	AF area brackets ¹	33	12	Current card slot	82
6	Frame number/total number of frames		13	Folder name	268
7	Image quality	77	14	File name	268

- 1 Displayed only if **Focus point** is selected for **Playback display options** (☞ 266) and selected photograph was taken using viewfinder.
- 2 If photograph was taken using **AF-S** or with single-servo autofocus selected during **AF-A**, display shows point where focus first locked. If photograph was taken using **AF-C** or with continuous-servo autofocus selected during **AF-A**, focus point is only displayed if option other than auto-area AF was selected for AF-area mode.




Highlights

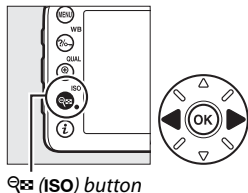



1 Image highlights*

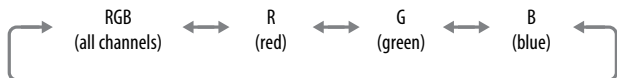
3 Current channel*

2 Folder number—frame
number 268

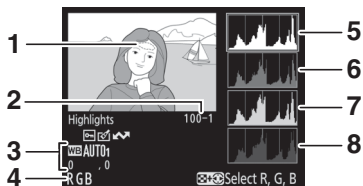
*Flashing areas indicate highlights (areas that may be overexposed) for the current channel. Hold  (ISO) button and press  or  to cycle through channels as follows:



 (ISO) button

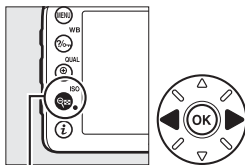


RGB Histogram



- | | |
|---|--|
| <p>1 Image highlights*</p> <p>2 Folder number—frame number268</p> <p>3 White balance..... 111
 Color temperature..... 117
 White balance fine-tuning..... 114
 Preset manual..... 120</p> <p>4 Current channel*</p> | <p>5 Histogram (RGB channel). In all histograms, horizontal axis gives pixel brightness, vertical axis number of pixels.</p> <p>6 Histogram (red channel)</p> <p>7 Histogram (green channel)</p> <p>8 Histogram (blue channel)</p> |
|---|--|

*Flashing areas indicate highlights (areas that may be overexposed) for the current channel. Hold **ISO** button and press **←** or **→** to cycle through channels as follows:



ISO button



Playback Zoom

To zoom in on the photograph when the histogram is displayed, press **Q (QUAL)**. Use the **Q (QUAL)** and **Q (ISO)** buttons to zoom in and out and scroll the image with the multi selector. The histogram will be updated to show only the data for the portion of the image visible in the monitor.



Histograms

Camera histograms are intended as a guide only and may differ from those displayed in imaging applications. Some sample histograms are shown below:

If the image contains objects with a wide range of brightnesses, the distribution of tones will be relatively even.



If the image is dark, tone distribution will be shifted to the left.

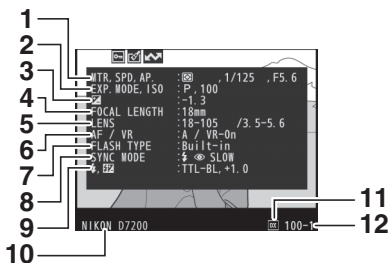


If the image is bright, tone distribution will be shifted to the right.



Increasing exposure compensation shifts the distribution of tones to the right, while decreasing exposure compensation shifts the distribution to the left. Histograms can provide a rough idea of overall exposure when bright ambient lighting makes it difficult to see photographs in the monitor.

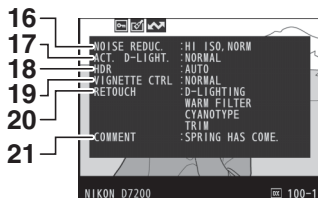
■ Shooting Data



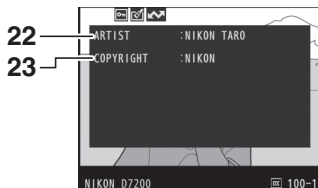
1 Metering	105	7 Flash type	144, 311
Shutter speed	53, 56	Commander mode	283
Aperture	54, 56	8 Flash mode	145, 147
2 Shooting mode	6	9 Flash control	149, 283, 313
ISO sensitivity ¹	99	Flash compensation	151
3 Exposure compensation	109	10 Camera name	
Optimal exposure tuning ²	278	11 Image area	73
4 Focal length	224, 310	12 Folder number—frame	
5 Lens data	224	number	268
6 Focus mode	83, 97		
Lens VR (vibration reduction) ³			



13 White balance	111	14 Color space	270
Color temperature	117	15 Picture Control ⁴	130
White balance fine-tuning	114		
Preset manual	120		



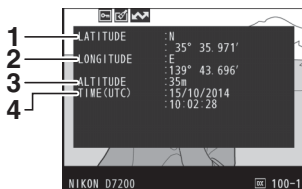
16	High ISO noise reduction.....	271	19	Vignette control.....	271
	Long exposure noise reduction.....	271	20	Retouch history.....	294
17	Active D-Lighting	139	21	Image comment	291
18	HDR strength	141			



22	Name of photographer ⁵	291	23	Copyright holder ⁵	291
----	---	-----	----	-------------------------------------	-----

- 1 Displayed in red if photo was taken with auto ISO sensitivity control on.
- 2 Displayed if Custom Setting b5 (**Fine-tune optimal exposure**, 278) has been set to a value other than zero for any metering method.
- 3 Displayed only if VR lens is attached.
- 4 Items displayed vary with Picture Control selected.
- 5 The fourth page of the shooting data is only displayed if copyright information was recorded with the photograph using the **Copyright information** option in the setup menu.

Location Data* (227)



1 Latitude

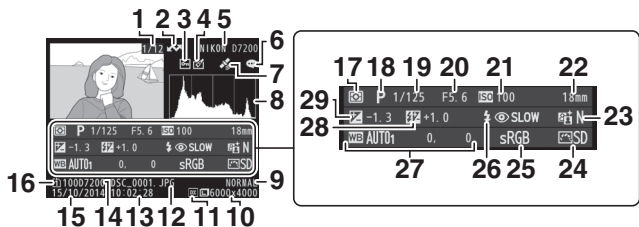
2 Longitude

3 Altitude

4 Coordinated Universal Time (UTC)

* Data for movies are for start of recording.


Overview Data

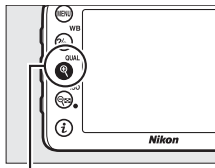


1 Frame number/total number of images	16 Current card slot82
2 Upload marking 263	17 Metering 105
3 Protect status 245	18 Shooting mode 6
4 Retouch indicator 294	19 Shutter speed 53, 56
5 Camera name	20 Aperture 54, 56
6 Image comment indicator 291	21 ISO sensitivity*99
7 Location data indicator 227	22 Focal length 224, 310
8 Histogram showing the distribution of tones in the image (238).	23 Active D-Lighting 139
9 Image quality77	24 Picture Control 130
10 Image size81	25 Color space 270
11 Image area73	26 Flash mode 145, 147
12 File name 268	27 White balance 111
13 Time of recording24, 290	Color temperature 117
14 Folder name 268	White balance fine-tuning ... 114
15 Date of recording24, 290	Preset manual 120
	28 Flash compensation 151
	Commander mode 283
	29 Exposure compensation 109






* Displayed in red if photo was taken with auto ISO sensitivity control on.

Taking a Closer Look: Playback Zoom






Press the  (**QUAL**) button to zoom in on the image displayed in full-frame playback. The following operations can be performed while zoom is in effect:



 (**QUAL**) button

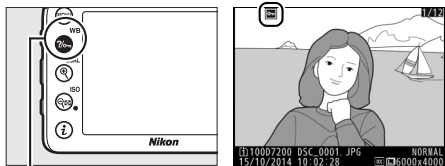
To	Use	Description
Zoom in or out	 (QUAL)/  (ISO)	Press  (QUAL) to zoom in to maximum of approximately 38× (large images in 24 × 16/DX format), 28× (medium images) or 19× (small images). Press  (ISO) to zoom out. While photo is zoomed in, use multi selector to view areas of image not visible in monitor. Keep multi selector pressed to scroll rapidly to other areas of frame. Navigation window is displayed when zoom ratio is altered; area currently visible in monitor is indicated by yellow border. Bar under navigation window shows zoom ratio; turns green at ratio of 1 : 1.
View other areas of image		



To	Use	Description
Select faces		<p>Faces detected during zoom are indicated by white borders in navigation window. Rotate sub-command dial to view other faces.</p> 
View other images		<p>Rotate main command dial to view same location in other photos at current zoom ratio. Playback zoom is cancelled when a movie is displayed.</p>
Return to shooting mode		<p>Press the  button or press the shutter-release button halfway to exit to shooting mode.</p>

Protecting Photographs from Deletion

In full-frame, zoom, thumbnail, and calendar playback, press the **⏏ (WB)** button to protect the current picture from accidental deletion. Protected files are marked with a **🔒** icon and can not be deleted using the **🗑 (FORMAT)** button or the **Delete** option in the playback menu. Note that protected images *will* be deleted when the memory card is formatted (📖 289). To remove protection from a picture so that it can be deleted, display or highlight it and press the **⏏ (WB)** button.




⏏ (WB) button

🔧 Removing Protection from All Images

To remove protection from all images in the folder or folders currently selected in the **Playback folder** menu, press the **⏏ (WB)** and **🗑 (FORMAT)** buttons together for about two seconds during playback.

Deleting Photographs

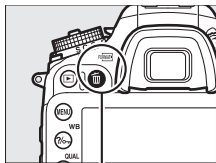
To delete the photograph displayed in full-frame playback or highlighted in the thumbnail list, press the  (FORMAT) button. To delete multiple selected photographs, all photographs taken on a selected date, or all photographs in the current playback folder, use the **Delete** option in the playback menu. Once deleted, photographs can not be recovered. Note that pictures that are protected or hidden can not be deleted.


Full-Frame, Thumbnail, and Calendar Playback

Press the  (FORMAT) button to delete the current photograph.



1 Press the (FORMAT) button.

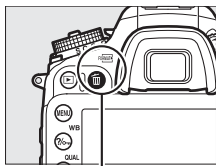
A confirmation dialog will be displayed.




 (FORMAT) button


2 Press the (FORMAT) button again.

To delete the photograph, press the  (FORMAT) button. To exit without deleting the photograph, press the  button.



 (FORMAT) button

Calendar Playback



During calendar playback, you can delete all photographs taken on a selected date by highlighting the date in the date list and pressing the  (FORMAT) button (📖 232).

See Also

The **After delete** option in the playback menu determines whether the next image or the previous image is displayed after an image is deleted (📖 267).

The Playback Menu



The **Delete** option in the playback menu contains the following options. Note that depending on the number of images, some time may be required for deletion.

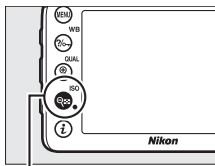
Option	Description
 Selected	Delete selected pictures.
 Select date	Delete all pictures taken on a selected date (📅 249).
ALL All	Delete all pictures in the folder currently selected for playback (📁 266). If two cards are inserted, you can select the card from which pictures will be deleted.




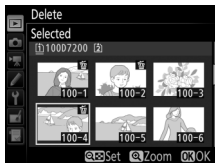
■ Selected: Deleting Selected Photographs

1 Select pictures.

Use the multi selector to highlight a picture and press the  (ISO) button to select or deselect. Selected pictures are marked by a  icon. Repeat as desired to select additional pictures.



 (ISO) button



2 Delete the selected pictures.

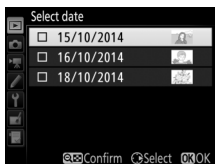
Press **OK**. A confirmation dialog will be displayed; highlight **Yes** and press **OK**.



■ ■ Select Date: Deleting Photographs Taken on a Selected Date

1 Select dates.

Highlight a date and press **▶** to select all pictures taken on the highlighted date. Selected dates are marked with a icon. Repeat as desired to select additional dates; to deselect a date, highlight it and press **◀**.



2 Delete the selected pictures.

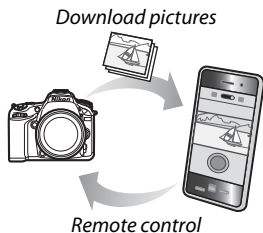
Press **OK**. A confirmation dialog will be displayed; highlight **Yes** and press **OK**.



Wi-Fi

What Wi-Fi Can Do for You

The camera can connect via Wi-Fi wireless networks to a compatible smart device (smartphone or tablet) running Nikon's dedicated Wireless Mobile Utility app (📖 263).



🔍 Installing the Wireless Mobile Utility App

1 Find the app.

On the smart device, connect to the Google Play service, the App Store, or another app marketplace and search for "Wireless Mobile Utility". For more information, see the instructions provided with the smart device.

2 Install the app.

Read the app description and install the app. A pdf manual for the Wireless Mobile Utility is available for download at the following URLs:

- **Android:** <http://nikonimglib.com/ManDL/WMAU/>
- **iOS:** <http://nikonimglib.com/ManDL/WMAU-ios/>



Android



iOS

Accessing the Camera

Before connecting via Wi-Fi (wireless LAN), install the Wireless Mobile Utility on your compatible Android or iOS smart device.

Android and iOS: Connecting via SSID

Enable Wi-Fi on the smart device before connecting. For details, see the documentation provided with the smart device.

1 Enable the camera's built-in Wi-Fi.

Highlight **Wi-Fi** in the setup menu and press **▶**. Highlight **Network connection** and press **▶**, then highlight **Enable** and press **OK**. Wait a few seconds for Wi-Fi to activate.

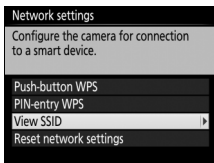


2 Display the camera SSID.

Highlight **Network settings** and press **▶**.



Highlight **View SSID** and press .



3 Select the camera SSID.

On the smart device, choose **Settings** > **Wi-Fi** and select the camera SSID to connect via Wi-Fi.


4 Launch the Wireless Mobile Utility.

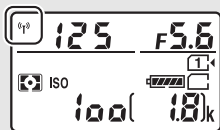
Launch the Wireless Mobile Utility on the smart device.

5 Enable wireless security.

The connection will initially be unprotected by passwords or other security features. Enable security using the Wireless Mobile Utility on the smart device (📖 257).

The Wi-Fi Display

While Wi-Fi is enabled, a  icon will flash in the display. The icon will stop flashing once a connection has been established and the camera is exchanging data with the smart device.



Control panel



Monitor

✔ Security

Although one of the benefits of a wireless-enabled device is that it allows others to freely connect for the wireless exchange of data anywhere within its range, the following may occur if security is not enabled:

- **Data theft:** Malicious third-parties may intercept wireless transmissions to steal user IDs, passwords, and other personal information.
- **Unauthorized access:** Unauthorized users may gain access to the network and alter data or perform other malicious actions. Note that due to the design of wireless networks, specialized attacks may allow unauthorized access even when security is enabled.

✔ Password Protection

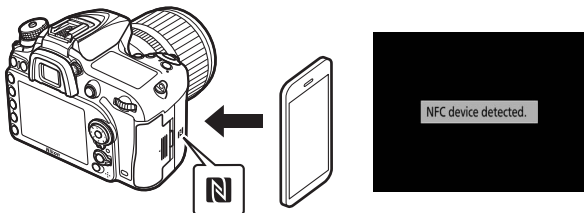
You may be prompted to enter a password the first time you connect after changing password settings.

Android: Connecting via NFC

If the smart device supports NFC (Near Field Communication), a Wi-Fi connection can be established simply by touching the camera **N** (N-Mark) logo to the smart device NFC antenna. Before connecting, enable NFC and Wi-Fi on the smart device as described in the documentation provided with the smart device.

1 Establish a Wi-Fi connection.

In viewfinder photography with the standby timer on, touch the camera **N** (N-Mark) logo to the smart device NFC antenna (for the location of the NFC antenna, see the documentation provided with the smart device). Maintain contact until the camera displays a message stating that an NFC device has been detected and a Wi-Fi connection has been established.



The Wireless Mobile Utility will launch automatically.

2 Enable wireless security.

The connection will initially be unprotected by passwords or other security features. Enable security using the Wireless Mobile Utility on the smart device (📖 257).

✔ Security

Although one of the benefits of a wireless-enabled device is that it allows others to freely connect for the wireless exchange of data anywhere within its range, the following may occur if security is not enabled:

- **Data theft:** Malicious third-parties may intercept wireless transmissions to steal user IDs, passwords, and other personal information.
- **Unauthorized access:** Unauthorized users may gain access to the network and alter data or perform other malicious actions. Note that due to the design of wireless networks, specialized attacks may allow unauthorized access even when security is enabled.

✔ NFC

NFC (Near Field Communication) is an international standard for short-range wireless communications technology.

✔ Wi-Fi

Connecting to a smart device via NFC automatically enables the **Wi-Fi > Network connection** option in the camera setup menu.

✔ No Connection

If you are unable to establish a connection using NFC as described above, connect using another method (☎ 251).

✔ Disabling NFC

The **NFC** option in the setup menu is used to turn NFC on and off. Select **Disable** to disable NFC connections.

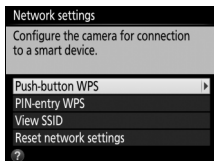
Android: Other Wi-Fi Connection Options

WPS can be used with compatible smart devices. Wireless security is enabled automatically.

■ **Push-Button WPS**

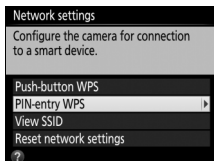
Adjust settings as follows to connect at the push of a button:

- **Camera:** Select **Wi-Fi > Network settings > Push-button WPS** in the setup menu.
- **Smart device:** Select **WPS button connection** in the **Wi-Fi settings** menu.



■ **PIN-Entry WPS**

To connect to a smart device using a PIN, select **Wi-Fi > Network settings > PIN-entry WPS** in the camera setup menu and enter the PIN displayed by the smart device.



Restoring Default Settings

To restore default network settings, select **Wi-Fi > Network settings > Reset network settings**. A confirmation dialog will be displayed; highlight **Yes** and press **OK** to restore default network settings.

🔪 **Terminating the Connection**

Wi-Fi can be disabled by:

- Selecting **Wi-Fi > Network connection > Disable** in the camera setup menu
- Starting movie recording
- Connecting an optional UT-1 communication unit
- Turning the camera off

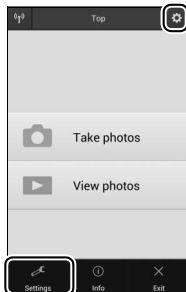
Wireless Security

Adjust security settings after establishing a Wi-Fi connection. In the case of WPS connections (☞ 256), security is enabled automatically; no further adjustments to settings are required.

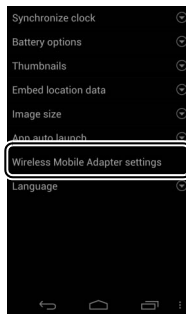
■ Android OS

1 Display Wireless Mobile Utility settings.

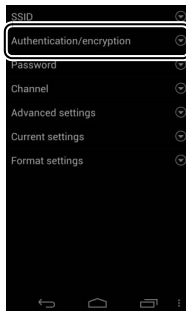
On the smart device, select the ⚙ icon at the top right corner of the display or open the settings menu in the Wireless Mobile Utility home display.



2 Select Wireless Mobile Adapter settings.

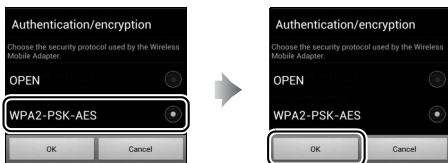


3 Select Authentication/encryption.

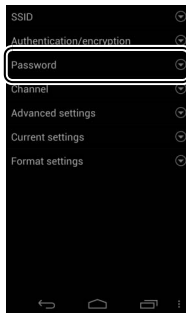


4 Select WPA2-PSK-AES.

Select **WPA2-PSK-AES** and select **OK**.



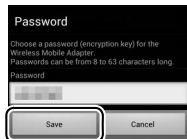
5 Select Password.




6 Enter a password.

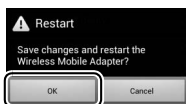
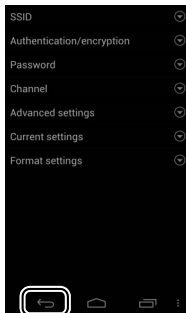
Enter a password and select **Save**.

Passwords may be from 8 to 63 characters long.



7 Enable wireless security.


Select . A confirmation dialog will be displayed; select **OK**.

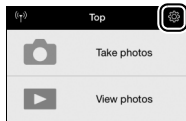


Viewing Wireless Security Settings

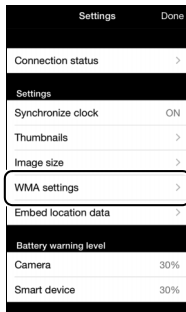
To view the current password and authentication/encryption settings, select **Current settings** in the **Wireless Mobile Adapter settings** menu.

1 Display Wireless Mobile Utility settings.

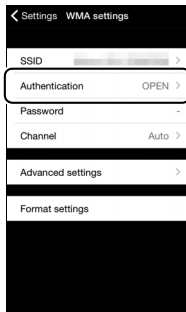
On the smart device, select the  icon in the Wireless Mobile Utility home display.



2 Select WMA settings.

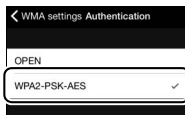


3 Select Authentication.

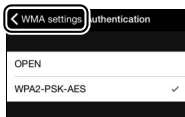


4 Select WPA2-PSK-AES.

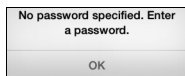
Select **WPA2-PSK-AES**.



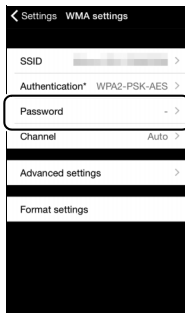
Select **WMA settings** to return to the WMA settings menu.



If you are prompted to enter a password, select **OK**.

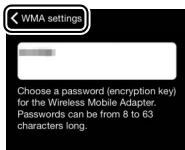


5 Select Password.



6 Enter a password.

Enter a password and select **WMA settings**. Passwords may be from 8 to 63 characters long.



7 Enable wireless security.

Select **Settings**. A confirmation dialog will be displayed; select **OK**.



The smart device will prompt you for this password the next time you connect to the camera via Wi-Fi.

Wi-Fi

Read the warnings on pages xx to xxii before using the Wi-Fi function. To disable Wi-Fi in settings in which its use is prohibited, select **Wi-Fi > Network connection > Disable** in the camera setup menu. Note that Eye-Fi cards can not be used while Wi-Fi is enabled and that the standby timer will not turn off while the Wireless Mobile Utility app on the smart device is communicating with the camera. If no data are exchanged for about 5 minutes, the standby timer will turn off. The camera Wi-Fi function is only available when a memory card is inserted and can not be used when a USB or HDMI cable is connected. To prevent loss of power while connected, charge the battery before enabling the network connection.

Selecting Pictures for Upload

Follow the steps below to select photos for upload to the smart device. Movies can not be selected for upload.

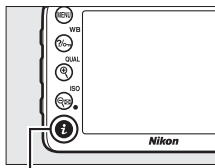
Selecting Individual Pictures for Upload

1 Select an image.

Display the image or highlight it in the thumbnail list in thumbnail or calendar playback.

2 Display playback options.


Press the **i** button to display playback options.



i button

3 Choose **Select to send to smart device/deselect**.

Highlight **Select to send to smart device/deselect** and press **OK**.


Pictures selected for upload are indicated by a  icon; to deselect, display or highlight the image and repeat Steps 2 and 3.





Selecting Multiple Pictures for Upload

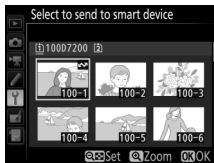
Follow the steps below to change the upload status of multiple pictures.

1 Choose **Select to send to smart device**.

Highlight **Wi-Fi** in the setup menu, then highlight **Select to send to smart device** and press .

2 Select pictures.


Use the multi selector to highlight pictures and press  (**ISO**) to select or deselect. Selected pictures are marked by a  icon.



3 Press .

Press  to complete the operation.



Selecting Pictures for Upload via NFC

If an NFC connection ( 254) is established during playback, the image currently displayed full frame or highlighted in the thumbnail list or calendar playback is automatically marked for upload.

1 Display or highlight the desired image.

Display the picture full frame or highlight it in the thumbnail list or calendar playback.

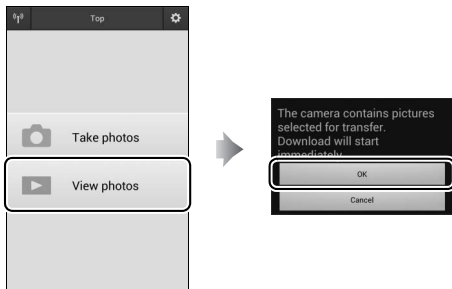
2 Connect.

Touch the camera  (N-Mark) logo to the smart device NFC antenna until the camera displays a message stating that an NFC device has been detected. The picture will be marked with a  icon to show that it has been selected for upload.

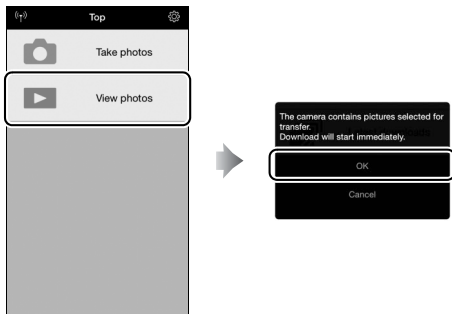
Downloading Selected Pictures to the Smart Device

To download the selected pictures to the smart device, establish a Wi-Fi connection with the camera (📖 251) and select **View photos** in the Wireless Mobile Utility. A confirmation dialog will be displayed; select **OK** to start download.

Android OS



iOS



Menu List

This section lists the options available in the camera menus. For more information, see the *Menu Guide*.

▶ The Playback Menu: *Managing Images*

Delete

Selected Delete multiple images (📖 248).

Select date

All

Playback folder

(defaults to **D7200**)

D7200 Choose a folder for playback.

All

Current

Hide image

Select/set Hide or reveal images. Hidden images are displayed only in the “Hide image” menu and cannot be played back.

Select date

Deselect all

Playback display options

Basic photo info Choose the information available in the playback photo information display (📖 234).

Focus point

Additional photo info

None (image only)

Highlights

RGB histogram

Shooting data

Overview

Copy image(s)

Select source
Select image(s)
Select destination folder
Copy image(s)?

Copy pictures from one memory card to another. This option is only available when two memory cards are inserted in the camera.

Image review(defaults to **Off**)

On
Off

Choose whether pictures are automatically displayed in the monitor immediately after shooting (☐ 230).

After delete(defaults to **Show next**)

Show next
Show previous
Continue as before

Choose the picture displayed after an image is deleted.

Rotate tall(defaults to **On**)

On
Off

Choose whether to rotate “tall” (portrait-orientation) pictures for display during playback (☐ 230).

Slide show

Start
Image type
Frame interval

View a slide show of the pictures in the current playback folder.

DPOF print order

Select/set
Deselect all

Select images for printing with a DPOF-compatible print service or printer, and choose the number of prints.

The Photo Shooting Menu: *Photo Shooting Options*

Reset photo shooting menu

Yes	Select Yes to restore photo shooting menu options to their default values.
No	

Storage folder

Select folder by number	Select the folder in which subsequent images will be stored.
Select folder from list	

File naming

File naming	Choose the three-letter prefix used in naming the image files in which photographs are stored. The default prefix is "DSC".
-------------	---

Role played by card in Slot 2

(defaults to **Overflow**)


Overflow	Choose the role played by the card in Slot 2 when two memory cards are inserted in the camera ( 82).
Backup	
RAW Slot 1 - JPEG Slot 2	

Image quality

(defaults to **JPEG normal**)


NEF (RAW) + JPEG fine	Choose a file format and compression ratio (image quality,  77).
NEF (RAW) + JPEG normal	
NEF (RAW) + JPEG basic	
NEF (RAW)	
JPEG fine	
JPEG normal	
JPEG basic	

Image size (defaults to Large)	
Large	Choose the image size, in pixels (□ 81).
Medium	
Small	
Image area (defaults to DX (24×16))	
DX (24×16)	Choose the image area (□ 73).
1.3× (18×12)	
JPEG compression (defaults to Size priority)	
Size priority	Choose a compression type for JPEG images (□ 80).
Optimal quality	
NEF (RAW) recording	
Type	Choose the type of compression and the bit depth for NEF (RAW) images (□ 80).
NEF (RAW) bit depth	
White balance (defaults to Auto)	
Auto	Match white balance to the light source (□ 111).
Incandescent	
Fluorescent	
Direct sunlight	
Flash	
Cloudy	
Shade	
Choose color temp.	
Preset manual	

Set Picture Control		(defaults to Standard)
Standard		Choose how new photos will be processed. Select according to the type of scene or your creative intent (📖 130).
Neutral		
Vivid		
Monochrome		
Portrait		
Landscape		
Flat		
Manage Picture Control		
Save/edit		Create custom Picture Controls (📖 135).
Rename		
Delete		
Load/save		
Color space		(defaults to sRGB)
sRGB		Choose a color space for photographs.
Adobe RGB		
Active D-Lighting		(defaults to Off (modes P, S, A, M , 📷, 📷, 📷, 📷, 📷, 📷, and 📷) or Auto (other modes))
Auto		Preserve details in highlights and shadows, creating photographs with natural contrast (📖 139).
Extra high		
High		
Normal		
Low		
Off		
HDR (high dynamic range)		
HDR mode		Preserve details in highlights and shadows when photographing high-contrast scenes (📖 141).
HDR strength		

Vignette control		(defaults to Normal)
High	Reduce the drop in brightness at the edges of photographs when using type G, E, and D lenses (PC lenses excluded). The effect is most noticeable at maximum aperture.	
Normal		
Low		
Off		
Auto distortion control		(defaults to Off)
On	Reduce barrel distortion when shooting with wide-angle lenses and to reduce pin-cushion distortion when shooting with long lenses.	
Off		
Long exposure NR		(defaults to Off)
On	Reduce “noise” (bright spots or fog) in photos taken at slow shutter speeds.	
Off		
High ISO NR		(defaults to Normal)
High	Reduce “noise” (randomly-spaced bright pixels) in photos taken at high ISO sensitivities.	
Normal		
Low		
Off		
ISO sensitivity settings		
ISO sensitivity	Adjust ISO sensitivity settings for photographs (□ 99, 102).	
Hi ISO command dial access		
Auto ISO sensitivity control		

Remote control mode (ML-L3)		(defaults to Off)
Delayed remote	Choose how the camera behaves when used with an ML-L3 remote control.	
Quick-response remote		
Remote mirror-up		
Off		
Multiple exposure		
Multiple exposure mode	Record two or three NEF (RAW) exposures as a single photograph (☞ 211).	
Number of shots		
Auto gain		
Interval timer shooting		
Start	Take photographs at the selected interval until the specified number of shots has been recorded (☞ 217).	
Start options		
Interval		
No. of intervals×shots/interval		
Exposure smoothing		

The Movie Shooting Menu: *Movie Shooting Options*

Reset movie shooting menu

Yes	Select Yes to restore movie shooting menu options to their default values.
No	

File naming

Choose the three-letter prefix used in naming the image files in which movies are stored. The default prefix is "DSC".

Destination

(defaults to **Slot 1**)

Slot 1	Choose the slot to which movies are recorded.
Slot 2	

Frame size/frame rate

(defaults to **1920×1080; 30p**)

1920×1080; 60p	Choose movie frame size (in pixels) and frame rate (□ 166).
1920×1080; 50p	
1920×1080; 30p	
1920×1080; 25p	
1920×1080; 24p	
1280×720; 60p	
1280×720; 50p	

Movie quality

(defaults to **Normal**)

High quality	Choose movie quality (□ 166).
Normal	

Microphone sensitivity

(defaults to **Auto sensitivity**)

Auto sensitivity	Turn the built-in or optional stereo microphones on or off or adjust microphone sensitivity.
Manual sensitivity	
Microphone off	

Frequency response	(defaults to Wide range)
Wide range	Choose the frequency response for the built-in microphone and optional stereo microphones.
Vocal range	
Wind noise reduction	(defaults to Off)
On	Choose whether to enable the built-in microphone's low-cut filter to reduce wind noise.
Off	
Image area	(defaults to DX (24×16))
DX (24×16)	Choose the image area (📖 168).
1.3× (18×12)	
White balance	(defaults to Same as photo settings)
Same as photo settings	Choose the white balance for movies (📖 112). Select Same as photo settings to use the option currently selected for photos.
Auto	
Incandescent	
Fluorescent	
Direct sunlight	
Cloudy	
Shade	
Choose color temp.	
Preset manual	

Set Picture Control (defaults to Same as photo settings)	
Same as photo settings	Choose a Picture Control for movies (☞ 130). Select Same as photo settings to use the option currently selected for photos.
Standard	
Neutral	
Vivid	
Monochrome	
Portrait	
Landscape	
Flat	
Manage Picture Control	
Save/edit	Create custom Picture Controls (☞ 132).
Rename	
Delete	
Load/save	
High ISO NR (defaults to Normal)	
High	Reduce “noise” (randomly-spaced bright pixels) in movies recorded at high ISO sensitivities.
Normal	
Low	
Off	
Movie ISO sensitivity settings	
ISO sensitivity (mode M)	Adjust ISO sensitivity settings for movies.
Auto ISO control (mode M)	
Maximum sensitivity	
Time-lapse photography	
Start	The camera automatically takes photos at selected intervals to create a silent time-lapse movie (☞ 171).
Interval	
Shooting time	
Exposure smoothing	

Custom Settings: Fine-Tuning Camera Settings

Reset custom settings

Yes	Select Yes to restore Custom Settings to their default values.
No	

a Autofocus

a1 AF-C priority selection (defaults to **Release**)

Release	When AF-C is selected for viewfinder photography, this option controls whether photographs can be taken whenever the shutter-release button is pressed (<i>release priority</i>) or only when the camera is in focus (<i>focus priority</i>).
Focus	

a2 AF-S priority selection (defaults to **Focus**)

Release	When AF-S is selected for viewfinder photography, this option controls whether photographs can be taken only when the camera is in focus (<i>focus priority</i>) or whenever the shutter-release button is pressed (<i>release priority</i>).
Focus	

a3 Focus tracking with lock-on (defaults to **3 (Normal)**)

5 (Long)	Choose how continuous-servo autofocus adjusts to sudden large changes in the distance to the subject (continuous-servo AF takes effect when AF-C is selected for focus mode during viewfinder photography or if the camera selects continuous-servo in AF-A mode).
4	
3 (Normal)	
2	
1 (Short)	
Off	

a4 AF activation (defaults to Shutter/AF-ON)	
Shutter/AF-ON	Choose whether the camera focuses when the shutter-release button is pressed halfway. If AF-ON only is selected, the camera will not focus when the shutter-release button is pressed halfway.
AF-ON only	
a5 Focus point illumination	
AF point illumination	Enable or disable viewfinder focus point illumination.
Manual focus mode	
a6 Focus point wrap-around (defaults to No wrap)	
Wrap	Choose whether viewfinder focus-point selection “wraps around” from one edge of the display to another.
No wrap	
a7 Number of focus points (defaults to 51 points)	
51 points	Choose the number of focus points available for manual focus-point selection in the viewfinder.
11 points	
a8 Store points by orientation (defaults to No)	
Yes	Choose whether the viewfinder stores the focus points for vertical and horizontal orientations separately.
No	
a9 Built-in AF-assist illuminator (defaults to On)	
On	Choose whether the built-in AF-assist illuminator lights to assist the focus operation when lighting is poor.
Off	

b Metering/exposure	
b1 ISO sensitivity step value	(defaults to 1/3 step)
1/3 step	Select the increments used when making adjustments to ISO sensitivity.
1/2 step	
b2 EV steps for exposure cntrl	(defaults to 1/3 step)
1/3 step	Select the increments used when making adjustments to shutter speed, aperture, exposure and flash compensation, and bracketing.
1/2 step	
b3 Easy exposure compensation	(defaults to Off)
On (Auto reset)	If On (Auto reset) or On is selected, exposure compensation can be adjusted in modes P and S by rotating the sub-command dial or in mode A by rotating the main command dial.
On	
Off	
b4 Center-weighted area	(defaults to ϕ 8 mm)
ϕ 6 mm	Choose the size of the area given the most weight in center-weighted metering. If a non-CPU lens is attached, the size of the area is fixed at 8 mm.
ϕ 8 mm	
ϕ 10 mm	
ϕ 13 mm	
Average	
b5 Fine-tune optimal exposure	(defaults to No)
Yes	Fine-tune exposure for each metering method. Higher values produce brighter exposures, lower values darker exposures.
No	

c Timers/AE lock

c1 Shutter-release button AE-L

(defaults to **Off**)

On
Off

Choose whether exposure locks when the shutter-release button is pressed halfway.

c2 Standby timer

(defaults to **6 s**)

4 s
6 s
10 s
30 s
1 min
5 min
10 min
30 min
No limit

Choose how long the camera continues to meter exposure when no operations are performed (□ 37).

c3 Self-timer

Self-timer delay
Number of shots
Interval between shots

Choose the length of the shutter release delay, the number of shots taken, and the interval between shots in self-timer mode.

c4 Monitor off delay

Playback
Menus
Information display
Image review
Live view

Choose how long the monitor remains on when no operations are performed.

c5 Remote on duration (ML-L3)

(defaults to **1 min**)

1 min
5 min
10 min
15 min

Select the length of time the camera will wait for a signal from the remote before cancelling remote control mode (□ 156).

d Shooting/display

d1 Beep

Volume Choose the pitch and volume of the beep.
Pitch

d2 Continuous low-speed (defaults to 3 fps)

6 fps Choose the maximum frame advance rate in **CL** mode (note that the frame advance rate in live view will not exceed 3.7 fps even when values of 4 fps or faster are selected).
5 fps
4 fps
3 fps
2 fps
1 fps

d3 Max. continuous release (defaults to 100)

1–100 Choose the maximum number of shots that can be taken in a single burst in continuous release mode.

d4 Exposure delay mode (defaults to Off)

3 s In situations where the slightest camera movement can blur pictures, select **1 s**, **2 s**, or **3 s** to delay shutter release until approximately one, two, or three seconds after the mirror is raised.
2 s
1 s
Off

d5 Flash warning (defaults to On)

On If **On** is selected, the flash-ready indicator (⚡) will blink if the flash is required to ensure optimal exposure.
Off

d6 File number sequence (defaults to On)

On Choose how the camera assigns file numbers.
Off
Reset

d7 Viewfinder grid display (defaults to Off)

On Choose whether to display a framing grid in the viewfinder.
Off

d8 Easy ISO (defaults to Off)	
On	If On is selected, ISO sensitivity can be set in modes P and S by rotating the sub-command dial or in mode A by rotating the main command dial.
Off	
d9 Information display (defaults to Auto)	
Auto	Change the appearance of the information display (☐ 185) for conditions in which the monitor is hard to read (for example, when lighting is too bright or too dark).
Manual	
d10 LCD illumination (defaults to Off)	
On	Choose whether the control panel is illuminated while the standby timer is active.
Off	
d11 MB-D15 battery type (defaults to LR6 (AA alkaline))	
LR6 (AA alkaline)	To ensure that the camera functions as expected when the optional MB-D15 battery pack is used with AA batteries, match the option selected in this menu to the type of batteries inserted in the battery pack. There is no need to adjust this option when using EN-EL15b/EN-EL15a/EN-EL15 batteries.
HR6 (AA Ni-MH)	
FR6 (AA lithium)	
d12 Battery order (defaults to Use MB-D15 batteries first)	
Use MB-D15 batteries first	Choose whether the battery in the camera or the batteries in the battery pack are used first when an optional MB-D15 battery pack is attached.
Use camera battery first	

e Bracketing/flash

e1 Flash sync speed

(defaults to **1/250 s**)

1/320 s (Auto FP)

Choose a flash sync speed.

1/250 s (Auto FP)

1/250 s

1/200 s

1/160 s

1/125 s

1/100 s

1/80 s

1/60 s

Fixing Shutter Speed at the Flash Sync Speed Limit

To fix shutter speed at the sync speed limit in mode **S** or **M**, select the next shutter speed after the slowest possible shutter speed (30 s or -). An **X** (flash sync indicator) will be displayed in the viewfinder and control panel.

Auto FP High-Speed Sync

Selecting an "Auto FP" option allows compatible flash units to be used at the highest shutter speed supported by the camera (□ 314). Auto FP high-speed sync is enabled automatically at shutter speeds faster than the chosen flash sync speed ($1/320$ s or $1/250$ s depending on the option selected), allowing wider apertures for reduced depth of field even in daylight. If the shutter-speed displays in the control panel and viewfinder show a value equal to the flash sync speed in modes **P** and **A**, auto FP high-speed sync will still be activated if the actual shutter speed is even slightly faster.

e2 Flash shutter speed	(defaults to 1/60 s)
1/60 s	Choose the slowest shutter available when the flash is used in modes P and A .
1/30 s	
1/15 s	
1/8 s	
1/4 s	
1/2 s	
1 s	
2 s	
4 s	
8 s	
15 s	
30 s	
e3 Flash cntrl for built-in flash	(defaults to TTL)
TTL	Choose the flash control mode for the built-in flash.
Manual	
Repeating flash	
Commander mode	
e3 Optional flash	(defaults to TTL)
TTL	Choose the flash control mode for optional flash units.
Manual	
Commander mode	
e4 Exposure comp. for flash	(defaults to Entire frame)
Entire frame	Choose how the camera adjusts flash level when exposure compensation is used.
Background only	

e5 Modeling flash (defaults to On)	
On	Choose whether the built-in flash unit and optional CLS-compatible flash units (□ 144, 311) emit a modeling flash when the camera Pv button is pressed during viewfinder photography (□ 55).
Off	
e6 Auto bracketing set (defaults to AE & flash)	
AE & flash	Choose the setting or settings bracketed when auto bracketing is in effect (□ 197).
AE only	
Flash only	
WB bracketing	
ADL bracketing	
e7 Bracketing order (defaults to MTR > under > over)	
MTR > under > over	Choose the bracketing order for exposure, flash, and white balance bracketing.
Under > MTR > over	
f Controls	
f1 OK button	
Shooting mode	Choose the roles assigned to the OK button during viewfinder photography, playback, and live view.
Playback mode	
Live view	
f2 Assign Fn button	
Press	Choose the role played by the Fn button, either by itself (Press) or when used in combination with the command dials (Press + command dials).
Press + command dials	

f3 Assign preview button

Press

Press + command dials

Choose the role played by the **Pv** button, either by itself (**Press**) or when used in combination with the command dials (**Press + command dials**).

f4 Assign AE-L/AF-L button

Press

Press + command dials

Choose the role played by the ^{AE-L}/_{AF-L} **AE-L/AF-L** button, either by itself (**Press**) or when used in combination with the command dials (**Press + command dials**).

f5 Customize command dials

Reverse rotation

Change main/sub

Aperture setting

Menus and playback

Sub-dial frame advance








Choose the roles played by the main and sub-command dials.

f6 Release button to use dial(defaults to **No**)


Yes

No

Selecting **Yes** allows adjustments that are normally made by holding a button and rotating a command dial to be made by rotating the command dial after the button is released. Setting ends when the button is pressed again, the shutter-release button is pressed halfway, or the standby timer expires.

f7 Slot empty release lock (defaults to Enable release)	
Release locked	Choose whether the shutter can be released when no memory card is inserted.
Enable release	
f8 Reverse indicators (defaults to )	
	If  (-0+) is selected, the exposure indicators in the control panel, viewfinder, and information display are displayed with negative values on the left and positive values on the right. Select  (+0-) to display positive values on the left and negative values on the right.
	
f9 Assign movie record button	
Press + command dials	Choose the role played by the movie-record button and command dials during viewfinder and photo live view.
f10 Assign MB-D15  button (defaults to AE/AF lock)	
AE/AF lock	Choose the function assigned to the  AE-L/AF-L button on the optional MB-D15 battery pack.
AE lock only	
AE lock (Hold)	
AF lock only	
AF-ON	
FV lock	
Same as camera Fn button	


f11 Assign remote (WR) Fn button(defaults to **None**)

Preview	Choose the role played by the Fn button on the optional wireless remote controller.
FV lock	
AE/AF lock	
AE lock only	
AE lock (Hold)	
AF lock only	
Flash off	
+ NEF (RAW)	
Live view	
Same as camera Fn button	
Same as camera Pv button	
Same as camera  button	
None	

g Movie


g1 Assign Fn button

Press

Choose the role played by the **Fn** button when  is selected with the live view selector in live view.


g2 Assign preview button

Press

Choose the role played by the **Pv** button when  is selected with the live view selector in live view.

g3 Assign AE-L/AF-L button

Press



Choose the role played by the ^{AE-L}/_{AF-L} **AE-L/AF-L** button when  is selected with the live view selector in live view.

g4 Assign shutter button


(defaults to **Take photos**)

Take photos

Record movies

Choose the role played by the shutter-release button when  is selected with the live view selector. If **Record movies** is selected, pressing the button halfway starts live view. You can then press the shutter-release button halfway to focus (autofocus mode only) and press all the way down to start or end movie recording. To end live view, press the  button.

g4: Assign Shutter Button > Record Movies


To use the shutter-release button for purposes other than movie recording, rotate the live view selector to .

The Setup Menu: *Camera Setup*


Format memory card

Slot 1	To begin formatting, choose a memory card slot and select Yes . <i>Note that formatting permanently deletes all pictures and other data on the card in the selected slot.</i> Before formatting, be sure to make backup copies as required.
Slot 2	

Save user settings

Save to U1	Assign frequently-used settings to the U1 and U2 positions on the mode dial ( 63).
Save to U2	

Reset user settings

Reset U1	To reset settings for U1 or U2 to default values ( 65).
Reset U2	





Monitor brightness


(defaults to 0)

-5 - +5	Adjust the brightness of the menu, playback, and information displays.
---------	--

Formatting Memory Cards

Do not turn the camera off or remove the battery or memory cards during formatting.

In addition to the **Format memory card** option in the setup menu, memory cards can be formatted using the  ( **FORMAT**) and  ( **FORMAT**) buttons: keep both buttons pressed simultaneously until formatting indicators are displayed and then press the buttons again to format the card. If two memory cards are inserted when the buttons are first pressed, the card to be formatted will be shown by a flashing icon. Rotate the main command dial to choose a different slot.

Monitor color balance		(defaults to 0)
	Adjust monitor color balance.	
Clean image sensor		
Clean now	Vibrate the image sensor to remove	
Clean at startup/shutdown	dust (☞ 321).	
Lock mirror up for cleaning		
Start	Lock the mirror up so that dust can be removed from the image sensor with a blower. Not available when the battery is low (☞  or lower).	
Image Dust Off ref photo		
Start	Acquire reference data for the Image	
Clean sensor and then start	Dust Off option in Capture NX-D (☞ ii).	
Flicker reduction		(defaults to Auto)
Auto	Reduce flicker and banding when	
50 Hz	shooting under fluorescent or mercury-	
60 Hz	vapor lighting during live view.	
Time zone and date		
Time zone	Change time zones, set the camera	
Date and time	clock, choose the date display order,	
Date format	and turn daylight saving time on or off.	
Daylight saving time		
Language		
See page 357.	Choose a language for camera menus and messages.	
Auto image rotation		(defaults to On)
On	Choose whether to record camera	
Off	orientation when taking photographs.	

Battery info

View information on the battery currently inserted in the camera or in an optional MB-D15 battery pack.

Image comment

Attach comment

Input comment

Add a comment to new photographs as they are taken. Comments can be viewed as metadata in ViewNX-i or Capture NX-D (☐ ii).

Copyright information

Attach copyright information

Artist

Copyright

Add copyright information to new photographs as they are taken. Copyright information can be viewed as metadata in ViewNX-i or in Capture NX-D (☐ ii).

Save/load settings

Save settings

Load settings

Save camera settings to or load camera settings from a memory card. Settings files can be shared with other D7200 cameras.

Virtual horizon

View a virtual horizon with a roll display based on information from the camera tilt sensor.


Non-CPU lens data

Lens number

Focal length (mm)

Maximum aperture

Record the focal length and maximum aperture of non-CPU lenses, allowing them to be used with functions normally reserved for CPU lenses (☐ 224).

AF fine-tune	
AF fine-tune (On/Off)	Fine-tune focus for different lens types. AF tuning is not recommended in most situations and may interfere with normal focus; use only when required.
Saved value	
Default	
List saved values	
HDMI	
Output resolution	Choose an output resolution or enable the camera for remote control from devices that support HDMI-CEC.
Device control	
Advanced	
Location data	
Standby timer	Adjust settings for optional GP-1 and GP-1A GPS units.
Position	
Set clock from satellite	
Wi-Fi	
Network connection	Adjust Wi-Fi (wireless LAN) settings for connection to an Android or iOS smart device, or select pictures for upload to a smart device (☞ 251).
Network settings	
Select to send to smart device	
NFC (defaults to Enable)	
Enable	If Enable is selected, wireless connections can be established simply by touching the camera  (N-Mark) logo to the NFC antennas on compatible smart devices (☞ 254).
Disable	

Network

Choose hardware	Adjust ftp and network settings for Ethernet and wireless LANs when an optional UT-1 communications unit (□ 319) is connected.
Network settings	
Options	

Eye-Fi upload

Slot 1	Upload pictures to a preselected destination. This option is displayed only when a supported Eye-Fi card is inserted.
Slot 2	

Conformity marking

View a selection of the standards with which the camera complies.

Firmware version

View the current camera firmware version.

The Retouch Menu: *Creating Retouched Copies*

D-Lighting

Brighten shadows. Choose for dark or backlit photographs.

Red-eye correction

Correct “red-eye” in photos taken with a flash.

Trim

Create a cropped copy of the selected photograph (📄 298).

Monochrome

Black-and-white

Sepia

Cyanotype

Copy photographs in **Black-and-white**, **Sepia**, or **Cyanotype** (blue and white monochrome).

Filter effects

Skylight

Warm filter


Cross screen

Soft

Create the effects of the following filters:

- **Skylight:** A skylight filter effect
- **Warm filter:** A warm tone filter effect
- **Cross screen:** Adds starburst effects to light sources
- **Soft:** A soft filter effect

Image overlay

Image overlay combines two existing NEF (RAW) photographs to create a single picture that is saved separately from the originals (📄 299). **Image overlay** can only be selected by pressing **MENU** and selecting  tab.

NEF (RAW) processing

Create JPEG copies of NEF (RAW) photographs (☐ 302).

Resize

Select image

Choose destination

Choose size

Create small copies of selected photographs.

Quick retouch

Create copies with enhanced saturation and contrast.

Straighten

Create straightened copies. Copies can be straightened by up to 5° in increments of approximately 0.25°.

Distortion control

Auto

Manual

Create copies with reduced peripheral distortion. Use to reduce barrel distortion in photos taken with wide-angle lenses or pin-cushion distortion in photos taken with telephoto lenses. Select **Auto** to let the camera correct distortion automatically.

Fisheye

Create copies that appear to have been taken with a fisheye lens.

Color outline

Create an outline copy of a photograph to use as a base for painting.

Color sketch

Create a copy of a photograph that resembles a sketch made with colored pencils.




Perspective control

Create copies that reduce the effects of perspective taken from the base of a tall object.

Miniature effect

Create a copy that appears to be a photo of a diorama. Use the multi selector to choose the position and orientation of the area in focus. Works best with photos taken from a high vantage point.


Selective color

Create a copy in which only selected hues appear in color. Position the cursor over objects with desired colors and press the  **AE-L/AF-L** button. The selected colors (maximum three) appear in the frames at the top of the display; rotate the main command dial to highlight a frame and press  or  to increase or decrease the range of hues selected.


Edit movie

Choose start/end point

Save selected frame

Trim footage to create edited copies of movies or save selected frames as JPEG stills ( 179).

Side-by-side comparison

Compare retouched copies to the original photographs. **Side-by-side comparison** is only available if the retouch menu is displayed by pressing  and selecting **Retouch** in full-frame playback when a retouched image or original is displayed.

My Menu/ Recent Settings

Add items

PLAYBACK MENU	Create a custom menu of up to 20 items selected from the playback, photo shooting, movie shooting, Custom Setting, setup, and retouch menus.
PHOTO SHOOTING MENU	
MOVIE SHOOTING MENU	
CUSTOM SETTING MENU	
SETUP MENU	
RETOUCH MENU	

Remove items

Delete items from My Menu.

Rank items

Rank items in My Menu.

Choose tab

(defaults to **MY MENU**)








MY MENU	Choose the menu displayed in the “My Menu/Recent Settings” tab. Select RECENT SETTINGS to display a menu listing the 20 most recently-used settings.
RECENT SETTINGS	

Retouch Menu Options


This section details retouch menu options.

Trim

Create a cropped copy of the selected photograph. The selected photograph is displayed with the selected crop shown in yellow; create a cropped copy as described in the following table.

To	Use	Description
Reduce size of crop	 (ISO)	Press  (ISO) to reduce the size of the crop.
Increase size of crop	 (QUAL)	Press  (QUAL) to increase the size of the crop.
Change crop aspect ratio		Rotate the main command dial to choose the aspect ratio.
Position crop		Use multi selector to position the crop. Press and hold to move the crop rapidly to the desired position.
Create copy		Save the current crop as a separate file.

Trim: Image Quality and Size

Copies created from NEF (RAW) or NEF (RAW) + JPEG photos have an image quality ( 77) of JPEG fine; cropped copies created from JPEG photos have the same image quality as the original. The size of the copy varies with crop size and aspect ratio and appears at upper left in the crop display.

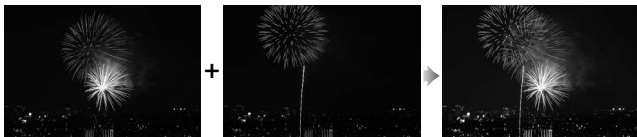


Viewing Cropped Copies

Playback zoom may not be available when cropped copies are displayed.

Image Overlay

Image overlay combines two existing NEF (RAW) photographs to create a single picture that is saved separately from the originals; the results, which make use of RAW data from the camera image sensor, are noticeably better than overlays created in an imaging application. The new picture is saved at current image quality and size settings; before creating an overlay, set image quality and size (☐ 77, 81; all options are available). To create a NEF (RAW) copy, choose an image quality of **NEF (RAW)**.



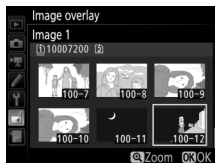
1 Select Image overlay.

Highlight **Image overlay** in the retouch menu and press \odot . The dialog shown at right will be displayed, with **Image 1** highlighted; press \odot to display a picture selection dialog listing only NEF (RAW) images created with this camera.



2 Select the first image.

Use the multi selector to highlight the first photograph in the overlay. To view the highlighted photograph full frame, press and hold the \mathcal{Q} (**QUAL**) button. Press \odot to select the highlighted photograph and return to the preview display.

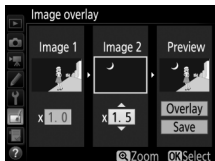


3 Select the second image.

The selected image will appear as **Image 1**. Highlight **Image 2** and press **OK**, then select the second photo as described in Step 2.

4 Adjust gain.

Highlight **Image 1** or **Image 2** and optimize exposure for the overlay by pressing **▲** or **▼** to select gain from values between 0.1 and 2.0. Repeat for the second image. The default value is 1.0; select 0.5 to halve gain or 2.0 to double it. The effects are visible in the **Preview** column.



5 Preview the overlay.

To preview the composition as shown at right, press **◀** or **▶** to place the cursor in the **Preview** column, then press **▲** or **▼** to highlight **Overlay** and press **OK** (note that colors and brightness in the preview may differ from the final image). To save the overlay without displaying a preview, select **Save**. To return to Step 4 and select new photos or adjust gain, press **ISO**.



6 Save the overlay.

Press **OK** while the preview is displayed to save the overlay. After an overlay is created, the resulting image will be displayed full-frame in the monitor.



Image Overlay

Only NEF (RAW) photographs with the same image area and bit depth can be combined.

The overlay has the same photo info (including date of recording, metering, shutter speed, aperture, shooting mode, exposure compensation, focal length, and image orientation), and values for white balance and Picture Control as the photograph selected for **Image 1**. The current image comment is appended to the overlay when it is saved; copyright information, however, is not copied.

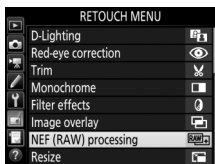
Overlays saved in NEF (RAW) format use the compression selected for **Type** in the **NEF (RAW) recording** menu and have the same bit depth as the original images; JPEG overlays are saved using size-priority compression.

NEF (RAW) Processing

Create JPEG copies of NEF (RAW) photographs.

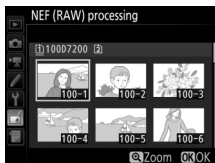
1 Select NEF (RAW) processing.

Highlight **NEF (RAW) processing** in the retouch menu and press **OK** to display a picture selection dialog listing only NEF (RAW) images created with this camera.



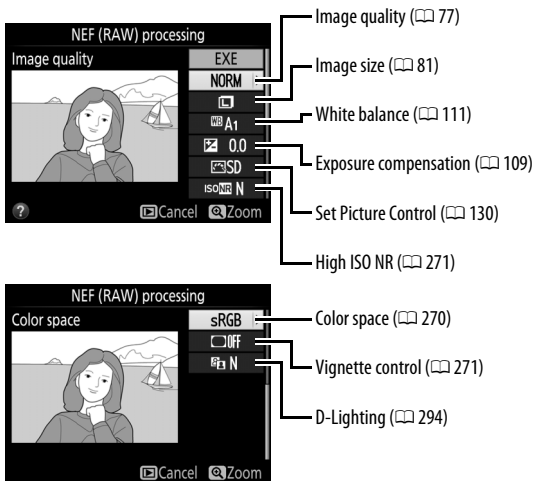
2 Select a photograph.

Use the multi selector to highlight a photograph (to view the highlighted photograph full frame, press and hold the **QUAL** button). Press **OK** to select the highlighted photograph and proceed to the next step.



3 Choose settings for the JPEG copy.

Adjust the settings listed below. Note that white balance and vignette control are not available with multiple exposures or pictures created with image overlay and that exposure compensation can only be set to values between -2 and $+2$ EV.



4 Copy the photograph.

Highlight **EXE** and press **OK** to create a JPEG copy of the selected photograph (to exit without copying the photograph, press the **MENU** button).



Technical Notes

Read this chapter for information on compatible accessories, cleaning and storing the camera, and what to do if an error message is displayed or you encounter problems using the camera.

Compatible Lenses

Lens/accessory	Camera setting		Focus mode		Shooting mode		Metering system	
	AF	M (with electronic rangefinder) ¹	P S	A M	☒ ²		☒ ³	
					3D	Color	☒ ⁴	
CPU lenses ⁵	Type G, E, or D AF NIKKOR ⁶ AF-S, AF-I NIKKOR	✓	✓	✓	✓	✓	—	✓ ⁷
	PC-E NIKKOR series ⁸	—	✓ ⁹	✓ ⁹	✓ ⁹	✓ ⁹	—	✓ ^{7,9}
	PC Micro 85mm f/2.8D ¹⁰	—	✓ ⁹	—	✓ ¹¹	✓	—	✓ ^{7,9}
	AF-S / AF-I Teleconverter ¹²	✓	✓	✓	✓	✓	—	✓ ⁷
	Other AF NIKKOR (except lenses for F3AF)	✓ ¹³	✓ ¹³	✓	✓	—	✓	✓ ⁷
	AI-P NIKKOR	—	✓ ¹⁴	✓	✓	—	✓	✓ ⁷

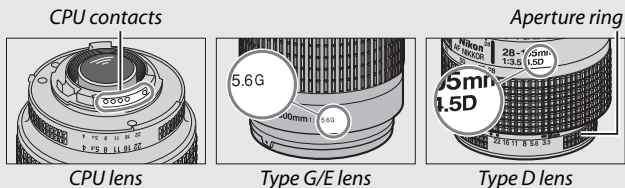
Camera setting Lens/accessory		Focus mode		Shooting mode		Metering system		
		AF	M (with electronic rangefinder) ¹	P S	A M	☒ ²		☑ ³
						3D	Color	☐ ⁴
Non-CPU lenses ¹⁵	AI-, AI-modified NIKKOR or Nikon Series E lenses ¹⁶	—	✓ ¹⁴	—	✓ ¹⁷	—	✓ ¹⁸	✓ ¹⁹
	Medical-NIKKOR 120mm f/4	—	✓	—	✓ ²⁰	—	—	—
	Reflex-NIKKOR	—	—	—	✓ ¹⁷	—	—	✓ ¹⁹
	PC-NIKKOR	—	✓ ⁹	—	✓ ²¹	—	—	✓
	AI-type Teleconverter ²²	—	✓ ²³	—	✓ ¹⁷	—	✓ ¹⁸	✓ ¹⁹
	PB-6 Bellows Focusing Attachment ²⁴	—	✓ ²³	—	✓ ²⁵	—	—	✓
	Auto extension rings (PK-series 11A, 12, or 13; PN-11)	—	✓ ²³	—	✓ ¹⁷	—	—	✓

- 1 Manual focus available with all lenses.
- 2 Matrix.
- 3 Center-weighted.
- 4 Spot.
- 5 IX-NIKKOR lenses can not be used.
- 6 Vibration Reduction (VR) supported with VR lenses.
- 7 Spot metering meters selected focus point (☐ 105).
- 8 The tilt knob for the PC-E NIKKOR 24mm f/3.5D ED may contact the camera body when the lens is revolved.
- 9 Can not be used with shifting or tilting.
- 10 The camera's exposure metering and flash control systems do not work properly when shifting and/or tilting the lens, or when an aperture other than the maximum aperture is used.
- 11 Manual shooting mode only.

- 12 Can be used with AF-S and AF-I lenses only (□ 307). For information on the focus points available for autofocus and electronic rangefinding, see page 307.
 - 13 When focusing at minimum focus distance with AF 80–200mm f/2.8, AF 35–70mm f/2.8, AF 28–85mm f/3.5–4.5 <New>, or AF 28–85mm f/3.5–4.5 lens at maximum zoom, in-focus indicator (●) may be displayed when image on matte screen in viewfinder is not in focus. Adjust focus manually until image in viewfinder is in focus.
 - 14 With maximum aperture of f/5.6 or faster.
 - 15 Some lenses can not be used (see page 308).
 - 16 Range of rotation for AI 80–200mm f/2.8 ED tripod mount is limited by camera body. Filters can not be exchanged while AI 200–400mm f/4 ED is mounted on camera.
 - 17 If maximum aperture is specified using **Non-CPU lens data** (□ 225), aperture value will be displayed in viewfinder and control panel.
 - 18 Can be used only if lens focal length and maximum aperture are specified using **Non-CPU lens data** (□ 225). Use spot or center-weighted metering if desired results are not achieved.
 - 19 For improved precision, specify lens focal length and maximum aperture using **Non-CPU lens data** (□ 225).
 - 20 Can be used in mode **M** at shutter speeds slower than flash sync speed by one step or more.
 - 21 Exposure determined by presetting lens aperture. In mode **A**, preset aperture using lens aperture ring before performing AE lock and shifting lens. In mode **M**, preset aperture using lens aperture ring and determine exposure before shifting lens.
 - 22 Exposure compensation required when used with AI 28–85mm f/3.5–4.5, AI 35–105mm f/3.5–4.5, AI 35–135mm f/3.5–4.5, or AF-S 80–200mm f/2.8D.
 - 23 With maximum effective aperture of f/5.6 or faster.
 - 24 Requires PK-12 or PK-13 auto extension ring. PB-6D may be required depending on camera orientation.
 - 25 Use preset aperture. In mode **A**, set aperture using focusing attachment before determining exposure and taking photograph.
- PF-4 Reprocopy Outfit requires PA-4 Camera Holder.
 - With some lenses, noise in the form of lines may appear during autofocus at high ISO sensitivities. Use manual focus or focus lock.

Recognizing CPU and Type G, E, and D Lenses

CPU lenses (particularly types G, E, and D) are recommended, but note that IX-NIKKOR lenses can not be used. CPU lenses can be identified by the presence of CPU contacts, type G, E, and D lenses by a letter on the lens barrel. Type G and E lenses are not equipped with a lens aperture ring.



AF-S/AF-I Teleconverters

If the combined aperture when the camera is used with an AF-S/AF-I teleconverter is slower than $f/5.6$ but is equal to or faster than $f/8$, autofocus and electronic rangefinding will be available only with the center focus point and the camera may be unable to focus on dark or low-contrast subjects. Single point AF is used when 3D-tracking or auto-area AF is selected for AF-area mode (□ 86). Autofocus is not available if teleconverters are used with the AF-S VR Micro-Nikkor 105mm $f/2.8G$ IF-ED. If TC-17E II, TC-20E, TC-20E II, or TC-20E III teleconverters are used with the AF-S NIKKOR 300mm $f/4E$ PF ED VR, autofocus is available only in AF-S mode.



Lens f-number

The f-number given in lens names is the maximum aperture of the lens.

Compatible Non-CPU Lenses

Non-CPU lens data (📖 225) can be used to enable many of the features available with CPU lenses, including color matrix metering; if no data are provided, center-weighted metering will be used in place of color matrix metering, while if the maximum aperture is not provided, the camera aperture display will show the number of stops from maximum aperture and the actual aperture value must be read off the lens aperture ring.

Incompatible Accessories and Non-CPU Lenses

The following can NOT be used with the D7200:

- TC-16A AF teleconverter
- Non-AI lenses
- Lenses that require the AU-1 focusing unit (400mm f/4.5, 600mm f/5.6, 800mm f/8, 1200mm f/11)
- Fisheye (6mm f/5.6, 7.5mm f/5.6, 8mm f/8, OP 10mm f/5.6)
- 2.1cm f/4
- Extension Ring K2
- 180–600mm f/8 ED (serial numbers 174041–174180)
- 360–1200mm f/11 ED (serial numbers 174031–174127)
- 200–600mm f/9.5 (serial numbers 280001–300490)
- AF lenses for the F3AF (AF 80mm f/2.8, AF 200mm f/3.5 ED, AF Teleconverter TC-16)
- PC 28mm f/4 (serial number 180900 or earlier)
- PC 35mm f/2.8 (serial numbers 851001–906200)
- PC 35mm f/3.5 (old type)
- Reflex 1000mm f/6.3 (old type)
- Reflex 1000mm f/11 (serial numbers 142361–143000)
- Reflex 2000mm f/11 (serial numbers 200111–200310)

Red-Eye Reduction

Lenses that block the subject's view of the red-eye reduction lamp may interfere with red-eye reduction.

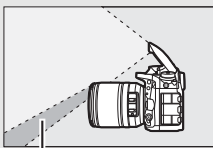
AF-Assist Illumination

The AF-assist illuminator has a range of about 0.5–3.0 m (1 ft 8 in.–9 ft 10 in.); when using the illuminator, use a lens with a focal length of 18–200 mm. Some lenses may block the illuminator at certain focus distances. Remove lens hoods when using the illuminator. More information on lenses that can be used with the AF-assist illuminator may be found in the camera *Menu Guide*, which is available for download from the following website:

<http://nikonimglib.com/manual/>

The Built-in Flash

The built-in flash has a minimum range of 0.6 m (2 ft) and can not be used in the macro range of macro zoom lenses. It can be used with CPU lenses with focal lengths of 16–300 mm, although in some cases the flash may be unable to entirely light the subject at some ranges or focal lengths due to shadows cast by the lens. The following illustrations show the effect of vignetting caused by shadows cast by the lens when the flash is used.



Shadow



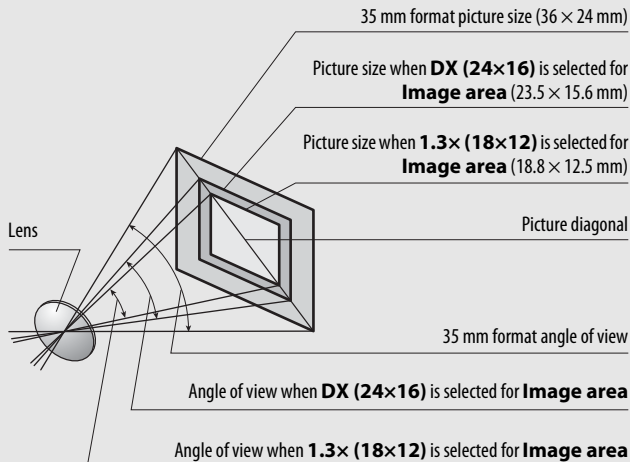
Vignetting

Remove lens hoods to prevent shadows. More information on lenses that can be used with the built-in flash may be found in the camera *Menu Guide*, which is available for download from the following website:

<http://nikonimglib.com/manual/>

Calculating Angle of View

The size of the area exposed by a 35mm camera is 36×24 mm. The size of the area exposed by the D7200 when **DX (24×16)** is selected for **Image area** in the photo shooting menu, in contrast, is 23.5×15.6 mm, meaning that the angle of view of a 35mm camera is approximately 1.5 times that of the D7200 (when **1.3× (18×12)** is selected, the size of the area exposed decreases, further reducing the angle of view by about 1.3×).



Optional Flash Units (Speedlights)

The camera supports the Nikon Creative Lighting System (CLS) and can be used with CLS-compatible flash units. The built-in flash will not fire when an optional flash unit is attached.

The Nikon Creative Lighting System (CLS)

Nikon's advanced Creative Lighting System (CLS) offers improved communication between the camera and compatible flash units for improved flash photography.

■ ■ CLS-Compatible Flash Units

The camera can be used with the following CLS-compatible flash units:

- **The SB-910, SB-900, SB-800, SB-700, SB-600, SB-500, SB-400, SB-300, and SB-R200:**

Flash unit	SB-910, SB-900 ¹	SB-800	SB-700 ¹	SB-600	SB-500 ²	SB-400 ³	SB-300 ³	SB-R200 ⁴
Feature								
Guide No. (ISO 100) ⁵	34/111	38/125	28/92	30/98	24/78	21/69	18/59	10/33

- 1 If a color filter is attached to the SB-910, SB-900, or SB-700 when **AUTO** or **⚡** (flash) is selected for white balance, the camera will automatically detect the filter and adjust white balance appropriately.
- 2 Users of the LED light can set camera white balance to **AUTO** or **⚡** for optimal results.
- 3 Wireless flash control is not available.
- 4 Controlled remotely with built-in flash in commander mode or using optional SB-910, SB-900, SB-800, SB-700, or SB-500 flash unit or SU-800 wireless Speedlight commander.
- 5 m/ft, 20 °C (68 °F), SB-910, SB-900, SB-800, SB-700, and SB-600 at 35 mm zoom head position; SB-910, SB-900, and SB-700 with standard illumination.

- **SU-800 Wireless Speedlight Commander:** When mounted on a CLS-compatible camera, the SU-800 can be used as a commander for remote SB-910, SB-900, SB-800, SB-700, SB-600, SB-500, or SB-R200 flash units in up to three groups. The SU-800 itself is not equipped with a flash.

Guide Number

To calculate the range of the flash at full power, divide the Guide Number by the aperture. If, for example, the flash unit has a Guide Number of 34 m or 111 ft (ISO 100, 20 °C/68 °F); its range at an aperture of f/5.6 is $34 \div 5.6$ or about 6.1 meters (or in feet, $111 \div 5.6 =$ approximately 19 ft 10 in.). For each twofold increase in ISO sensitivity, multiply the Guide Number by the square root of two (approximately 1.4).

The AS-15 Sync Terminal Adapter

When the AS-15 sync terminal adapter (available separately) is mounted on the camera accessory shoe, flash accessories can be connected via a sync terminal.

The following features are available with CLS-compatible flash units:

		SB-910, SB-900, SB-800	SB-700	SB-600	SB-500	SU-800	SB-R200	SB-400	SB-300		
Single flash	i-TTL	i-TTL balanced fill-flash for digital SLR ¹	✓	✓	✓	✓	—	—	✓	✓	
		Standard i-TTL fill-flash for digital SLR	✓ ²	✓	✓ ²	✓	—	—	✓	✓	
	AA	Auto aperture	✓ ³	—	—	—	—	—	—	—	
	A	Non-TTL auto	✓ ³	—	—	—	—	—	—	—	
	GN	Distance-priority manual	✓	✓	—	—	—	—	—	—	
	M	Manual	✓	✓	✓	✓ ⁴	—	—	✓ ⁴	✓ ⁴	
RPT	Repeating flash	✓	—	—	—	—	—	—	—		
Advanced Wireless Lighting	Master	Remote flash control	✓	✓	—	✓ ⁴	✓	—	—	—	
		i-TTL i-TTL	✓	✓	—	✓ ⁴	—	—	—	—	
		[A:B]	Quick wireless flash control	—	✓	—	—	✓ ⁵	—	—	—
		AA	Auto aperture	✓ ⁶	—	—	—	—	—	—	—
		A	Non-TTL auto	✓	—	—	—	—	—	—	—
		M	Manual	✓	✓	—	✓ ⁴	—	—	—	—
	RPT	Repeating flash	✓	—	—	—	—	—	—	—	
	Remote	i-TTL	i-TTL	✓	✓	✓	✓	—	✓	—	—
		[A:B]	Quick wireless flash control	✓	✓	✓	✓	—	✓	—	—
		AA	Auto aperture	✓ ⁶	—	—	—	—	—	—	—
		A	Non-TTL auto	✓	—	—	—	—	—	—	—
		M	Manual	✓	✓	✓	✓	—	✓	—	—
RPT		Repeating flash	✓	✓	✓	✓	—	—	—	—	
Color Information Communication (flash)		✓	✓	✓	✓	—	—	✓	✓		
Color Information Communication (LED light)		—	—	—	✓	—	—	—	—		

	SB-910, SB-900, SB-800	SB-700	SB-600	SB-500	SU-800	SB-R200	SB-400	SB-300
Auto FP High-Speed Sync ⁷	✓	✓	✓	✓	✓	✓	—	—
FV lock ⁸	✓	✓	✓	✓	✓	✓	✓	✓
AF-assist for multi-area AF	✓	✓	✓	—	✓ ⁹	—	—	—
Red-eye reduction	✓	✓	✓	✓	—	—	✓	—
Camera modeling illumination	✓	✓	✓	✓	✓	✓	—	—
Camera flash mode selection	—	—	—	✓	—	—	✓	✓
Camera flash unit firmware update	✓ ¹⁰	✓	—	✓	—	—	—	✓


- 1 Not available with spot metering.
- 2 Can also be selected with flash unit.
- 3 AA/A mode selection performed on flash unit using custom settings. Unless lens data have been provided using the **Non-CPU lens data** option in the setup menu, "A" will be selected when a non-CPU lens is used.
- 4 Can only be selected with camera.
- 5 Available only during close-up photography.
- 6 Unless lens data have been provided using the **Non-CPU lens data** option in the setup menu, non-TTL auto (A) is used with non-CPU lenses, regardless of mode selected with flash unit.
- 7 Available only in i-TTL, AA, A, GN, and M flash-control modes.
- 8 Available only in i-TTL, AA, and A flash-control modes.
- 9 Available only in commander mode.
- 10 Firmware updates for the SB-910 and SB-900 can be performed from the camera.

Using FV Lock with Optional Flash Units

FV lock (☐ 153) is available with optional flash units in TTL and (where supported) monitor pre-flash AA and monitor pre-flash A flash control modes. Note that when Advanced Wireless Lighting is used to control remote flash units, you will need to set the flash control mode for the master or at least one remote group to TTL or AA.

■ Other Flash Units

The following flash units can be used in non-TTL auto and manual modes.

Flash unit		SB-80DX, SB-28DX, SB-28, SB-26, SB-25, SB-24	SB-50DX ¹	SB-30, SB-27 ² , SB-22S, SB-22, SB-20, SB-16B, SB-15	SB-23, SB-29 ³ , SB-21B ³ , SB-29S ³
		Flash mode			
A	Non-TTL auto	✓	—	✓	—
M	Manual	✓	✓	✓	✓
	Repeating flash	✓	—	—	—
REAR	Rear-curtain sync⁴	✓	✓	✓	✓

- 1 Select mode **P**, **S**, **A**, or **M**, lower built-in flash, and use optional flash unit only.
- 2 Flash mode is automatically set to TTL and shutter-release is disabled. Set flash unit to **A** (non-TTL auto flash).
- 3 Autofocus is available with AF-S VR Micro-Nikkor 105mm f/2.8G IF-ED and AF-S Micro NIKKOR 60mm f/2.8G ED lenses only.
- 4 Available when camera is used to select flash mode.




Metering


The metering areas for FV lock when using optional flash unit are as follows:

Flash unit	Flash mode	Metered area
Stand-alone flash unit	i-TTL	4-mm circle in center of frame
	AA	Area metered by flash exposure meter
Used with other flash units (Advanced Wireless Lighting)	i-TTL	Entire frame
	AA	Area metered by flash exposure meter
	A (master flash)	

✔ Notes on Optional Flash Units

Refer to the flash unit manual for detailed instructions. If the flash unit supports CLS, refer to the section on CLS-compatible digital SLR cameras. The D7200 is not included in the “digital SLR” category in the SB-80DX, SB-28DX, and SB-50DX manuals.

If an optional flash unit is attached in shooting modes other than , , and , the flash will fire with every shot, even in modes in which the built-in flash can not be used.

i-TTL flash control can be used at ISO sensitivities between 100 and 12800. At values over 12800, the desired results may not be achieved at some ranges or aperture settings. If the flash-ready indicator () flashes for about three seconds after a photograph is taken in i-TTL or non-TTL auto mode, the flash has fired at full power and the photograph may be underexposed (CLS-compatible flash units only; for information on the exposure and flash charge indicators on other units, see the manual provided with the flash).

When an SC-series 17, 28, or 29 sync cable is used for off-camera flash photography, correct exposure may not be achieved in i-TTL mode. We recommend that you select standard i-TTL fill-flash control. Take a test shot and view the results in the monitor.

In i-TTL, use the flash panel or bounce adapter provided with the flash unit. Do not use other panels such as diffusion panels, as this may produce incorrect exposure.

The SB-910, SB-900, SB-800, SB-700, SB-600, SB-500, and SB-400 provide red-eye reduction, while the SB-910, SB-900, SB-800, SB-700, SB-600, and SU-800 provide AF-assist illumination with the following restrictions:

- **SB-910 and SB-900:** AF-assist illumination is available when 17–135 mm AF lenses are used with the focus points shown at right.



- **SB-800, SB-600, and SU-800:** AF-assist illumination is available when 24–105 mm AF lenses are used with the focus points shown at right.

24–34 mm	
35–49 mm	
50–105 mm	

- **SB-700:** AF-assist illumination is available when 24–135 mm AF lenses are used with the focus points shown at right.



Depending on the lens used and scene recorded, the in-focus indicator (●) may be displayed when the subject is not in focus, or the camera may be unable to focus and the shutter release will be disabled.














In mode **P**, the maximum aperture (minimum f-number) is limited according to ISO sensitivity, as shown below:

Maximum aperture at ISO equivalent of:							
100	200	400	800	1600	3200	6400	12800
4	5	5.6	7.1	8	10	11	13

If the maximum aperture of the lens is smaller than given above, the maximum value for aperture will be the maximum aperture of the lens.

Flash Control Mode

The information display shows the flash control mode for optional flash units attached to the camera accessory shoe as follows:

	Flash sync	Auto FP (282)
i-TTL		
Auto aperture (AA)		
Non-TTL auto flash (A)		
Distance-priority manual (GN)		
Manual		
Repeating flash		—
Advanced wireless lighting		

Use Only Nikon Flash Accessories

Use only Nikon flash units. Negative voltages or voltages over 250 V applied to the accessory shoe could not only prevent normal operation, but damage the sync circuitry of the camera or flash. Before using a Nikon flash unit not listed in this section, contact a Nikon-authorized service representative for more information.

Other Accessories

At the time of writing, the following accessories were available for the D7200.

Power sources	<ul style="list-style-type: none">• Rechargeable Li-ion Battery EN-EL15 (□ 21, 22; EN-EL15b and EN-EL15a batteries can also be used)• Battery Charger MH-25a (□ 21)• Multi-Power Battery Pack MB-D15• Power Connector EP-5B, AC Adapter EH-5b
Viewfinder eyepiece accessories	<ul style="list-style-type: none">• DK-20C Eyepiece Correction Lenses• Magnifying Eyepiece DK-21M• Magnifier DG-2• Eyepiece Adapter DK-22• Right-Angle Viewing Attachment DR-6
Remote controls/ wireless remote controllers/ remote cords	<ul style="list-style-type: none">• Wireless Remote Control ML-L3 (□ 156)• Wireless Remote Controllers WR-T10 and WR-R10 (□ 160)• Wireless Remote Controller WR-1 (□ 160)• Remote Cord MC-DC2 (□ 58)
GPS units	<ul style="list-style-type: none">• GPS Unit GP-1/GPS Unit GP-1A (□ 227)
LAN adapters	<ul style="list-style-type: none">• Communication Unit UT-1• Wireless Transmitter WT-5
HDMI cables	HDMI Cable HC-E1
Microphones	Stereo Microphone ME-1 (□ 193)
Accessory shoe covers	Accessory Shoe Cover BS-1
Body cap	Body Cap BF-1B/Body Cap BF-1A
Software	<ul style="list-style-type: none">• Camera Control Pro 2• ViewNX-i• Capture NX-D

Availability may vary with country or region. See our website or brochures for the latest information.

Caring for the Camera

Storage

When the camera will not be used for an extended period, remove the battery and store it in a cool, dry area with the terminal cover in place. To prevent mold or mildew, store the camera in a dry, well-ventilated area. Do not store your camera with naphtha or camphor moth balls or in locations that:

- are poorly ventilated or subject to humidities of over 60%
- are next to equipment that produces strong electromagnetic fields, such as televisions or radios
- are exposed to temperatures above 50 °C (122 °F) or below -10 °C (14 °F)

Cleaning

Camera body	Use a blower to remove dust and lint, then wipe gently with a soft, dry cloth. After using the camera at the beach or seaside, wipe off sand or salt with a cloth lightly dampened in distilled water and dry thoroughly. Important: <i>Dust or other foreign matter inside the camera may cause damage not covered under warranty.</i>
Lens, mirror, and viewfinder	These glass elements are easily damaged. Remove dust and lint with a blower. If using an aerosol blower, keep the can vertical to prevent the discharge of liquid. To remove fingerprints and other stains, apply a small amount of lens cleaner to a soft cloth and clean with care.
Monitor	Remove dust and lint with a blower. When removing fingerprints and other stains, wipe the surface lightly with a soft cloth or chamois leather. Do not apply pressure, as this could result in damage or malfunction.

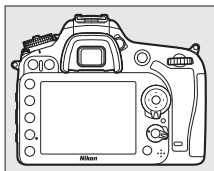
Do not use alcohol, thinner, or other volatile chemicals.

Image Sensor Cleaning

If you suspect that dirt or dust on the image sensor is appearing in photographs, you can clean the sensor using the **Clean image sensor** option in the setup menu. The sensor can be cleaned at any time using the **Clean now** option, or cleaning can be performed automatically when the camera is turned on or off.




■ ■ “Clean Now”

Holding the camera base down, select **Clean image sensor** in the setup menu, then highlight **Clean now** and press **OK**. The camera will check the image sensor and then begin cleaning. **b 5 Y** flashes in the control panel and other operations can not be performed while cleaning is in progress. Do not remove or disconnect the power source until cleaning ends and the setup menu is displayed.




■ “Clean at Startup/Shutdown”

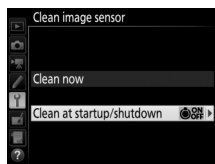
Choose from the following options:

Option	Description
 Clean at startup	The image sensor is automatically cleaned each time the camera is turned on.
 Clean at shutdown	The image sensor is automatically cleaned during shutdown each time the camera is turned off.
 Clean at startup & shutdown	The image sensor is cleaned automatically at startup and at shutdown.
Cleaning off	Automatic image sensor cleaning off.


1 Select **Clean at startup/shutdown**.

Display the **Clean image sensor** menu as described on page 321.

Highlight **Clean at startup/shutdown** and press .



2 Select an option.

Highlight an option and press .

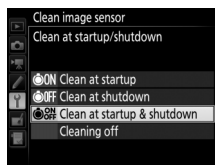


Image Sensor Cleaning

Using camera controls during startup interrupts image sensor cleaning. Image sensor cleaning may not be performed at startup if the flash is charging.


If dust can not be fully removed using the options in the **Clean image sensor** menu, clean the image sensor manually (📖 324) or consult a Nikon-authorized service representative.

If image sensor cleaning is performed several times in succession, image sensor cleaning may be temporarily disabled to protect the camera's internal circuitry. Cleaning can be performed again after a short wait.

Manual Cleaning

If foreign matter can not be removed from the image sensor using the **Clean image sensor** option in the setup menu (☰ 321), the sensor can be cleaned manually as described below. Note, however, that the sensor is extremely delicate and easily damaged. Nikon recommends that the sensor be cleaned only by Nikon-authorized service personnel.


1 Charge the battery or connect an AC adapter.

A reliable power source is required when inspecting or cleaning the image sensor. Turn the camera off and insert a fully-charged battery or connect an optional AC adapter and power connector. The **Lock mirror up for cleaning** option is only available in the setup menu at battery levels over .

2 Remove the lens.

Turn the camera off and remove the lens.

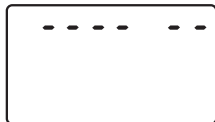
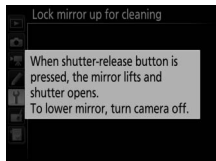
3 Select **Lock mirror up for cleaning**.

Turn the camera on and highlight **Lock mirror up for cleaning** in the setup menu and press .



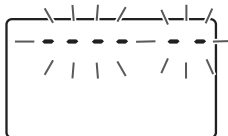
4 Press **OK**.

The message shown at right will be displayed in the monitor and a row of dashes will appear in the control panel and viewfinder. To restore normal operation without inspecting the image sensor, turn the camera off.



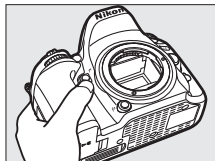
5 Raise the mirror.

Press the shutter-release button all the way down. The mirror will be raised and the shutter curtain will open, revealing the image sensor. The display in the viewfinder will turn off and the row of dashes in the control panel will flash.



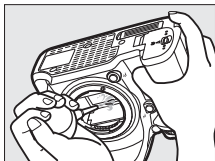
6 Examine the image sensor.

Holding the camera so that light falls on the image sensor, examine the sensor for dust or lint. If no foreign objects are present, proceed to Step 8.



7 Clean the sensor.

Remove any dust and lint from the sensor with a blower. Do not use a blower-brush, as the bristles could damage the sensor. Dirt that can not be removed with a blower can only be removed by Nikon-authorized service personnel. Under no circumstances should you touch or wipe the sensor.



8 Turn the camera off.

The mirror will return to the down position and the shutter curtain will close. Replace the lens or body cap.

Use a Reliable Power Source

The shutter curtain is delicate and easily damaged. If the camera powers off while the mirror is raised, the curtain will close automatically. To prevent damage to the curtain, observe the following precautions:

- Do not turn the camera off or remove or disconnect the power source while the mirror is raised.
- If the battery runs low while the mirror is raised, a beep will sound and the self-timer lamp will flash to warn that the shutter curtain will close and the mirror will be lowered after about two minutes. End cleaning or inspection immediately.

✔ Foreign Matter on the Image Sensor

Foreign matter entering the camera when lenses or body caps are removed or exchanged (or in rare circumstances lubricant or fine particles from the camera itself) may adhere to the image sensor, where it may appear in photographs taken under certain conditions. To protect the camera when no lens is in place, be sure to replace the body cap provided with the camera, being careful to first remove all dust and other foreign matter that may be adhering to the camera mount, lens mount, and body cap. Avoid attaching the body cap or exchanging lenses in dusty environments.

Should foreign matter find its way onto the image sensor, use the image sensor cleaning option as described on page 321. If the problem persists, clean the sensor manually (☐ 324) or have the sensor cleaned by authorized Nikon service personnel. Photographs affected by the presence of foreign matter on the sensor can be retouched using the clean image options available in some imaging applications.

✔ Servicing the Camera and Accessories

The camera is a precision device and requires regular servicing. Nikon recommends that the camera be inspected by the original retailer or Nikon-authorized service representative once every one to two years, and that it be serviced once every three to five years (note that fees apply to these services). Frequent inspection and servicing are particularly recommended if the camera is used professionally. Any accessories regularly used with the camera, such as lenses or optional flash units, should be included when the camera is inspected or serviced.

Caring for the Camera and Battery: Cautions

Do not drop: The product may malfunction if subjected to strong shocks or vibration.

Keep dry: This product is not waterproof, and may malfunction if immersed in water or exposed to high levels of humidity. Rusting of the internal mechanism can cause irreparable damage.

Avoid sudden changes in temperature: Sudden changes in temperature, such as those that occur when entering or leaving a heated building on a cold day, can cause condensation inside the device. To prevent condensation, place the device in a carrying case or plastic bag before exposing it to sudden changes in temperature.

Keep away from strong magnetic fields: Do not use or store this device in the vicinity of equipment that generates strong electromagnetic radiation or magnetic fields. Strong static charges or the magnetic fields produced by equipment such as radio transmitters could interfere with the monitor, damage data stored on the memory card, or affect the product's internal circuitry.

Do not leave the lens pointed at the sun: Do not leave the lens pointed at the sun or other strong light source for an extended period. Intense light may cause the image sensor to deteriorate or produce a white blur effect in photographs.

Turn the product off before removing or disconnecting the power source: Do not unplug the product or remove the battery while the product is on or while images are being recorded or deleted. Forcibly cutting power in these circumstances could result in loss of data or in damage to product memory or internal circuitry. To prevent an accidental interruption of power, avoid carrying the product from one location to another while the AC adapter is connected.

Cleaning: When cleaning the camera body, use a blower to gently remove dust and lint, then wipe gently with a soft, dry cloth. After using the camera at the beach or seaside, wipe off any sand or salt using a cloth lightly dampened in pure water and then dry the camera thoroughly. In rare instances, static electricity may cause LCDs to light up or go dark. This does not indicate a malfunction, and the display will soon return to normal.

The lens and mirror are easily damaged. Dust and lint should be gently removed with a blower. When using an aerosol blower, keep the can vertical to prevent discharge of liquid. To remove fingerprints and other stains from the lens, apply a small amount of lens cleaner to a soft cloth and wipe the lens carefully.

See “Image Sensor Cleaning” (□ 321, 324) for information on cleaning the image sensor.

Lens contacts: Keep the lens contacts clean.

Do not touch the shutter curtain: The shutter curtain is extremely thin and easily damaged. Under no circumstances should you exert pressure on the curtain, poke it with cleaning tools, or subject it to powerful air currents from a blower. These actions could scratch, deform, or tear the curtain.

Storage: To prevent mold or mildew, store the camera in a dry, well-ventilated area. If you are using an AC adapter, unplug the adapter to prevent fire. If the product will not be used for an extended period, remove the battery to prevent leakage and store the camera in a plastic bag containing a desiccant. Do not, however, store the camera case in a plastic bag, as this may cause the material to deteriorate. Note that desiccant gradually loses its capacity to absorb moisture and should be replaced at regular intervals.

To prevent mold or mildew, take the camera out of storage at least once a month. Turn the camera on and release the shutter a few times before putting it away.

Store the battery in a cool, dry place. Replace the terminal cover before putting the battery away.

Notes on the monitor: The monitor is constructed with extremely high precision; at least 99.99% of pixels are effective, with no more than 0.01% being missing or defective. Hence while these displays may contain pixels that are always lit (white, red, blue, or green) or always off (black), this is not a malfunction and has no effect on images recorded with the device.

Images in the monitor may be difficult to see in a bright light.

Do not apply pressure to the monitor, as this could cause damage or malfunction. Dust or lint on the monitor can be removed with a blower. Stains can be removed by wiping lightly with a soft cloth or chamois leather. Should the monitor break, care should be taken to avoid injury from broken glass and to prevent liquid crystal from the monitor touching the skin or entering the eyes and mouth.

The battery and charger: Batteries may leak or explode if improperly handled. *Read and follow the warnings and cautions on pages x–xiii of this manual.* Observe the following precautions when handling batteries:

- Use only batteries approved for use in this equipment.
- Do not expose the battery to flame or excessive heat.
- Keep the battery terminals clean.
- Turn the product off before replacing the battery.
- Remove the battery from the camera or charger when not in use and replace the terminal cover. These devices draw minute amounts of charge even when off and could draw the battery down to the point that it will no longer function. If the battery will not be used for some time, insert it in the camera and run it flat before removing it from the camera for storage. The battery should be stored in a cool location with an ambient temperature of 15 °C to 25 °C (59 °F to 77 °F; avoid hot or extremely cold locations). Repeat this process at least once every six months.
- Turning the camera on or off repeatedly when the battery is fully discharged will shorten battery life. Batteries that have been fully discharged must be charged before use.

- The internal temperature of the battery may rise while the battery is in use. Attempting to charge the battery while the internal temperature is elevated will impair battery performance, and the battery may not charge or charge only partially. Wait for the battery to cool before charging.
- Charge the battery indoors at ambient temperatures of 5 °C–35 °C (41 °F–95 °F). Do not use the battery at ambient temperatures below 0 °C (32 °F) or above 40 °C (104 °F); failure to observe this precaution could damage the battery or impair its performance. Capacity may be reduced and charging times increase at battery temperatures from 0 °C (32 °F) to 15 °C (59 °F) and from 45 °C (113 °F) to 60 °C (140 °F). The battery will not charge if its temperature is below 0 °C (32 °F) or above 60 °C (140 °F).
- If the **CHARGE** lamp flashes quickly (about eight times a second) during charging, confirm that the temperature is in the correct range and then unplug the charger and remove and reinsert the battery. If the problem persists, cease use immediately and take battery and charger to your retailer or a Nikon-authorized service representative.
- Do not move the charger or touch the battery during charging. Failure to observe this precaution could in very rare instances result in the charger showing that charging is complete when the battery is only partially charged. Remove and reinsert the battery to begin charging again.
- Battery capacity may temporarily drop if the battery is charged at low temperatures or used at a temperature below the temperature at which it was charged. If the battery is charged at a temperature below 5 °C (41 °F), the battery life indicator in the **Battery info** (☐ 291) display may show a temporary decrease.
- Continuing to charge the battery after it is fully charged can impair battery performance.

- A marked drop in the time a fully charged battery retains its charge when used at room temperature indicates that it requires replacement. Purchase a new battery.
- The supplied power cable and AC wall adapter are for use with the MH-25a only. Use the charger with compatible batteries only. Unplug when not in use.
- Charge the battery before use. When taking photographs on important occasions, ready a spare battery and keep it fully charged. Depending on your location, it may be difficult to purchase replacement batteries on short notice. Note that on cold days, the capacity of batteries tends to decrease. Be sure the battery is fully charged before taking photographs outside in cold weather. Keep a spare battery in a warm place and exchange the two as necessary. Once warmed, a cold battery may recover some of its charge.
- Used batteries are a valuable resource; recycle in accord with local regulations.

Troubleshooting

If the camera fails to function as expected, check the list of common problems below before consulting your retailer or Nikon-authorized service representative.

Battery/Display

The camera is on but does not respond: Wait for recording to end. If the problem persists, turn the camera off. If the camera does not turn off, remove and reinsert the battery or, if you are using an AC adapter, disconnect and reconnect the AC adapter. Note that although any data currently being recorded will be lost, data that have already been recorded will not be affected by removing or disconnecting the power source.

Viewfinder is out of focus: Adjust viewfinder focus (☐ 25). If this does not correct the problem, select single-servo autofocus (**AF-S**; ☐ 83), single-point AF (☐ 86), and the center focus point (☐ 91), and then frame a high-contrast subject in the center focus point and press the shutter-release button halfway to focus the camera. With the camera in focus, use the diopter adjustment control to bring the subject into clear focus in the viewfinder. If necessary, viewfinder focus can be further adjusted using optional corrective lenses (☐ 319).

Viewfinder is dark: Insert a fully-charged battery (☐ 21, 26).

Displays turn off without warning: Choose longer delays for Custom Setting c2 (**Standby timer**) or c4 (**Monitor off delay**; ☐ 279).

Control panel and viewfinder displays are unresponsive and dim: The response times and brightness of these displays vary with temperature.

Fine lines are visible around active focus point or display turns red when focus point is highlighted: These phenomena are normal for this type of viewfinder and do not indicate a malfunction.

Shooting (All Modes)

Camera takes time to turn on: Delete files or folders.

Shutter-release disabled:

- Memory card is locked, full, or not inserted (☐ 22, 29).
 - **Release locked** is selected for Custom Setting f7 (**Slot empty release lock**; ☐ 286) and no memory card is inserted (☐ 29).
 - Built-in flash is charging (☐ 36).
 - Camera is not in focus (☐ 34).
 - Aperture ring for CPU lens not locked at highest f-number (does not apply to type G and E lenses). If **F E** is displayed in control panel, select **Aperture ring** for Custom Setting f5 (**Customize command dials**) > **Aperture setting** to use lens aperture ring to adjust aperture (☐ 285).
 - Non-CPU lens is attached but camera is not in mode **A** or **M** (☐ 51).
-

Camera is slow to respond to shutter-release button: Select **Off** for Custom Setting d4 (**Exposure delay mode**; ☐ 280).

No photo taken when remote control shutter-release button is pressed:

- Replace battery in remote control.
 - Choose an option other than **Off** for **Remote control mode (ML-L3)** (☐ 156).
 - Flash is charging (☐ 158).
 - Time selected for Custom Setting c5 (**Remote on duration (ML-L3)**, ☐ 279) has elapsed.
 - Bright light is interfering with remote.
-

Photos are out of focus:

- Rotate focus-mode selector to **AF** (☐ 83).
 - Camera unable to focus using autofocus: use manual focus or focus lock (☐ 93, 97).
-

Focus does not lock when shutter-release button is pressed halfway: Use ^{AE-L}_{AF-L} **AE-L/AF-L** button to lock focus when **AF-C** is selected for focus mode or when photographing moving subjects in **AF-A** mode.

Can not select focus point:

- Unlock focus selector lock (☐ 89).
- Auto-area AF selected, or face detected when face-priority AF is selected in live view: choose another mode (☐ 86, 88).
- Camera is in playback mode (☐ 229) or menus are in use (☐ 266).
- Press shutter-release button halfway to start standby timer (☐ 37).

Can not select AF mode: Manual focus selected (☐ 83, 97).

Can not select AF-area mode: Manual focus selected (☐ 83, 97).

Only one shot taken each time shutter-release button is pressed in continuous release mode: Continuous shooting is not available if built-in flash fires (☐ 148).

Image size can not be changed: Image quality set to **NEF (RAW)** (☐ 77).


Camera is slow to record photos: Turn long exposure noise reduction off (☐ 271).

AF-assist illuminator does not light:

- AF-assist illuminator does not light if **AF-C** is selected for autofocus mode (☐ 83) or if continuous-servo autofocus is selected when the camera is in **AF-A** mode. Choose **AF-S**. If an option other than auto-area AF is selected for AF-area mode, select center focus point (☐ 91).
- The camera is currently in live view.
- **Off** is selected for Custom Setting a9 (**Built-in AF-assist illuminator**, ☐ 277).
- Illuminator has turned off automatically. Illuminator may become hot with continued use; wait for it to cool down.

Smudges appear in photographs: Clean front and rear lens elements. If problem persists, perform image sensor cleaning (☐ 321).

Noise (bright spots, randomly-spaced bright pixels, fog, or lines) appear in photos:

- Bright spots, randomly-spaced bright pixels, fog, and lines can be reduced by lowering ISO sensitivity.
- Use the **Long exposure NR** option in the photo shooting menu to limit the occurrence of bright spots or fog in photos taken at shutter speeds slower than 1 s (☐ 271).
- Fog and bright spots may indicate that the camera's internal temperature has become elevated due to high ambient temperatures, long exposures, or similar causes: turn the camera off and wait for it to cool before resuming shooting.
- At high ISO sensitivities, lines may appear in photos taken with some optional flash units; if this occurs, choose a lower value.
- At high ISO sensitivities, including **Hi BW1** or **Hi BW2** and high values selected with auto ISO sensitivity control, randomly-spaced bright pixels can be reduced by selecting **High**, **Normal**, or **Low** for **High ISO NR** in the photo or movie shooting menu (☐ 271, 275).
- At high ISO sensitivities, bright spots, randomly-spaced bright pixels, fog, or lines may be more noticeable in long exposures, multiple exposures, and photos taken at high ambient temperatures or with Active D-Lighting enabled, **Flat** selected for **Set Picture Control** (☐ 130) or extreme values selected for Picture Control parameters (☐ 133).
- In  mode, randomly-spaced bright pixels, fog, or lines may be more noticeable in pictures shot under low light.

Flicker or banding appears in live view: Choose an option for **Flicker reduction** that matches the frequency of the local AC power supply (☐ 290).

Bright regions or bands appear in live view: A flashing sign, flash, or other light source with brief duration was used during live view.

Sound is not recorded with movies: **Microphone off** is selected for **Microphone sensitivity** in the movie shooting menu (☐ 273).

Live view ends unexpectedly or does not start: Live view may end automatically to prevent damage to the camera's internal circuits if:

- The ambient temperature is high
- The camera has been used for extended periods in live view or to record movies
- The camera has been used in continuous release modes for extended periods






If live view does not start when you press the  button, wait for the internal circuits to cool and then try again. Note that the camera may feel warm to the touch, but this does not indicate a malfunction.


Image artifacts appear during live view: "Noise" (randomly-spaced bright pixels, fog, or lines) and unexpected colors may appear if you zoom in on the view through the lens ( 38) during live view; in movies, the amount and distribution of randomly-spaced bright pixels, fog, and bright spots is affected by frame size and rate ( 166). Randomly-spaced bright pixels, fog, or bright spots may also arise as a result of increases in the temperature of the camera's internal circuits during live view; exit live view when the camera is not in use.

Menu item can not be selected: Some options are not available in all modes.

Shooting (P, S, A, M)

Shutter-release disabled:

- Non-CPU lens is attached: rotate camera mode dial to **A** or **M** ( 51).
 - Mode dial rotated to **S** after shutter speed of **h**, **w**, **l**, **b** or **-** selected in mode **M**: choose new shutter speed ( 53).
-

Full range of shutter speeds not available: Flash in use. Flash sync speed can be selected using Custom Setting e1 (**Flash sync speed**); when using compatible flash units, choose **1/320 s (Auto FP)** or **1/250 s (Auto FP)** for full range of shutter speeds ( 282).

Colors are unnatural:

- Adjust white balance to match light source (☞ 111).
- Adjust **Set Picture Control** settings (☞ 130).

Can not measure white balance: Subject is too dark or too bright (☞ 123).

Image can not be selected as source for manual preset white balance: Image was not created with D7200 (☞ 127).

White balance bracketing unavailable:

- NEF (RAW) or NEF+JPEG image quality option selected for image quality (☞ 77).
- Multiple exposure mode is in effect (☞ 211).

Effects of Picture Control differ from image to image: **A** (auto) is selected for sharpening, clarity, contrast, or saturation. For consistent results over a series of photos, choose another setting (☞ 133).

Metering can not be changed: Autoexposure lock is in effect (☞ 107).

Exposure compensation can not be used: Camera is in mode **M**. Choose another mode.

Noise (reddish areas or other artifacts) appears in long time-exposures: Enable long exposure noise reduction (☞ 271).

Playback

NEF (RAW) image is not played back: Photo was taken at image quality of NEF + JPEG (☞ 77).

Can not view pictures recorded with other cameras: Pictures recorded with other makes of camera may not be displayed correctly.

Some images are not displayed during playback: Select **All** for **Playback folder** (☞ 266).

The camera displays a message stating that the folder contains no images: Use the **Playback folder** option in the playback menu to choose a folder that contains images (☐ 266).

“Tall” (portrait) orientation photos are displayed in “wide” (landscape) orientation:

- Select **On** for **Rotate tall** (☐ 267).
 - Photo was taken with **Off** selected for **Auto image rotation** (☐ 290).
 - Camera was pointed up or down when photo was taken.
 - Photo is displayed in image review (☐ 230).
-

Can not delete picture:

- Picture is protected: remove protection (☐ 245).
 - Memory card is locked (☐ 29).
-

Can not retouch picture: Photo can not be further edited with this camera (☐ 346).

Can not change print order:

- Memory card is full: delete pictures (☐ 40, 246).
 - Memory card is locked (☐ 29).
-

Can not select photo for printing: Photo is in NEF (RAW) format. Transfer photos to computer and print using Capture NX-D (☐ ii). NEF (RAW) photos can be saved in JPEG format using **NEF (RAW) processing** (☐ 302).

Photo is not displayed on high-definition video device: Confirm that HDMI cable is connected.

Camera does not respond to remote control for HDMI-CEC television:

- Select **On** for **HDMI > Device control** in the setup menu (☐ 292).
 - Adjust HDMI-CEC settings for the television as described in documentation provided with the device.
-

Can not transfer photos to computer: OS not compatible with camera or transfer software. Use card reader to copy photos to computer.

Image Dust Off option in Capture NX-D does not have desired effect: Image sensor cleaning changes the position of dust on the image sensor. Dust off reference data recorded before image sensor cleaning is performed can not be used with photographs taken after image sensor cleaning is performed. Dust off reference data recorded after image sensor cleaning is performed can not be used with photographs taken before image sensor cleaning is performed.

Computer displays NEF (RAW) images differently from camera: Third-party software does not display effects of Picture Controls, Active D-Lighting, or vignette control. Use Capture NX-D (□ ii).

Wi-Fi (Wireless Networks)

Smart devices do not display the camera SSID (network name):

- Confirm that **Enable** is selected for **Wi-Fi > Network connection** in the camera setup menu (□ 251).
 - Try turning the smart device Wi-Fi off and then on again.
-

Can not connect to smart devices using NFC (□ 254): Choose another connection method (□ 251).








Miscellaneous


Date of recording is not correct: The camera clock is less accurate than most watches and household clocks. Check the clock regularly against more accurate timepieces and reset as necessary.


Menu item can not be selected: Some options are not available at certain combinations of settings or when no memory card is inserted. Note that **Battery info** option is not available when camera is powered by an optional power connector and AC adapter.








Error Messages

This section lists the indicators and error messages that appear in the viewfinder, control panel, and monitor.


Indicator		Problem	Solution	
Control panel	Viewfinder			
 (flashes)		Lens aperture ring is not set to minimum aperture.	Set ring to minimum aperture (highest f-number).	29
		Low battery.	Ready a fully-charged spare battery.	21
 (flashes)	 (flashes)	<ul style="list-style-type: none"> Battery exhausted. Battery can not be used. An extremely exhausted rechargeable Li-ion battery or a third-party battery is inserted either in the camera or in the optional MB-D15 battery pack. 	<ul style="list-style-type: none"> Recharge or replace battery. Contact Nikon-authorized service representative. Replace the battery, or recharge the battery if the rechargeable Li-ion battery is exhausted. 	xviii, 21, 22, 319
		No lens attached, or non-CPU lens attached without specifying maximum aperture. Aperture shown in stops from maximum aperture.	Aperture value will be displayed if maximum aperture is specified.	224

Indicator		Problem	Solution	📖
Control panel	View-finder			
F - - (flashes)		• No lens attached.	• Attach non-IX Nikkor lens. If a CPU lens is attached, remove and reattach the lens.	23, 304
		• Non-CPU lens attached.	• Select mode A or M .	51
—	▶ ◀ (flashes)	Camera unable to focus using autofocus.	Change composition or focus manually.	96, 97
(Exposure indicators and shutter speed or aperture display flash)		Subject too bright; photo will be overexposed.	• Use a lower ISO sensitivity.	99
			• In shooting mode: P Use a third-party ND filter	—
			S Increase shutter speed	53
			A Choose a smaller aperture (higher f-number)	54
			 Choose another shooting mode	6
		Subject too dark; photo will be underexposed.	• Use a higher ISO sensitivity.	99
			• In shooting mode: P Use flash	146
			S Lower shutter speed	53
			A Choose a larger aperture (lower f-number)	54

Indicator		Problem	Solution	📖
Control panel	Viewfinder			
b u l b (flashes)		b u l b selected in mode S .	Change shutter speed or select mode M .	53, 56
- - (flashes)		- - selected in mode S .	Change shutter speed or select mode M .	53, 56
b u S Y (flashes)	b S Y (flashes)	Processing in progress.	Wait until processing is complete.	—
—	 (flashes)	If indicator flashes for 3s after flash fires, photo may be underexposed.	Check photo in monitor; if underexposed, adjust settings and try again.	229
F u l l (flashes)	F u l (flashes)	Memory insufficient to record further photos at current settings, or camera has run out of file or folder numbers.	<ul style="list-style-type: none"> • Reduce quality or size. • Delete photographs after copying important images to computer or other device. • Insert new memory card. 	77, 81 246 22
E r r (flashes)		Camera malfunction.	Release shutter. If error persists or appears frequently, consult Nikon-authorized service representative.	—

Indicator		Problem	Solution	
Monitor	Control panel			
No memory card.	 (- E -)	Camera cannot detect memory card.	Turn camera off and confirm that card is correctly inserted.	22
This memory card cannot be used. Card may be damaged. Insert another card.	 <i>E r r</i> ,  <i>E r r</i> (flashes)	<ul style="list-style-type: none"> • Error accessing memory card. • Unable to create new folder. 	<ul style="list-style-type: none"> • Use Nikon-approved card. • Check that contacts are clean. If card is damaged, contact retailer or Nikon-authorized service representative. • Delete files or insert new memory card after copying important images to computer or other device. 	379 — 22, 246
	 <i>E r r</i> ,  <i>E r r</i> (flashes)	Camera can not control Eye-Fi card.	<ul style="list-style-type: none"> • Check that Eye-Fi card firmware is up to date. • Copy files on Eye-Fi card to a computer or other device and format card, or insert new card. 	— 22, 293

Indicator		Problem	Solution	📖
Monitor	Control panel			
Memory card is locked. Slide lock to "write" position. Not available if Eye-Fi card is locked.	Ⓛ Ⓜ Ⓡ Ⓛ (flashes)	Memory card is locked (write protected).	Slide card write-protect switch to "write" position.	29
	Ⓛ Ⓜ Ⓡ Ⓛ, ⓔ Ⓡ Ⓡ (flashes)	Eye-Fi card is locked (write protected).		
This card is not formatted. Format the card.	[F Ⓡ Ⓡ] (flashes)	Memory card has not been formatted for use in camera.	Format memory card or insert new memory card.	22, 289
Clock has been reset.	—	Camera clock is not set.	Set camera clock.	24, 290
Unable to start live view. Please wait.	—	The internal temperature of the camera is high.	Wait for the internal circuits to cool before resuming live view.	337
Folder contains no images.	—	No images on memory card or in folder(s) selected for playback.	Select folder containing images from Playback folder menu or insert memory card containing images.	22, 266
All images are hidden.	—	All photos in current folder are hidden.	No images can be played back until another folder has been selected or Hide image used to allow at least one image to be displayed.	266

Indicator		Problem	Solution	
Monitor	Control panel			
Cannot display this file.	—	File has been created or modified using a computer or different make of camera, or file is corrupt.	File can not be played back on camera.	—
Cannot select this file.	—	Selected image can not be retouched.	Images created with other devices can not be retouched.	—
This movie cannot be edited.	—	The selected movie can not be edited.	<ul style="list-style-type: none"> • Movies created with other devices can not be edited. • Movies must be at least two seconds long. 	182
Could not connect; multiple devices detected. Try again later.	—	Multiple smart devices are attempting to connect to camera simultaneously.	Wait a few minutes before trying again.	—
Error	—	Wi-Fi error.	Select Disable for Wi-Fi > Network connection , then select Enable again.	256

Indicator		Problem	Solution	📖
Monitor	Control panel			
Network access not available until camera cools.	—	The internal temperature of the camera is high.	Turn camera off and try again after waiting for camera to cool.	—
Check printer.	—	Printer error.	Check printer. To resume, select Continue (if available).	—*
Check paper.	—	Paper in printer is not of selected size.	Insert paper of correct size and select Continue .	—*
Paper jam.	—	Paper is jammed in printer.	Clear jam and select Continue .	—*
Out of paper.	—	Printer is out of paper.	Insert paper of selected size and select Continue .	—*
Check ink supply.	—	Ink error.	Check ink. To resume, select Continue .	—*
Out of ink.	—	Printer is out of ink.	Replace ink and select Continue .	—*

* See printer manual for more information.

Specifications

■ Nikon D7200 Digital Camera


Type	
Type	Single-lens reflex digital camera
Lens mount	Nikon F mount (with AF coupling and AF contacts)
Effective angle of view	Nikon DX format; focal length in 35 mm [135] format equivalent to approx. 1.5× that of lenses with FX format angle of view
Effective pixels	
Effective pixels	24.2 million
Image sensor	
Image sensor	23.5 × 15.6 mm CMOS sensor
Total pixels	24.72 million
Dust-reduction System	Image sensor cleaning, Image Dust Off reference data (Capture NX-D software required)
Storage	
Image size (pixels)	<ul style="list-style-type: none">• DX (24×16) image area 6000 × 4000 (L) 4496 × 3000 (M) 2992 × 2000 (S)• 1.3× (18×12) image area 4800 × 3200 (L) 3600 × 2400 (M) 2400 × 1600 (S)• Photographs with image area of DX (24×16) taken with live view selector rotated to 在 in live view 6000 × 3368 (L) 4496 × 2528 (M) 2992 × 1680 (S)• Photographs with image area of 1.3× (18×12) taken with live view selector rotated to 在 in live view 4800 × 2696 (L) 3600 × 2024 (M) 2400 × 1344 (S)


Storage	
File format	<ul style="list-style-type: none"> • NEF (RAW): 12 or 14 bit, lossless compressed or compressed • JPEG: JPEG-Baseline compliant with fine (approx. 1 : 4), normal (approx. 1 : 8), or basic (approx. 1 : 16) compression (Size priority); Optimal quality compression available • NEF (RAW) + JPEG: Single photograph recorded in both NEF (RAW) and JPEG formats
Picture Control System	Standard, Neutral, Vivid, Monochrome, Portrait, Landscape, Flat; selected Picture Control can be modified; storage for custom Picture Controls
Media	SD (Secure Digital) and UHS-I compliant SDHC and SDXC memory cards
Double slot	Slot 2 can be used for overflow or backup storage or for separate storage of copies created using NEF+JPEG; pictures can be copied between cards.
File system	DCF 2.0, DPOF, Exif 2.3, PictBridge
Viewfinder	
Viewfinder	Eye-level pentaprism single-lens reflex viewfinder
Frame coverage	<ul style="list-style-type: none"> • DX (24×16) image area: Approx. 100% horizontal and 100% vertical • 1.3× (18×12) image area: Approx. 97% horizontal and 97% vertical
Magnification	Approx. $0.94 \times$ (50 mm f/1.4 lens at infinity, -1.0 m^{-1})
Eyepoint	19.5 mm (-1.0 m^{-1} ; from center surface of viewfinder eyepiece lens)
Diopter adjustment	-2 – $+1 \text{ m}^{-1}$

Viewfinder	
Focusing screen	Type B BriteView Clear Matte Mark II screen with AF area brackets (framing grid can be displayed)
Reflex mirror	Quick return
Depth-of-field preview	Pressing Pv button stops lens aperture down to value selected by user (A and M modes) or by camera (other modes)
Lens aperture	Instant return, electronically controlled
Lens	
Compatible lenses	<p>Compatible with AF NIKKOR lenses, including type G, E, and D lenses (some restrictions apply to PC lenses) and DX lenses, AI-P NIKKOR lenses, and non-CPU AI lenses (A and M modes only). IX NIKKOR lenses, lenses for the F3AF, and non-AI lenses can not be used.</p> <p>The electronic rangefinder can be used with lenses that have a maximum aperture of f/5.6 or faster (the electronic rangefinder supports the center 1 focus point with lenses that have a maximum aperture of f/8 or faster).</p>

Shutter	
Type	Electronically-controlled vertical-travel focal-plane shutter
Speed	$\frac{1}{8000}$ –30 s in steps of $\frac{1}{3}$ or $\frac{1}{2}$ EV, bulb, time, X250
Flash sync speed	X= $\frac{1}{250}$ s; synchronizes with shutter at $\frac{1}{320}$ s or slower (flash range drops at speeds between $\frac{1}{250}$ and $\frac{1}{320}$ s)
Release	
Release mode	S (single frame), CL (continuous low speed), CH (continuous high speed), Q (quiet shutter-release), \odot (self-timer), MUP (mirror up)
Approximate frame advance rate	<ul style="list-style-type: none"> • JPEG and 12-bit NEF (RAW) images recorded with DX (24×16) selected for Image area CL: 1–6 fps CH: 6 fps • JPEG and 12-bit NEF (RAW) images recorded with 1.3× (18×12) selected for Image area CL: 1–6 fps CH: 7 fps • 14-bit NEF (RAW) images recorded with DX (24×16) selected for Image area CL: 1–5 fps CH: 5 fps • 14-bit NEF (RAW) images recorded with 1.3× (18×12) selected for Image area CL: 1–6 fps CH: 6 fps <p>Note: Maximum frame rate in live view is 3.7 fps.</p>
Self-timer	2 s, 5 s, 10 s, 20 s; 1–9 exposures at intervals of 0.5, 1, 2, or 3 s
Remote control modes (ML-L3)	Delayed remote, quick-response remote, remote mirror-up

Exposure	
Metering	TTL exposure metering using 2016-pixel RGB sensor
Metering method	<ul style="list-style-type: none"> • Matrix: 3D color matrix metering II (type G, E, and D lenses); color matrix metering II (other CPU lenses); color matrix metering available with non-CPU lenses if user provides lens data • Center-weighted: Weight of approximately 75% given to 8 mm circle in center of frame. Diameter of circle can be changed to 6, 10, or 13 mm, or weighting can be based on average of entire frame (non-CPU lenses use 8-mm circle) • Spot: Meters circle with diameter of about 3.5 mm (about 2.5% of frame) centered on selected focus point (on center focus point when non-CPU lens is used)
Range (ISO 100, f/1.4 lens, 20 °C/68 °F)	<ul style="list-style-type: none"> • Matrix or center-weighted metering: 0–20 EV • Spot metering: 2–20 EV
Exposure meter coupling	Combined CPU and AI
Mode	Auto modes (AUTO auto; auto (flash off)); scene modes (portrait; landscape; child; sports; close up; night portrait; night landscape; party/indoor; beach/snow; sunset; dusk/dawn; pet portrait; candlelight; blossom; autumn colors; food); special effects modes (night vision; color sketch; miniature effect; selective color; silhouette; high key; low key); programmed auto with flexible program (P); shutter-priority auto (S); aperture-priority auto (A); manual (M); U1 (user settings 1); U2 (user settings 2)

Exposure	
Exposure compensation	Can be adjusted by -5 – $+5$ EV in increments of $\frac{1}{3}$ or $\frac{1}{2}$ EV in P, S, A, M, SCENE , and  modes
Exposure lock	Luminosity locked at detected value with <small>AE-L AF-L</small> AE-L/AF-L button
ISO sensitivity (Recommended Exposure Index)	ISO 100–25600 in steps of $\frac{1}{3}$ or $\frac{1}{2}$ EV. In P, S, A , and M modes, can also be set to approx. 1 or 2 EV (ISO 102400 equivalent; monochrome only) above ISO 25600; auto ISO sensitivity control available
Active D-Lighting	Auto, Extra high, High, Normal, Low, Off
Focus	
Autofocus	Nikon Advanced Multi-CAM 3500 II autofocus sensor module with TTL phase detection, fine-tuning, 51 focus points (including 15 cross-type sensors; f/8 supported by 1 sensor), and AF-assist illuminator (range approx. 0.5–3 m/1 ft 8 in.–9 ft 10 in.)
Detection range	-3 – $+19$ EV (ISO 100, 20 °C/68 °F)
Lens servo	<ul style="list-style-type: none"> • Autofocus (AF): Single-servo AF (AF-S); continuous-servo AF (AF-C); auto AF-S/AF-C selection (AF-A); predictive focus tracking activated automatically according to subject status • Manual focus (M): Electronic rangefinder can be used
Focus point	Can be selected from 51 or 11 focus points
AF-area mode	Single-point AF; 9-, 21-, or 51-point dynamic-area AF, 3D-tracking, auto-area AF
Focus lock	Focus can be locked by pressing shutter-release button halfway (single-servo AF) or by pressing <small>AE-L AF-L</small> AE-L/AF-L button

Flash	
Built-in flash	 : Auto flash with auto pop-up P, S, A, M, 11 : Manual pop-up with button release
Guide Number	Approx. 12/39, 12/39 with manual flash (m/ft, ISO 100, 20 °C/68 °F)
Flash control	TTL : i-TTL flash control using 2016-pixel RGB sensor is available with built-in flash; i-TTL balanced fill-flash for digital SLR is used with matrix or center-weighted metering, standard i-TTL fill-flash for digital SLR with spot metering
Flash mode	Auto, auto with red-eye reduction, auto slow sync, auto slow sync with red-eye reduction, fill-flash, red-eye reduction, slow sync, slow sync with red-eye reduction, rear-curtain with slow sync, rear-curtain sync, off; Auto FP High-Speed Sync supported
Flash compensation	-3 – +1 EV in increments of 1/3 or 1/2 EV
Flash-ready indicator	Lights when built-in flash or optional flash unit is fully charged; blinks after flash is fired at full output
Accessory shoe	ISO 518 hot-shoe with sync and data contacts and safety lock
Nikon Creative Lighting System (CLS)	Nikon CLS supported; commander mode option available
Sync terminal	AS-15 sync terminal adapter (available separately)

White balance	
White balance	Auto (2 types), incandescent, fluorescent (7 types), direct sunlight, flash, cloudy, shade, preset manual (up to 6 values can be stored, spot white balance measurement available during live view), choose color temperature (2500 K–10,000 K), all with fine-tuning
Bracketing	
Bracketing types	Exposure, flash, white balance, and ADL
Live view	
Modes	📷 (photo live view), 🎬 (movie live view)
Lens servo	<ul style="list-style-type: none"> • Autofocus (AF): Single-servo AF (AF-S); full-time servo AF (AF-F) • Manual focus (M)
AF-area mode	Face-priority AF, wide-area AF, normal-area AF, subject-tracking AF
Autofocus	Contrast-detect AF anywhere in frame (camera selects focus point automatically when face-priority AF or subject-tracking AF is selected)
Movie	
Metering	TTL exposure metering using main image sensor
Metering method	Matrix or center-weighted
Frame size (pixels) and frame rate	<ul style="list-style-type: none"> • 1920 × 1080; 60p (progressive), 50p, 30p, 25p, 24p • 1280 × 720; 60p, 50p <p>Actual frame rates for 60p, 50p, 30p, 25p, and 24p are 59.94, 50, 29.97, 25, and 23.976 fps respectively; options support both ★high and normal image quality</p> <p>1920 × 1080; 60p and 50p are available only when 1.3x (18x12) is selected for Image area in the movie shooting menu</p>

Movie	
File format	MOV
Video compression	H.264/MPEG-4 Advanced Video Coding
Audio recording format	Linear PCM
Audio recording device	Built-in or external stereo microphone; sensitivity adjustable
Other options	Index marking, time-lapse photography
Monitor	
Monitor	8-cm/3.2-in., approx. 1229 k-dot (VGA; 640 × RGBW × 480 = 1,228,800 dots), TFT monitor with approx. 170° viewing angle, approx. 100% frame coverage, and brightness adjustment
Playback	
Playback	Full-frame and thumbnail (4, 9, or 72 images or calendar) playback with playback zoom, movie playback, photo and/or movie slide shows, histogram display, highlights, photo information, location data display, and auto image rotation
Interface	
USB	Hi-Speed USB; connection to built-in USB port is recommended
HDMI output	Type C HDMI connector
Accessory terminal	<ul style="list-style-type: none"> • Wireless remote controllers: WR-1, WR-R10 (available separately) • Remote cord: MC-DC2 (available separately) • GPS unit: GP-1/GP-1A (available separately)
Audio input	Stereo mini-pin jack (3.5 mm diameter; plug-in power supported)
Audio output	Stereo mini-pin jack (3.5 mm diameter)

Wireless	
Standards	IEEE 802.11b, IEEE 802.11g
Operating frequency	2412–2462 MHz (channels 1–11)
Range (line of sight)	Approximately 30 m/98 ft (assumes no interference; range may vary with signal strength and presence or absence of obstacles)
Data rate	54 Mbps Maximum logical data rates according to IEEE standard. Actual rates may differ.
Authentication	Open system, WPA2-PSK
Wireless setup	Supports WPS
Access protocols	Infrastructure
NFC	
Operation	NFC Forum Type 3 Tag
Supported languages	
Supported languages	Arabic, Bengali, Bulgarian, Chinese (Simplified and Traditional), Czech, Danish, Dutch, English, Finnish, French, German, Greek, Hindi, Hungarian, Indonesian, Italian, Japanese, Korean, Marathi, Norwegian, Persian, Polish, Portuguese (Portugal and Brazil), Romanian, Russian, Serbian, Spanish, Swedish, Tamil, Telugu, Thai, Turkish, Ukrainian, Vietnamese

Power source	
Battery	One rechargeable Li-ion EN-EL15 battery; EN-EL15b and EN-EL15a batteries can also be used
Battery pack	Optional MB-D15 multi-power battery pack with one Nikon EN-EL15 rechargeable Li-ion battery or six AA alkaline, Ni-MH, or lithium batteries. EN-EL15b and EN-EL15a batteries can also be used.
AC adapter	EH-5b AC adapter; requires EP-5B power connector (available separately)

Tripod socket	
Tripod socket	1/4 in. (ISO 1222)

Dimensions/weight	
Dimensions (W × H × D)	Approx. 135.5 × 106.5 × 76 mm (5.4 × 4.2 × 3.0 in.)
Weight	Approx. 755 g (1 lb 10.7 oz) with battery and memory card but without body cap; approx. 675 g (1 lb 7.9 oz; camera body only)

Operating environment	
Temperature	0 °C–40 °C (+32 °F–104 °F)
Humidity	85% or less (no condensation)

- Unless otherwise stated, all measurements are performed in conformity with Camera and Imaging Products Association (CIPA) guidelines.
- All figures are for a camera with a fully-charged battery.
- Nikon reserves the right to change the specifications of the hardware and software described in this manual at any time and without prior notice. Nikon will not be held liable for damages that may result from any mistakes that this manual may contain.

■ ■ *MH-25a Battery Charger*

Rated input (in North America)	AC 120 V, 60 Hz, 0.2 A
Rated input (in other regions)	AC 100–240 V, 50/60 Hz, 0.23–0.12 A
Rated output	DC 8.4 V/1.2 A
Supported batteries	Nikon EN-EL15b, EN-EL15a, and EN-EL15 rechargeable Li-ion batteries
Charging time	Approx. 2 hours and 35 minutes at an ambient temperature of 25 °C (77 °F) when no charge remains
Operating temperature	0 °C–40 °C (+32 °F–104 °F)
Dimensions (W × H × D)	Approx. 95 × 33.5 × 71 mm (3.7 × 1.3 × 2.8 in.), excluding projections
Length of power cable (if supplied)	Approx. 1.5 m (4.9 ft)
Weight	Approx. 115 g (4.1 oz), excluding supplied power connector (power cable or AC wall adapter)

■ ■ *EN-EL15 Rechargeable Li-ion Battery*

Type	Rechargeable lithium-ion battery
Rated capacity	7.0 V/1900 mAh
Operating temperature	0 °C–40 °C (+32 °F–104 °F)
Dimensions (W × H × D)	Approx. 40 × 56 × 20.5 mm (1.6 × 2.2 × 0.8 in.)
Weight	Approx. 78 g (2.8 oz), excluding terminal cover

■ AF-S DX NIKKOR 18–105mm f/3.5–5.6G ED VR Lens

Type	Type G AF-S DX lens with built-in CPU and F mount
Focal length	18–105 mm
Maximum aperture	f/3.5–5.6
Lens construction	15 elements in 11 groups (including 1 ED lens element, 1 aspherical lens element)
Angle of view	76°–15° 20′
Focal length scale	Graduated in millimeters (18, 24, 35, 50, 70, 105)
Distance information	Output to camera
Zoom	Manual zoom using independent zoom ring
Focusing	Nikon Internal Focusing (IF) System with autofocus controlled by Silent Wave Motor and separate focus ring for manual focus
Vibration reduction	Lens shift using voice coil motors (VCMs)
Minimum focus distance	0.45 m (1.48 ft) from focal plane (□ 98) at all zoom positions
Diaphragm blades	7 (rounded diaphragm opening)
Diaphragm	Fully automatic
Aperture range	<ul style="list-style-type: none">• 18 mm focal length: f/3.5–22• 105 mm focal length: f/5.6–38 The minimum aperture displayed may vary depending on the size of the exposure increment selected with the camera.
Metering	Full aperture
Filter-attachment size	67 mm (P=0.75 mm)
Dimensions	Approx. 76 mm diameter × 89 mm (distance from camera lens mount flange)
Weight	Approx. 420 g (14.8 oz)

■ AF-S DX NIKKOR 18–140mm f/3.5–5.6G ED VR Lens

Type	Type G AF-S DX lens with built-in CPU and F mount
Focal length	18–140 mm
Maximum aperture	f/3.5–5.6
Lens construction	17 elements in 12 groups (including 1 ED lens element, 1 aspherical lens element)
Angle of view	76°–11° 30′
Focal length scale	Graduated in millimeters (18, 24, 35, 50, 70, 140)
Distance information	Output to camera
Zoom	Manual zoom using independent zoom ring
Focusing	Nikon Internal Focusing (IF) System with autofocus controlled by Silent Wave Motor and separate focus ring for manual focus
Vibration reduction	Lens shift using voice coil motors (VCMs)
Minimum focus distance	0.45 m (1.48 ft) from focal plane (□ 98) at all zoom positions
Diaphragm blades	7 (rounded diaphragm opening)
Diaphragm	Fully automatic
Aperture range	<ul style="list-style-type: none">• 18 mm focal length: f/3.5–22• 140 mm focal length: f/5.6–38 The minimum aperture displayed may vary depending on the size of the exposure increment selected with the camera.
Metering	Full aperture
Filter-attachment size	67 mm (P = 0.75 mm)
Dimensions	Approx. 78 mm maximum diameter × 97 mm (distance from camera lens mount flange)
Weight	Approx. 490 g (17.3 oz)

■ AF-S DX NIKKOR 18–200mm f/3.5–5.6G ED VR II Lens

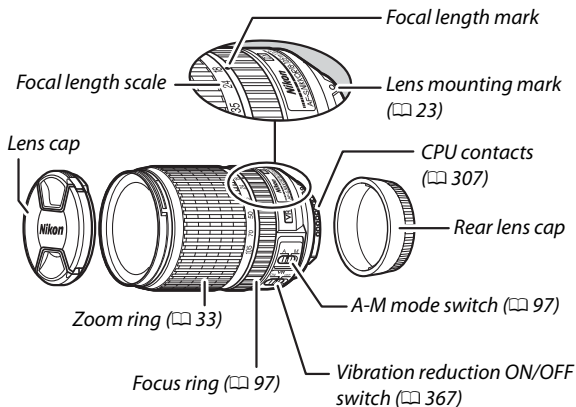
Type	Type G AF-S DX lens with built-in CPU and F mount
Focal length	18–200 mm
Maximum aperture	f/3.5–5.6
Lens construction	16 elements in 12 groups (including 2 ED lens elements, 3 aspherical lens elements)
Angle of view	76°–8°
Focal length scale	Graduated in millimeters (18, 24, 35, 50, 70, 135, 200)
Distance information	Output to camera
Zoom	Manual zoom using independent zoom ring
Focusing	Nikon Internal Focusing (IF) System with autofocus controlled by Silent Wave Motor and separate focus ring for manual focus
Vibration reduction	Lens shift using voice coil motors (VCMs)
Focus distance indicator	0.5 m to infinity (∞)
Minimum focus distance	0.5 m (1.64 ft) from focal plane (□ 98) at all zoom positions
Diaphragm blades	7 (rounded diaphragm opening)
Diaphragm	Fully automatic
Aperture range	<ul style="list-style-type: none">• 18 mm focal length: f/3.5–22• 200 mm focal length: f/5.6–36 The minimum aperture displayed may vary depending on the size of the exposure increment selected with the camera.
Metering	Full aperture
Filter-attachment size	72 mm (P = 0.75 mm)
Dimensions	Approx. 77 mm maximum diameter × 96.5 mm (distance from camera lens mount flange)
Weight	Approx. 565 g (19.9 oz)

Nikon reserves the right to change the specifications of the hardware and software described in this manual at any time and without prior notice. Nikon will not be held liable for damages that may result from any mistakes that this manual may contain.

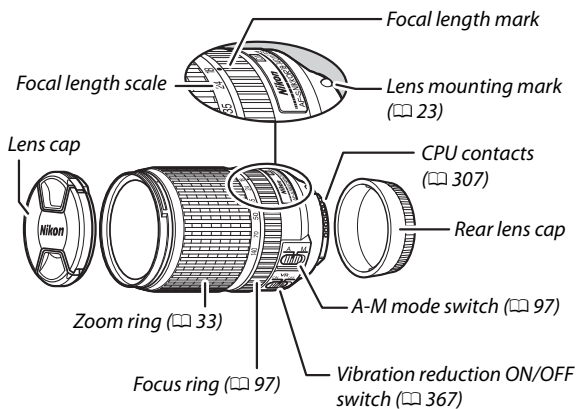
Lenses

This section describes the features available with AF-S DX NIKKOR 18–105mm f/3.5–5.6G ED VR, AF-S DX NIKKOR 18–140mm f/3.5–5.6G ED VR, and AF-S DX NIKKOR 18–200mm f/3.5–5.6G ED VR II lenses. The lens generally used in this manual for illustrative purposes is the AF-S DX NIKKOR 18–105mm f/3.5–5.6G ED VR.

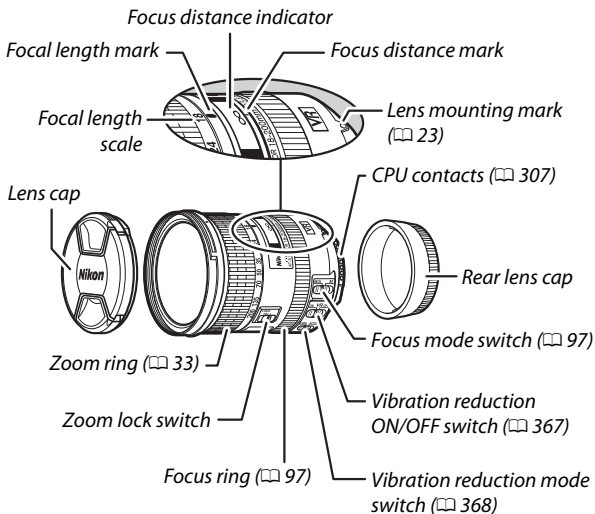
■ AF-S DX NIKKOR 18–105mm f/3.5–5.6G ED VR



■ AF-S DX NIKKOR 18–140mm f/3.5–5.6G ED VR



■ AF-S DX NIKKOR 18–200mm f/3.5–5.6G ED VR II



🔍 Zoom Lock Switch

To lock the zoom ring, rotate it to the 18 mm position and slide the zoom lock switch to **LOCK**. This prevents the lens extending under its own weight while the camera is being carried from place to place.

🔍 Focus Distance Indicator

Note that the focus distance indicator is intended only as a guide and may not accurately show the distance to the subject and may, due to depth of field or other factors, not show ∞ when the camera is focused on a distant object.

The AF-S DX NIKKOR 18–105mm f/3.5–5.6G ED VR, AF-S DX NIKKOR 18–140mm f/3.5–5.6G ED VR, and AF-S DX NIKKOR 18–200mm f/3.5–5.6G ED VR II are for use exclusively with Nikon DX format digital cameras.

✔ Lens Care

- Keep the CPU contacts clean.
- Use a blower to remove dust and lint from the lens surfaces. To remove smudges and fingerprints, apply a small amount of ethanol or lens cleaner to a soft, clean cotton cloth or lens-cleaning tissue and clean from the center outwards using a circular motion, taking care not to leave smears or touch the glass with your fingers.
- Never use organic solvents such as paint thinner or benzene to clean the lens.
- The lens hood or NC filters can be used to protect the front lens element.
- Attach the front and rear caps before placing the lens in its flexible pouch.
- When a lens hood is attached, do not pick up or hold the lens or camera using only the hood.
- If the lens will not be used for an extended period, store it in a cool, dry location to prevent mold and rust. Do not store in direct sunlight or with naphtha or camphor moth balls.
- Keep the lens dry. Rusting of the internal mechanism can cause irreparable damage.
- Leaving the lens in extremely hot locations could damage or warp parts made from reinforced plastic.

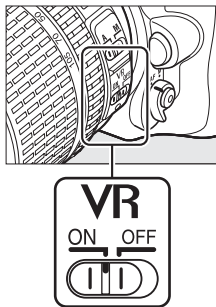
■ ■ **Vibration Reduction (VR)**

The lenses described in this section support vibration reduction (VR), which reduces blur caused by camera shake even when the camera is panned, allowing shutter speeds for DX format cameras to be slowed by approximately 3.5 stops (AF-S DX NIKKOR 18–105mm f/3.5–5.6G ED VR and AF-S DX NIKKOR 18–200mm f/3.5–5.6G ED VR II) or 4.0 stops (AF-S DX NIKKOR 18–140mm f/3.5–5.6G ED VR) at maximum zoom position (according to Camera and Imaging Products Association [CIPA] standards; effects vary with the photographer and shooting conditions). This increases the range of shutter speeds available and permits hand-held, tripod-free photography in a wide range of situations.

To use vibration reduction, slide the vibration reduction switch to **ON**.

Vibration reduction is activated when the shutter-release button is pressed halfway, reducing the effects of camera shake on the image in the viewfinder and simplifying the process of framing the subject and focusing in both autofocus and manual focus modes. When the camera is panned, vibration reduction applies only to motion that is not part of the pan (if the camera is panned horizontally, for example, vibration reduction will be applied only to vertical shake), making it much easier to pan the camera smoothly in a wide arc.

Turn vibration reduction off when the camera is securely mounted on a tripod, but leave it on if the tripod head is not secured or when using a monopod.



✔ Vibration Reduction

Do not turn the camera off or remove the lens while vibration reduction is in effect.

Vibration reduction is disabled while the built-in flash is charging. When vibration reduction is active, the image in the viewfinder may jiggle after the shutter is released. This does not indicate a malfunction; wait for the image in the viewfinder to stabilize before shooting.

🔧 The Vibration Reduction Mode Switch (AF-S DX NIKKOR 18–200mm f/3.5–5.6G ED VR II Lenses)

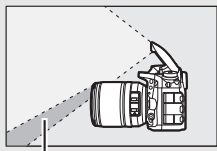
The vibration reduction mode switch is used to select the vibration reduction mode when vibration reduction is on.

- **Select NORMAL** to reduce the effects of vibration when photographing from a fixed position and in other situations with comparatively little camera motion.
- **Select ACTIVE** to reduce the effects of vibration when shooting from a moving vehicle, while walking, and in other situations with active camera motion.

Slide the vibration reduction mode switch to **NORMAL** for panning shots. When the camera is panned, vibration reduction applies only to motion that is not part of the pan (if the camera is panned horizontally, for example, vibration reduction will be applied only to vertical shake), making it much easier to pan the camera smoothly in a wide arc.

Using the Built-in Flash

When using the built-in flash, be sure the subject is at a range of at least 0.6 m (2 ft) and remove lens hoods to prevent vignetting (shadows created where the end of the lens obscures the built-in flash).



Shadow



Vignetting

AF-S DX NIKKOR 18–105mm f/3.5–5.6G ED VR:

Camera	Zoom position	Minimum distance without vignetting
D5300/D5000/D3100/ D3000	18 mm	2.5 m/8 ft 2 in.
	24 mm	1.0 m/3 ft 3 in.
D5200/D5100/D3200	18 mm	3.0 m/9 ft 10 in.
	24 mm	1.0 m/3 ft 3 in.
D5500/D3300	18 mm	2.5 m/8 ft 2 in.
	24 mm	1.0 m/3 ft 3 in.
	35–105 mm	No vignetting
D7200/D7100/D7000/ D300 series/D200/D100/ D80	All	No vignetting
D90/D70 series	18 mm	1.5 m/4 ft 11 in.
	24–105 mm	No vignetting
D50	18 mm	1.0 m/3 ft 3 in.
	24–105 mm	No vignetting
D60/D40 series	18 mm	2.5 m/8 ft 2 in.
	24 mm	1.0 m/3 ft 3 in.
	35–105 mm	No vignetting

AF-S DX NIKKOR 18–140mm f/3.5–5.6G ED VR:

Camera	Zoom position	Minimum distance without vignetting
D7200/D7100/D7000/ D300 series/D200/D100	18 mm	1.0 m/3 ft 3 in.
	24–140 mm	No vignetting
D90/D80/D50	18 mm	2.5 m/8 ft 2 in.
	24 mm	1.0 m/3 ft 3 in.
	35–140 mm	No vignetting
D5500/D5300/D5200/ D5100/D5000/D3300/ D3200/D3100/D3000/ D70 series/D60/D40 series	18 mm	1.0 m/3 ft 3 in.
	24 mm	1.0 m/3 ft 3 in.
	35–140 mm	No vignetting

AF-S DX NIKKOR 18–200mm f/3.5–5.6G ED VR II:

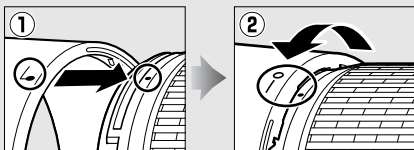
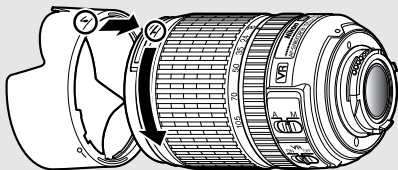
Camera	Zoom position	Minimum distance without vignetting
D7200/D7100/D7000/ D300 series/D200/D100	18 mm	1.0 m/3 ft 3 in.
	24–200 mm	No vignetting
D90/D80	24 mm	1.0 m/3 ft 3 in.
	35 mm	1.0 m/3 ft 3 in.
	50–200 mm	No vignetting
D5500/D5300/D5200/ D5100/D5000/D3300/ D3200/D3100/D3000/ D70 series/D60/D50/ D40 series	24 mm	1.0 m/3 ft 3 in.
	35–200 mm	No vignetting

Because the built-in flash units for the D100 and D70 can only cover the angle of view of a lens with a focal of 20 mm or more; vignetting will occur at a focal length of 18 mm.

Supplied Accessories for AF-S DX NIKKOR 18–105mm f/3.5–5.6G ED VR

- 67 mm Snap-on Front Lens Cap LC-67
- Rear Lens Cap
- Flexible Lens Pouch CL-1018
- Bayonet Hood HB-32

Align the lens hood mounting mark (●) with the lens hood alignment mark (◐) as shown in Figure ① and then rotate the hood (②) until the ● mark is aligned with the lens hood lock mark (—○).



When attaching or removing the hood, hold it near the symbol on its base and avoid gripping it too tightly. Vignetting may occur if the hood is not correctly attached.

The hood can be reversed and mounted on the lens when not in use.

Optional Accessories for AF-S DX NIKKOR 18–105mm f/3.5–5.6G ED VR

- 67 mm screw-on filters
- LF-1 and LF-4 rear lens caps

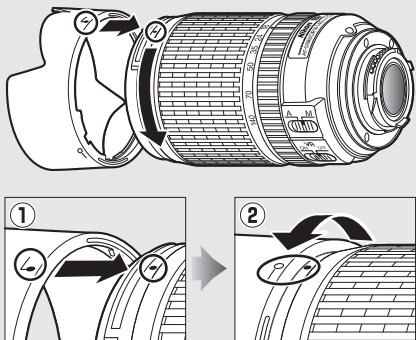
Supplied Accessories for AF-S DX NIKKOR 18–140mm f/3.5–5.6G ED VR

- 67 mm snap-on Front Lens Cap LC-67
- Rear Lens Cap

Optional Accessories for AF-S DX NIKKOR 18–140mm f/3.5–5.6G ED VR

- 67 mm screw-on filters
- LF-1 and LF-4 rear lens caps
- Flexible Lens Pouch CL-1018
- Bayonet Hood HB-32

Align the lens hood mounting mark (●) with the lens hood alignment mark (◡) as shown in Figure ① and then rotate the hood (②) until the ● mark is aligned with the lens hood lock mark (—○).



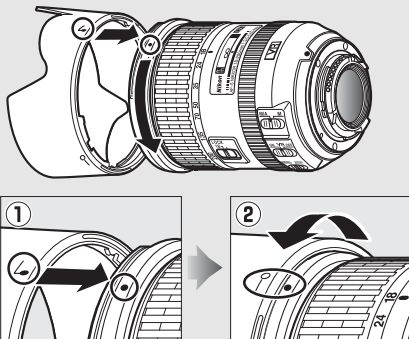
When attaching or removing the hood, hold it near the symbol on its base and avoid gripping it too tightly. Vignetting may occur if the hood is not correctly attached.

The hood can be reversed and mounted on the lens when not in use.

Supplied Accessories for AF-S DX NIKKOR 18–200mm f/3.5–5.6G ED VR II

- 72 mm Snap-on Front Lens Cap LC-72
- Rear Lens Cap
- Flexible Lens Pouch CL-1018
- Bayonet Hood HB-35

Align the lens hood mounting mark (●) with the lens hood alignment mark (◡) as shown in Figure ① and then rotate the hood (②) until the ● mark is aligned with the lens hood lock mark (—○).



When attaching or removing the hood, hold it near the symbol on its base and avoid gripping it too tightly. Vignetting may occur if the hood is not correctly attached.

The hood can be reversed and mounted on the lens when not in use.

Optional Accessories for AF-S DX NIKKOR 18–200mm f/3.5–5.6G ED VR II

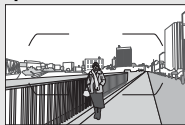
- 72 mm screw-on filters
- LF-1 and LF-4 rear lens caps

A Note on Wide- and Super Wide-Angle Lenses

Autofocus may not provide the desired results in situations like those shown below.

1 Objects in the background occupy more of the focus point than the main subject:

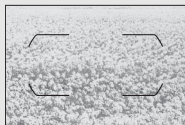
If the focus point contains both foreground and background objects, the camera may focus on the background and the subject may be out of focus.



Example: *A far-off portrait subject at some distance from the background*

2 The subject contains many fine details.

The camera may have difficulty focusing on subjects that lack contrast or appear smaller than objects in the background.



Example: *A field of flowers*

In these cases, use manual focus, or use focus lock to focus on another subject at the same distance and then recompose the photograph. For more information, see “Getting Good Results with Autofocus” (□ 96).

🔍 Using M/A (Autofocus with Manual Override) with AF-S DX NIKKOR 18–200mm f/3.5–5.6G ED VR II Lenses

To focus using autofocus with manual override (M/A):

- 1 Slide the lens focus-mode switch (☐ 365) to M/A.
- 2 Focus.

If desired, you can over-ride autofocus by rotating the lens focus ring while keeping the shutter-release button pressed halfway (or while pressing the button to which AF-ON has been assigned in the Custom Settings menu). To refocus using autofocus, press the shutter-release button halfway (or press the button again).

🔍 Focusing with AF-S DX NIKKOR 18–105mm f/3.5–5.6G ED VR and AF-S DX NIKKOR 18–140mm f/3.5–5.6G ED VR Lenses

When single-servo AF (AF-S) is selected as the camera focus mode and the lens A-M switch is set to **A**, focus can be adjusted by keeping the shutter-release button pressed halfway after the autofocus operation is complete and manually rotating the focus ring. Do not rotate the focus ring until the autofocus operation is complete. To refocus using autofocus, press the shutter-release button halfway again.

■ ■ *Supported Standards*

- **DCF Version 2.0:** The Design Rule for Camera File Systems (DCF) is a standard widely used in the digital camera industry to ensure compatibility among different makes of camera.
- **DPOF:** Digital Print Order Format (DPOF) is an industry-wide standard that allows pictures to be printed from print orders stored on the memory card.
- **Exif version 2.3:** The camera supports Exif (Exchangeable Image File Format for Digital Still Cameras) version 2.3, a standard in which information stored with photographs is used for optimal color reproduction when the images are output on Exif-compliant printers.
- **PictBridge:** A standard developed through cooperation with the digital camera and printer industries, allowing photographs to be output directly to a printer without first transferring them to a computer.
- **HDMI:** High-Definition Multimedia Interface is a standard for multimedia interfaces used in consumer electronics and AV devices capable of transmitting audiovisual data and control signals to HDMI-compliant devices via a single cable connection.

Trademark Information

IOS is a trademark or registered trademark of Cisco Systems, Inc., in the United States and/or other countries and is used under license.

Windows is either a registered trademark or a trademark of Microsoft Corporation in the United States and/or other countries. PictBridge is a trademark. The SD, SDHC, and SDXC logos are trademarks of the SD-3C, LLC. HDMI, the HDMI logo and High-Definition Multimedia Interface are trademarks or registered trademarks of HDMI Licensing, LLC.

HDMI

Wi-Fi and the Wi-Fi logo are trademarks or registered trademarks of the Wi-Fi Alliance. N-Mark is a trademark or registered trademark of NFC Forum, Inc., in the United States and/or other countries. All other trade names mentioned in this manual or the other documentation provided with your Nikon product are trademarks or registered trademarks of their respective holders.

Conformity Marking

The standards with which the camera complies can be viewed using the **Conformity marking** option in the setup menu (☐ 293).

FreeType License (FreeType2)

Portions of this software are copyright © 2012 The FreeType Project (<http://www.freetype.org>). All rights reserved.

MIT License (HarfBuzz)

Portions of this software are copyright © 2015 The HarfBuzz Project (<http://www.freedesktop.org/wiki/Software/HarfBuzz>). All rights reserved.

Certificates

• Indonesia

37921/SDPPI/2014
4588

37920/SDPPI/2014
4593

• México

COFETEL: RCPMULB13-0954
LBWA1U5YR1

• Paraguay

Número del Registro: 2014-01-I-00028

Este producto contiene un transmisor
aprobado por la CONATEL.

• Brasil



(01)0789857980 048 9

الأردن •
TRC/LPD/2013/141
الإمارات العربية المتحدة •

TRA
REGISTERED No:
ER47249/16
DEALER No:
DA0073692/11

Approved Memory Cards

The camera supports SD, SDHC, and SDXC memory cards, including SDHC and SDXC cards compliant with UHS-I. Cards rated SD Speed Class 6 or better are recommended for movie recording; using slower cards may result in recording being interrupted. When choosing cards for use in card readers, be sure they are compatible with the device. Contact the manufacturer for information on features, operation, and limitations on use.



Memory Card Capacity

The following table shows the approximate number of pictures that can be stored on a 16 GB SanDisk Extreme Pro 95 MB/s UHS-I SDHC card at different image quality (☐ 77), image size (☐ 81), and image area settings (as of March 2015; ☐ 73).

■ DX (24×16) Image Area

Image quality	Image size	File size ¹	No. of images ¹	Buffer capacity ²
NEF (RAW), Lossless compressed, 12-bit	—	22.2 MB	379	27
NEF (RAW), Lossless compressed, 14-bit	—	28.0 MB	294	18
NEF (RAW), Compressed, 12-bit	—	20.6 MB	511	35
NEF (RAW), Compressed, 14-bit	—	25.4 MB	428	26
JPEG fine ³	Large	12.7 MB	929	100
	Medium	7.7 MB	1500	100
	Small	3.9 MB	2900	100
JPEG normal ³	Large	6.5 MB	1800	100
	Medium	3.9 MB	3000	100
	Small	2.1 MB	5600	100
JPEG basic ³	Large	2.7 MB	3500	100
	Medium	1.9 MB	5700	100
	Small	1.1 MB	10,300	100

■ 1.3× (18×12) Image Area

Image quality	Image size	File size ¹	No. of images ¹	Buffer capacity ²
NEF (RAW), Lossless compressed, 12-bit	—	15.0 MB	575	44
NEF (RAW), Lossless compressed, 14-bit	—	18.7 MB	449	29
NEF (RAW), Compressed, 12-bit	—	13.8 MB	770	67
NEF (RAW), Compressed, 14-bit	—	16.9 MB	648	46
JPEG fine ³	Large	8.6 MB	1300	100
	Medium	5.3 MB	2200	100
	Small	2.9 MB	4000	100
JPEG normal ³	Large	4.3 MB	2600	100
	Medium	2.8 MB	4300	100
	Small	1.5 MB	7400	100
JPEG basic ³	Large	2.0 MB	5100	100
	Medium	1.4 MB	7900	100
	Small	0.9 MB	13,100	100

1 All figures are approximate. File size varies with scene recorded.

2 Maximum number of exposures that can be stored in memory buffer at ISO 100. Drops if **Optimal quality** is selected for **JPEG compression** (□ 80), ISO sensitivity is set to 12800 or higher, or long exposure noise reduction or auto distortion control is on.

3 Figures assume **JPEG compression** is set to **Size priority**. Selecting **Optimal quality** increases the file size of JPEG images; number of images and buffer capacity drop accordingly.

📷 d3—Max. Continuous Release (□ 280)

The maximum number of photographs that can be taken in a single burst can be set to any amount between 1 and 100.

Battery Life

The movie footage or number of shots that can be recorded with fully-charged batteries varies with the condition of the battery, temperature, interval between shots, and the length of time menus are displayed. In the case of AA batteries, capacity also varies with make and storage conditions; some batteries can not be used. Sample figures for the camera and optional MB-D15 multi-power battery pack are given below.

- **Photographs, single-frame release mode (CIPA standard ¹)**

- **One EN-EL15 battery ² (camera):** Approximately 1110 shots

- **One EN-EL15 battery ² (MB-D15):** Approximately 1110 shots

- **Six AA alkaline batteries (MB-D15):** Approximately 630 shots

- **Photographs, continuous release mode (Nikon standard ³)**

- **One EN-EL15 battery ² (camera):** Approximately 4090 shots

- **One EN-EL15 battery ² (MB-D15):** Approximately 4090 shots

- **Six AA alkaline batteries (MB-D15):** Approximately 1510 shots

- **Movies ⁴**

- **One EN-EL15 battery ² (camera):** Approximately 80 minutes of HD footage

- **One EN-EL15 battery ² (MB-D15):** Approximately 80 minutes of HD footage

- **Six AA alkaline batteries (MB-D15):** Approximately 30 minutes of HD footage

- 1 Measured at 23 °C/73.4 °F (± 2 °C/3.6 °F) with an AF-S DX NIKKOR 18–105mm f/3.5–5.6G ED VR lens under the following test conditions: lens cycled from infinity to minimum range and one photograph taken at default settings once every 30 s; flash fired once every other shot. Live view not used.
- 2 EN-EL15b and EN-EL15a batteries can also be used in place of the EN-EL15.
- 3 Measured at 20 °C/68 °F with an AF-S DX NIKKOR 18–105mm f/3.5–5.6G ED VR lens under the following test conditions: image quality set to JPEG basic, image size set to **M** (medium), shutter speed $\frac{1}{250}$ s, shutter-release button pressed halfway for three seconds and focus cycled from infinity to minimum range three times; six shots are then taken in succession and monitor turned on for five seconds and then turned off; cycle repeated once standby timer expires.
- 4 Measured at 23 °C/73.4 °F (± 2 °C/3.6 °F) with the camera at default settings and an AF-S DX NIKKOR 18–105mm f/3.5–5.6G ED VR lens under conditions specified by the Camera and Imaging Products Association (CIPA). Individual movies can be up to 29 minutes and 59 seconds (1080/30p) in length or 4 GB in size; recording may end before these limits are reached if the camera temperature rises.

The following can reduce battery life:

- Using the monitor
- Keeping the shutter-release button pressed halfway
- Repeated autofocus operations
- Taking NEF (RAW) photographs
- Slow shutter speeds
- Using camera Wi-Fi (wireless LAN) features
- Using the camera with optional accessories
- Using VR (vibration reduction) mode with VR lenses

To ensure that you get the most from Nikon EN-EL15 rechargeable Li-ion batteries:

- Keep the battery contacts clean. Soiled contacts can reduce battery performance.
- Use batteries immediately after charging. Batteries will lose their charge if left unused.

Index

Symbols

(Auto mode)	30
(Auto (flash off) mode).....	30
SCENE (Scene mode)	41
EFFECTS (Special effects)	44
(Portrait)	42
(Landscape).....	42
(Child).....	42
(Sports).....	42
(Close up).....	42
(Night portrait).....	42
(Night landscape).....	42
(Party/indoor)	42
(Beach/snow).....	42
(Sunset).....	43
(Dusk/dawn)	43
(Pet portrait)	43
(Candlelight).....	43
(Blossom).....	43
(Autumn colors).....	43
(Food).....	43
(Night vision)	44
(Color sketch).....	44, 46
(Miniature effect).....	45, 47
(Selective color).....	45, 49
(Silhouette).....	45
(High key).....	45
(Low key)	45
P (Programmed auto)	52
S (Shutter-priority auto)	53
A (Aperture-priority auto).....	54
M (Manual)	56
U1/U2	62
S (Single frame)	66
CL (Continuous low speed).....	66
CH (Continuous high speed).....	66
Q (Quiet shutter-release).....	66

(Self-timer)	66, 69
MUP (Mirror up)	66, 71
(Face-priority AF).....	88
(Wide-area AF)	88
(Normal-area AF).....	88
(Subject-tracking AF)	89
(Matrix)	105
(Center-weighted).....	105
(Spot).....	105
AUTO (Auto flash)	145
(Red-eye reduction).....	145, 147
SLOW (Slow sync)	145, 147
REAR (Rear-curtain sync).....	147
(Exposure compensation).....	109
(Flash compensation).....	151
(Flexible program).....	52
(Live view) button.....	12, 31, 161
i button	189, 233
(Info) button	13, 185
(OK) button	17, 284
switch	5
PRE (Preset manual)	111, 120
BKT (Bracketing).....	197
(Focus indicator)	34, 93, 98
(Memory buffer).....	68
(Flash-ready indicator).....	36

Numerics

1.3x (18x12)	73, 168, 169
12-bit.....	80
14-bit.....	80
3D-tracking	87, 90

A

AC adapter	319
Accessories.....	319
Active D-Lighting.....	139, 207, 270
ADL bracketing.....	207

AE & flash (Auto bracketing set) . 197
 AE lock..... 107
 AE only (Auto bracketing set) 197
AE-L/AF-L button..... 94, 107, 285, 288
 AF..... 83–95
 AF activation..... 277
 AF area brackets 10, 25, 235
 AF fine-tune..... 292
 AF-A.....83
 AF-area mode86
 AF-assist.....277, 317
 AF-C..... 83, 276
 AF-F84
 AF-mode button.....84, 90
 AF-S 83, 84, 276
 After delete..... 267
 Angle of view 310
 Aperture 54–56
 Aperture-priority auto54
 Aspect ratio 298
 Auto (White balance)111, 112
 Auto bracketing..... 197, 284
 Auto distortion control 271
 Auto flash 145
 Auto image rotation..... 290
 Auto ISO sensitivity control 102
 Auto-area AF87, 90
 Autoexposure lock..... 107
 Autofocus..... 83–95
 Autofocus mode83
 Auto-servo AF83

B

Backlight..... 5
 Backup (Role played by card in Slot
 2).....82
 Battery21, 22, 26, 291, 359
 Battery life..... 382
 Battery pack 319
 Beep 280
 Body cap.....3, 319

Bracketing 197, 284
 Built-in flash36, 144
 Bulb..... 58, 59

C

Calendar playback.....232
 Camera Control Pro 2.....319
 Capture NX-Dii
 Center-weighted..... 105, 278
 Charging the battery 21
 Choose color temp. (White balance)
 111, 117
 Choose start/end point179
 Clean image sensor.....321
 Clock battery188
 Cloudy (White balance)111
 CLS.....311
 Color outline.....295
 Color sketch44, 46, 295
 Color space.....270
 Color temperature..... 111, 113, 117
 Command dial285
 Communication unit319
 Compatible lenses.....304
 Compressed (Type)80
 Conformity marking 293, 377
 Connector for external microphone.
 2
 Continuous high speed66
 Continuous low speed.....66, 280
 Continuous release mode66
 Continuous-servo AF.....83
 Control panel.....9
 Copy image(s)267
 Copyright..... 240, 291
 CPU contacts307
 CPU lens29, 304
 Creative Lighting System311
 Custom Settings.....276

D

Date and time.....	24, 290
DCF.....	376
Default settings.....	194
Delayed remote (Remote control mode (ML-L3)).....	156
Delete.....	40, 246
Delete all images.....	248
Delete current image.....	40, 246
Delete selected images.....	248
Depth-of-field.....	55
Destination.....	192, 273
Digital Print Order Format.....	376
Diopter adjustment control.....	25, 319, 333
Direct sunlight (White balance)..	111
Distortion control.....	295
D-Lighting.....	294
DPOF.....	267, 376
DX (24×16).....	73, 168, 169
Dynamic-area AF.....	86, 90

E

Edit movie.....	179, 233, 296
Electronic rangefinder.....	98
EV steps for exposure cntrl.....	278
Exif.....	376
Exposure.....	105–110
Exposure bracketing.....	197
Exposure compensation.....	109, 278, 283
Exposure delay mode.....	280
Exposure indicator.....	57, 286
Exposure lock.....	107
Exposure meters.....	37
External microphone.....	193
Eye-Fi upload.....	293

F

Face-priority AF.....	88
-----------------------	----

File naming.....	268, 273
File number sequence.....	280
Filter effects.....	134, 294
Fine-tune optimal exposure.....	278
Fine-tuning white balance.....	114
Firmware version.....	293
Fisheye.....	295
Flash.....	36, 144, 145, 151, 153, 311
Flash (White balance).....	111
Flash bracketing.....	197
Flash cntrl for built-in flash.....	283
Flash compensation.....	151
Flash mode.....	145, 147
Flash only (Auto bracketing set).....	197
Flash range.....	150
Flash ready indicator.....	36, 154, 280, 316
Flash shutter speed.....	148, 283
Flash sync speed.....	282, 351
Flat (Set Picture Control).....	130
Flexible program.....	52
Flicker reduction.....	290
Fluorescent (White balance).....	111
Fn button.....	76, 284, 288
f-number.....	52, 54, 307
Focal length.....	225, 309
Focal length scale.....	363, 364, 365
Focal plane mark.....	98
Focus indicator.....	34, 93, 98
Focus lock.....	93
Focus mode.....	83
Focus point.....	33, 34, 86, 89, 98, 277
Focus tracking.....	85, 276
Focusing screen.....	350
Focus-mode selector.....	83
Format memory card.....	289
Frame size/frame rate.....	166, 192, 273
Framing guides.....	13, 14
Frequency response.....	192, 274
Front-curtain sync.....	147
Full-frame playback.....	229

Full-time servo AF	84
FV lock	153

G

GPS	227, 241
-----------	----------

H

H.264	356
HDMI	170, 292, 376
HDMI connector	2
Headphone volume	193
Headphones	193
Help	17
Hi ISO command dial access	101
Hide image	266
High definition	376
High Dynamic Range (HDR)	141, 270
High ISO NR	271, 275
Highlight display	193
Highlights	236
Histogram	237, 238

I

Image area . 73, 75, 81, 168, 169, 269, 274	
Image comment	291
Image Dust Off ref photo	290
Image overlay	294, 299
Image quality	77, 268
Image review	176, 230, 267
Image size	81, 169, 269
Incandescent (White balance)	111
Index marking	167, 178
In-focus indicator	34, 93, 98
Information	185, 234
Information display	13, 185, 281
Interval timer shooting	217, 272
ISO sensitivity	99, 102, 281
ISO sensitivity settings	102, 271
ISO sensitivity step value	278
i-TTL	149

J

JPEG	77, 80
JPEG basic	77
JPEG compression	80, 269
JPEG fine	77
JPEG normal	77

L

L (large)	81, 169
LAN adapters	319
Landscape (Set Picture Control)	130
Language	290, 357
LCD illumination	5, 281
Lens	23, 29, 224, 304, 363
Lens focus ring	97, 363, 364, 365
Lens mount	3, 98
Lens vibration reduction switch	367
Live view	31, 161–170
Live view selector	31, 161
Location data	227, 241
Lock mirror up for cleaning	324
Long exposure NR	271
Lossless compressed (Type)	80

M

M (medium)	81, 169
Manage Picture Control	135, 270, 275
Manual	56, 97
Manual focus	97
Matrix metering	105
Max. continuous release	280
Maximum aperture	150, 307, 317
Maximum sensitivity	103
MB-D15	281, 286, 319
Memory buffer	68
Memory card	22, 27, 82, 379, 380
Memory card capacity	380
Metering	105
Microphone	193

Microphone sensitivity	192, 273
Miniature effect	45, 47, 296
Minimum aperture	29, 51
Minimum shutter speed	103
Mired	116
Mirror	71, 156, 324
Mirror up	66, 71
Mode dial	6
Mode dial lock release	6
Modeling flash	55, 284
Monitor	12, 39, 229
Monitor brightness.....	191, 192, 289
Monitor color balance	290
Monitor off delay.....	279
Monitor pre-flash	149, 154
Monochrome	130, 294
Mounting mark.....	363, 364, 365
Movie ISO sensitivity settings.....	275
Movie live view	161
Movie quality	166, 192, 273
Movie shooting menu	273
Movie-record button	163, 286
Movies.....	161
Multiple exposure	211, 272
MY MENU	297

N

NEF (RAW).....	77, 80, 302
NEF (RAW) bit depth	80
NEF (RAW) processing	295, 302
NEF (RAW) recording	80, 269
Network.....	293
Neutral (Set Picture Control).....	130
NFC.....	254, 264
Non-CPU lens.....	224, 305, 308
Non-CPU lens data.....	224
Normal-area AF.....	88
Number of focus points.....	277
Number of shots.....	382

O

OK button.....	17, 284
Optimal quality (JPEG compression). 80	
Optional flash.....	283, 311
Overflow (Role played by card in Slot 2)	82
Overview data.....	242

P

Perspective control	296
Photo information.....	234
Photo shooting menu.....	268
PictBridge	376
Picture Controls.....	130, 132
Picture size	310
Playback.....	39, 229
Playback display options	234, 266
Playback folder	266
Playback information	234
Playback menu	266
Playback slot and folder	233
Playback zoom.....	243
Portrait (Set Picture Control)	130
Power connector	319
Predictive focus tracking	85
Preset manual (White balance)....	111, 120
Press the shutter-release button all the way down	35
Press the shutter-release button halfway	34
Preview button.....	55, 167, 285, 288
Programmed auto	52
Protecting photographs	245
Pv button.....	55, 167, 285, 288

Q

Quick retouch	295
---------------------	-----

Quick-response remote (Remote control mode (ML-L3))..... 156
Quiet shutter-release66

R

RAW Slot 1 - JPEG Slot 2 (Role played by card in Slot 2)82
Rear-curtain sync..... 147
RECENT SETTINGS 297
Red-eye correction 294
Red-eye reduction 145, 147
Release button to use dial..... 285
Release mode 8, 66
Release mode dial..... 8, 66
Release mode dial lock release . 8, 66
Remote control 156, 319
Remote control mode (ML-L3) ... 156, 272
Remote cord.....58
Remote mirror-up (Remote control mode (ML-L3)) 156
Remote on duration (ML-L3)..... 279
Removing the lens from the camera 29
Reset 194
Reset custom settings 276
Reset movie shooting menu 273
Reset photo shooting menu 268
Reset user settings.....65
Resize..... 295
Restoring default settings..... 194
Retouch menu.....233, 294
Reverse indicators 286
RGB..... 237
Role played by card in Slot 2. 82, 268
Rotate tall..... 267

S

S (small) 81, 169
Save selected frame 179, 183
Save user settings62

Save/load settings.....291
Scene mode 41
SD memory card. 22, 27, 82, 379, 380
Select date..... 249, 266
Select to send to smart device/
deselect 233, 263
Selective color.....45, 49, 296
Self-timer66, 69, 279
Sensitivity99, 102
Set clock from satellite.....227
Set Picture Control 130, 270, 275
Setup menu289
Shade (White balance).....111
Shooting data239
Shutter speed..... 53, 56
Shutter-priority auto..... 53
Shutter-release button35, 93, 107, 279, 288
Shutter-release button AE-L279
Side-by-side comparison296
Single frame..... 66
Single-point AF..... 86, 90
Single-servo AF..... 83, 84
Size81, 169
Size priority (JPEG compression)... 80
Slide show267
Slot27, 82, 233
Slot empty release lock.....286
Slow sync 145, 147
Smart device250
Speaker.....4
Special effects 44
Speedlight.....311
Spot.....105
Spot white balance124
SSID.....251
Standard (Set Picture Control) 130
Standard i-TTL fill-flash for digital SLR..... 149, 313
Standby timer 37, 227, 279
Storage folder268

Store points by orientation	277
Straighten	295
Subject-tracking AF	89

T

Thumbnail playback	231
Time	24, 58, 60, 290
Time zone and date.....	24, 290
Time-lapse photography.....	171, 275
Timer.....	69, 217
Toning.....	133, 135
Trim	294, 298
Trimming movies.....	179
Tripod.....	3
Two-button reset	194
Type D lens.....	304, 307
Type E lens.....	304, 307
Type G lens	304, 307

U

User settings	62
UT-1	319
UTC.....	228, 241

V

Vibration reduction	367
View SSID	251
Viewfinder	10, 25, 319, 349
Viewfinder eyepiece	70
Viewfinder eyepiece cap.....	70
Viewfinder focus.....	25, 319
Viewfinder grid display	280
ViewNX-i.....	ii
Vignette control	271
Virtual horizon.....	13, 14, 291
Vivid (Set Picture Control).....	130
Volume.....	178

W

WB (White balance).....	111, 202
-------------------------	----------

WB bracketing (Auto bracketing set) 202	
White balance	111, 202, 269, 274
Wide-area AF	88
Wi-Fi.....	250
Wind noise reduction.....	192, 274
Wireless Mobile Utility	250, 251
Wireless network	250, 319
Wireless remote controller .	160, 287, 319
Wireless transmitter.....	319
WT-5	319







Warranty Terms - Nikon Europe Service Warranty

Dear Nikon Customer,

We thank you for your purchasing this Nikon product. Should your Nikon product require warranty service, please contact the dealer from whom it was purchased or a member of our authorized service network within the sales territory of Nikon Europe B.V. (e.g. Europe/Russia/others). See details under: <http://www.europe-nikon.com/support>

In order to avoid any unnecessary inconvenience, we advise you to read the user manuals carefully before contacting the dealer or our authorized service network.

Your Nikon equipment is guaranteed against any manufacturing defects for one full year from the date of original purchase. If during this period of guarantee the product proves defective due to improper material or workmanship, our authorized service network within the sales territory of Nikon Europe B.V. will, without charge for labor and parts, repair the product in the terms and conditions set as below. Nikon reserves the right (at its sole discretion) to replace or repair the product.

1. This warranty is only provided upon presentation of the completed warranty card and original invoice or purchase receipt indicating the date of purchase, product type and dealer's name, together with the product. Nikon reserves the right to refuse free-of-charge warranty service if the above documents cannot be presented or if the information contained in it is incomplete or illegible.

2. This warranty will not cover:

- necessary maintenance and repair or replacement of parts due to normal wear and tear.
- modifications to upgrade the product from its normal purpose as described in user manuals, without the prior written consent of Nikon.
- transport costs and all risks of transport relating directly or indirectly to the warranty of the products.
- any damage resulting from modifications or adjustments which may be made to the product, without the prior written consent of Nikon, in order to comply with local or national technical standards in force in any other country than the ones for which the product was originally designed and/or manufactured.

3. The warranty will not be applicable in the case of:

- damage caused by misuse including but not limited to failure to use the product for its normal purpose or according to the user instructions on the proper use and maintenance, and to installation or use of the product inconsistent with the safety standards in force in the country where it is used.
- damage caused by accidents including but not limited to lightning, water, fire, misuse or neglect.
- defacing, illegibility or removal of the model or serial number on the product.
- damage resulting from repairs or adjustments which have been conducted by unauthorized service organizations or persons.
- defects in any system into which the product is incorporated or with which it is used.

4. This service warranty does not affect the consumer's statutory rights under applicable national laws in force, nor the consumer's right against the dealer arising from their sales/ purchase contract.

Notice: An overview of all authorized Nikon Service Stations can be found online by following this Link
(URL = <http://www.europe-nikon.com/service/>).



Nikon Europe Service Warranty Card

Model name

Nikon D7200

Serial No.

Purchase date

■ Name and address of customer

■ Dealer

■ Distributor

Nikon Europe B.V.
Tripolis 100, Burgerweeshuispad 101,
1076 ER Amsterdam, The Netherlands

■ Manufacturer

NIKON CORPORATION
Shinagawa Intercity Tower C, 2-15-3, Konan,
Minato-ku, Tokyo 108-6290 Japan

No reproduction in any form of this manual, in whole or in part (except for brief quotation in critical articles or reviews), may be made without written authorization from NIKON CORPORATION.

NIKON CORPORATION

© 2015 Nikon Corporation

AMA16323

Printed in Europe



SB9A04(11)
6MB27211-04