

Nikon

DIGITAL CAMERA

COOLPIX B600

Quick Start Guide

Introduction	ii
Parts of the Camera	1
Getting Started	2
Basic Shooting and Playback Operations	7
Other Functions	12
If There Is a Problem	16
Technical Notes	17

En

- Read this manual thoroughly before using the camera.
- To ensure proper use of the camera, be sure to read “For Your Safety” (page vii).
- After reading this manual, keep it in a readily accessible place for future reference.

Introduction

Read This First

The following manuals are available for this camera.

For Basic Usage

Quick Start Guide (this document): Explains preparation for shooting and basic operations.

For Detailed Usage

Reference Manual (PDF format): Detailed manual that can be downloaded from our Download Center to a computer or smart device. It can be viewed using Adobe Acrobat Reader (downloadable from the Adobe website).

The following descriptions are included in the manual.

- Detailed explanations for shooting functions, playback functions, and menu items
- Connecting the camera to a TV, printer, or computer
- Compatible accessories
- Solutions when there is a problem or an error message is displayed

Connecting to a Smart Device

SnapBridge Connection Guide: Explains how to connect the camera with smart devices. You can download the latest version (PDF format) from our Download Center.

See the “Reference Manual” for more information about setting the camera.

SnapBridge online help: Explains details about using the SnapBridge app.

<https://nikonimglib.com/snbr/onlinehelp/en/index.html>

Visit Our Download Center

<https://downloadcenter.nikonimglib.com>

Visit our website to download manuals for Nikon imaging products, computer software, or firmware.

nikon download center B600



Nikon User Support

If you need any technical assistance with the operation of your Nikon product(s), please contact one of the Nikon representatives. For information on the Nikon representatives in your area, please visit <http://www.nikon-asia.com/support>.

Confirming the Package Contents

In the event that any items are missing, please contact the store where you purchased the camera.



- COOLPIX B600
Digital Camera



- Strap



- LC-CP29 Lens Cap
(with cord)



- EN-EL12 Rechargeable
Li-ion Battery



- EH-73P Charging AC
Adapter^{1,2}

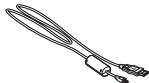

- UC-E21 USB Cable

- Quick Start Guide
(this manual)

- SnapBridge Connection
Guide

- Warranty
Guide

¹ A plug adapter is attached depending on the country or region of purchase. The shape of the plug adapter varies with the country or region of purchase (144).

² The EH-73PCH Charging AC Adapter may be included instead of the EH-73P, depending on the country or region where you purchased the camera.

NOTE: A memory card is not included with the camera. SD, SDHC, and SDXC memory cards are referred to as “memory cards” in this manual.

To View Images on a Computer or Smart Device

Use the following software or app.

Software for Computers

You can download software from our Download Center.

- ViewNX-i: This software enables you to transfer images and movies to your computer for viewing and editing.

App for Smart Devices

- SnapBridge: When you establish a wireless connection, this app enables you to upload images and movies to your smart device. See the included “SnapBridge Connection Guide” for information on how to download the app and establish a connection.

Information and Precautions

Life-Long Learning

As part of Nikon's "Life-Long Learning" commitment to ongoing product support and education, continually updated information is available online at the following websites:

- For users in the U.S.A.: <https://www.nikonusa.com/>
- For users in Europe: <https://www.europe-nikon.com/support/>
- For users in Asia, Oceania, the Middle East, and Africa: <http://www.nikon-asia.com/>

Visit these websites to keep up-to-date with the latest product information, tips, answers to frequently asked questions (FAQs), and general advice on digital imaging and photography. Additional information may be available from the Nikon representative in your area. Visit the website below for contact information.

<https://imaging.nikon.com/>

Use Only Nikon Brand Electronic Accessories

Nikon COOLPIX cameras are designed to the highest standards and include complex electronic circuitry. Only Nikon brand electronic accessories (including battery chargers, batteries, AC adapters, and USB cables) certified by Nikon specifically for use with this Nikon digital camera are engineered and proven to operate within the operational and safety requirements of this electronic circuitry.

THE USE OF NON-NIKON ELECTRONIC ACCESSORIES COULD DAMAGE THE CAMERA AND MAY VOID YOUR NIKON WARRANTY.

The use of third-party rechargeable Li-ion batteries not bearing the Nikon holographic seal could interfere with normal operation of the camera or result in the batteries overheating, igniting, rupturing, or leaking.

Holographic seal: Identifies this device as an authentic Nikon product.



For more information about Nikon brand accessories, contact a local authorized Nikon dealer.

Before Taking Important Pictures

Before taking pictures on important occasions (such as at weddings or before taking the camera on a trip), take a test shot to ensure that the camera is functioning normally. Nikon will not be held liable for damages or lost profits that may result from product malfunction.

About the Manuals

- No part of the manuals included with this product may be reproduced, transmitted, transcribed, stored in a retrieval system, or translated into any language in any form, by any means, without Nikon's prior written permission.
- Illustrations and screen content shown in this manual may differ from the actual product.
- Nikon reserves the right to change the specifications of the hardware and software described in these manuals at any time and without prior notice.
- Nikon will not be held liable for any damages resulting from the use of this product.
- While every effort was made to ensure that the information in these manuals is accurate and complete, we would appreciate it were you to bring any errors or omissions to the attention of the Nikon representative in your area (address provided separately).

Comply with Copyright Notices

Under copyright law, photographs or recordings of copyrighted works made with the camera can not be used without the permission of the copyright holder. Exceptions apply to personal use, but note that even personal use may be restricted in the case of photographs or recordings of exhibits or live performances.

Disposing of Data Storage Devices

Please note that deleting images or formatting data storage devices such as memory cards or built-in camera memory does not completely erase the original image data. Deleted files can sometimes be recovered from discarded storage devices using commercially available software, potentially resulting in the malicious use of personal image data. Ensuring the privacy of such data is the user's responsibility.

Before discarding a data storage device or transferring ownership to another person, make sure to reset all of the camera's settings in **Reset all** in the setup menu (📖14). After resetting, erase all data in the device using commercial deletion software, or format the device in **Format memory** or **Format card** in the setup menu (📖14), then completely refill it with images containing no private information (for example, images of empty sky). Care should be taken to avoid injury or damage to property when physically destroying memory cards.

Conformity Marking

Follow the procedure below to display some of the conformity markings that the camera complies with.

Press the **MENU** button → select **Y** (setup) → Conformity marking → **OK** button

For Your Safety

To prevent damage to property or injury to yourself or to others, read "For Your Safety" in its entirety before using this product.

Keep these safety instructions where all those who use this product will read them.



DANGER

Failure to observe the precautions marked with this icon carries a high risk of death or severe injury.



WARNING

Failure to observe the precautions marked with this icon could result in death or severe injury.



CAUTION

Failure to observe the precautions marked with this icon could result in injury or property damage.



WARNING

- **Do not use while walking or operating a vehicle.** Failure to observe this precaution could result in accidents or other injury.
- **Do not disassemble or modify this product. Do not touch internal parts that become exposed as the result of a fall or other accident.** Failure to observe these precautions could result in electric shock or other injury.
- **Should you notice any abnormalities such as the product producing smoke, heat, or unusual odors, immediately disconnect the battery or power source.** Continued operation could result in fire, burns or other injury.
- **Keep dry. Do not handle with wet hands. Do not handle the plug with wet hands.** Failure to observe these precautions could result in fire or electric shock.
- **Do not let your skin remain in prolonged contact with this product while it is on or plugged in.** Failure to observe this precaution could result in low-temperature burns.
- **Do not use this product in the presence of flammable dust or gas such as propane, gasoline or aerosols.** Failure to observe this precaution could result in explosion or fire.
- **Do not aim the flash at the operator of a motor vehicle.** Failure to observe this precaution could result in accidents.

- **Keep this product out of reach of children.** Failure to observe this precaution could result in injury or product malfunction. In addition, note that small parts constitute a choking hazard. Should a child swallow any part of this product, seek immediate medical attention.

- **Do not entangle, wrap or twist the straps around your neck.** Failure to observe this precaution could result in accidents.

- **Do not use batteries, chargers, AC adapters, or USB cables not specifically designated for use with this product. When using batteries, chargers, AC adapters, and USB cables designated for use with this product, do not:**
 - **Damage, modify, forcibly tug or bend the cords or cables, place them under heavy objects, or expose them to heat or flame.**
 - **Use travel converters or adapters designed to convert from one voltage to another or with DC-to-AC inverters.**

Failure to observe these precautions could result in fire or electric shock.

- **Do not handle the plug when charging the product or using the AC adapter during thunderstorms.** Failure to observe this precaution could result in electric shock.
- **Do not handle with bare hands in locations exposed to extremely high or low temperatures.** Failure to observe this precaution could result in burns or frostbite.



CAUTION

- **Do not leave the lens pointed at the sun or other strong light sources.** Light focused by the lens could cause fire or damage to product's internal parts. When shooting backlit subjects, keep the sun well out of the frame.
- **Turn this product off when its use is prohibited. Disable wireless features when the use of wireless equipment is prohibited.** The radio-frequency emissions produced by this product could interfere with equipment onboard aircraft or in hospitals or other medical facilities.
- **Remove the battery and disconnect the AC adapter if this product will not be used for an extended period.** Failure to observe this precaution could result in fire or product malfunction.
- **Do not touch moving parts of the lens or other moving parts.** Failure to observe this precaution could result in injury.
- **Do not fire the flash in contact with or in close proximity to the skin or objects.** Failure to observe this precaution could result in burns or fire.

- **Do not leave the product where it will be exposed to extremely high temperatures, for an extended period such as in an enclosed automobile or in direct sunlight.** Failure to observe this precaution could result in fire or product malfunction.
- **Do not transport the camera with a tripod or similar accessory attached.** Failure to observe this precaution could result in injury or product malfunction.



DANGER for Batteries

- **Do not mishandle batteries.** Failure to observe the following precautions could result in the batteries leaking, overheating, rupturing, or catching fire:
 - Use only rechargeable batteries approved for use in this product.
 - Do not expose batteries to flame or excessive heat.
 - Do not disassemble.
 - Do not short-circuit the terminals by touching them to necklaces, hairpins, or other metal objects.
 - Do not expose batteries or the products in which they are inserted to powerful physical shocks.
- **Charge only as indicated.** Failure to observe this precaution could result in the batteries leaking, overheating, rupturing, or catching fire.
- **If battery liquid comes into contact with the eyes, rinse with plenty of clean water and seek immediate medical attention.** Delaying action could result in eye injuries.



WARNING for Batteries



- **Keep batteries out of reach of children.** Should a child swallow a battery, seek immediate medical attention.
- **Do not immerse batteries in water or expose to rain.** Failure to observe this precaution could result in fire or product malfunction. Immediately dry the product with a towel or similar object should it become wet.
- **Discontinue use immediately should you notice any changes in the batteries, such as discoloration or deformation. Cease charging EN-EL12 rechargeable batteries if they do not charge in the specified period of time.** Failure to observe these precautions could result in the batteries leaking, overheating, rupturing, or catching fire.
- **When batteries are no longer needed, insulate the terminals with tape.** Overheating, rupture, or fire may result should metal objects come into contact with the terminals.

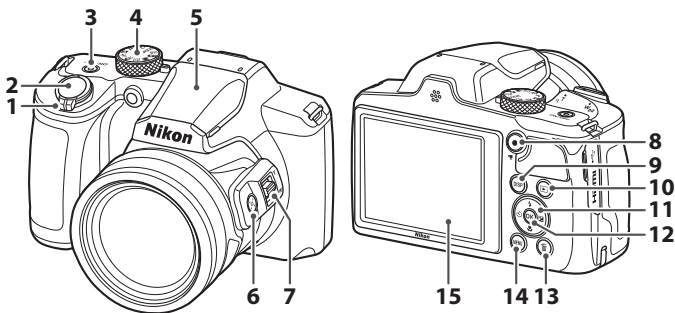

- **If battery liquid comes into contact with a person's skin or clothing, immediately rinse the affected area with plenty of clean water.** Failure to observe this precaution could result in skin irritation.
-

Parts of the Camera

The Camera Body



- 1 Zoom control
- 2 Shutter-release button
- 3 Power switch/power-on lamp (charge lamp)
- 4 Mode dial
- 5 Flash
- 6  (snap-back zoom) button
- 7 Side zoom control
- 8  movie-record) button

- 9 **DISP** (display) button
- 10  (playback) button
- 11 Multi selector*
- 12  (apply selection) button
- 13  (delete) button
- 14 **MENU** (menu) button
- 15 Monitor

* In this manual, pressing up, down, left, or right on the multi selector is expressed as ▲, ▼, ◀, or ▶.

Getting Started

How to Attach the Strap and Lens Cap

Attach the lens cap to the strap, and then attach the strap to the camera.

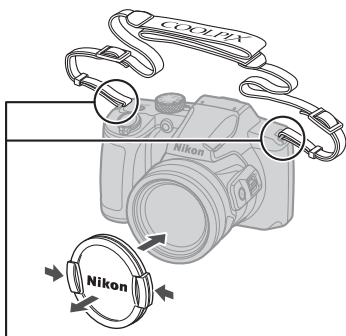
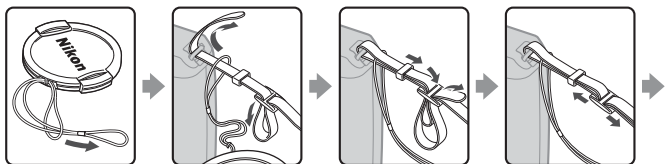

Attach the strap at two places.

✓ Lens Cap

When the camera is not in use, attach the lens cap to the lens to protect it.

Inserting the Battery and Memory Card

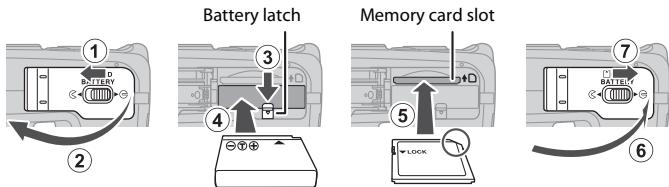

- With the battery's positive and negative terminals oriented correctly, move the orange battery latch (③), and fully insert the battery (④).
- Slide the memory card in until it clicks into place (⑤).
- Be careful not to insert the battery or memory card upside-down or backward, as this could cause a malfunction.
- If the write-protect switch of the memory card is locked, you cannot shoot, delete images, or format the memory card.
- Camera data, including images and movies, can be saved either on a memory card or in the internal memory. To use the internal memory, remove the memory card.

Formatting a Memory Card

The first time you insert a memory card that has been used in another device into this camera, make sure to format it with this camera.

- **Note that formatting a memory card permanently deletes all images and other data on the memory card.** Be sure to make copies of any images you wish to keep before formatting the memory card.
- Insert the memory card into the camera, press the **MENU** button, and select **Format card** in the setup menu (📖14).

Removing the Battery or Memory Card

Turn the camera off and make sure that the power-on lamp and screen have turned off, and then open the battery-chamber/memory card slot cover.

- Move the battery latch to eject the battery.
- Gently push the memory card into the camera to partially eject the memory card.
- Be careful when handling the camera, battery, and memory card immediately after using the camera, as they may be hot.
- During communication with a smart device through **Bluetooth** in the network menu (📖14) → **Send while off**, the power-on lamp turns on even though the camera is off.

Charging the Battery

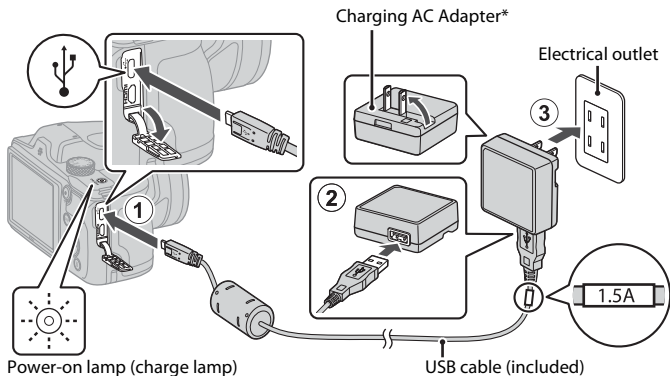

* A plug adapter is attached depending on the country or region of purchase. The shape of the plug adapter varies with the country or region of purchase.

- Charging starts when the camera is connected to an electrical outlet while the battery is inserted, as shown in the illustration. The power-on lamp (charge lamp) slowly flashes while the battery is charging.
- When charging is complete, the power-on lamp (charge lamp) turns off. Unplug the Charging AC Adapter from the electrical outlet, and disconnect the USB cable. Charging time is about 2 hours for a fully exhausted battery.
- The battery cannot be charged when the power-on lamp (charge lamp) quickly flashes, possibly due to one of the reasons described below.
 - The ambient temperature is not suited to charging.
 - The USB cable or Charging AC Adapter is not properly connected.
 - The battery is damaged.

✓ Notes About the USB Cable

- Do not use a USB cable other than the UC-E21. Using a USB cable other than the UC-E21 could result in overheating, fire, or electric shock.
- Check the shape and direction of the plugs and do not insert or remove the plugs at an angle.

✓ Notes About Charging the Battery

- The camera can be operated while the battery is charging, but the charging time increases. The power-on lamp (charge lamp) turns off while the camera is being operated.
- Do not, under any circumstances, use another make or model of AC adapter other than the EH-73P/EH-73PCH Charging AC Adapter, and do not use a commercially available USB-AC adapter or a battery charger for a mobile phone. Failure to observe this precaution could result in overheating or in damage to the camera.

Camera Setup

When the camera is turned on for the first time, screens to set the display language and camera clock are displayed.

1 Turn on the camera.

- Use the multi selector to select and adjust settings.

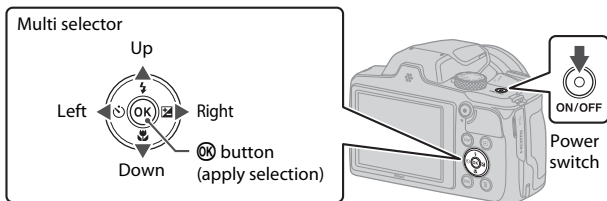

- A language selection screen will be displayed. Use the multi selector ▲▼ to highlight a language and press the OK button to select. The displayed languages vary depending on the country or region.

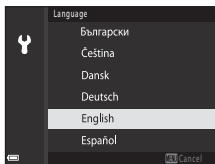

2 Select **Yes** and press the OK button.

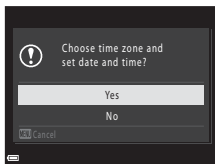

3 Highlight your home time zone and press the **OK** button.

- Press ▲ to set daylight saving time. When it is on, the time is one hour earlier and ☀️ is displayed. When you press ▼ to turn it off, the time goes back one hour.

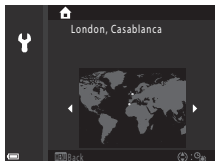

4 Press ▲▼ to select a date format and press the **OK** button.

5 Enter the current date and time for the camera clock and press the **OK** button.

- Press ◀▶ to highlight items and press ▲▼ to change.
- Select the minute field and press the **OK** button to confirm the setting.

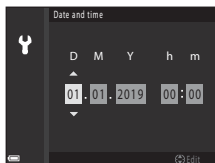

6 When prompted, select **Yes** and press the **OK** button.

- The camera switches to the shooting screen when setup is complete.

Setting the Language

The language can be set at any time in **Language** in the **Y** setup menu (📖14).

To Change the Time Zone and Date Setting

Set in **Time zone and date** in the **Y** setup menu.



In **Time zone**, the time is one hour earlier when daylight saving time is on, and goes back one hour when it is off.

Basic Shooting and Playback Operations

Shooting Images

 (auto) mode is used here as an example.  (auto) mode enables you to perform general shooting in a variety of shooting conditions.

1 Rotate the mode dial to .

- Battery level indicator
: The battery level is high.
: The battery level is low.
- Number of exposures remaining
 is displayed when no memory card is inserted in the camera, and images are saved in the internal memory.
- Press the **DISP** (display) button to switch the information displayed on the screen each time.

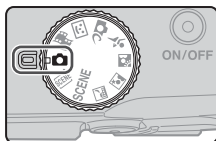

Battery level indicator

Number of exposures remaining

2 Hold the camera steady.

- Keep fingers and other objects away from the lens, flash, AF-assist illuminator, microphone, and speaker.

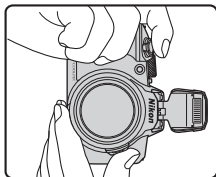
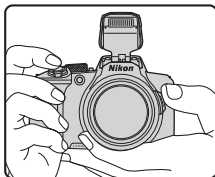

3 Frame the picture.

- Move the zoom control or the side zoom control to change the zoom lens position.
- If you lose sight of the subject while shooting with the lens in telephoto position, press the  (snap-back zoom) button to temporarily widen the visible area so that you can frame the subject more easily.

Zoom out

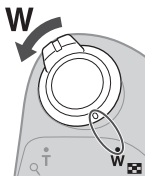

Zoom in

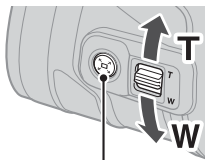

Zoom in

Zoom out

 button

4 Press the shutter-release button halfway.

- To press the shutter-release button “halfway” means to press and hold the button at the point where you feel a slight resistance.
- When the subject is in focus, the focus area or focus indicator is displayed in green.
- When you are using digital zoom, the camera focuses in the center of the frame and the focus area is not displayed.
- If the focus area or focus indicator flashes, the camera is unable to focus. Modify the composition and try pressing the shutter-release button halfway again.

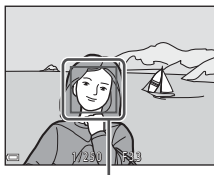
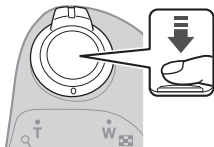

Focus area

5 Without lifting your finger, press the shutter-release button all the way down.



✓ Notes About Saving Images or Movies

The indicator showing the number of exposures remaining or the indicator showing the remaining recording time flashes, or **Please wait for the camera to finish recording**, is displayed while images or movies are being saved. **Do not open the battery-chamber/memory card slot cover or remove the battery or memory card** while an indicator is flashing. Doing this could result in loss of data, or in damage to the camera or the memory card.

📎 The Auto Off Function

- When no operations are performed for about one minute, the screen turns off, the camera enters standby mode, and then the power-on lamp flashes. The camera turns off after remaining in standby mode for about three minutes.
- To turn the screen back on while the camera is in standby mode, perform an operation such as pressing the power switch or shutter-release button.

📎 When Using a Tripod

- We recommend using a tripod to stabilize the camera in the following situations:
 - When the flash is lowered in dark locations or when using a shooting mode in which the flash does not fire
 - When the zoom is at a telephoto position
- When using a tripod to stabilize the camera during shooting, set **Photo VR** to **Off** in the setup menu (📖14) to prevent potential errors caused by this function.

Using the Flash

In situations where a flash is needed, such as in dark locations or when the subject is backlit, raise the flash with your hand.

- When the shooting screen is displayed, you can press the multi selector ▲ (⚡) to set the flash mode. To set the flash to always fire, select ⚡ (fill flash).
- When not using the flash, gently push to lower the flash.

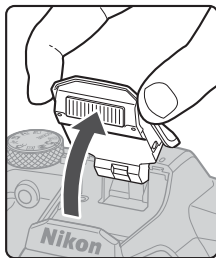



Recording Movies

Display the shooting screen and press the ● (🎥 movie-record) button to start recording a movie. Press the ● (🎥) button again to end recording.





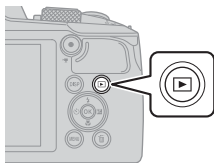

Playing Back Images

1 Press the  (playback) button to enter playback mode.

- If you press and hold down the  button while the camera is turned off, the camera turns on in playback mode.



2 Use the multi selector to select an image to display.

- Press and hold down    to scroll through the images quickly.
- Press the **DISP** (display) button to switch the information displayed on the screen each time.
- To play back a recorded movie, press the **OK** button.
- To return to shooting mode, press the  button or shutter-release button.
- When **OK: [effect icon]** is displayed in full-frame playback mode, you can press the **OK** button to apply an effect to the image.

Display the previous image



Display the next image



- Move the zoom control toward **T** () in full-frame playback mode to zoom in on an image.







- In full-frame playback mode, move the zoom control toward **W** () to switch to thumbnail playback mode and display multiple images on the screen.

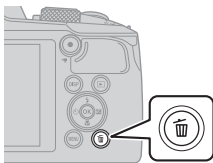

Deleting Images

- 1 In playback mode, press the  (delete) button to delete the image currently displayed on the screen.



- 2 Use the multi selector   to select the desired deletion method and press the  button.

- To exit without deleting, press the **MENU** button.

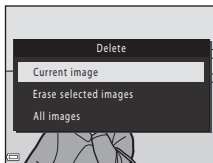

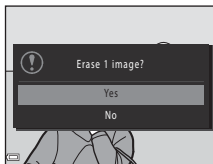

- 3 Select **Yes** and press the  button.

- Deleted images cannot be recovered.



Deleting Images Captured Continuously (Sequence)

- Images captured continuously, or with the multiple exp. lighten, creative mode, or self-collage function, are saved as a sequence, and only one image in the sequence (the key picture) is displayed in playback mode (default setting).
- If you press the  button while a key picture is displayed for a sequence of images, all images in the sequence are deleted.
- To delete individual images in a sequence, press the  button to display them one at a time and press the  button.



Deleting the Image Captured While in Shooting Mode

When using shooting mode, press the  button to delete the last image that was saved.

Other Functions

Selecting a Shooting Mode

You can rotate the mode dial to align the desired shooting mode with the indicator mark on the camera body.

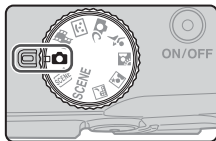





- **📷 (Auto) mode**

Select this mode to perform general shooting in a variety of shooting conditions.

- **SCENE, , , , ,  (Scene) modes**

Select any one of scene modes based on the shooting conditions, and you can take pictures with the appropriate settings for those conditions.

- **SCENE:** Press the **MENU** button and select a scene mode.
- ** (scene auto selector):** The camera recognizes the shooting conditions when you frame a picture, and you can take pictures in accordance with the conditions.
- ** (night landscape):** Use this mode to shoot night landscapes.
- ** (night portrait):** Use this mode to shoot evening and night portraits that include background scenery.
- ** (backlighting):** Use this mode to shoot backlit subjects.
- ** (sports):** Use this mode to shoot sports photos.



- ** (Creative) mode**

The camera saves four images with effects and one image without effects simultaneously in one shot.

- ** (Smart portrait) mode**

Use glamour retouch to enhance human faces during shooting, and use the smile timer or self-collage function to take pictures.

- ** (Short movie show) mode**

The camera creates a short movie that is up to 30 seconds long (** 1080/30p** or ** 1080/25p**) by recording and automatically combining multiple movie clips that are several seconds long.

Help Display

The descriptions of functions are displayed while changing the shooting mode or while the setting screen is displayed.

Press the shutter-release button halfway to quickly switch to shooting mode. You can show or hide the descriptions using **Help display** in **Monitor settings** in the setup menu (14).

Setting the Flash Mode, Self-timer, Macro Mode, and Exposure Compensation

When the shooting screen is displayed, you can press the multi selector ▲ (⚡) ◀ (⌚) ▼ (🌸) ▶ (📷) to set the functions described below.

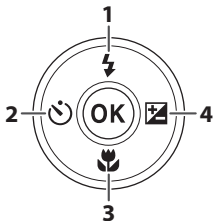



1	Flash mode When the flash is raised, the flash mode can be set according to shooting conditions. When ⚡ (fill flash) is selected, the flash always fires.
2	Self-timer The camera releases the shutter when the set number of seconds elapses after you press the shutter-release button.
3	Macro mode Use macro mode when you take close-up pictures.
4	<ul style="list-style-type: none">• Creative slider When the shooting mode is set to 📷 (auto) mode, you can adjust the brightness (exposure compensation), vividness, hue, and Active D-Lighting.• Exposure compensation When the shooting mode is set to modes other than 📷 (auto) mode, you can adjust the brightness (exposure compensation).

The functions that can be set vary depending on the shooting mode.

Menu Operations

You can press the **MENU** (menu) button to display the menu screen and change the camera's settings.

- The displayed menu varies depending on the status of the camera (during shooting or playback).
- Menu items are categorized by the icons on the left side of the screen.

When shooting	During playback
	
Menu categories	Menu categories
<ul style="list-style-type: none">• Shooting menu¹• Movie menu• Network menu• Setup menu	<ul style="list-style-type: none">• MODE Playback mode menu• Playback menu²• Network menu• Setup menu

¹ Icons vary depending on the shooting mode.

² Icons vary depending on the playback mode.

- 1** Press the **MENU** (menu) button to display the menu screen.

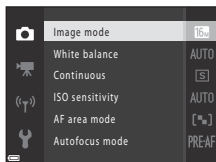

- 2** Press the multi selector to move to the menu category selection area.

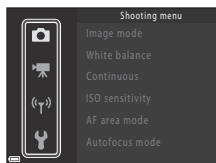

- 3** Press ▲▼ to change menu categories.

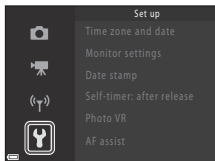

- 4** Press the **OK** button to confirm the menu category.

- Menu items corresponding to the selected menu category are displayed.

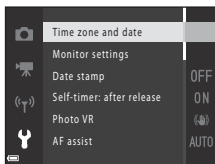

- 5** Press ▲▼ to select a menu option, and press the **OK** button to confirm the selection.

- Certain options cannot be selected depending on the current shooting mode or the state of the camera.

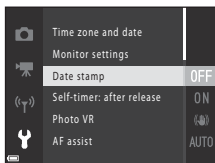

- 6** Press ▲▼ to select a setting, and press the **OK** button to confirm the selection.

- When you are finished using the menu, press the **MENU** button.
- When a menu is displayed, you can return to shooting mode by pressing the shutter-release button or **●** (▶ movie-record) button.

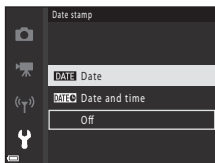

To Change the Flash Mode, Self-timer, Macro Mode, and Exposure Compensation Settings

When the shooting screen is displayed, you can press one of the multi selector ▲▼◀▶ to change settings such as the flash mode or self-timer (📖13).

If There Is a Problem

Troubleshooting

If the camera fails to function as expected, check the following before consulting your retailer or Nikon-authorized service representative.

- Turning off the camera once may solve the issue.
- If you cannot find a relevant entry, also check “If There Is a Problem” in the detailed “Reference Manual” (📖ii) or the Nikon website for your region.

Problem	Cause/Solution	📖
The camera is on but does not respond.	<ul style="list-style-type: none">• Wait for recording to end.• If the problem persists, turn the camera off. If the camera does not turn off, remove and reinsert the battery or batteries or, if you are using an AC adapter, disconnect and reconnect the AC adapter. Note that although any data currently being recorded will be lost, data that have already been recorded will not be affected by removing or disconnecting the power source.	–
The camera cannot be turned on.	The battery is exhausted.	3, 4, 23
The camera turns off without warning.	<ul style="list-style-type: none">• The camera automatically turns off to save power (auto off function).• The camera and battery may not work properly at low temperatures.• The inside of the camera or the battery has become hot. Leave the camera off until the inside of the camera has cooled, and then try turning it on again.	9 23 –
The monitor is blank.	<ul style="list-style-type: none">• The camera is off.• The battery is exhausted.• The camera automatically turns off to save power (auto off function).• The camera is connected to a TV or computer.• Multiple exp. Lighten scene mode shooting is in progress.	5 7 9 – –
The camera becomes hot.	The camera may become hot when used for an extended period of time such as to shoot movies, or when used in a hot environment; this is not a malfunction.	–

Technical Notes

Notices

Notices for Customers in the U.S.A.

IMPORTANT SAFETY INSTRUCTIONS - SAVE THESE INSTRUCTIONS.

DANGER - TO REDUCE THE RISK OF FIRE OR ELECTRIC SHOCK, CAREFULLY FOLLOW THESE INSTRUCTIONS

For connection to a supply not in the U.S.A., use an attachment plug adapter of the proper configuration for the power outlet if needed.

The power supply unit is intended to be correctly orientated in a vertical or floor mount position.

Federal Communications Commission (FCC) Radio Frequency Interference Statement

This equipment has been tested and found to comply with the limits for a Class B digital device, pursuant to Part 15 of the FCC rules. These limits are designed to provide reasonable protection against harmful interference

in a residential installation. This equipment generates, uses, and can radiate radio frequency energy and, if not installed and used in accordance with the instructions, may cause harmful interference to radio communications. However, there is no guarantee that interference will not occur in a particular installation. If this equipment does cause harmful interference to radio or television reception, which can be determined by turning the equipment off and on, the user is encouraged to try to correct the interference by one or more of the following measures:

- Reorient or relocate the receiving antenna.
- Increase the separation between the equipment and receiver.
- Connect the equipment into an outlet on a circuit different from that to which the receiver is connected.
- Consult the dealer or an experienced radio/television technician for help.



CAUTIONS

Modifications

The FCC requires the user to be notified that any changes or modifications made to this device that are not expressly approved by Nikon Corporation may void the user's authority to operate the equipment.

Interface Cables

Use the interface cables sold or provided by Nikon for your equipment. Using other interface cables may exceed the limits of Class B Part 15 of the FCC rules.

Nikon Inc.,

1300 Walt Whitman Road, Melville, New York 11747-3064, U.S.A.

Tel: 631-547-4200

Notice for Customers in Canada

CAN ICES-3 B / NMB-3 B

Notices for Customers in Europe

CAUTION: RISK OF EXPLOSION IF BATTERY IS REPLACED BY AN INCORRECT TYPE.

This symbol indicates that electrical and electronic equipment is to be collected separately.

The following apply only to users in European countries:

- This product is designated for separate collection at an appropriate collection point. Do not dispose of as household waste.
- Separate collection and recycling helps conserve natural resources and prevent negative consequences for human health and the environment that might result from incorrect disposal.
- For more information, contact the retailer or the local authorities in charge of waste management.



DISPOSE OF USED BATTERIES ACCORDING TO THE INSTRUCTIONS.

This symbol on the battery indicates that the battery is to be collected separately.

The following apply only to users in European countries:

- All batteries, whether marked with this symbol or not, are designated for separate collection at an appropriate collection point. Do not dispose of as household waste.
- For more information, contact the retailer or the local authorities in charge of waste management.



Notes About Wireless Communication Functions

Restrictions on Wireless Devices

The wireless transceiver included in this product conforms to wireless regulations in the country of sale and is not for use in other countries (products purchased in the EU or EFTA can be used anywhere within the EU and EFTA). Nikon does not accept liability for use in other countries. Users who are unsure as to the original country of sale should consult with their local Nikon service center or Nikon-authorized service representative. This restriction applies to wireless operation only and not to any other use of the product.

Security

Although one of the benefits of this product is that it allows others to freely connect for the wireless exchange of data anywhere within its range, the following may occur if security is not enabled:

- Data theft: Malicious third-parties may intercept wireless transmissions to steal user IDs, passwords, and other personal information.
- Unauthorized access: Unauthorized users may gain access to the network and alter data or perform other malicious actions. Note that due to the design of wireless networks, specialized attacks may allow unauthorized access even when security is enabled. Nikon is not responsible for data or information leaks that may occur during data transfer.
- Do not access networks that you are not permitted to use, even if they are displayed on your smartphone or tablet. Doing so may be regarded as unauthorized access. Only access networks that you are permitted to use.

Personal Information Management and Disclaimer

- User information registered and configured on the product, including wireless LAN connection settings and other personal information, is susceptible to alteration and loss resulting from operational error, static electricity, accident, malfunction, repair or other handling. Always keep separate copies of important information. Nikon is not responsible for any direct or indirect damages or lost profits resulting from alteration or loss of content that is not attributable to Nikon.
- Before discarding this product or transferring it to another owner, perform **Reset all** in the setup menu (📖14) to delete all user information registered and configured with the product, including wireless LAN connection settings and other personal information.
- Nikon is not responsible for any damages resulting from unauthorized use of this product by third parties in the event that the product is stolen or lost.

Precautions when Exporting or Carrying This Product Abroad

This product is controlled by the United States Export Administration Regulations (EAR). The permission of the United States government is not required for export to countries other than the following, which as of this writing are subject to embargo or special controls: Cuba, Iran, North Korea, Sudan, and Syria (list subject to change).

Notice for Customers in the U.S.A. and Canada

Federal Communications Commission (FCC) and Innovation, Science and Economic Development Canada (ISED)

Declaration of Conformity

This device complies with part 15 of FCC Rules and Innovation, Science and Economic Development Canada's licence-exempt RSSs. Operation is subject to the following two conditions: (1) this device may not cause harmful interference, and (2) this device must accept any interference received, including interference that may cause undesired operation.

FCC/ISED RF Exposure Statement

This transmitter must not be co-located or operated in conjunction with any other antenna or transmitter.

The available scientific evidence does not show that any health problems are associated with using low power wireless devices. There is no proof, however, that these low power wireless devices are absolutely safe. Low power Wireless devices emit low levels of radio frequency energy (RF) in the microwave range while being used. Whereas high levels of RF can produce health effects (by heating tissue), exposure of low-level RF that does not produce heating effects causes no known adverse health effects. Many studies of low-level RF exposures have not found any biological effects. Some studies have suggested that some biological effects might occur, but such findings have not been confirmed by additional research.

This product has been tested and found to comply with FCC/ISED radiation exposure limits set forth for an uncontrolled environment and meets the FCC radio frequency (RF) Exposure Guidelines and RSS-102 of the ISED radio frequency (RF) Exposure rules. Please refer to the SAR test report that was uploaded to FCC website.

Notice for Customers in Singapore

This device complies with radio-frequency regulations.

**Complies with
IMDA Standards
DA103423**

Notice for Customers in Nigeria

This device complies with radio-frequency regulations.

Connection and use of this communications
equipment is permitted by the Nigerian
Communications Commission

Caring for the Product

Observe the precautions described below in addition to the warnings in “For Your Safety” (📖vii–x) when using or storing the device.

The Camera

Do Not Apply Strong Impact to the Camera

The product may malfunction if subjected to strong shock or vibration. In addition, do not touch or apply force to the lens.

Keep Dry

The device will be damaged if immersed in water or subjected to high humidity.

Avoid Sudden Changes in Temperature

Sudden changes in temperature, such as when entering or leaving a heated building on a cold day, can cause condensation to form inside the device. To prevent condensation, place the device in a carrying case or a plastic bag before exposing it to sudden changes in temperature.

Keep Away from Strong Magnetic Fields

Do not use or store this device in the vicinity of equipment that generates strong electromagnetic radiation or magnetic fields. Doing so could result in loss of data or camera malfunction.

Do Not Point the Lens at Strong Light Sources for Extended Periods

Avoid pointing the lens at the sun or other strong light sources for extended periods when using or storing the camera. Intense light may cause the image sensor to deteriorate or produce a white blur effect in photographs.

Turn the Product Off Before Removing or Disconnecting the Power Source or Memory Card

Do not remove the battery while the product is on, or while images are being saved or deleted. Forcibly cutting power in these circumstances could result in loss of data or in damage to the memory card or internal circuitry.

Notes About the Monitor

- Monitors (including electronic viewfinders) are constructed with extremely high precision; at least 99.99% of pixels are effective, with no more than 0.01% being missing or defective. Hence while these displays may contain pixels that are always lit (white, red, blue, or green) or always off (black), this is not a malfunction and has no effect on images recorded with the device.
- Images in the monitor may be difficult to see under bright lighting.
- Do not apply pressure to the monitor, as this could cause damage or malfunction. Should the monitor break, care should be taken to avoid injury caused by broken glass and to prevent the liquid crystal from the display touching the skin or entering the eyes or mouth.

The Battery

Precautions for Use

- Note that the battery may become hot after use.
- Do not use the battery at ambient temperatures below 0°C (32°F) or above 40°C (104°F) as this could cause damage or malfunction.
- If you notice any abnormalities such as excessive heat, smoke, or an unusual smell coming from the battery, immediately discontinue use and consult your retailer or Nikon-authorized service representative.
- After removing the battery from the camera or optional battery charger, put the battery in a plastic bag, etc. in order to insulate it.

Charging the Battery

Check the battery level before using the camera and replace or charge the battery if necessary.

- Charge the battery indoors with an ambient temperature of 5°C to 35°C (41°F to 95°F) before use.
- A high battery temperature may prevent the battery from charging properly or completely, and may reduce battery performance. Note that the battery may become hot after use; wait for the battery to cool before charging. When charging the battery inserted into this camera using the Charging AC Adapter or a computer, the battery is not charged at battery temperatures below 0°C (32°F) or above 50°C (122°F).
- Do not continue charging once the battery is fully charged as this will result in reduced battery performance.
- The battery temperature may increase during charging. However, this is not a malfunction.

Carrying Spare Batteries

Whenever possible, carry fully charged spare batteries when taking pictures on important occasions.

Using the Battery When Cold

On cold days, the capacity of batteries tends to decrease. If an exhausted battery is used at a low temperature, the camera may not turn on. Keep spare batteries in a warm place and exchange as necessary. Once warmed, a cold battery may recover some of its charge.

Battery Terminals

Dirt on the battery terminals may prevent the camera from functioning. Should the battery terminals become dirty, wipe them off with a clean, dry cloth before use.

Charging an Exhausted Battery

Turning the camera on or off while an exhausted battery is inserted in the camera may result in reduced battery life. Charge the exhausted battery before use.

Storing the Battery

- Always remove the battery from the camera or optional battery charger when it is not being used. Minute amounts of current are drawn from the battery while it is in the camera, even when not in use. This may result in excessive battery drain and complete loss of function.
- Charging a used battery within six months is recommended. When storing the battery for long periods, recharge it at least once every six months and use the camera until the battery level indicator is  before returning it to storage.
- Put the battery in a plastic bag, etc. in order to insulate it and store it in a cool place. The battery should be stored in a dry location with an ambient temperature of 15°C to 25°C (59°F to 77°F). Do not store the battery in hot or extremely cold locations.

Battery Life

A marked drop in the time a fully charged battery retains its charge, when used at room temperature, indicates that the battery needs to be replaced. Purchase a new battery.

Recycling Used Batteries

Recycle rechargeable batteries in accord with local regulations, being sure to first insulate the terminals with tape.

The Charging AC Adapter

- The EH-73P/EH-73PCH Charging AC Adapter is for use only with compatible devices. Do not use with another make or model of device.
- Do not use any USB cable other than the UC-E21. Using a USB cable other than the UC-E21 could result in overheating, fire or electric shock.
- Do not, under any circumstances, use another make or model of AC adapter other than the EH-73P/EH-73PCH Charging AC Adapter, and do not use a commercially available USB-AC adapter or a battery charger for a mobile phone. Failure to observe this precaution could result in overheating or in damage to the camera.
- The EH-73P/EH-73PCH is compatible with AC 100–240 V, 50/60 Hz electrical outlets. When using in other countries, use a plug adapter (commercially available) as necessary. For more information about plug adapters, consult your travel agency.
- The symbols on this product represent the following:
~ AC, = DC,  Class II equipment (The construction of the product is double-insulated.)

Cleaning and Storage

Cleaning

Do not use alcohol, thinner, or other volatile chemicals.

Lens	Avoid touching glass parts with your fingers. Remove dust or lint with a blower (typically a small device with a rubber bulb attached to one end that is pumped to produce a stream of air out the other end). To remove fingerprints or other stains that cannot be removed with a blower, wipe the lens with a soft cloth, using a spiral motion that starts at the center of the lens and working toward the edges. If this fails, clean the lens using a cloth lightly dampened with commercial lens cleaner.
Monitor	Remove dust or lint with a blower. To remove fingerprints and other stains, clean the monitor with a soft, dry cloth, being careful not to apply pressure.
Body	Use a blower to remove dust, dirt, or sand, then wipe gently with a soft, dry cloth. After using the camera at the beach or other sandy or dusty environment, wipe off any sand, dust, or salt with a dry cloth lightly dampened with fresh water and dry thoroughly. Note that foreign matter inside the camera could cause damage not covered by the warranty.

Storage

Remove the battery if the camera will not be used for an extended period. To prevent mold or mildew, take the camera out of storage at least once a month.

Turn the camera on and release the shutter a few times before putting the camera away again. Do not store the camera in any of the following locations:

- Places that are poorly ventilated or subject to humidity of over 60%
- Exposed to temperatures above 50°C (122°F) or below -10°C (14°F)
- Next to equipment that produces strong electromagnetic fields, such as televisions or radios

For storing the battery, follow the precautions in “The Battery” (📖23) in “Caring for the Product” (📖22).

Memory Cards That Can Be Used

The camera supports SD, SDHC, and SDXC memory cards.

- Memory cards with an SD Speed Class rating of 6 (Video Speed Class V6) or faster are recommended for recording movies. When using a memory card with a lower Speed Class rating, movie recording may stop unexpectedly.
- If you use a card reader, make sure that it is compatible with your memory card.
- Contact the manufacturer for information on features, operation, and limitations on use.

Trademark Information

- Windows is either a registered trademark or trademark of Microsoft Corporation in the United States and/or other countries.
- The *Bluetooth*® word mark and logos are registered trademarks owned by Bluetooth SIG, Inc. and any use of such marks by Nikon Corporation is under license.
- Apple®, App Store®, the Apple logos, Mac, OS X, macOS, iPhone®, iPad®, iPod touch® and iBooks are trademarks or registered trademarks of Apple Inc., in the U.S. and other countries.
- Android, Google Play and the Google Play logo are trademarks of Google LLC. The Android robot is reproduced or modified from work created and shared by Google and used according to terms described in the Creative Commons 3.0 Attribution License.
- iOS is a trademark or registered trademark of Cisco Systems, Inc., in the United States and/or other countries and is used under license.
- Adobe, the Adobe logo, Acrobat, and Reader are either trademarks or registered trademarks of Adobe Systems Incorporated in the United States and/or other countries.
- SDXC, SDHC, and SD Logos are trademarks of SD-3C, LLC.



- PictBridge is a trademark.
- HDMI, HDMI logo and High-Definition Multimedia Interface are trademarks or registered trademarks of HDMI Licensing, LLC.

HDMI

- Wi-Fi and the Wi-Fi logo are trademarks or registered trademarks of the Wi-Fi Alliance.
- All other trade names mentioned in this manual or the other documentation provided with your Nikon product are the trademarks or registered trademarks of their respective holders.

Use of the Made for Apple badge means that an accessory has been designed to connect specifically to the Apple products identified in the badge, and has been certified by the developer to meet Apple performance standards. Apple is not responsible for the operation of this device or its compliance with safety and regulatory standards. Please note that the use of this accessory with an Apple product may affect wireless performance.

AVC Patent Portfolio License

This product is licensed under the AVC Patent Portfolio License for the personal and non-commercial use of a consumer to (i) encode video in compliance with the AVC standard ("AVC video") and/or (ii) decode AVC video that was encoded by a consumer engaged in a personal and non-commercial activity and/or was obtained from a video provider licensed to provide AVC video. No license is granted or shall be implied for any other use.

Additional information may be obtained from MPEG LA, L.L.C.

See <http://www.mpegla.com>.

FreeType License (FreeType2)

Portions of this software are copyright © 2012 The FreeType Project (<https://www.freetype.org>). All rights reserved.

MIT License (HarfBuzz)

Portions of this software are copyright © 2019 The HarfBuzz Project (<https://www.freedesktop.org/wiki/Software/HarfBuzz>). All rights reserved.



A series of horizontal dashed lines spanning the width of the page, intended for handwriting practice.



A series of horizontal dashed lines spanning the width of the page, intended for handwriting practice.

No reproduction in any form of this manual, in whole or in part (except for brief quotation in critical articles or reviews), may be made without written authorization from NIKON CORPORATION.

Please visit the Nikon website below to download the Reference Manual in English.

संदर्भ मैनुअल को हिंदी में डाउनलोड करने के लिए नीचे दी गई Nikon वेबसाइट पर जाएँ।

<https://downloadcenter.nikonimglib.com>

NIKON CORPORATION

© 2019 Nikon Corporation



CT9F04(11)
6MQ02611-04