

Nikon

DIGITAL CAMERA

D5300

User's Manual

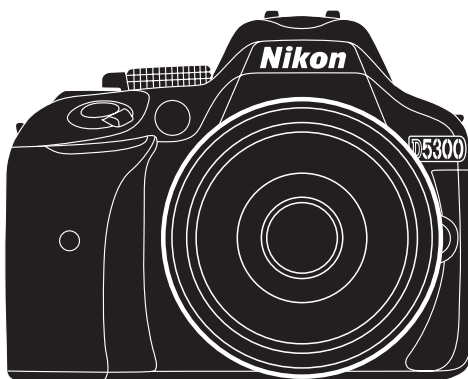

Nikon Manual Viewer 2
Use the Nikon Manual Viewer 2 app to view manuals anytime, anywhere on your smartphone or tablet.

En

Product Documentation

Symbols and Conventions

To make it easier to find the information you need, the following symbols and conventions are used:



This icon marks cautions; information that should be read before use to prevent damage to the camera.



This icon marks notes; information that should be read before using the camera.



This icon marks references to other pages in this manual.

Menu items, options, and messages displayed in the camera monitor are shown in **bold**.

Camera Settings

The explanations in this manual assume that default settings are used.

Nikon Manual Viewer 2



Install the Nikon Manual Viewer 2 app on your smartphone or tablet to view Nikon digital camera manuals, anytime, anywhere. Nikon Manual Viewer 2 can be downloaded free of charge from the App Store and Google Play. Download of the app and any product manuals requires an Internet connection, for which fees may be levied by your phone or Internet service provider.

For Your Safety

Before using the camera for the first time, read the safety instructions in “For Your Safety” (📖 vi–xii).

The Reference Manual

For more information on using your Nikon camera, download a pdf copy of the camera *Reference Manual* from the website listed below. The *Reference Manual* can be viewed using Adobe Reader or Adobe Acrobat Reader 5.0 or later.

- 1 On your computer, launch a web browser and open the Nikon manual download site at <http://downloadcenter.nikonimglib.com/>
- 2 Navigate to the page for the desired product and download the manual.

Package Contents

Confirm that the package contains the following items:

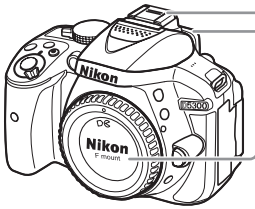

D5300 camera



BS-1 accessory shoe cover



DK-25 rubber eyecup



BF-1B body cap

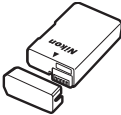

EN-EL14a rechargeable Li-ion battery (with terminal cover)



MH-24 battery charger (plug adapter supplied in countries or regions where required; shape depends on country of sale)



AN-DC3 strap

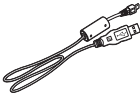

UC-E17 USB cable



EG-CP16 audio/video cable



DK-5 eyepiece cap

ViewNX 2 CD-ROM

Warranty

User's Manual (this booklet)

Purchasers of the lens kit option should confirm that the package also includes a lens. Memory cards are sold separately (□ 66). Cameras purchased in Japan display menus and messages in English and Japanese only; other languages are not supported. We apologize for any inconvenience this may cause.

Quick Start Guide

Follow these steps for a quick start with the D5300.

1 Attach the camera strap (☞ 9).

Attach the strap as shown. Repeat for the second eyelet.

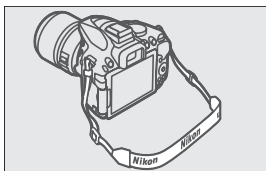

2 Charge the battery (☞ 9).

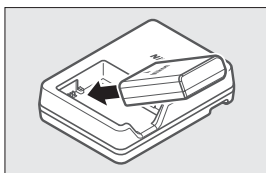

3 Insert the battery and memory card (☞ 10).

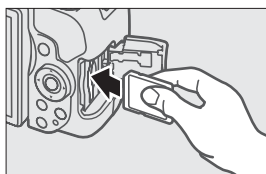
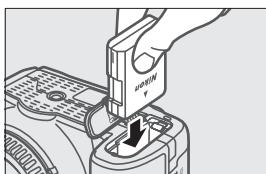

4 Attach a lens (☞ 11).

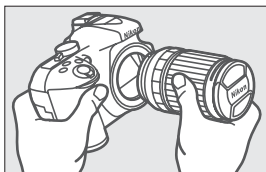

5 Open the monitor (☞ 6, 12).

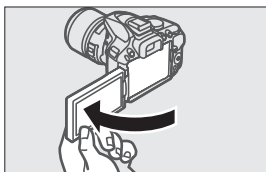

6 Turn the camera on (📖 12).

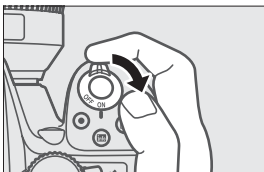

7 Choose a language and set the camera clock (📖 13).

8 Frame the photograph (📖 18).

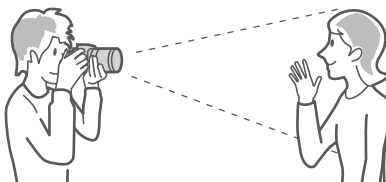

9 Press the shutter-release button halfway (📖 19).

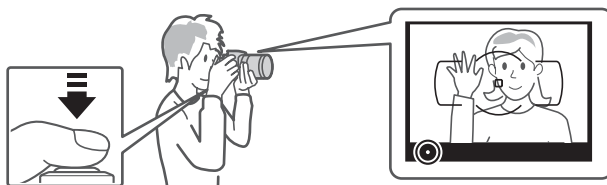

10 Shoot (📖 19).

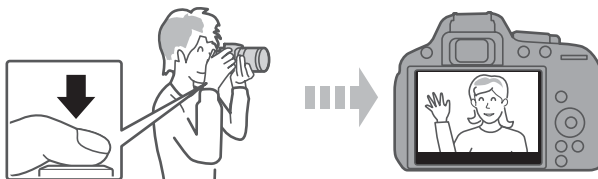



























Table of Contents

Package Contents.....	i
Quick Start Guide.....	ii
For Your Safety	vi
Notices.....	ix
Location Data.....	xiii
Wireless	xiv
Introduction	1
Getting to Know the Camera.....	1
First Steps	9
“Point-and-Shoot” Modes (AUTO and )	17
Framing Photos in the Viewfinder.....	18
Viewing Photographs	20
Deleting Unwanted Pictures	21
Framing Photos in the Monitor	22
Viewing Photographs	25
Deleting Unwanted Pictures	25
Recording Movies.....	26
Viewing Movies	29
Deleting Unwanted Movies	30
Matching Settings to the Subject or Situation (Scene Mode)	31
The Mode Dial.....	32
 Portrait	32
 Landscape.....	32
 Child	32
 Sports	32
 Close up.....	32
Other Scenes	33
 Night Portrait.....	33
 Night Landscape	33
 Party/Indoor	33
 Beach/Snow	33
 Sunset	33
 Dusk/Dawn.....	33
 Pet Portrait	33
 Candlelight	33
 Blossom	34
 Autumn Colors.....	34
 Food.....	34

Special Effects **35**

 Night Vision	35
 Color Sketch	35
 Toy Camera Effect	35
 Miniature Effect	36
 Selective Color	36
 Silhouette	36
 High Key	36
 Low Key	36
 HDR Painting	36
Options Available in Live View	37

P, S, A, and M Modes **41**

Mode P (Programmed Auto)	42
Mode S (Shutter-Priority Auto)	42
Mode A (Aperture-Priority Auto)	42
Mode M (Manual)	42
Exposure Compensation	44

Location Data **45**

Embedding Location Data in Photos and Movies	45
--	----

Wi-Fi **48**

What Wi-Fi Can Do for You	48
Accessing the Camera	49

Camera Menus **54**

Menu Options	55
--------------------	----

ViewNX 2 **59**

Installing ViewNX 2	59
Using ViewNX 2	61
Copy Pictures to the Computer	61
View Pictures	62

Technical Notes **63**

Compatible Lenses	63
Other Accessories	64
Approved Memory Cards	66
Caring for the Camera	67
Caring for the Camera and Battery: Cautions	68
Error Messages	71
Specifications	74

For Your Safety

To prevent damage to your Nikon product or injury to yourself or to others, read the following safety precautions in their entirety before using this equipment. Keep these safety instructions where all those who use the product will read them.

The consequences that could result from failure to observe the precautions listed in this section are indicated by the following symbol:



This icon marks warnings. To prevent possible injury, read all warnings before using this Nikon product.

■ ■ WARNINGS

Keep the sun out of the frame

Keep the sun well out of the frame when shooting backlit subjects. Sunlight focused into the camera when the sun is in or close to the frame could cause a fire.

Do not look at the sun through the viewfinder

Viewing the sun or other strong light source through the viewfinder could cause permanent visual impairment.

Using the viewfinder diopter adjustment control

When operating the viewfinder diopter adjustment control with your eye to the viewfinder, care should be taken not to put your finger in your eye accidentally.

Turn off immediately in the event of malfunction

Should you notice smoke or an unusual smell coming from the equipment or AC adapter (available separately), unplug the AC adapter and remove the battery immediately, taking care to avoid burns. Continued operation could result in injury. After removing the battery, take the equipment to a Nikon-authorized service center for inspection.

Do not use in the presence of flammable gas

Do not use electronic equipment in the presence of flammable gas, as this could result in explosion or fire.

Keep out of reach of children

Failure to observe this precaution could result in injury. In addition, note that small parts constitute a choking hazard. Should a child swallow any part of this equipment, consult a physician immediately.

Do not disassemble

Touching the product's internal parts could result in injury. In the event of malfunction, the product should be repaired only by a qualified technician. Should the product break open as the result of a fall or other accident, remove the battery and/or AC adapter and then take the product to a Nikon-authorized service center for inspection.

Do not place the strap around the neck of an infant or child

Placing the camera strap around the neck of an infant or child could result in strangulation.

Do not remain in contact with the camera, battery, or charger for extended periods while the devices are on or in use

Parts of the device become hot. Leaving the device in direct contact with the skin for extended periods may result in low-temperature burns.

- ⚠ **Do not leave the product where it will be exposed to extremely high temperatures, such as in an enclosed automobile or in direct sunlight**
Failure to observe this precaution could cause damage or fire.
- ⚠ **Do not aim a flash at the operator of a motor vehicle**
Failure to observe this precaution could result in accidents.
- ⚠ **Observe caution when using the flash**
 - Using the camera with the flash in close contact with the skin or other objects could cause burns.
 - Using the flash close to the subject's eyes could cause temporary visual impairment. The flash should be no less than one meter (3 ft 4 in.) from the subject. Particular care should be observed when photographing infants.
- ⚠ **Avoid contact with liquid crystal**
Should the monitor break, care should be taken to avoid injury due to broken glass and to prevent the liquid crystal from the monitor touching the skin or entering the eyes or mouth.
- ⚠ **Do not carry tripods with a lens or camera attached**
You could trip or accidentally strike others, resulting in injury.
- ⚠ **Observe proper precautions when handling batteries**
Batteries may leak, overheat, rupture, or catch fire if improperly handled. Observe the following precautions when handling batteries for use in this product:
 - Use only batteries approved for use in this equipment.
 - Do not short or disassemble the battery.
 - Do not expose the battery or the camera in which it is inserted to powerful physical shocks.
 - Be sure the product is off before replacing the battery. If you are using an AC adapter, be sure it is unplugged.
 - Do not attempt to insert the battery upside down or backwards.
- Do not expose the battery to flame or to excessive heat.
- Do not immerse in or expose to water.
- Replace the terminal cover when transporting the battery. Do not transport or store the battery with metal objects such as necklaces or hairpins.
- Batteries are prone to leakage when fully discharged. To avoid damage to the product, be sure to remove the battery when no charge remains.
- When the battery is not in use, attach the terminal cover and store in a cool, dry place.
- The battery may be hot immediately after use or when the product has been used on battery power for an extended period. Before removing the battery turn the camera off and allow the battery to cool.
- Discontinue use immediately should you notice any changes in the battery, such as discoloration or deformation.

 **Observe proper precautions when handling the charger**

- Keep dry. Failure to observe this precaution could result in fire or electric shock.
- Do not short the charger terminals. Failure to observe this precaution could result in overheating and damage to the charger.
- Dust on or near the metal parts of the plug should be removed with a dry cloth. Continued use could result in fire.
- Do not go near the charger during thunderstorms. Failure to observe this precaution could result in electric shock.
- Do not handle the plug or charger with wet hands. Failure to observe this precaution could result in electric shock.
- Do not use with travel converters or adapters designed to convert from one voltage to another or with DC-to-AC inverters. Failure to observe this precaution could damage the product or cause overheating or fire.

 **Use appropriate cables**

When connecting cables to the input and output jacks, use only the cables provided or sold by Nikon for the purpose to maintain compliance with product regulations.

 **CD-ROMs**

CD-ROMs containing software or manuals should not be played back on audio CD equipment. Playing CD-ROMs on an audio CD player could cause hearing loss or damage the equipment.

 **Follow the directions of airline and hospital personnel**

Remove Eye-Fi cards, disable Wi-Fi, and select **Off** for **Location data** > **Record location data** before boarding an aircraft, and turn the product off during takeoff and landing or when so directed by airline or hospital staff. Radio waves emitted by the device could interfere with aircraft navigation or hospital medical equipment.

Notices

- No part of the manuals included with this product may be reproduced, transmitted, transcribed, stored in a retrieval system, or translated into any language in any form, by any means, without Nikon's prior written permission.
- Nikon reserves the right to change the appearance and specifications of the hardware and software described in these manuals at any time and without prior notice.
- Nikon will not be held liable for any damages resulting from the use of this product.
- While every effort has been made to ensure that the information in these manuals is accurate and complete, we would appreciate it were you to bring any errors or omissions to the attention of the Nikon representative in your area (address provided separately).

Notice for Customers in Canada

CAN ICES-3 B / NMB-3 B

Notices for Customers in Europe

CAUTION

RISK OF EXPLOSION IF BATTERY IS REPLACED BY AN INCORRECT TYPE. DISPOSE OF USED BATTERIES ACCORDING TO THE INSTRUCTIONS.

This symbol indicates that electrical and electronic equipment is to be collected separately.



The following apply only to users in European countries:

- This product is designated for separate collection at an appropriate collection point. Do not dispose of as household waste.
- Separate collection and recycling helps conserve natural resources and prevent negative consequences for human health and the environment that might result from incorrect disposal.
- For more information, contact the retailer or the local authorities in charge of waste management.

This symbol on the battery indicates that the battery is to be collected separately.



The following apply only to users in European countries:

- All batteries, whether marked with this symbol or not, are designated for separate collection at an appropriate collection point. Do not dispose of as household waste.
- For more information, contact the retailer or the local authorities in charge of waste management.

Notices for Customers in the U.S.A.

The Battery Charger

**IMPORTANT SAFETY INSTRUCTIONS—SAVE THESE INSTRUCTIONS
DANGER—TO REDUCE THE RISK OF FIRE OR ELECTRIC SHOCK, CAREFULLY
FOLLOW THESE INSTRUCTIONS**

For connection to a supply not in the U.S.A., use an attachment plug adapter of the proper configuration for the power outlet if needed. This power unit is intended to be correctly oriented in a vertical or floor mount position.

Federal Communications Commission (FCC) Radio Frequency Interference Statement

This equipment has been tested and found to comply with the limits for a Class B digital device, pursuant to Part 15 of the FCC rules. These limits are designed to provide reasonable protection against harmful interference in a residential installation. This equipment generates, uses, and can radiate radio frequency energy and, if not installed and used in accordance with the instructions, may cause harmful interference to radio communications. However, there is no guarantee that interference will not occur in a particular installation. If this equipment does cause harmful interference to radio or television reception, which can be determined by turning the equipment off and on, the user is encouraged to try to correct the interference by one or more of the following measures:

- Reorient or relocate the receiving antenna.
- Increase the separation between the equipment and receiver.
- Connect the equipment into an outlet on a circuit different from that to which the receiver is connected.
- Consult the dealer or an experienced radio/television technician for help.



Nikon
D5300

CAUTIONS

Modifications

The FCC requires the user to be notified that any changes or modifications made to this device that are not expressly approved by Nikon Corporation may void the user's authority to operate the equipment.

Interface Cables

Use the interface cables sold or provided by Nikon for your equipment. Using other interface cables may exceed the limits of Class B Part 15 of the FCC rules.

Nikon Inc., 1300 Walt Whitman Road,
Melville, New York 11747-3064, U.S.A.
Tel.: 631-547-4200

Notice Concerning Prohibition of Copying or Reproduction

Note that simply being in possession of material that has been digitally copied or reproduced by means of a scanner, digital camera, or other device may be punishable by law.

- **Items prohibited by law from being copied or reproduced**

Do not copy or reproduce paper money, coins, securities, government bonds, or local government bonds, even if such copies or reproductions are stamped "Sample."

The copying or reproduction of paper money, coins, or securities which are circulated in a foreign country is prohibited.

Unless the prior permission of the government has been obtained, the copying or reproduction of unused postage stamps or post cards issued by the government is prohibited.

The copying or reproduction of stamps issued by the government and of certified documents stipulated by law is prohibited.

- **Cautions on certain copies and reproductions**

The government has issued cautions on copies or reproductions of securities issued by private companies (shares, bills, checks, gift certificates, etc.), commuter passes, or coupon tickets, except when a minimum of necessary copies are to be provided for business use by a company. Also, do not copy or reproduce passports issued by the government, licenses issued by public agencies and private groups, ID cards, and tickets, such as passes and meal coupons.

- **Comply with copyright notices**

The copying or reproduction of copyrighted creative works such as books, music, paintings, woodcuts, prints, maps, drawings, movies, and photographs is governed by national and international copyright laws. Do not use this product for the purpose of making illegal copies or to infringe copyright laws.

Disposing of Data Storage Devices

Please note that deleting images or formatting memory cards or other data storage devices does not completely erase the original image data. Deleted files can sometimes be recovered from discarded storage devices using commercially available software, potentially resulting in the malicious use of personal image data. Ensuring the privacy of such data is the user's responsibility.

Before discarding a data storage device or transferring ownership to another person, select **Off** for **Location data > Record location data** (□ 46) in the setup menu and, erase all data using commercial deletion software, or format the device and then completely refill it with images containing no private information (for example, pictures of empty sky). Be sure to also replace any pictures selected for preset manual. To delete track log data on a memory card, select **Location data > Log list** and delete all logs. Wi-Fi settings can be reset to default values by selecting **Wi-Fi > Network settings > Reset network settings** in the setup menu. Care should be taken to avoid injury when physically destroying data storage devices.

AVC Patent Portfolio License

THIS PRODUCT IS LICENSED UNDER THE AVC PATENT PORTFOLIO LICENSE FOR THE PERSONAL AND NON-COMMERCIAL USE OF A CONSUMER TO (i) ENCODE VIDEO IN COMPLIANCE WITH THE AVC STANDARD ("AVC VIDEO") AND/OR (ii) DECODE AVC VIDEO THAT WAS ENCODED BY A CONSUMER ENGAGED IN A PERSONAL AND NON-COMMERCIAL ACTIVITY AND/OR WAS OBTAINED FROM A VIDEO PROVIDER LICENSED TO PROVIDE AVC VIDEO. NO LICENSE IS GRANTED OR SHALL BE IMPLIED FOR ANY OTHER USE. ADDITIONAL INFORMATION MAY BE OBTAINED FROM MPEG LA, L.L.C. SEE <http://www.mpegla.com>

Use Only Nikon Brand Electronic Accessories

Nikon cameras are designed to the highest standards and include complex electronic circuitry. Only Nikon brand electronic accessories (including chargers, batteries, AC adapters, and flash accessories) certified by Nikon specifically for use with this Nikon digital camera are engineered and proven to operate within the operational and safety requirements of this electronic circuitry.

The use of non-Nikon electronic accessories could damage the camera and may void your Nikon warranty. The use of third-party rechargeable Li-ion batteries not bearing the Nikon holographic seal shown at right could interfere with normal operation of the camera or result in the batteries overheating, igniting, rupturing, or leaking.

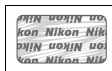

For more information about Nikon brand accessories, contact a local authorized Nikon dealer.

✔ Use Only Nikon Brand Accessories

Only Nikon brand accessories certified by Nikon specifically for use with your Nikon digital camera are engineered and proven to operate within its operational and safety requirements. THE USE OF NON-NIKON ACCESSORIES COULD DAMAGE YOUR CAMERA AND MAY VOID YOUR NIKON WARRANTY.

✍ Before Taking Important Pictures

Before taking pictures on important occasions (such as at weddings or before taking the camera on a trip), take a test shot to ensure that the camera is functioning normally. Nikon will not be held liable for damages or lost profits that may result from product malfunction.

✍ Life-Long Learning

As part of Nikon's "Life-Long Learning" commitment to ongoing product support and education, continually-updated information is available on-line at the following sites:

- **For users in the U.S.A.:** <http://www.nikonusa.com/>
- **For users in Europe and Africa:** <http://www.europe-nikon.com/support/>
- **For users in Asia, Oceania, and the Middle East:** <http://www.nikon-asia.com/>

Visit these sites to keep up-to-date with the latest product information, tips, answers to frequently-asked questions (FAQs), and general advice on digital imaging and photography. Additional information may be available from the Nikon representative in your area. See the following URL for contact information: <http://imaging.nikon.com/>

Location Data

Track logs: Location data will be recorded with pictures taken while **On** is selected for **Location data > Record location data** (☑ 45). In addition, if **Start** is selected for **Location data > Create log > Log location data** in the setup menu, the camera continues to log location data even while off. Radio waves produced by the device may affect medical equipment and aircraft navigation systems; in situations in which the use of satellite navigation devices is restricted or prohibited, such as in hospitals or aircraft, be sure to select **Off** for **Record location data** and turn the camera off.

Sharing location data: Note that addresses and other personal information may be inferred from the location data stored in track logs or embedded in images. Exercise caution when sharing images and track logs or when posting them to the Internet or other locations where they can be viewed by third parties. See “Disposing of Data Storage Devices” (☑ xi) for information on erasing location data before disposing of the camera or memory cards.

Navigation: The position, altitude, and other location data reported by the device are approximations only and are not intended for surveying or navigation. Be sure to take appropriate maps or other navigational devices with you when using the product during such outdoor activities as mountain climbing or hiking.

Restrictions on use: The location data function may not perform as expected in some countries or regions, including (as of November, 2013) China and in the vicinity of the Chinese border. Some countries, including China, prohibit unauthorized use of satellite navigation and other location data devices; before travelling, check with your travel agent or the embassy or tourism board of the countries you will be visiting. Where use is prohibited, select **Off** for **Record location data**.

Wireless

This product, which contains encryption software developed in the United States, is controlled by the United States Export Administration Regulations and may not be exported or re-exported to any country to which the United States embargoes goods. The following countries are currently subject to embargo: Cuba, Iran, North Korea, Sudan, and Syria.

Notices for Customers in the U. S. A.

This device complies with Part 15 of the FCC Rules. Operation is subject to the following two conditions: (1) this device may not cause harmful interference, and (2) this device must accept any interference received, including interference that may cause undesired operation.

FCC WARNING

The FCC requires the user to be notified that any changes or modifications made to this device that are not expressly approved by Nikon Corporation may void the user's authority to operate the equipment.

FCC Radio Frequency Interference Statement

Note: This equipment has been tested and found to comply with the limits for a Class B digital device, pursuant to part 15 of the FCC Rules. These limits are designed to provide reasonable protection against harmful interference in a residential installation. This equipment generates, uses and can radiate radio frequency energy and, if not installed and used in accordance with the instructions, may cause harmful interference to radio communications. However, there is no guarantee that interference will not occur in a particular installation. If this equipment does cause harmful interference to radio or television reception, which can be determined by turning the equipment off and on, the user is encouraged to try to correct the interference by one or more of the following measures:

- Reorient or relocate the receiving antenna.
- Increase the separation between the equipment and receiver.
- Connect the equipment into an outlet on a circuit different from that to which the receiver is connected.
- Consult the dealer or an experienced radio/TV technician for help.

Co-location

This transmitter must not be co-located or operated in conjunction with any other antenna or transmitter.

Nikon Inc., 1300 Walt Whitman Road, Melville, New York 11747-3064, U.S.A.

Tel.: 631-547-4200

Notices for Customers in Canada

This Class B digital apparatus complies with Canadian ICES-003.

This device complies with Industry Canada licence-exempt RSS standard(s). Operation is subject to the following two conditions: (1) this device may not cause interference, and (2) this device must accept any interference, including interference that may cause undesired operation of the device.

FCC/IC RF Exposure Statement

The available scientific evidence does not show that any health problems are associated with using low power wireless devices. There is no proof, however, that these low power wireless devices are absolutely safe. Low power Wireless devices emit low levels of radio frequency energy (RF) in the microwave range while being used. Whereas high levels of RF can produce health effects (by heating tissue), exposure of low-level RF that does not produce heating effects causes no known adverse health effects. Many studies of low-level RF exposures have not found any biological effects. Some studies have suggested that some biological effects might occur, but such findings have not been confirmed by additional research. The D5300, which is equipped with a LBWA1U5YR1 (FCC ID: VPYLBYSR650/IC ID: 772C-LBYR650) wireless LAN module, has been tested and found to comply with FCC/IC radiation exposure limits set forth for an uncontrolled environment and meets the FCC radio frequency (RF) Exposure Guidelines in Supplement C to OET65 and RSS-102 of the IC radio frequency (RF) Exposure rules. Please refer to the SAR test report that was uploaded to FCC website.

Notices for Customers in Europe

Hereby, Nikon, declares that the D5300 is in compliance with the essential requirements and other relevant provisions of Directive 1999/5/EC. The declaration of conformity may be consulted at

http://imaging.nikon.com/support/pdf/DoC_D5300.pdf



Notice for Customers in Singapore

Trade Name: Nikon Model: D5300
--

This device complies with radio-frequency regulations. The content of certification labels not affixed to the device is given below.

Complies with IMDA Standards DA104328

Security

Although one of the benefits of this product is that it allows others to freely connect for the wireless exchange of data anywhere within its range, the following may occur if security is not enabled:

- Data theft: Malicious third-parties may intercept wireless transmissions to steal user IDs, passwords, and other personal information.
- Unauthorized access: Unauthorized users may gain access to the network and alter data or perform other malicious actions. Note that due the design of wireless networks, specialized attacks may allow unauthorized access even when security is enabled.

Introduction

Getting to Know the Camera

Take a few moments to familiarize yourself with camera controls and displays. You may find it helpful to bookmark this section and refer to it as you read through the rest of the manual.

The Camera Body

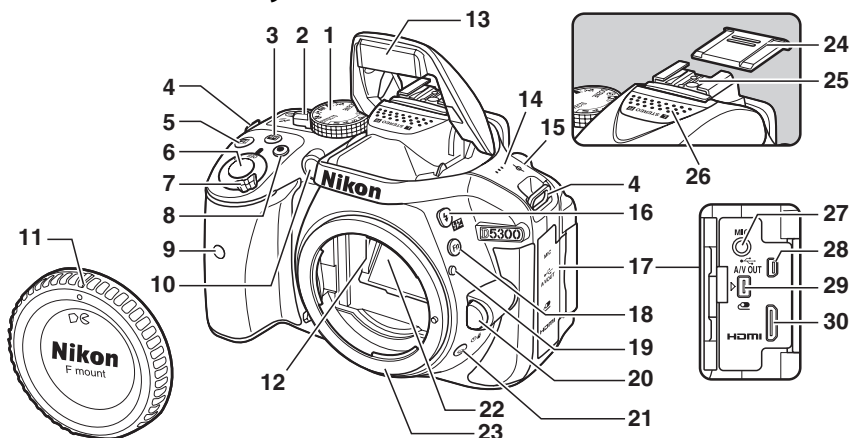

1 Mode dial.....3	11 Body cap	23 Lens mount11
2 Live view switch Live view22 Movie26	12 CPU contacts	24 Accessory shoe cover
3 info (information) button.....7	13 Built-in flash.....21	25 Accessory shoe (for optional flash units)
4 Eyelets for camera strap.....9	14 Speaker2	26 Stereo microphone.....28
5 AE-L/AF-ON button Exposure compensation...44 Adjusting aperture.....42 Flash compensation	15 Focal plane mark (☉)	27 Connector for external microphone
6 Shutter-release button.....19	16 Fn button 34, 41 Flash mode Flash compensation	28 USB and A/V connector Connecting to a computer61
7 Power switch.....2	17 Connector cover	29 Accessory terminal65
8 Movie-record button26	18 Fn button Using the Fn button 55	30 HDMI mini-pin connector
9 Infrared receiver for ML-L3 remote control (front)65	19 Mounting mark.....11	
10 AF-assist illuminator Self-timer lamp Red-eye reduction lamp	20 Lens release button16	
	21 OK button4 Continuous shooting4 Self-timer4 Remote control.....4	
	22 Mirror	

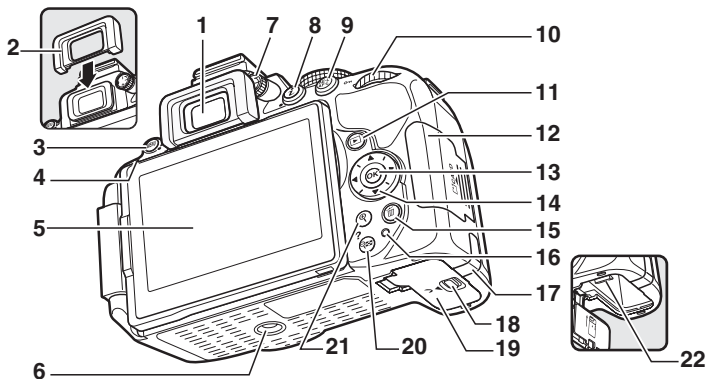

1 Viewfinder eyepiece..... 5, 14	9 AE-L/AF-ON button55 Protecting photographs from deletion	17 Power connector cover for optional power connector
2 Rubber eyecup	10 Command dial	18 Battery-chamber cover latch 10, 15
3 MENU button Menus..... 54	11 ▶ button Playback.....20	19 Battery-chamber cover 10, 15
4 Infrared receiver for ML-L3 remote control (rear) 65	12 Memory card slot cover..... 10, 15	20 Q / ? buttons..... 20 Thumbnails..... 20 Playback zoom out Help 54
5 Monitor Viewing settings.....7 Live view 22 Full-frame playback..... 20	13 OK (OK) button57	21 Q button20 Playback zoom in
6 Tripod socket	14 Multi selector.....57	22 Battery latch 10, 15
7 Diopter adjustment control 14	15 ⌫ button Deleting pictures during playback21	
8 i button Changing settings in the information display.....8	16 Memory card access lamp 19	

✓ The Speaker

Do not place the speaker in close proximity to magnetic devices. Failure to observe this precaution could affect the data recorded on the magnetic devices.

✎ The Power Switch

Rotate the power switch as shown to turn the camera on.

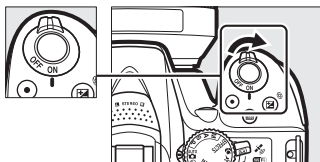

Rotate the power switch as shown to turn the camera off.

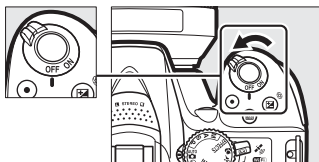

The Mode Dial

The camera offers a choice of the following shooting modes:









P, S, A, and M Modes

Select these modes for full control over camera settings.

- **P**—Programmed auto (□ 42)
- **S**—Shutter-priority auto (□ 42)
- **A**—Aperture-priority auto (□ 42)
- **M**—Manual (□ 42)



Special Effects Modes

Use special effects during shooting.

-  **Night vision** (□ 35)
-  **Color sketch** (□ 35, 37)
-  **Toy camera effect** (□ 35, 38)
-  **Miniature effect** (□ 36, 38)
-  **Selective color** (□ 36, 39)
-  **Silhouette** (□ 36)
-  **High key** (□ 36)
-  **Low key** (□ 36)
-  **HDR painting** (□ 36)

Auto Modes

Select these modes for simple, point-and-shoot photography.

-  **Auto** (□ 17)
-  **Auto (flash off)** (□ 17)

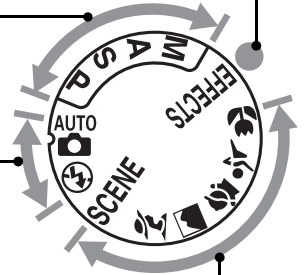





Scene Modes



The camera automatically optimizes settings to suit the scene selected with the mode dial. Match your selection to the scene being photographed.







- | | |
|--|--|
| <ul style="list-style-type: none">•  Portrait (□ 32)•  Landscape (□ 32)•  Child (□ 32) | <ul style="list-style-type: none">•  Sports (□ 32)•  Close up (□ 32)• SCENE Other scenes (□ 33) |
|--|--|

The (/) Button

To choose how the shutter is released (release mode), press the  (/) button, then highlight the desired option and press .



 (/) button

Mode	Description
	Single frame: Camera takes one photograph each time shutter-release button is pressed.
	Continuous L: The camera takes photographs at a slow rate while the shutter-release button is pressed.
	Continuous H: The camera takes photographs at a fast rate while the shutter-release button is pressed.
	Quiet shutter release: As for single-frame, except that camera noise is reduced.
	Self-timer: Take pictures using the self-timer. The timer starts when the shutter-release button is pressed all the way down, and the shutter is released after about 10 seconds.
	Delayed remote (ML-L3): Shutter is released 2 s after shutter-release button on optional ML-L3 remote control is pressed.
	Quick-response remote (ML-L3): Shutter is released when shutter-release button on optional ML-L3 remote control is pressed.

The Viewfinder

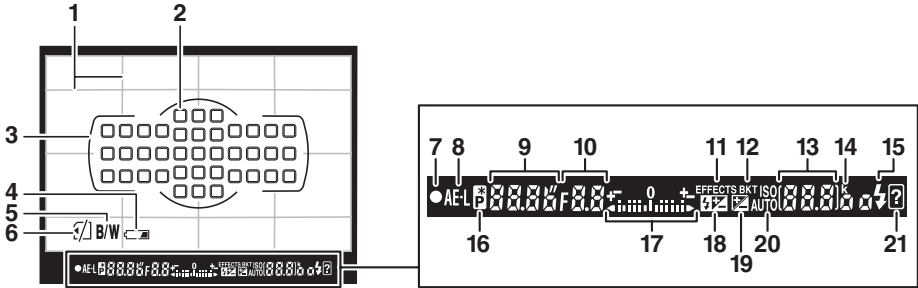
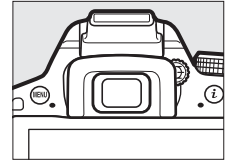

<p>1 Framing grid (displayed when On is selected for Custom Setting d2)55</p> <p>2 Focus points19</p> <p>3 AF area brackets 14, 18</p> <p>4 Low battery warning15</p> <p>5 Monochrome indicator (displayed in  mode or when the Monochrome Picture Control or a Picture Control based on Monochrome is selected)35</p> <p>6 “No memory card” indicator10</p> <p>7 Focus indicator19</p> <p>8 Autoexposure (AE) lock indicator</p> <p>9 Shutter speed43</p>	<p>10 Aperture (f-number) 43</p> <p>11 Special effects mode indicator 35</p> <p>12 Bracketing indicator</p> <p>13 Number of exposures remaining 13</p> <p>Number of shots remaining before memory buffer fills 19</p> <p>White balance recording indicator</p> <p>Exposure compensation value44</p> <p>Flash compensation value</p> <p>ISO sensitivity 8</p> <p>Capture mode indicator</p> <p>14 “k” (appears when memory remains for over 1000 exposures) 13</p>	<p>15 Flash-ready indicator21</p> <p>16 Flexible program indicator</p> <p>17 Exposure indicator43</p> <p>Exposure compensation display44</p> <p>Electronic rangefinder</p> <p>18 Flash compensation indicator</p> <p>19 Exposure compensation indicator44</p> <p>20 Auto ISO sensitivity indicator</p> <p>21 Warning indicator71</p>
---	--	---

Note: Display shown with all indicators lit for illustrative purposes.

 **The Viewfinder**
 The response time and brightness of the viewfinder display may vary with temperature.

The Monitor

The monitor can be angled and rotated as shown below.

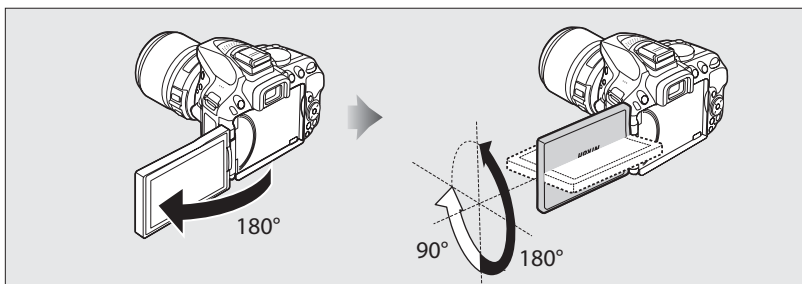

Normal use

Fold the monitor against the camera face out. This position is recommended for normal photography.

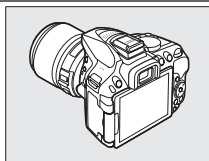

Low-angle shots

Frame live view shots with the camera close to the ground.

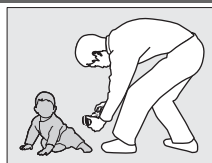
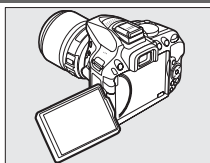

High-angle shots

Frame live view shots while holding the camera over your head.

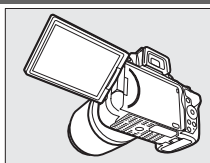

Self-portraits

Use for self-portraits in live view. The monitor shows a mirror image of what will appear in the final picture.

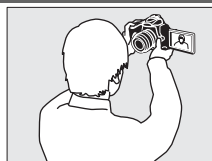
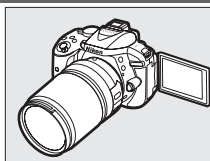

Using the Monitor

Rotate the monitor gently within the limits shown. *Do not use force.* Failure to observe these precautions could damage the connection between the monitor and the camera body. To protect the monitor when the camera is not in use, fold it back face down against the camera body.

The Information Display

Viewing settings: To view the information display, press the **Info** button.

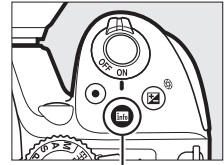

Info button

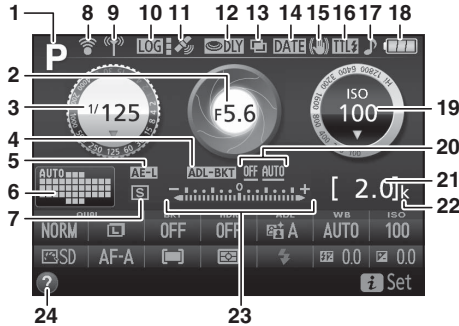

<p>1 Shooting mode AUTO auto/ Ⓢ auto (flash off)17 Scene modes31 Special effects mode.....35 P, S, A, and M modes.....41</p> <p>2 Aperture (f-number)43 Aperture display43</p> <p>3 Shutter speed43 Shutter-speed display43</p> <p>4 Bracketing indicator..... 8</p> <p>5 Autoexposure (AE) lock indicator</p> <p>6 Auto-area AF indicator 3D-tracking indicator Focus point.....19</p> <p>7 Release mode 4</p> <p>8 Eye-Fi connection indicator</p>	<p>9 Wi-Fi connection indicator 53</p> <p>10 Track log indicator</p> <p>11 Satellite signal indicator 46</p> <p>12 Exposure delay mode..... 55</p> <p>13 Multiple exposure indicator 55</p> <p>14 Print date indicator 55</p> <p>15 Vibration reduction indicator 16</p> <p>16 Flash control indicator Flash compensation indicator for optional flash units</p> <p>17 “Beep” indicator..... 55</p> <p>18 Battery indicator 15</p> <p>19 ISO sensitivity..... 8 ISO sensitivity display Auto ISO sensitivity indicator</p>	<p>20 ADL bracketing amount</p> <p>21 Number of exposures remaining13 White balance recording indicator Capture mode indicator</p> <p>22 “k” (appears when memory remains for over 1000 exposures).....13</p> <p>23 Exposure indicator.....43 Exposure compensation indicator.....44 Bracketing progress indicator</p> <p>24 Help icon71</p>
--	--	---

Note: Display shown with all indicators lit for illustrative purposes.

Turning the Monitor Off

To clear shooting information from the monitor, press the **Info** button or press the shutter-release button halfway. The monitor will turn off automatically if no operations are performed for about 8 seconds (Custom Setting c2, **Auto off timers**, can be used to choose how long the monitor remains on).

Changing settings: To change the settings at the bottom of the display, press the **i** button, then highlight items using the multi-selector and press **OK** to view options for the highlighted item.

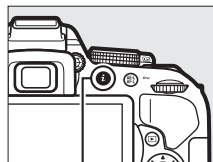

i button

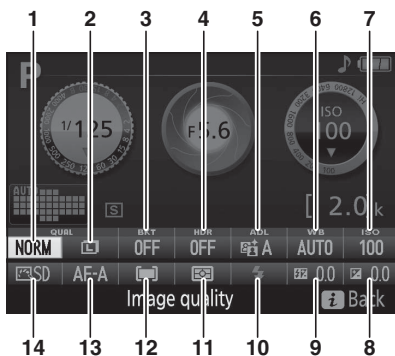

1	Image quality	Choose a file format and compression ratio.
2	Image size	Choose a size for new photos.
3	Auto bracketing	Choose the bracketing increment (exposure and white balance bracketing) or turn ADL bracketing on or off.
4	HDR (High Dynamic Range)	The camera combines two photographs taken at different exposures to enhance details in highlights and shadows.
5	Active D-Lighting	Improves the level of detail in highlights and shadows under high-contrast conditions.
6	White balance	Adjust settings for different types of lighting.
7	ISO sensitivity	Control the camera's sensitivity to light.
8	Exposure compensation	Adjust exposure from the value metered by the camera, making the entire frame brighter or darker.
9	Flash compensation	Adjust flash level.
10	Flash mode	Choose the flash mode.
11	Metering	Choose how the camera meters exposure.
12	AF-area mode	Choose how the focus area is selected.
13	Focus mode	Choose how the camera focuses.
14	Picture Control	Choose how the camera processes pictures.

First Steps

Always turn the camera off before inserting or removing batteries or memory cards.

1 Attach the strap.

Attach the strap as shown. Repeat for the second eyelet.

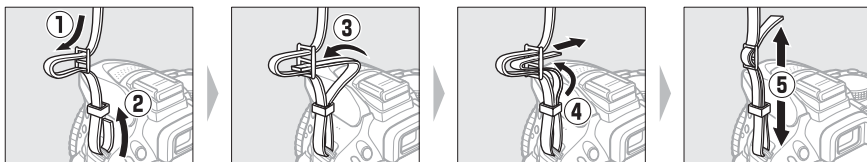

2 Charge the battery.

If a plug adapter is supplied, raise the wall plug and connect the plug adapter as shown below at left, making sure the plug is fully inserted. Insert the battery and plug the charger in. An exhausted battery will fully charge in about an hour and 50 minutes.

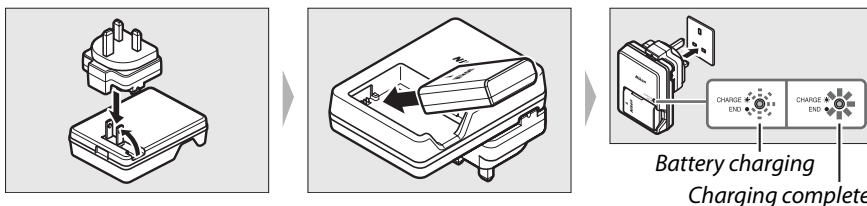

During Charging

Do not move the charger or touch the battery during charging. Failure to observe this precaution could in very rare instances result in the charger showing that charging is complete when the battery is only partially charged. Remove and reinsert the battery to begin charging again.

3 Insert the battery and memory card.

Insert the battery in the orientation shown, using the battery to keep the orange battery latch pressed to one side. The latch locks the battery in place when the battery is fully inserted.

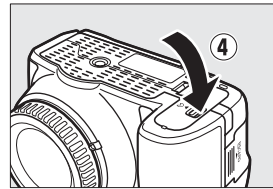
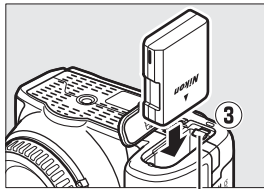
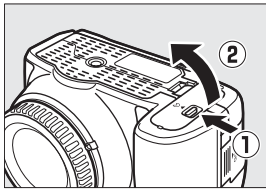

Battery latch

Slide the memory card in until it clicks into place.

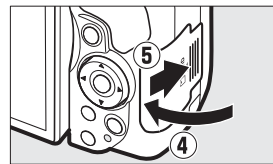
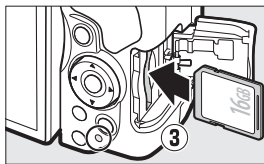
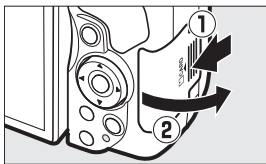

The Write Protect Switch

SD memory cards are equipped with a write protect switch to prevent accidental loss of data. When this switch is in the “lock” position, the memory card can not be formatted and photos can not be deleted or recorded (a beep will sound if you attempt to release the shutter). To unlock the memory card, slide the switch to the “write” position.

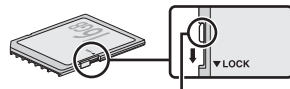

Write-protect switch

Memory Cards

- Memory cards may be hot after use. Observe due caution when removing memory cards from the camera.
- Turn the power off before inserting or removing memory cards. Do not remove memory cards from the camera, turn the camera off, or remove or disconnect the power source during formatting or while data are being recorded, deleted, or copied to a computer. Failure to observe these precautions could result in loss of data or in damage to the camera or card.
- Do not touch the card terminals with your fingers or metal objects.
- Do not bend, drop, or subject to strong physical shocks.
- Do not apply force to the card casing. Failure to observe this precaution could damage the card.
- Do not expose to water, heat, high levels of humidity, or direct sunlight.
- Do not format memory cards in a computer.

4 Attach a lens.

Be careful to prevent dust from entering the camera when the lens or body cap is removed.

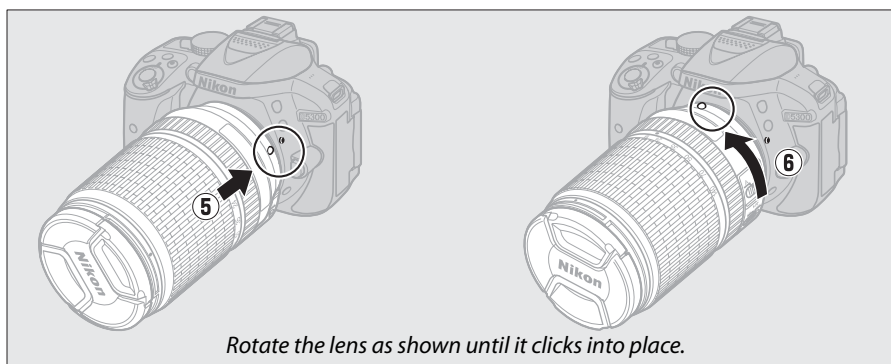
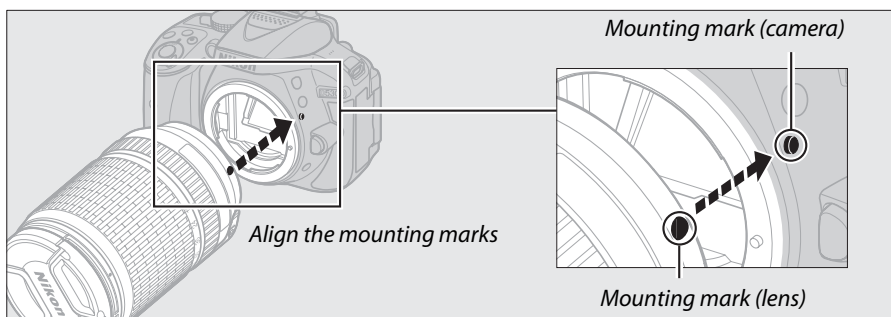
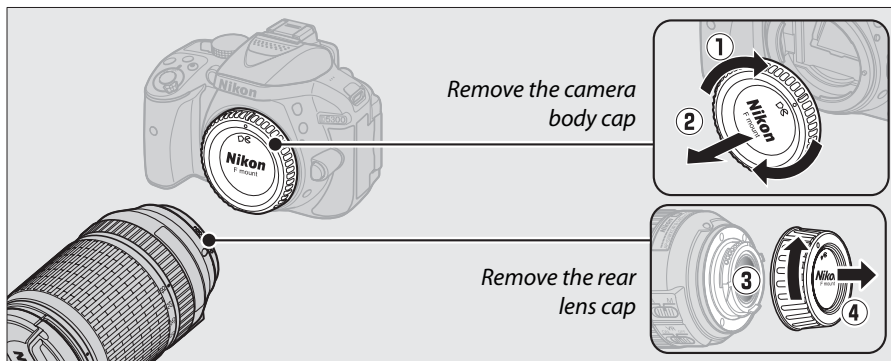

Be sure to remove the lens cap before taking pictures.

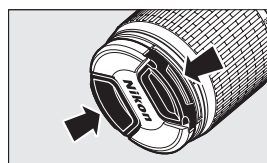

5 Open the monitor.

Open the monitor as shown. *Do not use force.*

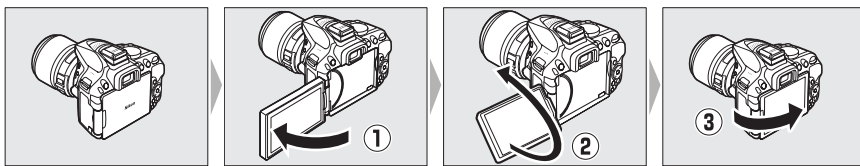

6 Turn the camera on.

A language-selection dialog will be displayed.

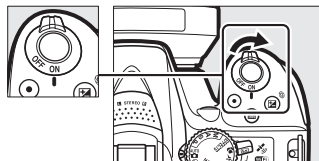

Lenses with Retractable Lens Barrel Buttons

Before using the camera, unlock and extend the zoom ring. Keeping the retractable lens barrel button pressed (1), rotate the zoom ring as shown (2).

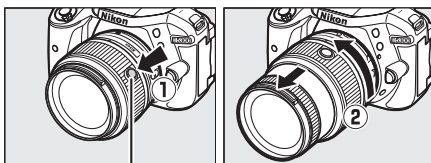

Retractable lens barrel button

Pictures can not be taken when the lens is retracted; if an error message is displayed as a result of the camera having been turned on with the lens retracted, rotate the zoom ring until the message is no longer displayed.



7 Choose a language and set the camera clock.

Use the multi selector and **OK** button to select a language and set the camera clock.

Move cursor up

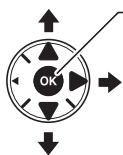

OK button: select highlighted item

Select highlighted item or display sub-menu

Move cursor down

- Select language
- Select time zone
- Select date format
- Select daylight saving time option
- Set time and date
(note that the camera uses a 24-hour clock)

8 Check the battery level and number of exposures remaining.

Press the **info** button and check the battery level and number of exposures remaining. In the case of exposures remaining, values over 1000 are shown in thousands, indicated by the letter “k”.

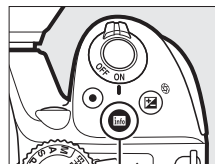

info button

Battery level (15)



Number of exposures remaining

9 Focus the viewfinder.

After removing the lens cap, rotate the diopter adjustment control until the AF area brackets are in sharp focus. When operating the control with your eye to the viewfinder, be careful not to put your fingers or fingernails in your eye.

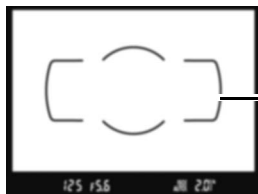
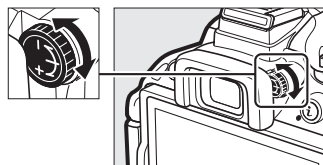

Viewfinder not in focus

AF area brackets

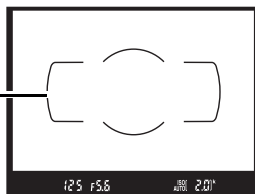

Viewfinder in focus

Charging the Battery







Read and follow the warnings and cautions on pages vi–viii and 68–70 of this manual. Charge the battery indoors at ambient temperatures of 5 °C–35 °C (41 °F–95 °F). Do not use the battery at ambient temperatures below 0 °C/32 °F or above 40 °C/104 °F; failure to observe this precaution could damage the battery or impair its performance. Capacity may be reduced and charging times may increase at battery temperatures from 0 °C/32 °F to 15 °C/59 °F and from 45 °C/113 °F to 60 °C/140 °F. The battery will not charge if its temperature is below 0 °C (32 °F) or above 60 °C (140 °F). If the **CHARGE** lamp flashes quickly (about eight times a second) during charging, confirm that the temperature is in the correct range and then unplug the charger and remove and reinsert the battery. If the problem persists, cease use immediately and take battery and charger to your retailer or a Nikon-authorized service representative.

Use the charger with compatible batteries only. Unplug when not in use.

Battery Level

Battery level is shown in the information display (if the battery is low, a warning will also be displayed in the viewfinder). If the information display does not appear when the **info** button is pressed, the battery is exhausted and needs to be recharged.



Information display	Viewfinder	Description
	—	Battery fully charged.
	—	Battery partially discharged.
		Low battery. Ready fully-charged spare battery or prepare to charge battery.
 (flashes)	 (flashes)	Battery exhausted. Charge battery.

Removing the Battery

To remove the battery, turn the camera off and open the battery-chamber cover. Press the battery latch in the direction shown by the arrow to release the battery and then remove the battery by hand.

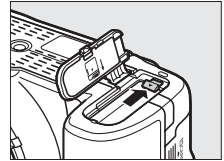

Formatting Memory Cards

If this is the first time the memory card will be used in the camera or if the card has been formatted in another device, select **Format memory card** in the setup menu and follow the on-screen instructions to format the card (□ 55). *Note that this permanently deletes any data the card may contain.* Be sure to copy any photographs and other data you wish to keep to a computer before proceeding.

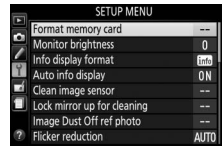

Removing Memory Cards

After confirming that the memory card access lamp is off, turn the camera off, open the memory card slot cover, and press the card in to eject it (①). The card can then be removed by hand (②).

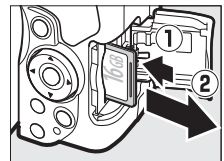

A-M, M/A-M, and A/M-M Switches

When using autofocus with a lens equipped with an **A-M** mode switch, slide the switch to **A** (if the lens has an **M/A-M** or **A/M-M** switch, select **M/A** or **A/M**). For information on other lenses that can be used with this camera, see page 63.



Vibration Reduction (VR)

Vibration reduction can be enabled by selecting **On** for **Optical VR** in the shooting menu, if the lens supports this option, or by sliding the lens vibration reduction switch to **ON**, if the lens is equipped with a vibration reduction display switch. A vibration reduction indicator appears in the information display when vibration reduction is on.



Detaching the Lens

Be sure the camera is off when removing or exchanging lenses. To remove the lens, press and hold the lens release button (1) while turning the lens clockwise (2). After removing the lens, replace the lens caps and camera body cap.

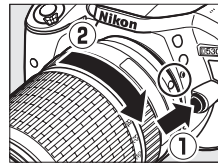

Retracting Lenses with Retractable Lens Barrel Buttons

To retract the lens when the camera is not in use, hold the retractable lens barrel button (1) and rotate the zoom ring to the "L" (lock) position as shown (2). Retract the lens before removing it from the camera, and be careful not to press the retractable lens barrel button when attaching or removing the lens.

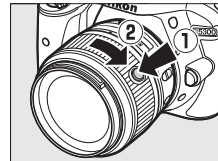

The Camera Clock



The camera clock is less accurate than most watches and household clocks. Check the clock regularly against more accurate time pieces and reset as necessary.

The Clock Battery



The camera clock is powered by an independent, rechargeable power source, which is charged as necessary when the main battery is installed. Three days of charging will power the clock for about a month. If a message warning that the clock is not set is displayed when the camera is turned on, the clock battery is exhausted and the clock has been reset. Set the clock to the correct time and date.

“Point-and-Shoot” Modes

(and)

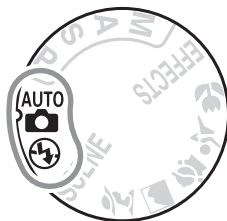
This section describes how to shoot photographs and movies in  and  modes, automatic “point-and-shoot” modes in which the majority of settings are controlled by the camera in response to shooting conditions.



Before proceeding, turn the camera on and rotate the mode dial to  or  (the only difference between the two is that the flash will not fire in  mode).

Mode dial

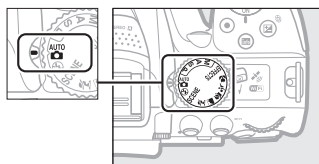

Viewfinder photography



Taking photographs	18
Viewing photographs	20
Deleting photographs	21

Live view



Taking photographs	22
Viewing photographs	25
Deleting photographs	25
Shooting movies	26



Viewing movies	29
Deleting movies	30

Framing Photos in the Viewfinder

1 Ready the camera.

When framing photographs in the viewfinder, hold the handgrip in your right hand and cradle the camera body or lens with your left.

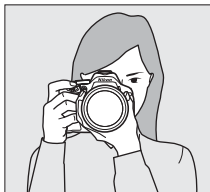

When framing photographs in portrait (tall) orientation, hold the camera as shown at right.

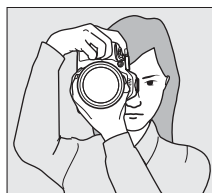

2 Frame the photograph.

Frame a photograph in the viewfinder with the main subject in the AF area brackets.

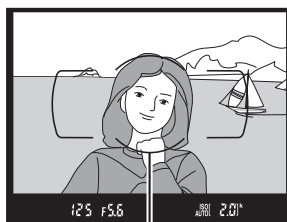

AF area brackets

Using a Zoom Lens

Before focusing, rotate the zoom ring to adjust the focal length and frame the photograph. Use the zoom ring to zoom in on the subject so that it fills a larger area of the frame, or zoom out to increase the area visible in the final photograph (select longer focal lengths on the lens focal length scale to zoom in, shorter focal lengths to zoom out).

If the lens is equipped with a retractable lens barrel button ( 12), press and hold the button while rotating the zoom ring until the lens is released and the message shown at right is no longer displayed, and then adjust zoom using the zoom ring.

Zoom in

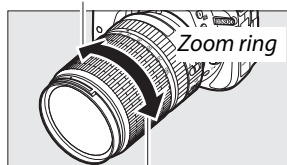

Zoom out



3 Press the shutter-release button halfway.

Press the shutter-release button halfway to focus (if the subject is poorly lit, the flash may pop up and the AF-assist illuminator may light). When the focus operation is complete, a beep will sound (a beep may not sound if the subject is moving) and the active focus point and in-focus indicator (●) will appear in the viewfinder.

In-focus indicator	Description
●	Subject in focus.
● (flashes)	Camera unable to focus using autofocus. See page 72.



Focus point

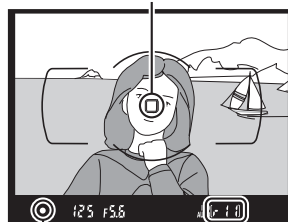

In-focus indicator

Buffer capacity

4 Shoot.

Smoothly press the shutter-release button the rest of the way down to take the photograph. The memory card access lamp will light and the photograph will be displayed in the monitor for a few seconds. *Do not eject the memory card or remove or disconnect the power source until the lamp has gone out and recording is complete.*

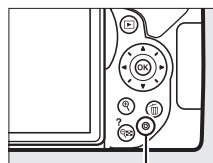

Memory card access lamp



The Shutter-Release Button

The camera has a two-stage shutter-release button. The camera focuses when the shutter-release button is pressed halfway. To take the photograph, press the shutter-release button the rest of the way down.

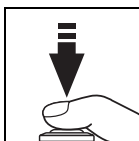

Focus: press halfway

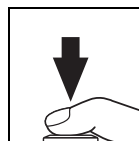

Shoot: press all the way down

Pressing the shutter-release button halfway also ends playback and readies the camera for immediate use.

Viewing Photographs



Pressing  displays a picture in the monitor.



Press ◀ or ▶ to view additional pictures.



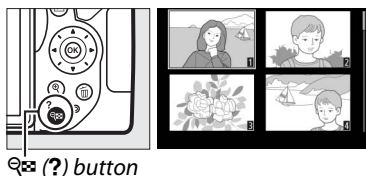

Thumbnail Playback

To display images in "contact sheets" of four, 12, or 80 images (thumbnail playback), press the  (?) button. Use the multi selector or command dial to highlight images and press  to display the highlighted image full frame. Press  to reduce the number of images displayed.



Calendar Playback

To view images taken on a selected date (calendar playback), press the  (?) button when 80 images are displayed. Press the  (?) button to toggle between the date list and the list of thumbnails for the selected date. Use the multi selector to highlight dates in the date list or to highlight pictures in the thumbnail list. Press  when the cursor is in the date list to return to 80-frame playback.

Thumbnail list



Date list

Deleting Unwanted Pictures

Display the photograph you wish to delete.



Press ; a confirmation dialog will be displayed.



Press the button again to delete the picture.

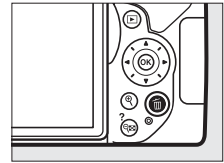

The Standby Timer

The viewfinder and information display will turn off if no operations are performed for about eight seconds, reducing the drain on the battery. Press the shutter-release button halfway to reactivate the display. The length of time before the standby timer expires automatically can be selected using Custom Setting c2 (**Auto off timers**; 55).

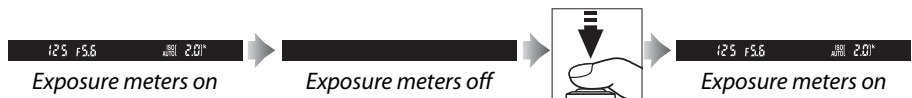

The Built-in Flash

If additional lighting is required for correct exposure in mode, the built-in flash will pop up automatically when the shutter-release button is pressed halfway (19). If the flash is raised, photographs can only be taken when the flash-ready indicator () is displayed. If the flash-ready indicator is not displayed, the flash is charging; remove your finger briefly from the shutter-release button and try again.

When the flash is not in use, return it to its closed position by pressing it gently downward till the latch clicks into place.

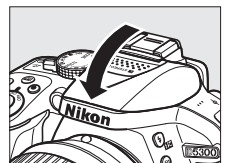
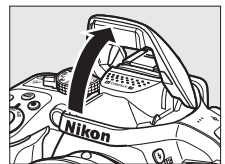

Framing Photos in the Monitor

1 Rotate the live view switch.

The view through the lens will be displayed in the camera monitor (live view).

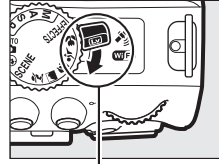

Live view switch

2 Ready the camera.

Hold the handgrip in your right hand and cradle the camera body or lens with your left.



When framing photographs in portrait (tall) orientation, hold the camera as shown at right.



3 Focus.

Press the shutter-release button halfway. The focus point will flash green while the camera focuses. If the camera is able to focus, the focus point will be displayed in green; if the camera is unable to focus, the focus point will flash red.





Focus point

4 Take the picture.

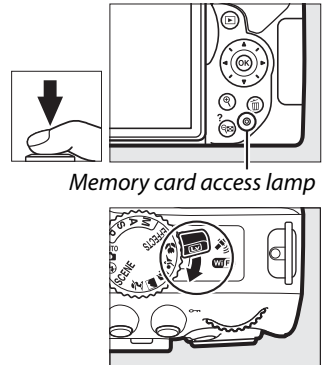







Press the shutter-release button the rest of the way down. The monitor turns off and the memory card access lamp lights during recording. *Do not eject the memory card or remove or disconnect the power source until the lamp has gone out and recording is complete.* When recording is complete, the photograph will be displayed in the monitor for a few seconds. Rotate the live view switch to exit live view.



Automatic Scene Selection (Scene Auto Selector)

If live view is selected in  or  mode, the camera will automatically analyze the subject and select the appropriate shooting mode when autofocus is enabled. The selected mode is shown in the monitor.



	Portrait	Human portrait subjects
	Landscape	Landscapes and cityscapes
	Close up	Subjects close to the camera
	Night portrait	Portrait subjects framed against a dark background
	Auto	Subjects suited to  or  mode or that do not fall into the categories listed above
	Auto (flash off)	

✔ Shooting in Live View Mode

Although they will not appear in the final picture, distortion may be visible in the monitor if the camera is panned horizontally or an object moves at high speed through frame. Bright light sources may leave after-images in the monitor when the camera is panned. Bright spots may also appear. Flicker and banding visible in the monitor under fluorescent, mercury vapor, or sodium lamps can be reduced using **Flicker reduction** (□ 55), although they may still be visible in the final photograph at some shutter speeds. When shooting in live view mode, avoid pointing the camera at the sun or other strong light sources. Failure to observe this precaution could result in damage to the camera's internal circuitry.

Live view ends automatically when the monitor is closed (closing the monitor does not end live view on televisions or other external displays).

Live view may end automatically to prevent damage to the camera's internal circuits; exit live view when the camera is not in use. Note that the temperature of the camera's internal circuits may rise and noise (bright spots, randomly-spaced bright pixels, or fog) may be displayed in the following instances (the camera may also become noticeably warm, but this does not indicate a malfunction):

- The ambient temperature is high
- The camera has been used for extended periods in live view or to record movies
- The camera has been used in continuous release mode for extended periods

If live view does not start when you attempt to start live view, wait for the internal circuits to cool and then try again.



✔ The Count Down Display

A count down will be displayed 30 s before live view ends automatically (the timer turns red 5 s before the auto off timer expires (□ 55) or if live view is about to end to protect the internal circuits). Depending on shooting conditions, the timer may appear immediately when live view is selected.

Viewing Photographs

Pressing  displays a picture in the monitor.



Press  or  to view additional pictures.



Deleting Unwanted Pictures

Display the photograph you wish to delete.



Press ; a confirmation dialog will be displayed.



Press the  button again to delete the picture.

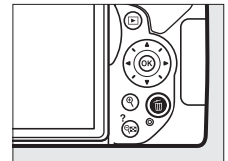

Recording Movies

Movies can be recorded in live view mode.

1 Rotate the live view switch.

The view through the lens is displayed in the monitor.

The Icon

A  icon indicates that movies can not be recorded.

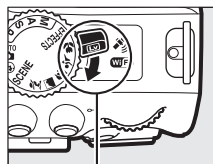

Live view switch

2 Ready the camera.

Hold the handgrip in your right hand and cradle the camera body or lens with your left.



3 Focus.

Press the shutter-release button halfway to focus.



Focus point

4 Start recording.

Press the movie-record button to start recording. A recording indicator and the time available are displayed in the monitor.

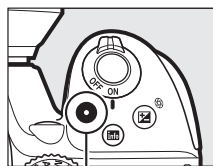

Movie-record button

Recording indicator

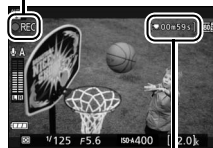

Time remaining

5 End recording.

Press the movie-record button again to end recording. Recording will end automatically when the maximum length is reached, the memory card is full, another mode is selected, or the monitor is closed (closing the monitor does not end recording on televisions or other external displays). Rotate the live view switch to exit live view.

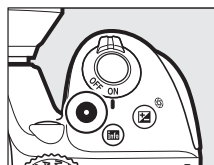

Maximum Length

The maximum size for individual movie files is 4 GB; maximum length varies with the options selected for **Movie settings > Frame size/frame rate** and **Movie quality** as shown below. Note that depending on memory card write speed, shooting may end before this length is reached (☐ 66).

	Frame size/frame rate		Maximum length (high movie quality ★/ normal movie quality) ⁴
	Frame size (pixels)	Frame rate ¹	
$\frac{1080 \text{ PA}}{50} / \frac{1080 \text{ P}}{50}$	1920 × 1080	60p ²	10 min./20 min.
$\frac{1080 \text{ PA}}{50} / \frac{1080 \text{ P}}{50}$		50p ³	
$\frac{1080 \text{ PA}}{50} / \frac{1080 \text{ P}}{50}$		30p ²	20 min./29 min. 59 s
$\frac{1080 \text{ PA}}{50} / \frac{1080 \text{ P}}{50}$		25p ³	
$\frac{1080 \text{ PA}}{50} / \frac{1080 \text{ P}}{50}$		24p	
$\frac{720 \text{ PA}}{50} / \frac{720 \text{ P}}{50}$	1280 × 720	60p ²	29 min. 59 s / 29 min. 59 s
$\frac{720 \text{ PA}}{50} / \frac{720 \text{ P}}{50}$		50p ³	
$\frac{424 \text{ PA}}{50} / \frac{424 \text{ P}}{50}$	640 × 424	30p ²	29 min. 59 s / 29 min. 59 s
$\frac{424 \text{ PA}}{50} / \frac{424 \text{ P}}{50}$		25p ³	

1 Listed value. Actual frame rates for 60p, 50p, 30p, 25p, and 24p are 59.94, 50, 29.97, 25, and 23.976 fps respectively.

2 Available when **NTSC** is selected for **Video mode** (☐ 55).

3 Available when **PAL** is selected for **Video mode**.

4 Movies recorded in miniature effect mode are up to three minutes long when played back.

✓ **Recording Movies**

Flicker, banding, or distortion may be visible in the monitor and in the final movie under fluorescent, mercury vapor, or sodium lamps or if the camera is panned horizontally or an object moves at high speed through frame (flicker and banding can be reduced using **Flicker reduction**; □ 55). Bright light sources may leave after-images when the camera is panned. Jagged edges, color fringing, moiré, and bright spots may also appear. Bright bands may appear in some areas of the frame if the subject is briefly illuminated by a flash or other bright, momentary light source. When recording movies, avoid pointing the camera at the sun or other strong light sources. Failure to observe this precaution could result in damage to the camera's internal circuitry.

The camera can record both video and sound; do not cover the microphone during recording. Note that the built-in microphone may record lens noise during autofocus and vibration reduction.

Flash lighting can not be used during movie recording.

Live view may end automatically to prevent damage to the camera's internal circuits; exit live view when the camera is not in use. Note that the temperature of the camera's internal circuits may rise and noise (bright spots, randomly-spaced bright pixels, or fog) may be displayed in the following instances (the camera may also become noticeably warm, but this does not indicate a malfunction):



- The ambient temperature is high
- The camera has been used for extended periods in live view or to record movies
- The camera has been used in continuous release mode for extended periods

If live view does not start when you attempt to start live view or movie recording, wait for the internal circuits to cool and then try again.

✓ **The Count-Down Display**

A count down will be displayed 30 s before live view ends automatically. Depending on shooting conditions, the timer may appear immediately when movie recording begins. Note that regardless of the amount of recording time available, live view will still end automatically when the timer expires. Wait for the internal circuits to cool before resuming movie recording.

Viewing Movies

Press  to start playback and then scroll through pictures until a movie (indicated by a  icon) is displayed.

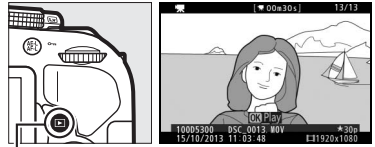





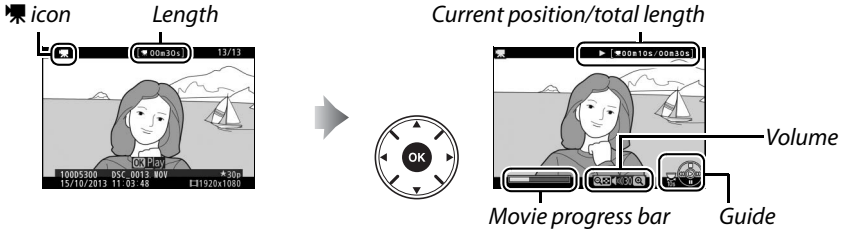







 button

Press  to start playback; your current position is indicated by the movie progress bar.





The following operations can be performed:

To	Use	Description
Pause		Pause playback.
Play		Resume playback when movie is paused or during rewind/advance.
Advance/ rewind		Speed increases with each press, from 2x to 4x to 8x to 16x; keep pressed to skip to beginning or end of movie (first frame is indicated by  in top right corner of monitor, last frame by ). If playback is paused, movie rewinds or advances one frame at a time; hold for continuous rewind or advance.
Skip 10 s		Rotate the command dial to skip ahead or back 10 s.
Adjust volume	 (?)	Press  to increase volume,  (?) to decrease.
Return to full-frame playback	 / 	Press  or  to exit to full-frame playback.

Deleting Unwanted Movies

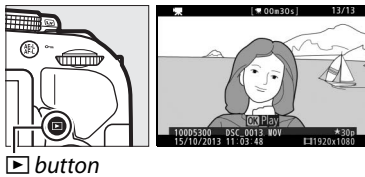
Display the movie you wish to delete (movies are indicated by  icons).



Press ; a confirmation dialog will be displayed.

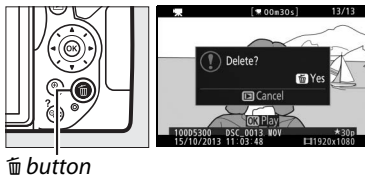

Press the  button again to delete the movie.

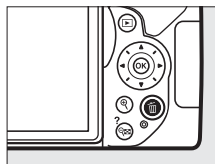

Matching Settings to the Subject or Situation (Scene Mode)

The camera offers a choice of “scene” modes. Choosing a scene mode automatically optimizes settings to suit the selected scene, making creative photography as simple as selecting a mode, framing a picture, and shooting as described on page 17.

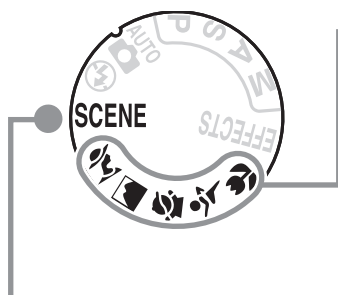

The scenes listed below can be selected with the mode dial.





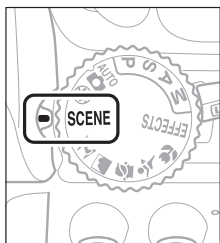



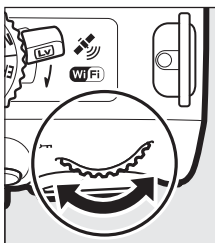

-  Portrait
-  Landscape
-  Child
-  Sports
-  Close up

The following scenes can be selected by rotating the mode dial to **SCENE** and rotating the command dial until the desired scene appears in the monitor.



+



-  Night Portrait
-  Night Landscape
-  Party/Indoor
-  Beach/Snow
-  Sunset
-  Dusk/Dawn
-  Pet Portrait
-  Candlelight
-  Blossom
-  Autumn Colors
-  Food

The Mode Dial

The following scenes can be selected with the mode dial:

Mode dial

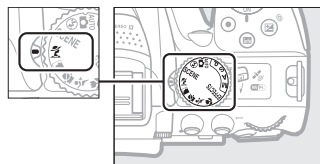

Portrait

Use for portraits with soft, natural-looking skin tones. If the subject is far from the background or a telephoto lens is used, background details will be softened to lend the composition a sense of depth.

Landscape

Use for vivid landscape shots in daylight.

Note: The built-in flash and AF-assist illuminator turn off.

Child

Use for snapshots of children. Clothing and background details are vividly rendered, while skin tones remain soft and natural.

Sports

Fast shutter speeds freeze motion for dynamic sports shots in which the main subject stands out clearly.

Note: The built-in flash and AF-assist illuminator turn off.

Close up

Use for close-up shots of flowers, insects, and other small objects (a macro lens can be used to focus at very close ranges).

Other Scenes

The following scenes can be selected by rotating the mode dial to **SCENE** and rotating the command dial until the desired scene appears in the monitor.

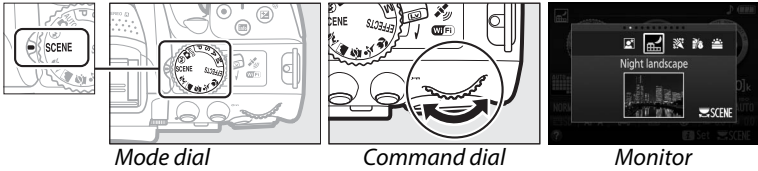

Night Portrait

Use for a natural balance between the main subject and the background in portraits taken under low light.

Night Landscape

Reduce noise and unnatural colors when photographing night landscapes, including street lighting and neon signs.

Note: The built-in flash and AF-assist illuminator turn off.

Party/Indoor

Capture the effects of indoor background lighting. Use for parties and other indoor scenes.

Beach/Snow

Capture the brightness of sunlit expanses of water, snow, or sand.

Note: The built-in flash and AF-assist illuminator turn off.

Sunset

Preserves the deep hues seen in sunsets and sunrises.

Note: The built-in flash and AF-assist illuminator turn off.

Dusk/Dawn

Preserves the colors seen in the weak natural light before dawn or after sunset.

Note: The built-in flash and AF-assist illuminator turn off.

Pet Portrait

Use for portraits of active pets.

Note: The AF-assist illuminator turns off.

Candlelight

For photographs taken by candlelight.

Note: The built-in flash turns off.

Blossom

Use for fields of flowers, orchards in bloom, and other landscapes featuring expanses of blossoms.

Note: The built-in flash turns off.

Autumn Colors

Captures the brilliant reds and yellows in autumn leaves.

Note: The built-in flash turns off.

Food

Use for vivid photographs of food.





Note: For flash photography, press the  (🔦) button to raise the flash.





Preventing Blur

Use a tripod to prevent blur caused by camera shake at slow shutter speeds.

Special Effects

Special effects can be used when recording images.

 Night Vision
 Color Sketch
 Toy Camera Effect
 Miniature Effect
 Selective Color

 Silhouette
 High Key
 Low Key
 HDR Painting



The following effects can be selected by rotating the mode dial to **EFFECTS** and rotating the command dial until the desired option appears in the monitor.

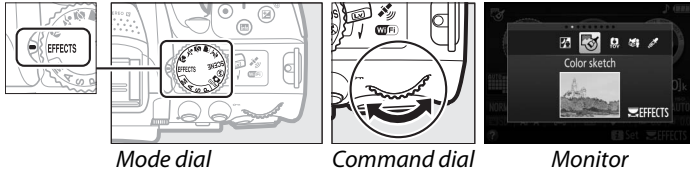

Mode dial

Command dial

Monitor

Night Vision

Use under conditions of darkness to record monochrome images at high ISO sensitivities.

Note: Pictures may be affected by noise in the form of randomly-spaced bright pixels, fog, or lines. Autofocus is available in live view only; manual focus can be used if the camera is unable to focus. The built-in flash and AF-assist illuminator turn off.

Color Sketch

The camera detects and colors outlines for a color sketch effect. The effect can be adjusted in live view (☞ 37).

Note: Movies shot in this mode play back like a slide show made up of a series of stills.

Toy Camera Effect

Create photos and movies that appear to have been shot with a toy camera. The effect can be adjusted in live view (☞ 38).

Miniature Effect

Create photos that appear to be pictures of dioramas. Works best when shooting from a high vantage point. Miniature effect movies play back at high speed, compressing about 45 minutes of footage shot at 1920 × 1080/30p into a movie that plays back in about three minutes. The effect can be adjusted in live view (☐ 38).

Note: Sound is not recorded with movies. The built-in flash and AF-assist illuminator turn off.

Selective Color

All colors other than the selected colors are recorded in black and white. The effect can be adjusted in live view (☐ 39).

Note: The built-in flash turns off.

Silhouette

Silhouette subjects against bright backgrounds.

Note: The built-in flash turns off.

High Key

Use with bright scenes to create bright images that seem filled with light.

Note: The built-in flash turns off.

Low Key

Use with dark scenes to create dark, low-key images with prominent highlights.

Note: The built-in flash turns off.

HDR Painting

Each time a photo is taken, the camera shoots two frames at different exposures and combines them for a painterly effect that emphasizes detail and color.

Note: The effect can not be previewed in live view. Note that the desired results may not be achieved if the camera or subject move during shooting. During recording, a message is displayed and no further photos can be taken. The built-in flash turns off, continuous shooting is disabled, and movies are recorded in (📷) mode.

Preventing Blur

Use a tripod to prevent blur caused by camera shake at slow shutter speeds.

Options Available in Live View

■ ■ Color Sketch

1 Select live view.

Rotate the live view switch. The view through the lens will be displayed in the monitor.

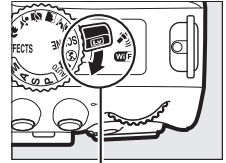

Live view switch

2 Adjust options.



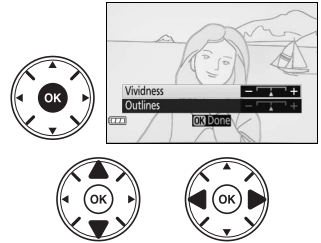



Press **OK** to display the options shown at right. Press **▲** or **▼** to highlight **Vividness** or **Outlines** and press **◀** or **▶** to change. Vividness can be increased to make colors more saturated, or decreased for a washed-out, monochromatic effect, while outlines can be made thicker or thinner. Increasing the thickness of the lines also makes colors more saturated.



3 Press **OK**.

Press **OK** to exit when settings are complete. To exit live view, rotate the live view switch. The selected settings will continue in effect and will apply to photographs taken using the viewfinder.

NEF (RAW)

NEF (RAW) recording is not available in , , , , , and  modes. Pictures taken when an NEF (RAW) or NEF (RAW)+JPEG option is selected in these modes will be recorded as JPEG images. JPEG images created at settings of NEF (RAW)+JPEG will be recorded at the selected JPEG quality, while images recorded at a setting of NEF (RAW) will be recorded as fine-quality images.

and Modes

Autofocus is not available during movie recording. The live view refresh rate will drop, together with the frame rate for continuous release modes; using autofocus during live view photography will disrupt the preview.

Toy Camera Effect

1 Select live view.

Rotate the live view switch. The view through the lens will be displayed in the monitor.

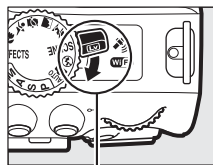

Live view switch

2 Adjust options.

Press **OK** to display the options shown at right. Press **▲** or **▼** to highlight **Vividness** or **Vignetting** and press **◀** or **▶** to change. Adjust vividness to make colors more or less saturated, vignetting to control the amount of vignetting.

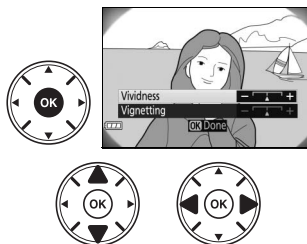

3 Press **OK**.

Press **OK** to exit when settings are complete. To exit live view, rotate the live view switch. The selected settings will continue in effect and will apply to photographs taken using the viewfinder.

Miniature Effect

1 Select live view.

Rotate the live view switch. The view through the lens will be displayed in the monitor.

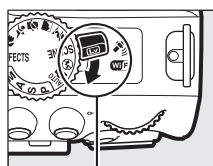

Live view switch

2 Position the focus point.

Use the multi selector to position the focus point in the area that will be in focus and then press the shutter-release button halfway to focus. To temporarily clear miniature effect options from the display and enlarge the view in the monitor for precise focus, press . Press (?) to restore the miniature effect display.



3 Display options.

Press to display miniature effect options.



4 Adjust options.

Press or to choose the orientation of the area that will be in focus and press or to adjust its width.

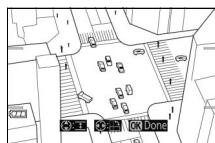

5 Return to the live view display.

Press to return to live view. To exit live view, rotate the live view switch. The selected settings will continue in effect and will apply to photographs taken using the viewfinder.

Selective Color

1 Select live view.

Rotate the live view switch. The view through the lens will be displayed in the monitor.

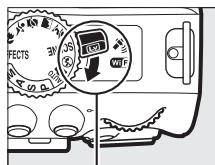

Live view switch

2 Display options.

Press to display selective color options.



3 Select a color.

Frame an object in the white square in the center of the display and press **▲** to choose the color of the object as one that will remain in the final image (the camera may have difficulty detecting unsaturated colors; choose a saturated color). To zoom in on the center of the display for more precise color selection, press **Q**. Press **Q** (?) to zoom out.

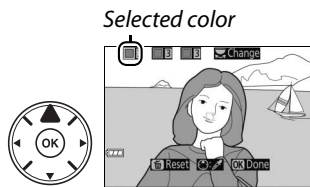

4 Choose the color range.

Press **▲** or **▼** to increase or decrease the range of similar hues that will be included in the final image. Choose from values between 1 and 7; note that higher values may include hues from other colors.

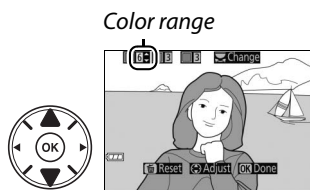

5 Select additional colors.

To select additional colors, rotate the command dial to highlight another of the three color boxes at the top of the display and repeat Steps 3 and 4 to select another color. Repeat for a third color if desired. To deselect the highlighted color, press **⏏** (To remove all colors, press and hold **⏏**. A confirmation dialog will be displayed; select **Yes**).

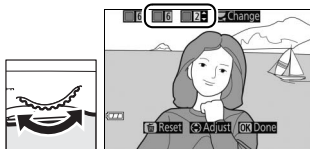

6 Return to the live view display.

Press **Ⓚ** to return to live view. During shooting, only objects of the selected hues will be recorded in color; all others will be recorded in black-and-white. To exit live view, rotate the live view switch. The selected settings will continue in effect and will apply to photographs taken using the viewfinder.

P, S, A, and M Modes

P, S, A, and M modes offer different degrees of control over shutter speed and aperture:



Mode	Description
P Programmed auto (□ 42)	Recommended for snapshots and in other situations in which there is little time to adjust camera settings. Camera sets shutter speed and aperture for optimal exposure.
S Shutter-priority auto (□ 42)	Use to freeze or blur motion. User chooses shutter speed; camera selects aperture for best results.
A Aperture-priority auto (□ 42)	Use to blur background or bring both foreground and background into focus. User chooses aperture; camera selects shutter speed for best results.
M Manual (□ 42)	User controls both shutter speed and aperture. Set shutter speed to “Bulb” or “Time” for long time-exposures.

Using the Built-in Flash

For flash photography, press the  button to raise the flash.

Mode P (Programmed Auto)

This mode is recommended for snapshots or whenever you want to leave the camera in charge of shutter speed and aperture. The camera automatically adjusts shutter speed and aperture for optimal exposure in most situations.

Mode S (Shutter-Priority Auto)

In shutter-priority auto, you choose the shutter speed while the camera automatically selects the aperture that will produce the optimal exposure.

Rotate the command dial to choose the desired shutter speed: rotate right for faster speeds, left for slower speeds.

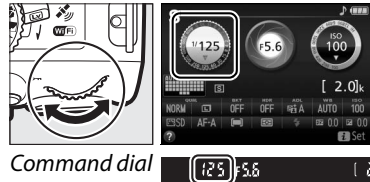

Command dial

Mode A (Aperture-Priority Auto)

In aperture-priority auto, you choose the aperture while the camera automatically selects the shutter speed that will produce the optimal exposure.

Rotate the command dial left for larger apertures (lower f-numbers), right for smaller apertures (higher f-numbers).

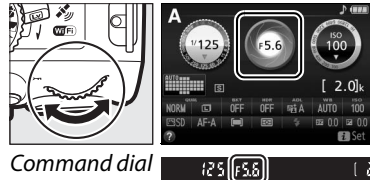

Command dial

Mode M (Manual)

In manual mode, you control both shutter speed and aperture.

Checking the exposure indicator, adjust shutter speed and aperture. Shutter speed is selected by rotating the command dial (right for faster speeds, left for slower). To adjust aperture, keep the  button pressed while rotating the command dial (left for larger apertures/lower f-numbers and right for smaller apertures/higher f-numbers).

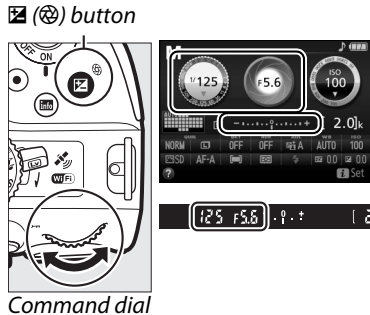

Command dial

✎ Shutter Speed and Aperture

Shutter speed and aperture are shown in the viewfinder and information display.

Shutter speed

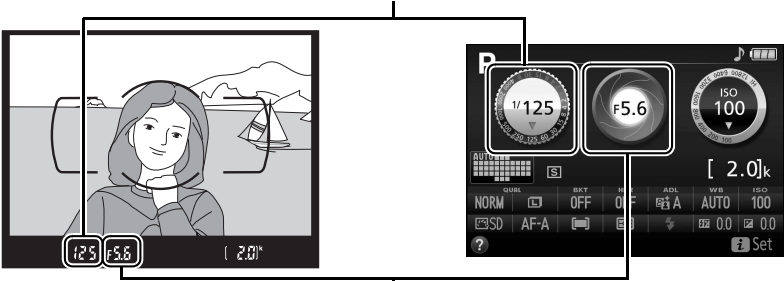

Aperture



Fast shutter speeds ($1/1600$ s in this example) freeze motion.

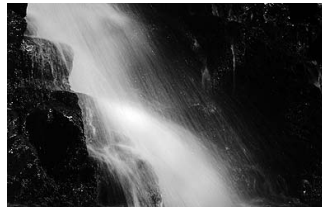

Slow shutter speeds (here 1 s) blur motion.



Large apertures (such as f/5.6; remember, the lower the f-number, the larger the aperture) blur details in front of and behind the main subject.



Small apertures (f/22 in this case) bring both background and foreground into focus.

✎ The Exposure Indicator

Optimal exposure	Underexposed by $1/3$ EV	Overexposed by over 2 EV

Exposure Compensation

Exposure compensation is used to alter exposure from the value suggested by the camera, making pictures brighter or darker (☐ 75).





-1 EV





No exposure compensation

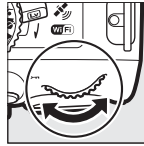
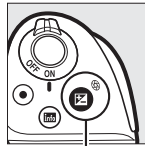

+1 EV

To choose a value for exposure compensation, keep the  button pressed and rotate the command dial until the desired value is selected in the viewfinder or information display. Normal exposure can be restored by setting exposure compensation to ± 0 (adjustments to exposure compensation in  mode will be reset when another mode is selected). Exposure compensation is not reset when the camera is turned off.



 button Command dial



-0.3 EV

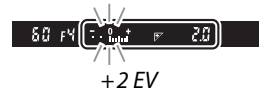

+2 EV

The Information Display

Exposure compensation options can also be accessed from the information display (☐ 8).

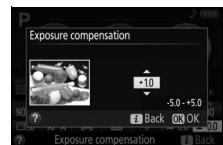

Location Data

Embedding Location Data in Photos and Movies

The built-in location data unit can record information on the camera's current position (latitude, longitude, altitude) and the current time (UTC) as provided by satellite navigation systems and embed it in photographs and movies taken with the camera. The location data function works best in locations that offer an unobstructed view of the sky.

1 Select Location data.

Press the **MENU** button to display the menus, then highlight **Location data** in the setup menu and press **▶**.

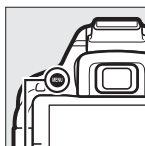

MENU button

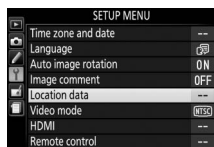

2 Select Record location data.

Highlight **Record location data** and press **▶**.

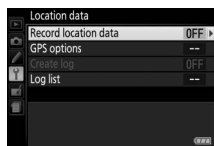

3 Select On.

Highlight **On** and press **OK** to enable the camera's built-in location data unit. The camera will begin receiving location data from navigation satellites.

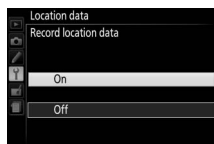

Before Enabling the Location Data Function

Before using the location data function, read the warnings on pages vi to xiii and make sure that the clock is set to the correct time and date in **Time zone and date** (p 55). To prevent the camera turning off unexpectedly, make sure the battery is charged.

4 Check satellite signal strength.

Press the **info** button and check satellite signal strength in the information display.

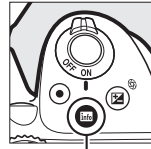

info button



5 Take pictures.

The location data obtained via the navigation satellite system will be recorded with each photograph or movie taken and can be viewed in the playback photo info displays or plotted on a map using the supplied ViewNX 2 software (62).

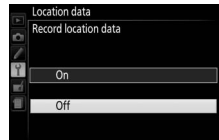

6 Turn the location data function off.

To turn the location data function off when it is no longer needed, select **Off** for **Location data** > **Record location data** in the setup menu.



The Satellite Signal Indicator

Signal strength is shown in the location data display as follows:

-  (static): Camera records latitude, longitude, and altitude.
-  (static): Camera records latitude and longitude only; altitude is not recorded.
-  (flashing): Location not recorded.

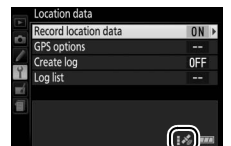

Location Data

Local geographic and atmospheric conditions may prevent or delay the acquisition of location data. The camera may be unable to receive location data indoors, underground, or in metal containers or the vicinity of bridges and other large structures, trees, power lines, or other objects that block or reflect satellite signals. Pay attention to your footing and surroundings when looking for locations with good reception. The positions of navigation satellites are continuously changing, preventing or delaying the acquisition of location data at certain hours of the day. The presence of cellular telephones or other devices that transmit on frequencies close to those of navigation satellites may also interfere with the acquisition of location data.

Note that in some cases the camera may take some time to acquire a signal, for example immediately after the battery is inserted or when the record location data function is enabled for the first time, or after an extended period of disuse. Location data for movies are for the start of recording. Note that turning the camera off does not disable the location data function.

Depending on the accuracy of the data acquired from the satellite system and the effects of local topography on satellite reception, the location data recorded with pictures may differ from the actual location by up to several hundred meters.

Wi-Fi

What Wi-Fi Can Do for You

Install the Wireless Mobile Utility app on your Android and iOS device to display the view through the camera lens on the smart device, take pictures and control the camera remotely, and download pictures from the camera for sharing via the Internet.

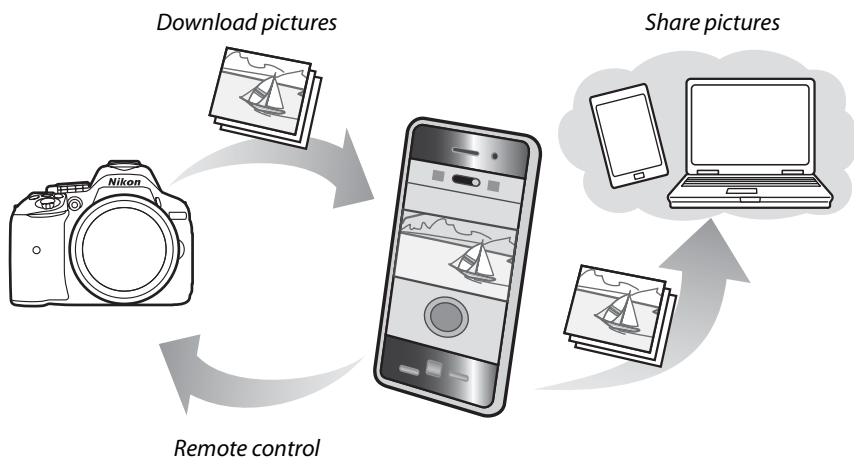

See the Wireless Mobile Utility manual for details (📖 49).

Accessing the Camera

Before connecting via Wi-Fi (wireless LAN), install the Wireless Mobile Utility on your Android or iOS smart device. Instructions for accessing the camera vary with the type of connection used by the smart device.

Android

- **Push-button WPS:** If the smart device supports push-button WPS (i.e., has a **WPS button connection** option in its **Wi-Fi settings** menu), you can use this easy method to connect to the smart device (□ 50).
- **PIN-entry WPS:** If the smart device supports WPS, you can use the camera to establish a connection by entering the PIN displayed by the smart device (□ 51).
- **View SSID:** If the smart device does not support WPS, you can connect by selecting the camera SSID on the smart device (□ 52).

iOS

- **View SSID:** Connect by selecting the camera SSID on the smart device (□ 52).

Installing the App

1 Find the app.

On the smart device, connect to the Google Play service, the App Store, or another app marketplace and search for “Wireless Mobile Utility”. For more information, see the instructions provided with the smart device.

2 Install the app.

Read the app description and install the app. A pdf manual for the Wireless Mobile Utility is available for download at the following URLs:

- **Android:** <http://nikonimglib.com/ManDL/WMAU/>
- **iOS:** <http://nikonimglib.com/ManDL/WMAU-ios/>

WPS

WPS (Wi-Fi Protected Setup) is a standard designed to make it easy to establish a secure wireless network. For information on the steps involved and the length of time the smart device will wait for a connection, see the documentation supplied with the smart device.

WPS (Android Only)

1 Enable the camera's built-in Wi-Fi.

Press the **MENU** button to display the menus, then highlight **Wi-Fi** in the setup menu and press **▶**. Highlight **Network connection** and press **▶**, then highlight **Enable** and press **⊗**. Wait a few seconds for Wi-Fi to activate.

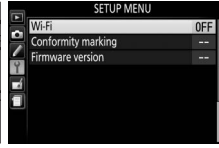

MENU button

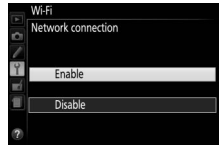

2 Connect.

Enable WPS button connections on the camera and smart device:

- **Camera:** Highlight **Network settings** and press **▶**.

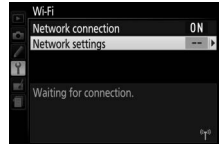

Highlight **Push-button WPS** and press **▶** to ready the camera for a WPS connection. The camera will wait about two minutes for a WPS connection request from the smart device. To extend the wait time, press **⊗**.

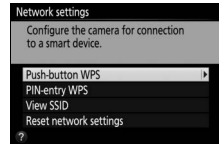

- **Smart device:** Select **Wi-Fi settings > WPS button connection**.

3 Launch the Wireless Mobile Utility.

Launch the Wireless Mobile Utility on the smart device. The main dialog will be displayed.

PIN Entry (Android Only)

- 1 Enable the camera's built-in Wi-Fi.**

Press the **MENU** button to display the menus, then highlight **Wi-Fi** in the setup menu and press **▶**. Highlight **Network connection** and press **▶**, then highlight **Enable** and press **Ⓞ**. Wait a few seconds for Wi-Fi to activate.

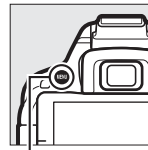

MENU button

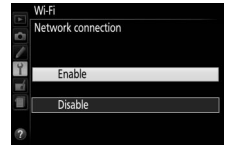
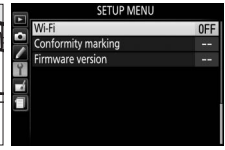

- 2 Select Network settings > PIN-entry WPS.**

Highlight **Network settings** and press **▶**.



Highlight **PIN-entry WPS** and press **▶**.

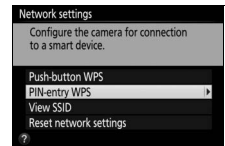
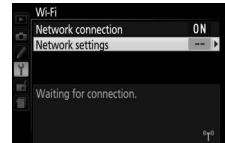

- 3 Enter the PIN.**

Enter the PIN displayed by the smart device. Press **◀** or **▶** to highlight digits and press **▲** or **▼** to change. Press **Ⓞ** when entry is complete.

- 4 Launch the Wireless Mobile Utility.**

Launch the Wireless Mobile Utility on the smart device. The main dialog will be displayed.

SSID (Android and iOS)

1 Enable the camera's built-in Wi-Fi.

Press the **MENU** button to display the menus, then highlight **Wi-Fi** in the setup menu and press **▶**. Highlight **Network connection** and press **▶**, then highlight **Enable** and press **OK**. Wait a few seconds for Wi-Fi to activate.



MENU button

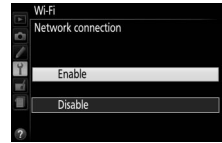

2 Display the camera SSID.

Highlight **Network settings** and press **▶**.



Highlight **View SSID** and press **▶**.

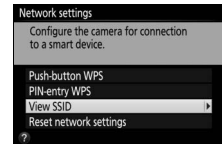
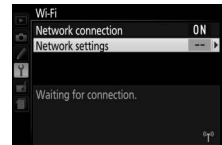

3 Select the camera SSID.

Select the camera SSID in the list of networks displayed by the smart device.

4 Launch the Wireless Mobile Utility.

Launch the Wireless Mobile Utility on the smart device. The main dialog will be displayed.

■ Terminating the Connection

Wi-Fi can be disabled by:

- Selecting **Wi-Fi > Network connection > Disable** in the camera setup menu
- Starting movie recording
- Turning the camera off

■ Restoring Default Settings

To restore default network settings, select **Wi-Fi > Network settings > Reset network settings**. A confirmation dialog will be displayed; highlight **Yes** and press **OK** to restore default network settings.

The Wi-Fi Display

While Wi-Fi is enabled, a  icon will flash in the information display. The icon will stop flashing once a connection has been established and the camera is exchanging data with the smart device.



Wi-Fi

Read the warnings on pages xiv to xvi before using the Wi-Fi function. To disable Wi-Fi in settings in which its use is prohibited, select **Wi-Fi > Network connection > Disable** in the camera setup menu. Note that Eye-Fi cards can not be used while Wi-Fi is enabled and that the standby timer will not turn off while the Wireless Mobile Utility app on the smart device is communicating with the camera. If no data are exchanged for about 5 minutes, the standby timer will turn off. The camera Wi-Fi function is only available when a memory card is inserted and can not be used when a USB or HDMI cable is connected. To prevent loss of power while connected, charge the battery before enabling the network connection.

Camera Menu

Most shooting, playback, and setup options can be accessed from the camera menu. To view the menu, press the **MENU** button.

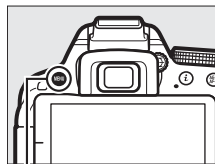

MENU button

Tabs

Choose from the following menus:

- : Playback
- : Shooting
- : Custom Settings
- : Setup
- : Retouch
- : Recent settings or My Menu (defaults to Recent settings;

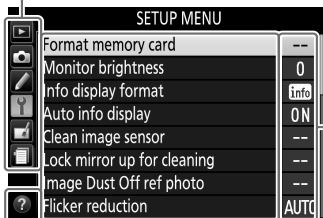

Current settings are shown by icons.

Menu options

Options in current menu.



A description of the currently selected option or menu can be displayed by pressing the (?) button. Press or to scroll through the display. Press (?) again to return to the menus.

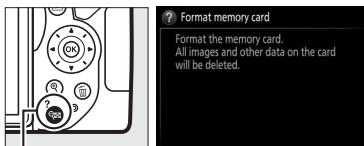

(?) button

Menu Options

▶ *Playback Menu: Managing Images*

Delete	Image review	DPOF print order
Playback folder	Rotate tall	Rating
Playback display options	Slide show	Select to send to smart device

📷 *Shooting Menu: Shooting Options*

Reset shooting menu	Manage Picture Control	ISO sensitivity settings
Storage folder	Auto distortion control	Release mode
Image quality	Color space	Multiple exposure
Image size	Active D-Lighting	Interval timer shooting
NEF (RAW) recording	HDR (high dynamic range)	Optical VR *
White balance	Long exposure NR	Movie settings
Set Picture Control	High ISO NR	

* Available only with lenses that support this item.

🔧 *Custom Settings: Fine-Tuning Camera Settings*

Reset custom settings	c2 Auto off timers	e Bracketing/flash
a Autofocus	c3 Self-timer	e1 Flash cntl for built-in flash
a1 AF-C priority selection	c4 Remote on duration(ML-L3)	e2 Auto bracketing set
a2 Number of focus points	d Shooting/display	f Controls
a3 Built-in AF-assist illuminator	d1 Beep	f1 Assign Fn button
a4 Rangefinder	d2 Viewfinder grid display	f2 Assign AE-L/AF-L button
b Exposure	d3 ISO display	f3 Reverse dial rotation
b1 EV steps for exposure cntl	d4 File number sequence	f4 Slot empty release lock
c Timers/AE lock	d5 Exposure delay mode	f5 Reverse indicators
c1 Shutter-release button AE-L	d6 Print date	

🔧 *Setup Menu: Camera Setup*

Format memory card	Flicker reduction	HDMI
Monitor brightness	Time zone and date	Remote control
Info display format	Language	Wi-Fi
Auto info display	Auto image rotation	Eye-Fi upload *
Clean image sensor	Image comment	Conformity marking
Lock mirror up for cleaning	Location data	Firmware version
Image Dust Off ref photo	Video mode	

* Only available when compatible Eye-Fi memory card is inserted.

Retouch Menu: Creating Retouched Copies

D-Lighting

Red-eye correction

Trim

Monochrome

Filter effects

Color balance

Image overlay

NEF (RAW) processing

Resize

Quick retouch

Straighten

Distortion control

Fisheye

Color outline

Color sketch

Perspective control

Miniature effect

Selective color

Edit movie

Side-by-side comparison*

* Available only if retouch menu is displayed by pressing **z** and selecting **Retouch** in full-frame playback when a retouched image or original is displayed.

Recent Settings / **My Menu (Defaults to Recent Settings)**

For More Information

Information on individual menu options is available using the camera's on-board help ( 54).

Using Camera Menus

The multi selector and **OK** button are used to navigate the camera menus.

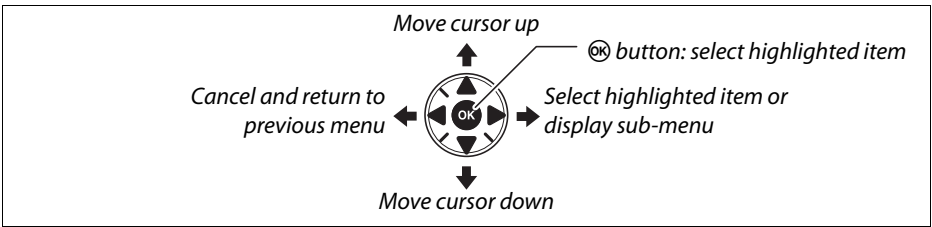

Follow the steps below to navigate the menus.

1 Display the menus.

Press the **MENU** button to display the menus.

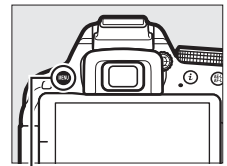

MENU button

2 Highlight the icon for the current menu.

Press **◀** to highlight the icon for the current menu.

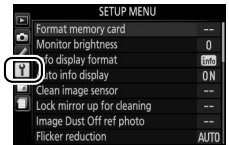

3 Select a menu.

Press **▲** or **▼** to select the desired menu.

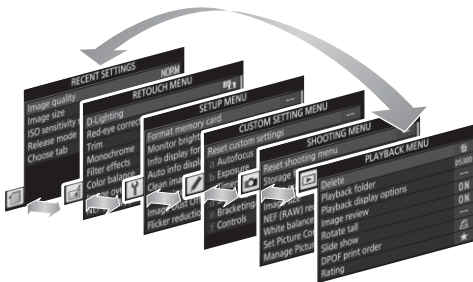
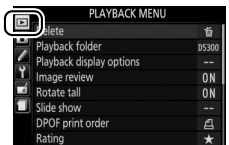

4 Position the cursor in the selected menu.

Press ► to position the cursor in the selected menu.

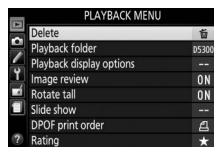

5 Highlight a menu item.

Press ▲ or ▼ to highlight a menu item.

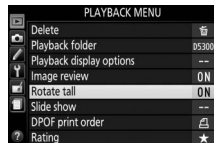

6 Display options.

Press ► to display options for the selected menu item.

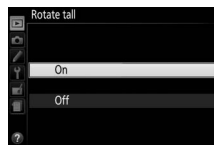

7 Highlight an option.

Press ▲ or ▼ to highlight an option.

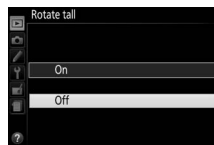

8 Select the highlighted item.

Press **OK** to select the highlighted item. To exit without making a selection, press the **MENU** button.



Note the following:

- Menu items that are displayed in gray are not currently available.
- While pressing ► generally has the same effect as pressing **OK**, there are some cases in which selection can only be made by pressing **OK**.
- To exit the menus and return to shooting mode, press the shutter-release button halfway (□ 19).

ViewNX 2

Installing ViewNX 2

Install the supplied software to display and edit photographs and movies that have been copied to your computer. Before installing ViewNX 2, confirm that your computer meets the system requirements on page 60. Be sure to use the latest version of ViewNX 2, which is available for download from the websites listed on page xii, as earlier versions that do not support the D5300 may fail to transfer NEF (RAW) images correctly.



1 Launch the installer.

Start the computer, insert the installer CD, and launch the installer. A language selection dialog will be displayed. If the desired language is not available, click **Region Selection** to choose a different region (region selection is not available in the European release).

① Select region (if required)

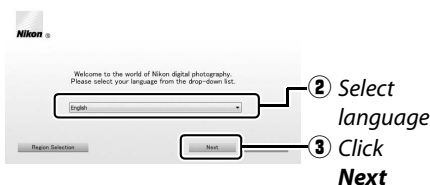

2 Start the installer.

Click **Install** and follow the on-screen instructions.



Click Install

3 Exit the installer.



4 Remove the installer CD from the CD-ROM drive.

✍ System Requirements		
	Windows	Mac OS
CPU	<ul style="list-style-type: none"> • Photos: Intel Celeron, Pentium 4, Core Series; 1.6 GHz or better • Movies (playback): 3.0 GHz or better Pentium D; Intel Core i5 or better recommended when viewing movies with a frame size of 1280×720 or more at a frame rate of 30 fps or above or movies with a frame size of 1920×1080 or more • Movies (editing): Intel Core i5 or better 	<ul style="list-style-type: none"> • Photos: Intel Core or Xeon series • Movies (playback): Core Duo 2 GHz or better; Intel Core i5 or better recommended when viewing movies with a frame size of 1280×720 or more at a frame rate of 30 fps or above or movies with a frame size of 1920×1080 or more • Movies (editing): Intel Core i5 or better
OS	Pre-installed versions of Windows 8, Windows 7, Windows Vista, and Windows XP; note that 64-bit versions of Windows XP are not supported	OS X 10.8 or 10.7, Mac OS X 10.6
Memory (RAM)	<ul style="list-style-type: none"> • 32-bit Windows 8, Windows 7, or Windows Vista: 1 GB or more (2 GB or more recommended) • 64-bit Windows 8, Windows 7, or Windows Vista: 2 GB or more (4 GB or more recommended) • Windows XP: 512 MB or more (2 GB or more recommended) 	<ul style="list-style-type: none"> • OS X 10.8, 10.7: 2 GB or more (4 GB or more recommended) • Mac OS X 10.6: 1 GB or more (4 GB or more recommended)
Hard disk space	A minimum of 1 GB available on the startup disk (3 GB or more recommended)	
Graphics	Resolution: 1024×768 pixels (XGA) or more (1280×1024 pixels or more recommended) Color: 24-bit color (True Color) or more	Resolution: 1024×768 pixels (XGA) or more (1280×1024 pixels or more recommended) Color: 24-bit color (millions of colors) or more
See the websites listed on page xii for the latest information on supported operating systems.		

Using ViewNX 2

Copy Pictures to the Computer

Before proceeding, be sure you have installed the software on the supplied ViewNX 2 CD (☞ 59).

1 Connect the USB cable.

After turning the camera off and ensuring that a memory card is inserted, connect the supplied USB cable as shown and then turn the camera on.

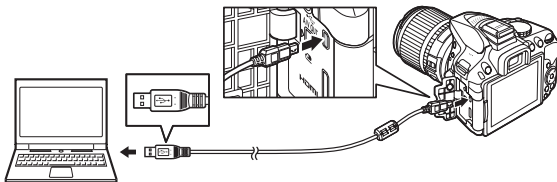

2 Start Nikon Transfer 2 component of ViewNX 2.

If a message is displayed prompting you to choose a program, select Nikon Transfer 2.

Windows 7

If the following dialog is displayed, select Nikon Transfer 2 as described below.

1 Under **Import pictures and videos**, click **Change program**. A program selection dialog will be displayed; select **Import File using Nikon Transfer 2** and click **OK**.

2 Double-click **Import File**.



3 Click Start Transfer.

At default settings, pictures on the memory card will be copied to the computer.

During Transfer

Do not turn the camera off or disconnect the USB cable while transfer is in progress.



Start Transfer

4 Terminate the connection.

When transfer is complete, turn the camera off and disconnect the USB cable.

View Pictures

Pictures are displayed in ViewNX 2 when transfer is complete.

Starting ViewNX 2 Manually

- Windows: Double-click the ViewNX 2 shortcut on the desktop.
- Mac OS: Click the ViewNX 2 icon in the Dock.

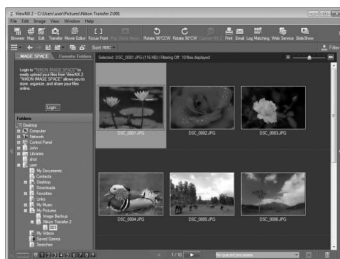

Retouching Photographs

To crop pictures and perform such tasks as adjusting sharpness and tone levels, click the **Edit** button in the ViewNX 2 toolbar.

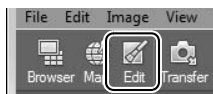

Editing Movies

To perform such tasks as trimming unwanted footage from movies shot with the camera, click the **Movie Editor** button in the ViewNX 2 toolbar.



Printing Pictures

Click the **Print** button in the ViewNX 2 toolbar. A dialog will be displayed, allowing you to print pictures on a printer connected to the computer.

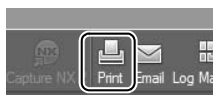

Viewing Location Data

To view the locations where pictures were taken or display track logs, click the **Map** button in the ViewNX 2 toolbar.

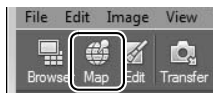

For More Information

Consult online help for more information on using ViewNX 2.

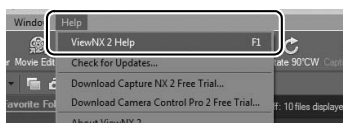

Viewing the Nikon Website

To visit the Nikon website after installing ViewNX 2, select **All Programs > Link to Nikon** from the Windows start menu (Internet connection required).

Technical Notes

Read this chapter for information on compatible accessories, cleaning and storing the camera, and what to do if an error message is displayed or you encounter problems using the camera.

Compatible Lenses

This camera supports autofocus with AF-S, AF-P, and AF-I CPU lenses only. AF-S lenses have names beginning with **AF-S**, AF-P lenses with **AF-P**, and AF-I lenses with **AF-I**. Autofocus is not supported with other autofocus (AF) lenses. The following table lists the features available with compatible lenses in viewfinder photography:

Camera setting Lens/accessory	Focus				Mode		Metering		
	AF	MF (with electronic rangefinder)	MF	M	Other modes	3D	Color	☒	
AF-S, AF-P, AF-I NIKKOR	✓	✓	✓	✓	✓	✓	—	✓ ¹	
Other type G or D AF NIKKOR	—	✓	✓	✓	✓	✓	—	✓ ¹	
PC-E NIKKOR series ^{2,3}	—	✓ ⁴	✓	✓	✓	✓	—	✓ ¹	
PC Micro 85mm f/2.8D ⁵	—	✓ ⁴	✓	✓	—	✓	—	✓ ¹	
AF-S/AF-I teleconverter	✓ ⁶	✓ ⁶	✓	✓	✓	✓	—	✓ ¹	
Other AF NIKKOR (except lenses for F3AF)	—	✓ ⁷	✓	✓	✓	—	✓	✓ ¹	
AI-P NIKKOR	—	✓ ⁸	✓	✓	✓	—	✓	✓ ¹	

- 1 Spot metering meters selected focus point.
 - 2 Observe due caution when tilting or shifting PC-E NIKKOR 24mm f/3.5D ED lenses, as they may contact the camera body and cause damage or injury.
 - 3 Shifting and/or tilting the lens interferes with exposure.
 - 4 Can not be used with shifting or tilting.
 - 5 Optimal exposure will only be achieved if the lens is at maximum aperture and the lens is not shifted or tilted.
 - 6 With maximum effective aperture of f/5.6 or faster.
 - 7 When AF 80–200mm f/2.8, AF 35–70mm f/2.8, AF 28–85mm f/3.5–4.5 (New), or AF 28–85mm f/3.5–4.5 lenses are zoomed all the way in at the minimum focus distance, the in-focus indicator (●) may be displayed when the image on the matte screen in the viewfinder is not in focus. Before shooting, confirm that the image in the viewfinder screen is in focus.
 - 8 With maximum aperture of f/5.6 or faster.
- Noise in the form of lines may appear during autofocus when movies are recorded at high ISO sensitivities. Use manual focus or focus lock.

✓ IX NIKKOR Lenses

IX NIKKOR lenses can not be used.

Other Accessories

At the time of writing, the following accessories were available for the D5300.

Power sources	<ul style="list-style-type: none">• Rechargeable Li-ion Battery EN-EL14a (□ 9): Additional EN-EL14a batteries are available from local retailers and Nikon-authorized service representatives. EN-EL14 batteries can also be used.• Battery Charger MH-24 (□ 9): Recharge EN-EL14a and EN-EL14 batteries.• Power Connector EP-5A, AC Adapter EH-5b: These accessories can be used to power the camera for extended periods (EH-5a and EH-5 AC adapters can also be used). A power connector EP-5A is required to connect the camera to the EH-5b, EH-5a, or EH-5.
Filters	<ul style="list-style-type: none">• Filters intended for special-effects photography may interfere with autofocus or the electronic rangefinder.• The D5300 can not be used with linear polarizing filters. Use C-PL or C-PL II circular polarizing filters instead.• NC filters are recommended for protecting the lens.• To prevent ghosting, use of a filter is not recommended when the subject is framed against a bright light, or when a bright light source is in the frame.• Center-weighted metering is recommended with filters with exposure factors (filter factors) over $1 \times$ (Y44, Y48, Y52, O56, R60, X0, X1, C-PL, ND2S, ND4, ND4S, ND8, ND8S, ND400, A2, A12, B2, B8, B12). See the filter manual for details.
Viewfinder eyepiece accessories	<ul style="list-style-type: none">• DK-20C Eyepiece Correction Lenses: Lenses are available with diopters of -5, -4, -3, -2, 0, $+0.5$, $+1$, $+2$, and $+3 \text{ m}^{-1}$ when the camera diopter adjustment control is in the neutral position (-1 m^{-1}). Use eyepiece correction lenses only if the desired focus can not be achieved with the built in diopter adjustment control (-1.7 to $+1.0 \text{ m}^{-1}$). Test eyepiece correction lenses before purchase to ensure that the desired focus can be achieved. The rubber eyecup can not be used with eyepiece correction lenses.• Magnifier DG-2: The DG-2 magnifies the scene displayed in the center of the viewfinder for greater precision during focusing. Eyepiece adapter required (available separately).• Eyepiece Adapter DK-22: The DK-22 is used when attaching the DG-2 magnifier. The monitor can not be rotated with the adapter in place.• Right-Angle Viewing Attachment DR-6: The DR-6 attaches at a right angle to the viewfinder eyepiece, allowing the image in the viewfinder to be viewed at right angles to the lens (for example, from directly above when the camera is horizontal). The monitor can not be rotated with the attachment in place.
Software	<ul style="list-style-type: none">• Capture NX 2: A complete photo editing package offering such features as white balance adjustment and color control points.• Camera Control Pro 2: Control the camera remotely from a computer to record movies and photographs and save photographs directly to the computer hard disk. <p>Note: Use the latest versions of Nikon software. Most Nikon software offers an auto update feature (Nikon Message Center 2) when the computer is connected to the Internet. See the websites listed on page xii for the latest information on supported operating systems.</p>

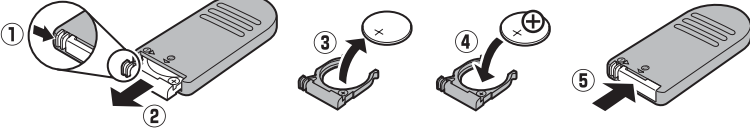
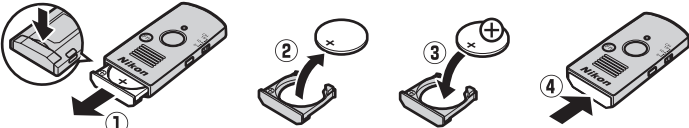
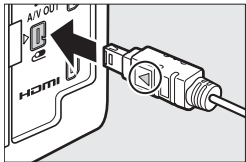
Body cap	Body Cap BF-1B/Body Cap BF-1A: The body cap keeps the mirror, viewfinder screen, and image sensor free of dust when a lens is not in place.
Remote controls/wireless remote controller	<ul style="list-style-type: none"> Wireless Remote Control ML-L3 (☐ 4): The ML-L3 uses a 3 V CR2025 battery.  <p>Pressing the battery-chamber latch to the right (①), insert a fingernail into the gap and open the battery chamber (②). Ensure that the battery is inserted in the correct orientation (④).</p> <ul style="list-style-type: none"> Wireless Remote Controller WR-R10*/WR-T10: When a WR-R10 wireless remote controller is attached, the camera can be controlled wirelessly using a WR-T10 wireless remote controller. The WR-T10 uses a 3 V CR2032 battery.  <p>Insert a fingernail into the gap behind the battery-chamber latch and open the battery chamber (①). Ensure that the battery is inserted in the correct orientation (③).</p> <ul style="list-style-type: none"> Wireless Remote Controller WR-1: WR-1 units are used in groups of two or more, with one functioning as a transmitter and the remaining units acting as receivers. The receivers are attached to the accessory terminals of one or more cameras, allowing the transmitter to be used to release the camera shutters.
	Microphones
Accessory terminal accessories	<p>The D5300 is equipped with an accessory terminal for WR-1 and WR-R10 wireless remote controllers, MC-DC2 remote cords, and GP-1/GP-1A GPS units, which connect with the ◀ mark on the connector aligned with the ▶ next to the accessory terminal (close the connector cover when the terminal is not in use).</p> 
USB and A/V connector accessories	<ul style="list-style-type: none"> UC-E17 and UC-E6 USB cables (☐ 61): The supplied UC-E17 cable is not available for separate purchase; purchase UC-E6 cables instead. EG-CP16 audio/video cables

* A wireless remote controller can not be attached at the same time as an ME-1 stereo microphone. Attempting to forcibly attach accessories can damage the camera or accessory.

Optional Accessories

Availability may vary with country or region. See our website or brochures for the latest information.

Approved Memory Cards

The camera supports SD, SDHC, and SDXC memory cards, including SDHC and SDXC cards compliant with UHS-I. Cards rated SD Speed Class 6 or better are recommended for movie recording; using slower cards may result in recording being interrupted. When choosing cards for use in card readers, be sure they are compatible with the device. Contact the manufacturer for information on features, operation, and limitations on use.



Caring for the Camera

Storage

When the camera will not be used for an extended period, remove the battery and store it in a cool, dry area with the terminal cover in place. To prevent mold or mildew, store the camera in a dry, well-ventilated area. Do not store your camera with naphtha or camphor moth balls or in locations that:

- are poorly ventilated or subject to humidities of over 60%
- are next to equipment that produces strong electromagnetic fields, such as televisions or radios
- are exposed to temperatures above 50 °C (122 °F) or below –10 °C (14 °F)

Cleaning

Camera body	Use a blower to remove dust and lint, then wipe gently with a soft, dry cloth. After using the camera at the beach or seaside, wipe off sand or salt with a cloth lightly dampened in distilled water and dry thoroughly. Important: <i>Dust or other foreign matter inside the camera may cause damage not covered under warranty.</i>
Lens, mirror, and viewfinder	These glass elements are easily damaged. Remove dust and lint with a blower. If using an aerosol blower, keep the can vertical to prevent the discharge of liquid. To remove fingerprints and other stains, apply a small amount of lens cleaner to a soft cloth and clean with care.
Monitor	Remove dust and lint with a blower. When removing fingerprints and other stains, wipe the surface lightly with a soft cloth or chamois leather. Do not apply pressure, as this could result in damage or malfunction.

Do not use alcohol, thinner, or other volatile chemicals.

Servicing the Camera and Accessories

The camera is a precision device and requires regular servicing. Nikon recommends that the camera be inspected by the original retailer or Nikon-authorized service representative once every one to two years, and that it be serviced once every three to five years (note that fees apply to these services). Frequent inspection and servicing are particularly recommended if the camera is used professionally. Any accessories regularly used with the camera, such as lenses or optional flash units, should be included when the camera is inspected or serviced.

Caring for the Camera and Battery: Cautions

Caring for the Camera

Do not drop: The product may malfunction if subjected to strong shocks or vibration.

Keep dry: This product is not waterproof, and may malfunction if immersed in water or exposed to high levels of humidity. Rusting of the internal mechanism can cause irreparable damage.

Avoid sudden changes in temperature: Sudden changes in temperature, such as those that occur when entering or leaving a heated building on a cold day, can cause condensation inside the device. To prevent condensation, place the device in a carrying case or plastic bag before exposing it to sudden changes in temperature.

Keep away from strong magnetic fields: Do not use or store this device in the vicinity of equipment that generates strong electromagnetic radiation or magnetic fields. Strong static charges or the magnetic fields produced by equipment such as radio transmitters could interfere with the monitor, damage data stored on the memory card, or affect the product's internal circuitry.

Do not leave the lens pointed at the sun: Do not leave the lens pointed at the sun or other strong light source for an extended period. Intense light may cause the image sensor to deteriorate or produce a white blur effect in photographs.

Turn the product off before removing or disconnecting the power source: Do not unplug the product or remove the battery while the product is on or while images are being recorded or deleted. Forcibly cutting power in these circumstances could result in loss of data or in damage to product memory or internal circuitry. To prevent an accidental interruption of power, avoid carrying the product from one location to another while the AC adapter is connected.

Cleaning: When cleaning the camera body, use a blower to gently remove dust and lint, then wipe gently with a soft, dry cloth. After using the camera at the beach or seaside, wipe off any sand or salt using a cloth lightly dampened in pure water and then dry the camera thoroughly.

The lens and mirror are easily damaged. Dust and lint should be gently removed with a blower. When using an aerosol blower, keep the can vertical to prevent discharge of liquid. To remove fingerprints and other stains from the lens, apply a small amount of lens cleaner to a soft cloth and wipe the lens carefully.

See the *Reference Manual* for information on cleaning the image sensor.

Do not touch the shutter curtain: The shutter curtain is extremely thin and easily damaged. Under no circumstances should you exert pressure on the curtain, poke it with cleaning tools, or subject it to powerful air currents from a blower. These actions could scratch, deform, or tear the curtain.

Storage: To prevent mold or mildew, store the camera in a dry, well-ventilated area. If you are using an AC adapter, unplug the adapter to prevent fire. If the product will not be used for an extended period, remove the battery to prevent leakage and store the camera in a plastic bag containing a desiccant. Do not, however, store the camera case in a plastic bag, as this may cause the material to deteriorate. Note that desiccant gradually loses its capacity to absorb moisture and should be replaced at regular intervals.

To prevent mold or mildew, take the camera out of storage at least once a month. Turn the camera on and release the shutter a few times before putting it away.

Store the battery in a cool, dry place. Replace the terminal cover before putting the battery away.

Notes on the monitor: The monitor is constructed with extremely high precision; at least 99.99% of pixels are effective, with no more than 0.01% being missing or defective. Hence while these displays may contain pixels that are always lit (white, red, blue, or green) or always off (black), this is not a malfunction and has no effect on images recorded with the device.

Images in the monitor may be difficult to see in a bright light.

Do not apply pressure to the monitor, as this could cause damage or malfunction. Dust or lint on the monitor can be removed with a blower. Stains can be removed by wiping lightly with a soft cloth or chamois leather. Should the monitor break, care should be taken to avoid injury from broken glass and to prevent liquid crystal from the monitor touching the skin or entering the eyes and mouth.

Moiré: Moiré is an interference pattern created by the interaction of an image containing a regular, repeating grid, such as the pattern of weave in cloth or windows in a building, with the camera image sensor grid. If you notice moiré in your photographs, try changing the distance to the subject, zooming in and out, or changing the angle between the subject and the camera.

Caring for the Battery

Batteries may leak or explode if improperly handled. Observe the following precautions when handling batteries:



- Use only batteries approved for use in this equipment.
- Do not expose the battery to flame or excessive heat.
- Keep the battery terminals clean.
- Turn the product off before replacing the battery.
- Remove the battery from the camera or charger when not in use and replace the terminal cover. These devices draw minute amounts of charge even when off and could draw the battery down to the point that it will no longer function. If the battery will not be used for some time, insert it in the camera and run it flat before removing it and storing it in a location with an ambient temperature of 15 °C to 25 °C (59 °F to 77 °F; avoid hot or extremely cold locations). Repeat this process at least once every six months.
- Turning the camera on and off repeatedly when the battery is fully discharged will shorten battery life. Batteries that have been fully discharged must be charged before use.





- The internal temperature of the battery may rise while the battery is in use. Attempting to charge the battery while the internal temperature is elevated will impair battery performance, and the battery may not charge or charge only partially. Wait for the battery to cool before charging.
- Continuing to charge the battery after it is fully charged can impair battery performance.
- A marked drop in the time a fully charged battery retains its charge when used at room temperature indicates that it requires replacement. Purchase a new EN-EL14a battery.
- Charge the battery before use. When taking photographs on important occasions, ready a spare EN-EL14a battery and keep it fully charged. Depending on your location, it may be difficult to purchase replacement batteries on short notice. Note that on cold days, the capacity of batteries tends to decrease. Be sure the battery is fully charged before taking photographs outside in cold weather. Keep a spare battery in a warm place and exchange the two as necessary. Once warmed, a cold battery may recover some of its charge.
- Used batteries are a valuable resource; recycle in accord with local regulations.

Error Messages

This section lists the indicators and error messages that appear in the viewfinder and monitor.

Warning Icons

A flashing  in the monitor or  in the viewfinder indicates that a warning or error message can be displayed in the monitor by pressing the  (?) button.

Indicator		Solution
Monitor	Viewfinder	
Lock lens aperture ring at minimum aperture (largest f-number).	 (flashes)	Set lens aperture ring to minimum aperture (highest f-number).
Lens not attached	 (flashes)	<ul style="list-style-type: none"> • Attach non-IX NIKKOR lens. • If non-CPU lens is attached, select mode M.
Before taking photos, rotate the zoom ring to extend the lens.	 (flashes)	A lens with a retractable lens barrel button is attached with the lens barrel retracted. Press the retractable lens barrel button and rotate the zoom ring to extend the lens.
Shutter release disabled. Recharge battery.	 (flashes)	Turn camera off and recharge or replace battery.
This battery cannot be used. Choose battery designated for use in this camera.	 (flashes)	Use Nikon-approved battery.
Initialization error. Turn camera off and then on again.	 / (E r r r) (flashes)	Turn camera off, remove and replace battery, and then turn camera on again.
Battery level is low. Complete operation and turn camera off immediately.	—	End cleaning and turn camera off and recharge or replace battery.
Clock not set	—	Set camera clock.
No SD card inserted	(- E -) / (E r r r) (flashes)	Turn camera off and confirm that card is correctly inserted.
Memory card is locked. Slide lock to “write” position.	 (flashes)	Memory card is locked (write protected). Slide card write-protect switch to “write” position.
This memory card cannot be used. Card may be damaged. Insert another card.	 / (E r r r) (flashes)	<ul style="list-style-type: none"> • Use approved card. • Format card. If problem persists, card may be damaged. Contact Nikon-authorized service representative. • Error creating new folder. Delete files or insert new memory card. • Insert new memory card.

Indicator		Solution
Monitor	Viewfinder	
This card is not formatted. Format the card.	(F or) (flashes)	Format card or turn camera off and insert new memory card.
Card is full	FuL/G/? (flashes)	<ul style="list-style-type: none"> • Reduce quality or size. • Delete photographs. • Insert new memory card.
—	● (flashes)	Camera can not focus using autofocus. Change composition or focus manually.
Subject is too bright	? (flashes)	<ul style="list-style-type: none"> • Use a lower ISO sensitivity. • Use commercial ND filter. • In mode: <ul style="list-style-type: none"> S Increase shutter speed A Choose a smaller aperture (higher f-number) ☒ Choose another shooting mode
Subject is too dark		<ul style="list-style-type: none"> • Use a higher ISO sensitivity. • Use flash. • In mode: <ul style="list-style-type: none"> S Lower shutter speed A Choose a larger aperture (lower f-number)
No “Bulb” in S mode	b u l b (flashes)	Change shutter speed or select mode M .
No “Time” in S mode	- - (flashes)	
—	⚡ (flashes)	Flash has fired at full power. Check photo in monitor; if underexposed, adjust settings and try again.
—	⚡/? (flashes)	<ul style="list-style-type: none"> • Use the flash. • Change distance to subject, aperture, flash range, or ISO sensitivity. • Lens focal length is less than 18 mm: use a longer focal length.

Indicator		Solution
Monitor	Viewfinder	
Error. Press shutter release button again.	Err (flashes)	Release shutter. If error persists or appears frequently, consult Nikon-authorized service representative.
Start-up error. Contact a Nikon-authorized service representative.		Consult Nikon-authorized service representative.
Metering error		
Unable to start live view. Please wait for camera to cool.	—	Wait for the internal circuits to cool before resuming live view or movie recording.
Folder contains no images.	—	Folder selected for playback contains no images (note that this message will be displayed if memory card is inserted after Current is selected for Playback folder in playback menu and playback started before any pictures are taken). Insert another memory card or select All for Playback folder .
Cannot display this file.	—	File can not be played back on camera.
Cannot select this file.	—	Images created with other devices can not be retouched.
Could not connect; multiple devices detected. Try again later.	—	Multiple smart devices are attempting to connect to camera simultaneously. Wait a few minutes before trying again.
Error	—	Select Disable for Wi-Fi > Network connection , then select Enable again.
Network access not available until camera cools.	—	Turn camera off and try again after waiting for camera to cool.



Specifications

■ ■ Nikon D5300 Digital Camera

Type	
Type	Single-lens reflex digital camera
Lens mount	Nikon F mount (with AF contacts)
Effective angle of view	Nikon DX format; focal length equivalent to approx. 1.5× that of lenses with FX format angle of view
Effective pixels	
Effective pixels	24.2 million
Image sensor	
Image sensor	23.5 × 15.6 mm CMOS sensor
Total pixels	24.78 million
Dust-reduction System	Image sensor cleaning, Image Dust Off reference data (optional Capture NX 2 software required)
Storage	
Image size (pixels)	<ul style="list-style-type: none">• 6000 × 4000 (Large)• 2992 × 2000 (Small)• 4496 × 3000 (Medium)
File format	<ul style="list-style-type: none">• NEF (RAW): 12- or 14 bit, compressed• JPEG: JPEG-Baseline compliant with fine (approx. 1 : 4), normal (approx. 1 : 8), or basic (approx. 1 : 16) compression• NEF (RAW)+JPEG: Single photograph recorded in both NEF (RAW) and JPEG formats
Picture Control System	Standard, Neutral, Vivid, Monochrome, Portrait, Landscape; selected Picture Control can be modified; storage for custom Picture Controls
Media	SD (Secure Digital) and UHS-I compliant SDHC and SDXC memory cards
File system	DCF (Design Rule for Camera File System) 2.0, DPOF (Digital Print Order Format), Exif (Exchangeable Image File Format for Digital Still Cameras) 2.3, PictBridge
Viewfinder	
Viewfinder	Eye-level pentamirror single-lens reflex viewfinder
Frame coverage	Approx. 95% horizontal and 95% vertical
Magnification	Approx. 0.82 × (50 mm f/1.4 lens at infinity, -1.0 m^{-1})
Eyepoint	18 mm (-1.0 m^{-1} ; from center surface of viewfinder eyepiece lens)
Diopter adjustment	$-1.7 - +1.0 \text{ m}^{-1}$
Focusing screen	Type B BriteView Clear Matte Mark VII screen
Reflex mirror	Quick return
Lens aperture	Instant return, electronically controlled

Lens	
Compatible lenses	Autofocus is available with AF-S, AF-P, and AF-I lenses. Autofocus is not available with other type G and D lenses, AF lenses (IX NIKKOR and lenses for the F3AF are not supported), and AI-P lenses. Non-CPU lenses can be used in mode M , but the camera exposure meter will not function. The electronic rangefinder can be used with lenses that have a maximum aperture of f/5.6 or faster.
Shutter	
Type	Electronically-controlled vertical-travel focal-plane shutter
Speed	$\frac{1}{4000}$ – 30 s in steps of $\frac{1}{3}$ or $\frac{1}{2}$ EV; Bulb; Time
Flash sync speed	$X = \frac{1}{200}$ s; synchronizes with shutter at $\frac{1}{200}$ s or slower
Release	
Release mode	[S] (single frame), [L] (continuous L), [H] (continuous H), [Q] (quiet shutter release), [T] (self-timer), [2s] (delayed remote; ML-L3), [Q] (quick-response remote; ML-L3); interval timer photography supported
Frame advance rate	<ul style="list-style-type: none"> [L]: Up to 3 fps [H]: Up to 5 fps (JPEG and 12-bit NEF/RAW) or 4 fps (14-bit NEF/RAW) Note: Frame rates assume continuous-servo AF, manual or shutter-priority auto exposure, a shutter speed of $\frac{1}{250}$ s or faster, Release selected for Custom Setting a1 (AF-C priority selection), and other settings at default values.
Self-timer	2 s, 5 s, 10 s, 20 s; 1–9 exposures
Exposure	
Metering mode	TTL exposure metering using 2016-pixel RGB sensor
Metering method	<ul style="list-style-type: none"> Matrix metering: 3D color matrix metering II (type G, E, and D lenses); color matrix metering II (other CPU lenses) Center-weighted metering: Weight of 75% given to 8-mm circle in center of frame Spot metering: Meters 3.5-mm circle (about 2.5% of frame) centered on selected focus point
Range (ISO 100, f/1.4 lens, 20 °C/68 °F)	<ul style="list-style-type: none"> Matrix or center-weighted metering: 0–20 EV Spot metering: 2–20 EV
Exposure meter coupling	CPU
Mode	Auto modes (AUTO auto; [A] auto, flash off); programmed auto with flexible program (P); shutter-priority auto (S); aperture-priority auto (A); manual (M); scene modes ([P] portrait; [L] landscape; [C] child; [S] sports; [M] close up; [N] night portrait; [NL] night landscape; [Pn] party/indoor; [B] beach/snow; [SUN] sunset; [DUSK] dusk/dawn; [PET] pet portrait; [C] candlelight; [BLOSSOM] blossom; [AUTUMN] autumn colors; [FOOD] food); special effects modes ([NV] night vision; [CS] color sketch; [TOY] toy camera effect; [MINI] miniature effect; [SC] selective color; [SILH] silhouette; [HIGH] high key; [LOW] low key; [HDP] HDR painting)
Exposure compensation	Can be adjusted by –5 – +5 EV in increments of $\frac{1}{3}$ or $\frac{1}{2}$ EV in P , S , A , and M modes
Bracketing	<ul style="list-style-type: none"> Exposure bracketing: 3 shots in steps of $\frac{1}{3}$ or $\frac{1}{2}$ EV White balance bracketing: 3 shots in steps of 1 Active D-Lighting bracketing: 2 shots
Exposure lock	Luminosity locked at detected value with $\frac{AE-L}{AF-L}$ (O-M) button

Exposure	
ISO sensitivity (Recommended Exposure Index)	ISO 100 – 12800 in steps of $\frac{1}{3}$ EV. Can also be set to approx. 0.3, 0.7, or 1 EV (ISO 25600 equivalent) above ISO 12800; auto ISO sensitivity control available
Active D-Lighting	☺ A Auto, ☺ H ⁺ Extra high, ☺ H High, ☺ N Normal, ☺ L Low, OFF Off
Focus	
Autofocus	Nikon Multi-CAM 4800DX autofocus sensor module with TTL phase detection, 39 focus points (including 9 cross-type sensor), and AF-assist illuminator (range approx. 0.5–3 m/1 ft 8 in.–9 ft 10 in.)
Detection range	–1 – +19 EV (ISO 100, 20 °C/68 °F)
Lens servo	<ul style="list-style-type: none"> • Autofocus (AF): Single-servo AF (AF-S); continuous-servo AF (AF-C); auto AF-S/AF-C selection (AF-A); predictive focus tracking activated automatically according to subject status • Manual focus (MF): Electronic rangefinder can be used
Focus point	Can be selected from 39 or 11 focus points
AF-area mode	Single-point AF, 9-, 21-, or 39- point dynamic-area AF, 3D-tracking, auto-area AF
Focus lock	Focus can be locked by pressing shutter-release button halfway (single-servo AF) or by pressing AE-L/AF-ON (O-) button
Flash	
Built-in flash	: Auto flash with auto pop-up P, S, A, M, \uparrow : Manual pop-up with button release
Guide Number	Approx. 12/39, 13/43 with manual flash (m/ft, ISO 100, 20 °C/68 °F)
Flash control	TTL: i-TTL flash control using 2016-pixel RGB sensor is available with built-in flash and SB-910, SB-900, SB-800, SB-700, SB-600, SB-400, or SB-300; i-TTL balanced fill-flash for digital SLR is used with matrix and center-weighted metering, standard i-TTL flash for digital SLR with spot metering
Flash mode	Auto, auto with red-eye reduction, auto slow sync, auto slow sync with red-eye reduction, fill-flash, red-eye reduction, slow sync, slow sync with red-eye reduction, rear-curtain with slow sync, rear-curtain sync, off
Flash compensation	–3 – +1 EV in increments of $\frac{1}{3}$ or $\frac{1}{2}$ EV
Flash-ready indicator	Lights when built-in flash or optional flash unit is fully charged; flashes after flash is fired at full output
Accessory shoe	ISO 518 hot-shoe with sync and data contacts and safety lock
Nikon Creative Lighting System (CLS)	Advanced Wireless Lighting supported with SB-910, SB-900, SB-800, or SB-700 as a master flash or SU-800 as commander; Flash Color Information Communication supported with all CLS-compatible flash units
Sync terminal	AS-15 sync terminal adapter (available separately)
White balance	
White balance	Auto, incandescent, fluorescent (7 types), direct sunlight, flash, cloudy, shade, preset manual, all except preset manual with fine-tuning.

Live view	
Lens servo	<ul style="list-style-type: none"> • Autofocus (AF): Single-servo AF (AF-S); full-time-servo AF (AF-F) • Manual focus (MF)
AF-area mode	Face-priority AF, wide-area AF, normal-area AF, subject-tracking AF
Autofocus	Contrast-detect AF anywhere in frame (camera selects focus point automatically when face-priority AF or subject-tracking AF is selected)
Automatic scene selection	Available in  and  modes
Movie	
Metering	TTL exposure metering using main image sensor
Metering method	Matrix
Frame size (pixels) and frame rate	<ul style="list-style-type: none"> • 1920 × 1080, 60p (progressive)/50p/30p/25p/24p, ★ high/normal • 1280 × 720, 60p/50p, ★ high/normal • 640 × 424, 30p/25p, ★ high/normal <p>Frame rates of 30p (actual frame rate 29.97 fps) and 60p (actual frame rate 59.94 fps) are available when NTSC is selected for video mode. 25p and 50p are available when PAL is selected for video mode. Actual frame rate when 24p is selected is 23.976 fps.</p>
File format	MOV
Video compression	H.264/MPEG-4 Advanced Video Coding
Audio recording format	Linear PCM
Audio recording device	Built-in or external stereo microphone; sensitivity adjustable
ISO sensitivity	ISO 100–12800; can also be set to approx. 0.3, 0.7, or 1 EV (ISO 25600 equivalent) above ISO 12800
Monitor	
Monitor	8.1 cm/3.2-in. (3 : 2), approx. 1037k-dot (720 × 480 × 3 = 1,036,800 dots), vari-angle TFT monitor with 170 ° viewing angle, approx. 100% frame coverage, and brightness adjustment
Playback	
Playback	Full-frame and thumbnail (4, 12, or 80 images or calendar) playback with playback zoom, movie playback, photo and/or movie slide shows, histogram display, highlights, auto image rotation, picture rating, and image comment (up to 36 characters)
Interface	
USB	Hi-Speed USB
Video output	NTSC, PAL
HDMI output	Type C mini-pin HDMI connector
Accessory terminal	Wireless remote controllers: WR-1, WR-R10 (available separately) Remote cords: MC-DC2 (available separately) GPS units: GP-1/GP-1A (available separately)
Audio input	Stereo mini-pin jack (3.5mm diameter); supports optional ME-1 stereo microphones

Wireless	
Standards	IEEE 802.11b, IEEE 802.11g
Communications protocols	<ul style="list-style-type: none"> • IEEE 802.11b: DSSS/CCK • IEEE 802.11g: OFDM
Operating frequency	2412–2462 MHz (channels 1–11)
Range (line of sight)	Approximately 30 m/98 ft (assumes no interference; range may vary with signal strength and presence or absence of obstacles)
Data rate	54 Mbps Maximum logical data rates according to IEEE standard. Actual rates may differ.
Security	<ul style="list-style-type: none"> • Authentication: Open system, WPA2-PSK • Encryption: AES
Wireless setup	Supports WPS
Access protocols	Infrastructure

Location data	
Receiving frequency	1575.42 MHz (C/A code)
Geodesics	WGS84

Supported languages	
Supported languages	Arabic, Bengali, Chinese (Simplified and Traditional), Czech, Danish, Dutch, English, Finnish, French, German, Greek, Hindi, Hungarian, Indonesian, Italian, Japanese, Korean, Norwegian, Persian, Polish, Portuguese (Portugal and Brazil), Romanian, Russian, Spanish, Swedish, Tamil, Thai, Turkish, Ukrainian, Vietnamese

Power source	
Battery	One rechargeable Li-ion EN-EL14a battery
AC adapter	EH-5b AC adapter; requires EP-5A power connector (available separately)

Tripod socket	
Tripod socket	1/4 in. (ISO 1222)

Dimensions/weight	
Dimensions (W × H × D)	Approx. 125 × 98 × 76 mm (4.9 × 3.9 × 3 in.)
Weight	Approx. 530 g (1 lb 2.7 oz) with battery and memory card but without body cap; approx. 480 g/1 lb 0.9 oz (camera body only)

Operating environment	
Temperature	0 °C–40 °C (+32 °F–104 °F)
Humidity	85% or less (no condensation)

- Unless otherwise stated, all measurements are performed in conformity with Camera and Imaging Products Association (CIPA) standards or guidelines.
- All figures are for a camera with a fully-charged battery.
- Nikon reserves the right to change the appearance and specifications of the hardware and software described in this manual at any time and without prior notice. Nikon will not be held liable for damages that may result from any mistakes that this manual may contain.

■ ■ MH-24 Battery Charger

Rated input	AC 100–240 V, 50/60 Hz, 0.2 A maximum
Rated output	DC 8.4 V/0.9 A
Supported batteries	Nikon Rechargeable Li-ion Battery EN-EL14a
Charging time	Approx. 1 hour and 50 minutes at an ambient temperature of 25 °C/77 °F when no charge remains
Operating temperature	0 °C–40 °C (+32 °F–104 °F)
Dimensions (W × H × D)	Approx. 70 × 26 × 97 mm (2.8 × 1.0 × 3.8 in.), excluding plug adapter
Weight	Approx. 96 g (3.4 oz), excluding plug adapter

■ ■ EN-EL14a Rechargeable Li-ion Battery

Type	Rechargeable lithium-ion battery
Rated capacity	7.2 V/1230 mAh
Operating temperature	0 °C–40 °C (+32 °F–104 °F)
Dimensions (W × H × D)	Approx. 38 × 53 × 14 mm (1.5 × 2.1 × 0.6 in.)
Weight	Approx. 49 g (1.7 oz), excluding terminal cover

■ ■ AF-P DX NIKKOR 18–55mm f/3.5–5.6G VR and AF-P DX NIKKOR 18–55mm f/3.5–5.6G Lenses

Type	Type G AF-P DX lens with built-in CPU and F mount
Focal length	18–55 mm
Maximum aperture	f/3.5–5.6
Lens construction	12 elements in 9 groups (2 aspherical lens elements)
Angle of view	76° – 28° 50'
Focal length scale	Graduated in millimeters (18, 24, 35, 45, 55)
Distance information	Output to camera
Zoom	Manual zoom using independent zoom ring
Focusing	Autofocus controlled by stepping motor; separate focus ring for manual focus
Vibration reduction (AF-P DX NIKKOR 18–55mm f/3.5–5.6G VR only)	Lens shift using voice coil motors (VCMs)
Minimum focus distance	0.25 m (0.9 ft) from focal plane at all zoom positions
Diaphragm blades	7 (rounded diaphragm opening)
Diaphragm	Fully automatic
Aperture range	<ul style="list-style-type: none">• 18 mm focal length: f/3.5–22• 55 mm focal length: f/5.6–38 The minimum aperture displayed may vary depending on the size of the exposure increment selected with the camera.
Metering	Full aperture
Filter-attachment size	55 mm (P = 0.75 mm)
Dimensions	Approx. 64.5 mm maximum diameter × 62.5 mm (distance from camera lens-mount flange when lens is retracted)
Weight	<ul style="list-style-type: none">• AF-P DX NIKKOR 18–55mm f/3.5–5.6G VR: Approx. 205 g (7.3 oz)• AF-P DX NIKKOR 18–55mm f/3.5–5.6G: Approx. 195 g (6.9 oz)

■ ■ AF-S DX NIKKOR 18–140mm f/3.5–5.6G ED VR Lens

Type	Type G AF-S DX lens with built-in CPU and F mount
Focal length	18 – 140 mm
Maximum aperture	f/3.5 – 5.6
Lens construction	17 elements in 12 groups (including 1 ED lens element, 1 aspherical lens element)
Angle of view	76° – 11° 30'
Focal length scale	Graduated in millimeters (18, 24, 35, 50, 70, 140)
Distance information	Output to camera
Zoom	Manual zoom using independent zoom ring
Focusing	Nikon Internal Focusing (IF) System with autofocus controlled by Silent Wave Motor and separate focus ring for manual focus
Vibration reduction	Lens shift using voice coil motors (VCMs)
Minimum focus distance	0.45 m (1.48 ft) from focal plane at all zoom positions
Diaphragm blades	7 (rounded diaphragm opening)
Diaphragm	Fully automatic
Aperture range	<ul style="list-style-type: none">• 18 mm focal length: f/3.5 – 22• 140 mm focal length: f/5.6 – 38 The minimum aperture displayed may vary depending on the size of the exposure increment selected with the camera.
Metering	Full aperture
Filter-attachment size	67 mm (P = 0.75 mm)
Dimensions	Approx. 78 mm maximum diameter × 97 mm (distance from camera lens-mount flange)
Weight	Approx. 490 g (17.3 oz)

■ ■ AF-S DX NIKKOR 18–55mm f/3.5–5.6G VR II Lens

Type	Type G AF-S DX lens with built-in CPU and F mount
Focal length	18–55 mm
Maximum aperture	f/3.5–5.6
Lens construction	11 elements in 8 groups (including 1 aspherical lens element)
Angle of view	76°–28° 50′
Focal length scale	Graduated in millimeters (18, 24, 35, 45, 55)
Distance information	Output to camera
Zoom	Manual zoom using independent zoom ring
Focusing	Autofocus controlled by Silent Wave Motor and separate focus ring for manual focus
Vibration reduction	Lens shift using voice coil motors (VCMs)
Minimum focus distance	<ul style="list-style-type: none">• AF: 0.28 m (0.92 ft) from focal plane at all zoom positions• MF: 0.25 m (0.82 ft) from focal plane at all zoom positions
Diaphragm blades	7 (rounded diaphragm opening)
Diaphragm	Fully automatic
Aperture range	<ul style="list-style-type: none">• 18 mm focal length: f/3.5–22• 55 mm focal length: f/5.6–38 <p>The minimum aperture displayed may vary depending on the size of the exposure increment selected with the camera.</p>
Metering	Full aperture
Filter-attachment size	52 mm (P=0.75 mm)
Dimensions	Approx. 66 mm diameter × 59.5 mm (distance from camera lens-mount flange when lens is retracted)
Weight	Approx. 195 g (6.9 oz)

Nikon reserves the right to change the appearance and specifications of the hardware and software described in this manual at any time and without prior notice. Nikon will not be held liable for damages that may result from any mistakes that this manual may contain.

AF-P DX NIKKOR 18–55mm f/3.5–5.6G VR, AF-P DX NIKKOR 18–55mm f/3.5–5.6G

AF-P DX NIKKOR 18–55mm f/3.5–5.6G VR and AF-P DX NIKKOR 18–55mm f/3.5–5.6G feature retractable lens barrels.

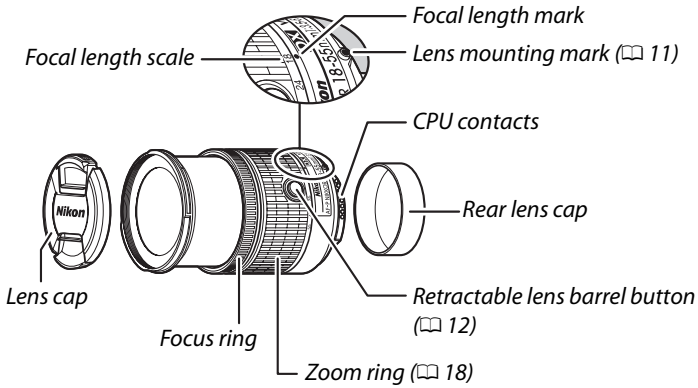

AF-S DX NIKKOR 18–140mm f/3.5–5.6G ED VR

The lens generally used in this manual for illustrative purposes is the AF-S DX NIKKOR 18–140mm f/3.5–5.6G ED VR.

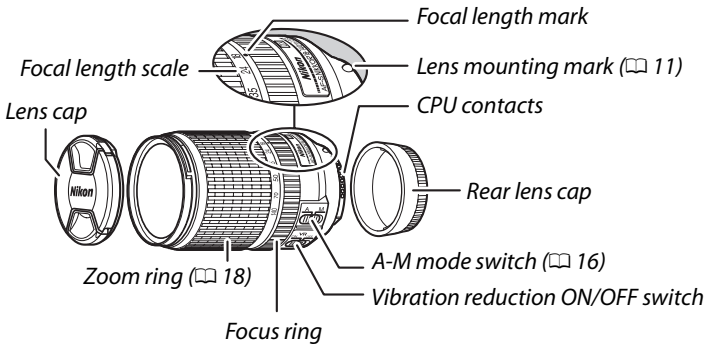

AF-S DX NIKKOR 18–55mm f/3.5–5.6G VR II

The AF-S DX NIKKOR 18–55mm f/3.5–5.6G VR II features a retractable lens barrel.

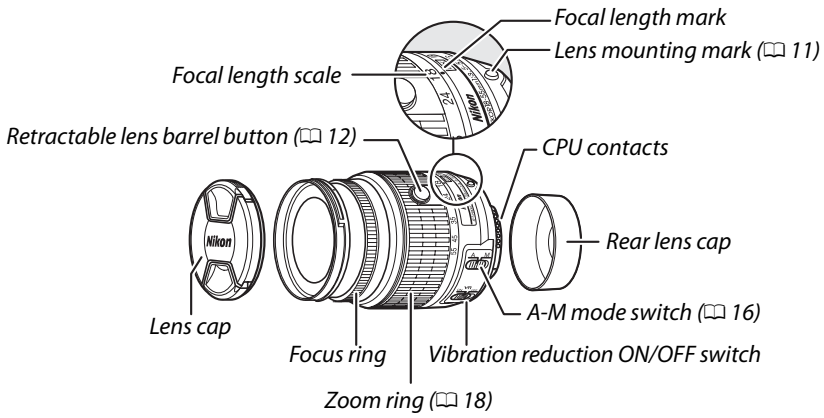

Trademark Information

IOS is a trademark or registered trademark of Cisco Systems, Inc., in the United States and/or other countries and is used under license. Mac OS and OS X are registered trademarks of Apple Inc. in the United States and/or other countries. Microsoft, Windows, and Windows Vista are either registered trademarks, or trademarks of Microsoft Corporation in the United States and/or other countries. PictBridge logo is a trademark. The SD, SDHC, and SDXC logos are trademarks of the SD-3C, LLC. HDMI, the HDMI logo and High-Definition Multimedia Interface are trademarks or registered trademarks of HDMI Licensing LLC.

HDMI

Wi-Fi and the Wi-Fi logo are trademarks or registered trademarks of the Wi-Fi Alliance. All other trade names mentioned in this manual or the other documentation provided with your Nikon product are trademarks or registered trademarks of their respective holders.

Conformity Marking

The standards with which the camera complies can be viewed using the **Conformity marking** option in the setup menu (📖 55).

FreeType License (FreeType2)

Portions of this software are copyright © 2013 The FreeType Project (<http://www.freetype.org>). All rights reserved.

MIT License (HarfBuzz)

Portions of this software are copyright © 2013 The HarfBuzz Project (<http://www.freedesktop.org/wiki/Software/HarfBuzz>). All rights reserved.

Battery Life

The movie footage or number of shots that can be recorded with fully-charged batteries varies with the condition of the battery, temperature, the interval between shots, and the length of time menus are displayed. Sample figures for EN-EL14a (1230 mAh) batteries are given below.

- **Photographs, single-frame release mode (CIPA standard ¹):** Approximately 600 shots
- **Photographs, continuous release mode (Nikon standard ²):** Approximately 2000 shots
- **Movies:** Approximately 50 minutes at 1080/60p and 1080/50p³
 - 1 Measured at 23 °C/73.4 °F (±2 °C/3.6 °F) with an AF-S DX NIKKOR 18–55mm f/3.5–5.6G VR II lens under the following test conditions: lens cycled from infinity to minimum range and one photograph taken at default settings once every 30 s; after photograph is taken, monitor is turned on for 4 s; tester waits for standby timer to expire after monitor is turned off; flash fired at full power once every other shot. Live view not used.
 - 2 Measured at 20 °C/68 °F with an AF-S DX NIKKOR 18–55mm f/3.5–5.6G VR II lens under the following test conditions: vibration reduction off, continuous high-speed release mode, focus mode set to **AF-C**, image quality set to JPEG basic, image size set to **M** (medium), white balance set to **AUTO**, ISO sensitivity set to ISO 100, shutter speed ¹/₂₅₀ s, focus cycled from infinity to minimum range three times after shutter-release button has been pressed halfway for 3 s; six shots are then taken in succession and monitor turned on for 4 s and then turned off; cycle repeated once standby timer has expired.
 - 3 Measured at 23°C/73.4°F (±2°C/3.6°F) with the camera at default settings and an AF-S DX NIKKOR 18–55mm f/3.5–5.6G VR II lens under conditions specified by the Camera and Imaging Products Association (CIPA). Individual movies can be up to 20 minutes in length or 4 GB in size; recording may end before these limits are reached if the camera temperature rises.

The following can reduce battery life:

- Using the monitor
- Keeping the shutter-release button pressed halfway
- Repeated autofocus operations
- Taking NEF (RAW) photographs
- Slow shutter speeds
- Using the built-in Wi-Fi or location data functions, or using an optional location data unit
- Using an Eye-Fi card
- Using VR (vibration reduction) mode with VR lenses
- Repeatedly zooming in and out with an AF-P lens.

To ensure that you get the most from rechargeable Nikon EN-EL14a batteries:

- Keep the battery contacts clean. Soiled contacts can reduce battery performance.
- Use batteries immediately after charging. Batteries will lose their charge if left unused.

No reproduction in any form of this manual, in whole or in part (except for brief quotation in critical articles or reviews), may be made without written authorization from NIKON CORPORATION.

Nikon User Support for India and Australia

Contact a Nikon representative for technical assistance with the operation of your Nikon product or products. For information on the Nikon representatives in your area, visit <http://www.nikon-asia.com/support>.