

Nikon

DIGITAL CAMERA

COOLPIX S810c

User's Manual



En

Convenient Features

The COOLPIX S810c is equipped with a stand by mode that helps to reduce battery power consumption. Select either power off or stand by mode depending on the situation.

To display the selection screen, press and hold the power switch for several seconds while the camera is on.

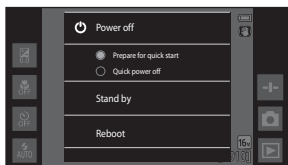
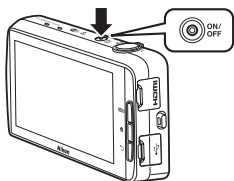

Stand by

Select **Stand by** while shooting.

- When the camera is in stand by mode, press the power switch to turn the monitor back on.

Off

Select **Power off** if you are not using the camera for a while. You can select the options below to control how the camera turns off.

- **Prepare for quick start** (default setting): The status of the camera is saved before turning off. The camera starts up quickly the next time you turn it on.
- **Quick power off**: The camera turns off immediately.

✓ Note

When the use of electronic devices is prohibited or restricted, turn off the camera (ix).

Introduction	
Parts of the Camera	
Basic Steps for Shooting and Playback	
Shooting Features	
Playback Features	
Recording and Playing Back Movies	
General Camera Setup	
Using Android OS	
Connecting the Camera to a TV and Computer	
Technical Notes and Index	

Introduction

Read This First

Thank you for purchasing the Nikon COOLPIX S810c digital camera. Before using the camera, please read the information in "For Your Safety" (📖vii–ix) and familiarize yourself with the information provided in this manual. After reading, please keep this manual handy and refer to it to enhance your enjoyment of your new camera.

Confirming the Package Contents

In the event that any items are missing, please contact the store where you purchased the camera.



COOLPIX S810c
Digital Camera



Camera Strap



Rechargeable Li-ion
Battery
EN-EL23
(with Terminal Cover)



Charging AC Adapter
EH-71P*

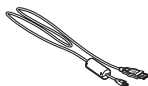

USB Cable UC-E21

- *User's Manual* (this manual)
- *Warranty*

* A plug adapter is included if the camera was purchased in a country or region that requires a plug adapter. The shape of the plug adapter varies with the country or region of purchase (📖12).

NOTE: A memory card is not included with the camera.

About This Manual

If you want to start using the camera right away, see “Basic Steps for Shooting and Playback” (📖10).

To learn about the parts of the camera and basic operations, see “Parts of the Camera” (📖1).

Downloading the “Reference Manual”

Refer to the COOLPIX S810c *Reference Manual* (PDF format) for more detailed information.







The *Reference Manual* can be downloaded from the Nikon website.

<http://nikonimglib.com/manual/>

The *Reference Manual* can be viewed using Adobe Reader.

Other Information

- Symbols and conventions

Symbol	Description
	This icon indicates cautions and information that should be read before using the camera.
	This icon indicates notes and information that should be read before using the camera.
  	These icons indicate other pages containing relevant information;  *: “Reference Section”,  : “Technical Notes and Index.”

- * Refer to the *Reference Manual* for pages indicated with .
- microSDHC/microSDXC memory cards are referred to as “memory cards” in this manual.
- The setting at the time of purchase is referred to as the “default setting.”
- The names of menu items displayed in the camera monitor, and the names of buttons or messages displayed on a computer monitor appear in bold.
- In this manual, images are sometimes omitted from monitor display samples so that monitor indicators can be more clearly shown.
- Illustrations and monitor content shown in this manual may differ from the actual product.

Information and Precautions

Life-Long Learning

As part of Nikon's "Life-Long Learning" commitment to ongoing product support and education, continually updated information is available online at the following sites:

- For users in the U.S.A.: <http://www.nikonusa.com/>
- For users in Europe and Africa: <http://www.europe-nikon.com/support/>
- For users in Asia, Oceania, and the Middle East: <http://www.nikon-asia.com/>

Visit these sites to keep up-to-date with the latest product information, tips, answers to frequently asked questions (FAQs), and general advice on digital imaging and photography. Additional information may be available from the Nikon representative in your area. Visit the site below for contact information.

<http://imaging.nikon.com/>

Use Only Nikon Brand Electronic Accessories

Nikon COOLPIX cameras are designed to the highest standards and include complex electronic circuitry. Only Nikon brand electronic accessories (including battery chargers, batteries, Charging AC Adapters, AC adapters and, USB cables) certified by Nikon specifically for use with this Nikon digital camera are engineered and proven to operate within the operational and safety requirements of this electronic circuitry. **THE USE OF NON-NIKON ELECTRONIC ACCESSORIES COULD DAMAGE THE CAMERA AND MAY VOID YOUR NIKON WARRANTY.**

The use of third-party rechargeable Li-ion batteries not bearing the Nikon holographic seal could interfere with normal operation of the camera or result in the batteries overheating, igniting, rupturing, or leaking.

For more information about Nikon brand accessories, contact a local authorized Nikon dealer.



Holographic seal:

Identifies this device as an authentic Nikon product.

Before Taking Important Pictures

Before taking pictures on important occasions (such as at weddings or before taking the camera on a trip), take a test shot to ensure that the camera is functioning normally. Nikon will not be held liable for damages or lost profits that may result from product malfunction.

About the Manuals

- No part of the documentation included with this product may be reproduced, transmitted, transcribed, stored in a retrieval system, or translated into any language in any form, by any means, without Nikon's prior written permission.
- Nikon reserves the right to change the specifications of the hardware and software described in the documentation at any time and without prior notice.
- Nikon will not be held liable for any damages resulting from the use of this product.
- While every effort was made to ensure that the information in the documentation is accurate and complete, we would appreciate it were you to bring any errors or omissions to the attention of the Nikon representative in your area (address provided separately).

Notice Concerning Prohibition of Copying or Reproduction

Note that simply being in possession of material that was digitally copied or reproduced by means of a scanner, digital camera or other device may be punishable by law.

• **Items prohibited by law from being copied or reproduced**

Do not copy or reproduce paper money, coins, securities, government bonds or local government bonds, even if such copies or reproductions are stamped "Sample." The copying or reproduction of paper money, coins, or securities which are circulated in a foreign country is prohibited. Unless the prior permission of the government was obtained, the copying or reproduction of unused postage stamps or post cards issued by the government is prohibited. The copying or reproduction of stamps issued by the government and of certified documents stipulated by law is prohibited.

• **Cautions on certain copies and reproductions**

The government has issued cautions on copies or reproductions of securities issued by private companies (shares, bills, checks, gift certificates, etc.), commuter passes, or coupon tickets, except when a minimum of necessary copies are to be provided for business use by a company. Also, do not copy or reproduce passports issued by the government, licenses issued by public agencies and private groups, ID cards and tickets, such as passes and meal coupons.

• **Comply with copyright notices**

The copying or reproduction of copyrighted creative works such as books, music, paintings, woodcut prints, maps, drawings, movies, and photographs (including those downloaded from the Internet, and those originally installed on or captured by the camera) is governed by national and international copyright laws. Do not use this product for the purpose of making illegal copies or to infringe copyright laws.

Disposing of Data Storage Devices

Please note that deleting images or formatting data storage devices such as memory cards or built-in camera memory does not completely erase the original image data. Deleted files can sometimes be recovered from discarded storage devices using commercially available software, potentially resulting in the malicious use of personal image data. Ensuring the privacy of such data is the user's responsibility.

Before discarding a data storage device or transferring ownership to another person, erase all data using commercial deletion software, or format the device and then completely refill it with images containing no private information such as images of the sky or ground (with the **Record location data** (📖78) option set to **Off**). Care should be taken to avoid injury or damage to property when physically destroying data storage devices.

For Your Safety

To prevent damage to your Nikon product or injury to yourself or to others, read the following safety precautions in their entirety before using this equipment. Keep these safety instructions where all those who use the product will read them.

The consequences that could result from failure to observe the precautions listed in this section are indicated by the following symbol:



This icon marks warnings, information that should be read before using this Nikon product, to prevent possible injury.

WARNINGS

Turn off in the event of malfunction

Should you notice smoke or an unusual smell coming from the camera or Charging AC Adapter, unplug the Charging AC Adapter and remove the battery immediately, taking care to avoid burns. Continued operation could result in injury. After removing or disconnecting the power source, take the equipment to a Nikon-authorized service representative for inspection.

Do not disassemble

Touching the internal parts of the camera or Charging AC Adapter could result in injury. Repairs should be performed only by qualified technicians. Should the camera or Charging AC Adapter break open as the result of a fall or other accident, take the product to a Nikon-authorized service representative for inspection, after unplugging the product and/or removing the battery.

Do not use the camera or Charging AC Adapter in the presence of flammable gas

Do not use electronic equipment in the presence of flammable gas, as this could result in explosion or fire.

Handle the camera strap with care

Never place the strap around the neck of an infant or child.

Keep out of reach of children

Particular care should be taken to prevent infants from putting the battery or other small parts into their mouths.

Do not remain in contact with the camera, battery charger, or AC adapter for extended periods while the devices are on or in use.

Parts of the devices become hot. Leaving the devices in direct contact with the skin for extended periods may result in low-temperature burns.

 **Do not leave the product where it will be exposed to extremely high temperatures, such as in an enclosed automobile or in direct sunlight**

Failure to observe this precaution could cause damage or fire.

 **Observe caution when handling the battery**

The battery may leak, overheat or explode if improperly handled. Observe the following precautions when handling the battery for use in this product:

- Before replacing the battery, turn the product off. If you are using the Charging AC Adapter/AC adapter, be sure it is unplugged.
- Use only a Rechargeable Li-ion Battery EN-EL23 (included). Charge the battery by using a camera that supports battery charging. To perform this operation, use the Charging AC Adapter EH-71P (included) and USB cable UC-E21 (included). The Battery Charger MH-67P (available separately) is also available to charge the battery without using a camera.
- When inserting the battery, do not attempt to insert it upside down or backwards.
- Do not short or disassemble the battery or attempt to remove or break the battery insulation or casing.
- Do not expose the battery to flame or excessive heat.
- Do not immerse in or expose to water.
- Replace the terminal cover before transporting the battery. Do not transport or store with metal objects such as necklaces or hairpins.
- The battery is prone to leakage when fully discharged. To avoid damage to the product, be sure to remove the battery when no charge remains.
- Discontinue use immediately should you notice any change in the battery, such as discoloration or deformation.
- If liquid from the damaged battery comes in contact with clothing or skin, rinse immediately with plenty of water.

 **Observe the following precautions when handling the Charging AC Adapter**

- Keep dry. Failure to observe this precaution could result in fire or electric shock.
- Dust on or near the metal parts of the plug should be removed with a dry cloth. Continued use could result in fire.
- Do not handle the plug or go near the Charging AC Adapter during lightning storms. Failure to observe this precaution could result in electric shock.
- Do not damage, modify, forcibly tug or bend the USB cable, place it under heavy objects, or expose it to heat or flames. Should the insulation be damaged and the wires become exposed, take it to a Nikon-authorized service representative for inspection. Failure to observe these precautions could result in fire or electric shock.

- Do not handle the plug or Charging AC Adapter with wet hands. Failure to observe this precaution could result in electric shock.
- Do not use with travel converters or adapters designed to convert from one voltage to another or with DC-to-AC inverters. Failure to observe this precaution could damage the product or cause overheating or fire.

 **Use the appropriate power supply (battery, Charging AC adapter, AC adapter, USB cable)**

Using a power supply other than those provided or sold by Nikon could result in damage or malfunction.

 **Use appropriate cables**

When connecting cables to the input and output jacks, use only the cables provided or sold by Nikon for the purpose, to maintain compliance with product regulations.

 **Handle moving parts with care**

Be careful that your fingers or other objects are not pinched by the lens cover or other moving parts.

 **Using the flash close to your subject's eyes could cause temporary visual impairment.**

The flash should be no less than 1 meter (3 ft 4 in.) from the subject. Particular care should be observed when photographing infants.

 **Do not operate the flash with the flash window touching a person or object**

Failure to observe this precaution could result in burns or fire.

 **Avoid contact with liquid crystal**

Should the monitor break, care should be taken to avoid injury caused by broken glass and to prevent liquid crystal from the monitor touching the skin or entering the eyes or mouth.

 **Turn the power off when using inside an airplane or the hospital**

Turn the power off while inside the airplane during take off or landing. Do not use wireless network functions while in the air. Follow the instructions of the hospital when using while in a hospital. The electromagnetic waves emitted by this camera may disrupt the electronic systems of the airplane or the instruments of the hospital.

 **Do Not Use a Headset or Earphones While Driving or Walking**

This may cause accidents.

Notices

Notices for Customers in the U.S.A.

IMPORTANT SAFETY INSTRUCTIONS—SAVE THESE INSTRUCTIONS.

DANGER - TO REDUCE THE RISK OF FIRE OR ELECTRIC SHOCK, CAREFULLY FOLLOW THESE INSTRUCTIONS

For connection to a supply not in the U.S.A., use an attachment plug adapter of the proper configuration for the power outlet if needed.

The power supply unit is intended to be correctly orientated in a vertical or floor mount position.

Federal Communications Commission (FCC) Radio Frequency Interference Statement

This equipment has been tested and found to comply with the limits for a Class B digital device, pursuant to part 15 of the FCC Rules. These limits are designed to provide reasonable

protection against harmful interference in a residential installation. This equipment generates, uses and can radiate radio frequency energy and, if not installed and used in accordance with the instructions, may cause harmful interference to radio communications. However, there is no guarantee that interference will not occur in a particular installation. If this equipment does cause harmful interference to radio or television reception, which can be determined by turning the equipment off and on, the user is encouraged to try to correct the interference by one or more of the following measures:

- Reorient or relocate the receiving antenna.
- Increase the separation between the equipment and receiver.
- Connect the equipment into an outlet on a circuit different from that to which the receiver is connected.
- Consult the dealer or an experienced radio/ TV technician for help.



Nikon

COOLPIX S810c

CAUTIONS

Modifications

The FCC requires the user to be notified that any changes or modifications made to this device that are not expressly approved by Nikon Corporation may void the user's authority to operate the equipment.

Interface Cables

Use the interface cables sold or provided by Nikon for your equipment. Using other interface cables may exceed the limits of Class B Part 15 of the FCC rules.

Notice for customers in the State of California

WARNING

Handling the cord on this product will expose you to lead, a chemical known to the State of California to cause birth defects or other reproductive harm.

Wash hands after handling.

Nikon Inc.,
1300 Walt Whitman Road
Melville, New York 11747-3064
USA
Tel: 631-547-4200

Notice for Customers in Canada

CAN ICES-3 B / NMB-3 B

Notices for Customers in Europe

CAUTIONS

**RISK OF EXPLOSION IF BATTERY IS REPLACED BY AN INCORRECT TYPE.
DISPOSE OF USED BATTERIES ACCORDING TO THE INSTRUCTIONS.**

**TO PREVENT POSSIBLE HEARING DAMAGE, DO NOT LISTEN AT
HIGH VOLUME LEVELS FOR LONG PERIODS.**



This symbol indicates that electrical and electronic equipment is to be collected separately.

The following apply only to users in European countries:

- This product is designated for separate collection at an appropriate collection point. Do not dispose of as household waste.
- Separate collection and recycling helps conserve natural resources and prevent negative consequences for human health and the environment that might result from incorrect disposal.
- For more information, contact the retailer or the local authorities in charge of waste management.



This symbol on the battery indicates that the battery is to be collected separately. The following apply only to users in European countries:

- All batteries, whether marked with this symbol or not, are designated for separate collection at an appropriate collection point. Do not dispose of as household waste.
- For more information, contact the retailer or the local authorities in charge of waste management.



Wi-Fi (Wireless LAN Network) Function

This product is controlled by the United States Export Administration Regulations, and you are required to obtain permission from the United States government if you export or re-export this product to any country to which the United States embargoes goods. The following countries were subject to embargo: Cuba, Iran, North Korea, Sudan, and Syria. Since the target countries are subject to change, please contact the United States Department of Commerce for the latest information.

Restrictions on Wireless Devices

The wireless transceiver included in this product conforms to wireless regulations in the country of sale and is not for use in other countries (products purchased in the EU or EFTA can be used anywhere within the EU and EFTA). Nikon does not accept liability for use in other countries. Users who are unsure as to the original country of sale should consult with their local Nikon service center or Nikon-authorized service representative. This restriction applies to wireless operation only and not to any other use of the product.

Notice for Customers in the U.S.A. and Canada

Federal Communications Commission (FCC) and Industry of Canada (IC)

Declaration of Conformity

This device complies with Part 15 of FCC Rules and Industry Canada licence-exempt RSS standard(s). Operation is subject to the following two conditions: (1) this device may not cause interference, and (2) this device must accept any interference, including interference that may cause undesired operation of this device.

FCC/IC RF Exposure Statement

This transmitter must not be co-located or operated in conjunction with any other antenna or transmitter.

The available scientific evidence does not show that any health problems are associated with using low power wireless devices. There is no proof, however, that these low power wireless devices are absolutely safe. Low power wireless devices emit low levels of radio frequency energy (RF) in the microwave range while being used. Whereas high levels of RF can produce health effects (by heating tissue), exposure to low-level RF that does not produce heating effects causes no known adverse health effects. Many studies of low-level RF exposures have not found any biological effects. Some studies have suggested that some biological effects might occur, but such findings have not been confirmed by additional research.

COOLPIX S810c, which is equipped with a DW092 (FCC ID:EW4DW092/IC ID:4634A-3149EC) Wireless LAN Module, has been tested and found to comply with FCC/IC radiation exposure limits set forth for an uncontrolled environment and meets the FCC radio frequency (RF) Exposure Guidelines in Supplement C to OET65 and RSS-102 of the IC radio frequency (RF) Exposure rules. Please refer to the SAR test report that was uploaded to FCC website.

Declaration of Conformity (Europe)

Hereby, Nikon Corporation, declares that COOLPIX S810c is in compliance with the essential requirements and other relevant provisions of Directive 1999/5/EC. The declaration of conformity may be consulted at http://imaging.nikon.com/support/pdf/DoC_S810c.pdf.

Notice for Customers in Singapore

This device complies with radio-frequency regulations.

<p align="center">Complies with IDA Standards DA103423</p>

Notice for Customers in the Sultanate of Oman

This device complies with radio-frequency regulations.

OMAN - TRA
R/0934/13
D100428

Notice for Customers in Jamaica

This product contains a Type Approved Module by Jamaica : "SMA - DW092"

Notice for customers in the United Arab Emirates

This device complies with radio-frequency regulations.

<p>TRA REGISTERED No. ER0103077/13 DEALER No. DA0087468/12</p>

הודעה ללקוחות במדינת ישראל

ההתקן תואם לתקנות תדרי רדיו.

יש לנהוג באמצעי זהירות בעת השימוש באפשרויות התקשורת

א. נקודות הגישה תהיה מיועדת אך ורק לחיבור משתמש תמצוי בחצרים מתוחמים (דוגמת בית, בית עסק, מתחם שדה תעופה, קמפוס אוניברסיטאי וכו')

ב. לצורך גישה לאינטרנט, נקודת הגישה תקושר מחוץ לחצרים אך ורק אל בעל רשיון למתן שירות גישה לאינטרנט (ISP, להלן-ספק אינטרנט). הקישור לספק אינטרנט יהיה אך ורק באמצעות קו תקשורת נתונים המסופק בידי בעל רשיון למתן שירותי תקשורת נתונים;

ג. קישור נקודת הגישה מחוץ לחצרים לצורך תקשורת נתונים ייעשה באמצעות תשתיות של בעל רשיון מתאים ובלבד שלא ייעשה שימוש בקישור כאמור לצורך העברת קול (VOICE)

ד. לצורך שרות לצד ג' נדרש רשיון נוסף מאגף הנדסה ורישוי (משרד התקשורת).

Precautions when Using Radio Transmissions

- Always keep in mind that radio transmission or reception of data is subject to interception by third parties. Note that Nikon is not responsible for data or information leaks that may occur during data transfer.
- The operating frequency band of this equipment is used by industrial, scientific, consumer and medical equipment including microwave ovens, premises radio stations for identifying mobile units used in the manufacturing lines of plants (radio stations requiring no license), and amateur radio stations (hereinafter referred to as "another station"). 1. Before using this equipment, confirm that another station is not being operated nearby. 2. In the event of this equipment causing harmful radio wave interference with another station, promptly change the operating frequency or stop radio wave emission by turning off the power, etc. 3. If you have further questions, contact a Nikon service center or Nikon authorized service representative.

Precautions when Using the Wireless LAN Functions

- When using the LAN function of this product, the product will search for wireless networks automatically. At this time, the product may display wireless networks (SSIDs) for which you are not an authorized user. Use of such a wireless network may be regarded as unauthorized access. Never connect to an SSID that you are not authorized to use.

Personal Information Management and Disclaimer

- User information registered and configured on the product, including wireless LAN connection settings and other personal information, is susceptible to alteration and loss resulting from operational error, static electricity, accident, malfunction, repair or other handling. Always keep separate copies of important information. Nikon is not responsible for any direct or indirect damages or lost profits resulting from alteration or loss of content that is not attributable to Nikon.
- Before discarding this product or transferring it to another owner, it is recommended that you apply the reset option from **Factory data reset** in **Backup & reset** and **Erase SD card** in **Storage** in the Android™ OS (86) setting menu, to delete all user information registered and configured with the product, including wireless LAN connection settings and other personal information.
- Nikon is not responsible for any communication charges stemming from unauthorized access to a public wireless LAN by third parties, or any other damages resulting from theft of the product.
- Nikon is not responsible for any damages stemming from unauthorized use of email addresses stored in the camera resulting from theft of the product.

Notes About GPS

Notes About Personal Information

An individual may be identified from still images or movies that have been recorded with location information. Observe caution when you transfer still images or movies recorded with location information to a third party or upload them to a network such as the Internet where the public can view them. Be sure to read “Disposing of Data Storage Devices” (📖vi).



Using the Camera Overseas

- Before taking the camera with GPS function overseas for travel, consult your travel agency or embassy of the country you are visiting to confirm whether there is any restriction on use.
- The GPS may not function properly in China and on the borders between China and neighboring countries (as of October 2013).

Table of Contents

Introduction	ii
Read This First	ii
Confirming the Package Contents.....	ii
About This Manual	iii
Information and Precautions.....	iv
For Your Safety	vii
WARNINGS.....	vii
Notices	x
Wi-Fi (Wireless LAN Network) Function	xiii
Notes About GPS	xvii
<hr/>	
Parts of the Camera	1
The Camera Body	1
Attaching the Camera Strap.....	2
Using the Camera Buttons	3
Using the Menu by Pressing and Holding the Power Switch	3
Operating the Touch Panel	4
Indicators of the Monitor/Touch Panel	6
Shooting Mode	6
Playback Mode	8
<hr/>	
Basic Steps for Shooting and Playback	10
Preparation 1 Insert the Battery	10
Preparation 2 Charge the Battery	12
Preparation 3 Insert a Memory Card	14
Internal Memory and Memory Cards.....	15
Preparation 4 Configuring Various Settings	16
Date & Time Settings	17
Step 1 Turn the Camera On	18
Taking Pictures Immediately After Turning on the Camera.....	19
Step 2 Select a Shooting Mode	20
Available Shooting Modes	21
Step 3 Frame a Picture	22
Using the Zoom.....	23
Step 4 Focus and Shoot	24
The Shutter-release Button.....	25



























































Refer to the *Reference Manual* for pages indicated with .



































Step 5 Play Back Images	26
Step 6 Delete Images.....	28
Step 7 Turn the Camera Off.....	30
Power Saving Function	31
Adding Comments to Images.....	32
Adding Comments when Shooting.....	32
Adding Comments when Playing Back.....	33
Viewing/Editing Comments.....	33
<hr/>	
Shooting Features.....	34
 (Easy Auto) Mode	34
 (Auto) Mode	35
Scene Mode (Shooting Suited to Scenes).....	37
Tips and Notes.....	39
Special Effects Mode (Applying Effects When Shooting).....	42
Smart Portrait Mode (Shooting Smiling Faces).....	44
Basic Shooting Settings	46
Using the Flash	47
Using the Self-timer.....	49
Using Macro Mode.....	51
Adjusting Brightness (Exposure Compensation)	52
Default Settings.....	53
Functions That Can Be Set with the MENU Button (Shooting Menu)	55
Shooting Menu Options.....	56
Functions That Cannot Be Used Simultaneously	57
Focusing on Subjects	60
Using Target Finding AF	60
Face Detection.....	61
Skin Softening	62
Subjects Not Suitable for Autofocus.....	62
Focus Lock.....	63
<hr/>	
Playback Features.....	64
Playback Zoom	64
Thumbnail Playback	65
Timeline View (Chronological Display)	66
Adding Images to a Timeline	66
Displaying Images in Timeline View.....	68
Functions That Can Be Set with the MENU Button (Timeline Menu).....	69

Refer to the *Reference Manual* for pages indicated with .



Functions That Can be Set with the MENU Button (Playback Menu)	70
<hr/>	
Recording and Playing Back Movies.....	72
Recording Movies.....	72
Functions That Can be Set with the MENU Button (Movie menu).....	75
Movie Playback.....	76
<hr/>	
General Camera Setup.....	77
Functions That Can Be Set with the MENU Button (Setup Menu)	77
<hr/>	
Using Android OS.....	79
Basic Operations for the Home Screen	79
Indicators on the Home Screen	79
Activating the Main Applications.....	80
Using Status Bar	81
Switching the Screen.....	81
Using the Option Menu.....	82
Using Google Search Bar.....	82
Entering Text.....	83
Using the Keyboard.....	83
Other Keyboard Operations	84
Editing Text	84
Using the Voice Typing Function.....	85
Using Android OS Setting Menu	86
Using the Internet.....	88
Setting Up a Wi-Fi (Wireless LAN) Network	88
Setting Up a Google Account	90
Sharing Images.....	91
Using the Internet.....	92
Using Google Play Store (Getting Applications).....	93
<hr/>	
Connecting the Camera to a TV and Computer	94
Connection Methods.....	94
Using ViewNX 2	96
Installing ViewNX 2	96
Transferring Images to the Computer	97
Viewing Images.....	99

Refer to the <i>Reference Manual</i> for pages indicated with  .







Reference Section		1
Using Easy Panorama (Shooting and Playback)		2
Shooting with Easy Panorama		2
Viewing Images Captured with Easy Panorama		5
Editing Images (Still Images)		6
Before Editing Images		6
 Quick Retouch: Enhancing Contrast and Saturation		7
 D-Lighting: Enhancing Brightness and Contrast		8
 Filter Effects: Digital Filters		9
 Skin Softening: Softening Skin Tones		11
 Small Picture: Making Smaller Images		12
 Crop: Creating a Cropped Copy		13
Connecting the Camera to a TV (Playback on a TV)		14
Transferring Images to Your Smart Device		16
Installing the Connect to S810c Application on Your Smart Device		16
Configuring the Connection Settings Between the Camera and Your Smart Device (Simple Setup)		17
Transferring Images from Camera to Smart Device		19
Changing the Connect to S810c Application Settings		21
The Shooting Menu (for  (Auto) Mode)		22
 Image Mode (Image Size and Quality)		22
 Touch Shooting		23
ISO ISO Sensitivity		29
 Continuous		30
WB White Balance (Adjusting Hue)		32
 AF Area Mode		34
The Smart Portrait Menu		36
 Skin Softening		36
 Blink Proof		37
 Smile Timer		38
The Playback Menu		39
 Add to/Remove from Timeline View		39
 Erase Location Data		39
 Slide Show		40
 Protect		41
 Print Order (Creating a DPOF Print Order)		43
 Rotate Image		46
 Copy (Copy Between Internal Memory and Memory Card)		47

The Movie Menu	 49
 Movie Options.....	 49
 Touch Shooting	 50
AF Autofocus Mode.....	 51
 Wind Noise Reduction	 51
The Setup Menu	 52
Welcome Screen.....	 52
Monitor Settings	 52
Print Date (Imprinting Date and Time).....	 54
Vibration Reduction.....	 55
AF Assist	 56
Digital Zoom	 56
Shutter Sound	 57
HDMI	 57
Blink Warning.....	 58
Record Location Data.....	 59
Reset All.....	 60
Firmware Version	 60
Basic Settings for the Android OS	 61
Wi-Fi	 61
Touch Sounds	 62
Brightness	 62
Display Off	 62
Shut-down Timer	 63
Erase SD Card (Format)	 63
Location Access	 64
Language	 67
Reboot	 67
Factory Data Reset	 67
Error Messages	 68
File Names	 71
Optional Accessories	 72

Technical Notes and Index..... 1

Caring for the Product	 2
The Camera.....	 2
The Battery	 3
Charging AC Adapter	 4
Memory Cards.....	 5

Refer to the *Reference Manual* for pages indicated with .

Cleaning and Storage.....		6
Cleaning.....		6
Storage		6
Troubleshooting		7
Specifications		15
Approved Memory Cards.....		20
Index.....		23



A series of horizontal dashed lines spanning the width of the page, intended for handwriting practice.

Parts of the Camera

The Camera Body

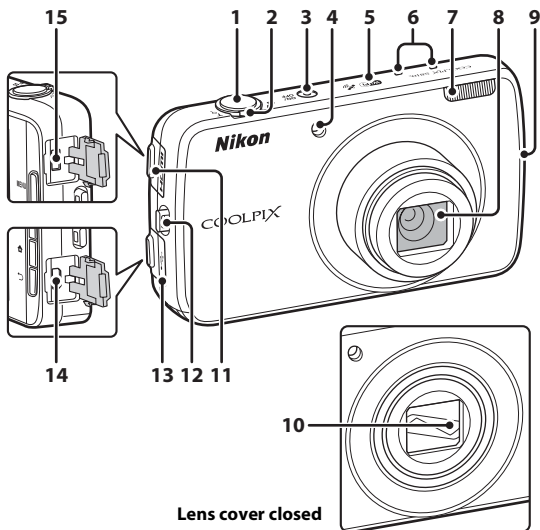

1	Shutter-release button..... 24	8	Lens
2	Zoom control..... 23	9	Wi-Fi (wireless LAN) antenna
	W : wide-angle 23	10	Lens cover
	T : telephoto..... 23	11	HDMI connector cover..... 94, 14
	: thumbnail playback..... 65	12	Eyelet for camera strap..... 2
: playback zoom..... 64	3	13	USB connector cover 12, 94, 97
Power switch/power-on lamp 13, 18		14	Micro-USB connector..... 12, 94, 97
4	Self-timer lamp..... 49	15	HDMI Micro connector (Type D) 94, 14
	AF-assist illuminator..... 77, 56		
5	GPS antenna..... 65		
6	Microphone (stereo)..... 72, 85		
7	Flash..... 47		

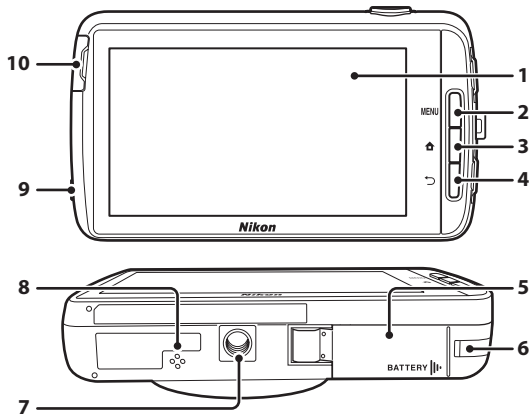

1	Monitor/touch panel.....4, 6	7	Tripod socket
2	MENU (menu) button3, 55, 70, 75, 77, 82	8	Speaker 76
3	⬆ (home) button 3, 79	9	Headset connector 76, 93
4	⬅ (back) button 3	10	Memory card slot cover..... 14
5	Battery chamber cover..... 10		
6	Power connector cover (for connection with optional AC Adapter)  72		

Attaching the Camera Strap

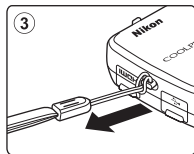
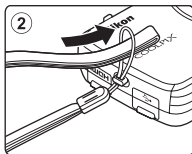
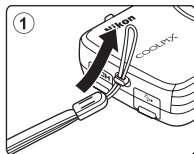

Using the Camera Buttons

Use the method described below.

MENU (menu) button

- Press the **MENU** button to display menus.
The shooting menu or playback menu is displayed when using the camera, and the option menu is displayed when using Android OS. Tap a menu option to select it.

🏠 (home) button

- Press the 🏠 button to display the home screen (📖79).
- To display the list screen showing the most recently used applications, press and hold the 🏠 button for a few seconds on the home screen.
- To turn on the camera and display the home screen, press and hold the 🏠 button for a few seconds while the camera is off.

↶ (back) button

- Press the ↶ button to return to the previous screen.
- The message **Press again to exit.** is displayed when you press the ↶ button on the shooting screen (📷70). To return to the shooting screen, press the shutter-release button.

Using the Menu by Pressing and Holding the Power Switch

While the camera is on, press and hold the power switch for several seconds to select the menu options listed below.

- **Power off:** The camera turns off (📖30).
- **Stand by:** The camera enters stand by mode (📖30).
- **Reboot:** The camera restarts (📖87).
- **Screenshot:** The currently displayed image is saved as an image file.

Operating the Touch Panel

The monitor on this camera is a touch panel display operated by finger. Use the method described below.

Tapping

Tap the touch panel.

Use this operation to:

- Select icons
- Select images in thumbnail playback mode (📖65)
- Perform touch shooting operations (📖56)

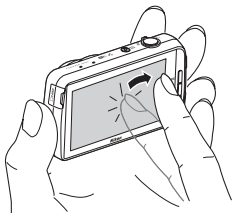

Touching and Holding

Place your finger on an item or icon, and hold it there for several seconds.

Use this operation to:

- Edit text (📖84)

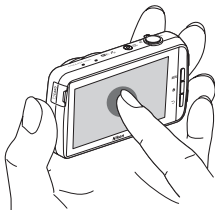

Dragging

Drag your finger across the touch panel and remove it from the touch panel.

Use this operation to:

- Scroll through images in full-frame playback mode (📖26)
- Move the visible portion of an image enlarged with playback zoom (📖64)
- Move sliders such as when adjusting exposure compensation (📖52)

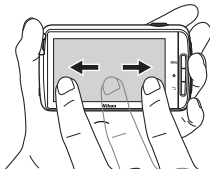

Spreading/Pinching

Spread two fingers apart/pinch two fingers together.

Use this operation to:

- Zoom in/out on an image (📖64) in playback mode
- Switch to thumbnail playback mode from full-frame playback mode (📖65)

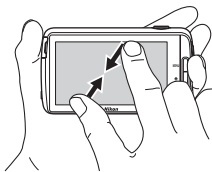
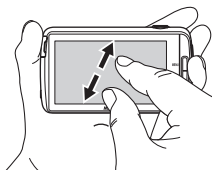

Flicking

Place your finger on the touch panel and quickly move it up, down, right, or left and release it to scroll.

Use this operation to:

- Switch the screen (📖81)

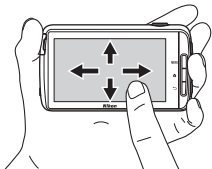

✓ Notes About the Touch Panel

- This camera utilizes a static touch panel. Therefore, it may not respond when touched with fingernails or gloved fingers.
- Do not press on the touch panel with pointed objects.
- Do not apply unnecessary pressure to the touch panel.
- The touch panel may not respond to touch if a commercially available protecting film is applied.

✓ Notes About Touch Panel Operations

- The camera may not respond if your finger is left in one place too long.
- The camera may not respond if the followings are made.
 - Bounce your finger off the display
 - Drag your finger over too short a distance
 - Stroke the display too lightly
 - Move your finger too quickly
 - Fail to move both fingers simultaneously when spreading or pinching
- The camera may not respond if something else is touching the touch panel when your finger touches it.









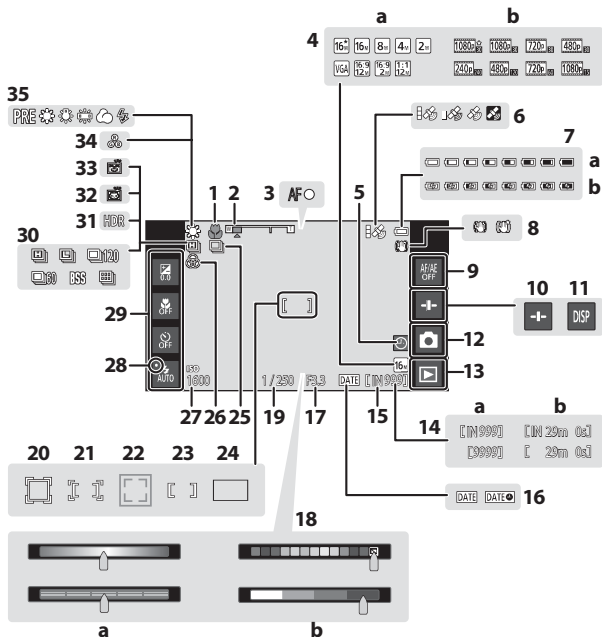





Indicators of the Monitor/Touch Panel

The information that is displayed in the monitor during shooting and playback changes depending on the camera's settings and state of use. By default, the camera turns off after a few seconds (when **Photo info** is set to **Auto info** in **Monitor settings** (📖77)).

Shooting Mode

When the operation icons and indicators are hidden on the shooting screen, tap **DISP** to display them again.



1	Macro mode.....	51	18	a Creative slider/Scene effect adjustment slider.....	36, 38
2	Zoom indicator.....	23, 51	b Special effect adjustment slider	43	
3	Focus indicator.....	24	19	Shutter speed.....	25
4	a Image mode.....	56,  22	20	Focus area (subject tracking)	56,  26
	b Movie options.....	75,  49	21	Focus area (touch AF/AE)	56,  28
5	"Date not set" indicator.....	16	22	Focus area (pet or face detection)	41, 61
6	GPS reception status.....	78,  59	23	Focus area (center).....	63
7	a Battery level indicator.....	18	24	Focus area (target finding AF).....	60
	b Battery charging indicator	13, 18	25	Continuous shooting (pet portrait or smart portrait scene mode)	41, 44
8	Vibration reduction icon	77,  55	26	Adjusted the vividness.....	36
9	Touch AF/AE cancellation	56,  26,  28	27	ISO sensitivity.....	56,  29
10	Slider display.....	36, 38, 43	28	Flash indicator.....	47
11	Information redisplay.....	6,  53	29	Basic shooting settings ³	47, 49, 51, 52
12	Shooting mode ¹	20, 21	30	Continuous shooting (when using auto shooting mode).....	56,  30
13	Playback mode (switch to playback mode) ²	26	31	Backlighting (HDR).....	40
14	a Number of exposures remaining (still images).....	18,  22	32	Pet portrait auto release.....	41
	b Movie length.....	72	33	Smile timer.....	56,  38
15	Internal memory indicator.....	18	34	Adjusted the hue.....	36
16	Print date indicator.....	25, 77,  54	35	White balance.....	56,  32
17	Aperture.....	25			

¹ Icons displayed vary depending on current shooting mode.





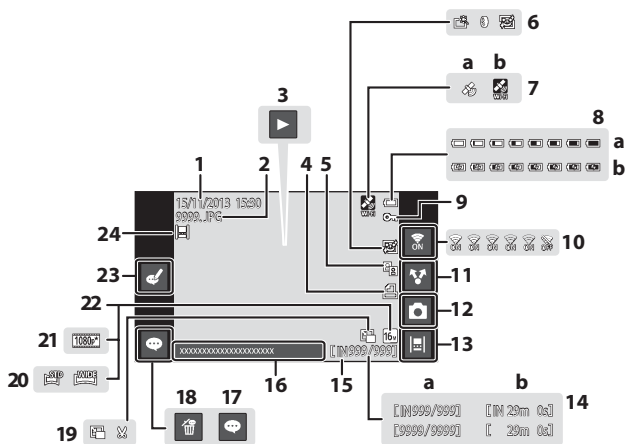

² After an image is taken, its preview image is displayed.

³ Each icon also indicates the current setting.

Playback Mode

If you tap anywhere on the playback screen other than on an operation icon, the information is hidden regardless of the setting in **Photo info** (77). Tap the monitor to display the information again.



1	Date/time of recording.....	17	12	Shooting mode (switch to shooting mode) ¹	26
2	File number and type	71	13	Timeline view	66
3	Movie playback.....	76	a	Current frame number/ total number of frames.....	26
	Easy panorama playback....	40, 45	b	Movie length.....	76
4	Print order icon	70, 43	15	Internal memory indicator.....	15
5	 D-Lighting icon	70, 48	16	Display comment.....	33
6	 Quick retouch icon.....	70, 47	17	Add comment.....	33
	 Filter effects icon	70, 49	18	Delete comment	33
	 Skin softening icon.....	70, 41	19	 Small picture icon	70, 12
7	Recorded location data	78, 59	 Crop icon.....	64, 13	
	a Using GPS		20	Easy panorama icon.....	40, 44
	b Using Wi-Fi		21	Movie options ²	75, 49
8	a Battery level indicator	18	22	Image mode ²	56, 22
	b Battery charging indicator	13, 18	23	Edit comment.....	33
9	Protect icon.....	70, 41	24	Image added to the timeline.....	66
10	Wi-Fi ON/OFF	27, 88			
11	Share images.....	91			

¹ Icons displayed vary depending on the shooting mode.

² Icons displayed vary depending on the setting used for shooting.

Rotating the Monitor Display

The monitor display rotates automatically as shown below, depending on how the camera is oriented.

- The monitor display does not rotate during movie recording or playback.
- To prevent the monitor display from rotating automatically, go to **Display** in the Android OS setting menu (86), and tap **Auto-rotate screen** to remove the check mark.



Basic Steps for Shooting and Playback

Preparation 1 Insert the Battery

- 1 Open the battery-chamber cover.

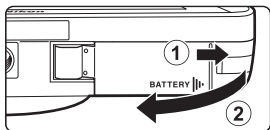

- 2 Insert the battery.

- Push the orange battery latch in the direction indicated by the arrow (①), and fully insert the battery (②).
- The battery locks into place when inserted correctly.

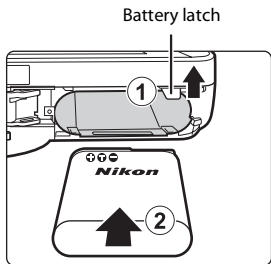

✔ Be Careful to Insert the Battery in Correct Direction

Inserting the battery upside down or backwards could damage the camera.



- 3 Close the battery-chamber cover.

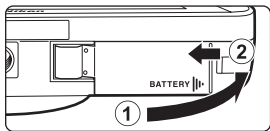

Removing the Battery

Turn the camera off and make sure that the power-on lamp and the monitor have turned off, and then open the battery-chamber cover.

Move the battery latch in the direction indicated by the arrow (①), to eject the battery (②).

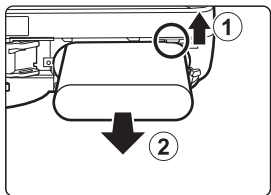

High Temperature Caution

The camera, battery, or memory card may be hot immediately after using the camera.

Preparation 2 Charge the Battery

1 Prepare the included Charging AC Adapter.

If a plug adapter* is included with your camera, attach the plug adapter to the plug on the Charging AC Adapter. Push the plug adapter firmly until it is securely held in place. Once the two are connected, attempting to forcibly remove the plug adapter could damage the product.

* The shape of the plug adapter varies depending on the country or region in which the camera was purchased. The Charging AC Adapter comes with the plug adapter attached in Argentina and Brazil.

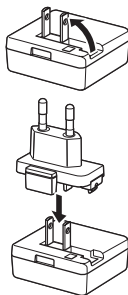

2 Make sure the battery is installed in the camera, and then connect the camera to the Charging AC Adapter in order of ① to ③.

- Make sure that the plugs are properly oriented. Do not insert or remove the plugs at an angle when connecting or disconnecting them.

Note

Do not use a USB cable other than the UC-E21. Using a USB cable other than the UC-E21 could result in overheating, fire or electric shock.

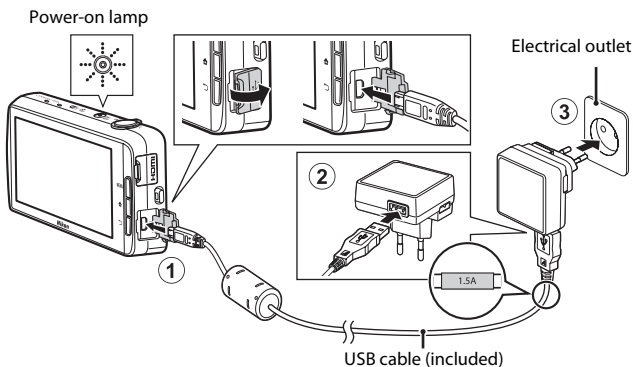

- The power-on lamp slowly flashes orange to indicate that the battery is charging.

Power-on lamp	Description
Glows/Flashes slowly (orange)	The battery is charging.
Off	When charging is complete, the power-on lamp stops flashing (orange) and turns off. About 3 hours 45 minutes are required to fully charge an exhausted battery.
Flashes quickly (orange)	<ul style="list-style-type: none"> • The ambient temperature is not suited to charging. Charge the battery indoors with an ambient temperature of 5°C to 35°C (41°F to 95°F). • The USB cable or Charging AC Adapter is not properly connected, or there is a problem with the battery. Disconnect the USB cable or unplug the Charging AC Adapter and correctly connect it again, or change the battery.

3 Disconnect the Charging AC Adapter from the electrical outlet, and then disconnect the USB cable.

Notes About Charging the Battery

- The camera can be operated while the battery is charging, but the charging time increases.
- If the battery level is extremely low, you may not be able to operate the camera while the battery is charging.
- If the battery is not inserted in the camera, you cannot charge the battery or operate the camera.
- Do not, under any circumstances, use another make or model of AC adapter other than Charging AC Adapter EH-71P, and do not use a commercially available USB-AC adapter or a battery charger for a mobile phone. Failure to observe this precaution could result in overheating or in damage to the camera.

Charging Using a Computer or Battery Charger

- You can also charge the battery by connecting the camera to a computer. However, the camera operations are limited when the USB storage option is turned on (📖95).
- The Battery Charger MH-67P (available separately; 📷72) can be used to charge the battery without using the camera.

Preparation 3 Insert a Memory Card

- 1 Turn off the camera and open the memory card slot cover.

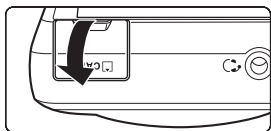

- 2 Insert the memory card.

- Slide the memory card in the correct orientation until it clicks into place.

Memory card slot

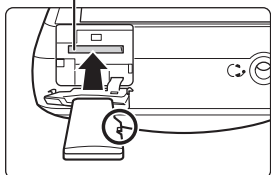

- ✓ Be Careful to Insert the Memory Card in Correct Direction**

Inserting the memory card upside down or backwards could damage the camera or the memory card.



- 3 Close the memory card slot cover.

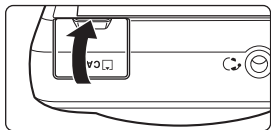

- ✓ Formatting a Memory Card**

The first time you insert a memory card that has been used in another device into this camera, make sure to format it with this camera. Insert the memory card into the camera, go to the Android OS setting menu (📖86), and select **Storage** followed by **Erase SD card**.

Removing the Memory Card

Turn the camera off and make sure that the power-on lamp and the monitor have turned off, and then open the memory card slot cover.

Gently push the memory card into the camera (①) to partially eject the card (②).

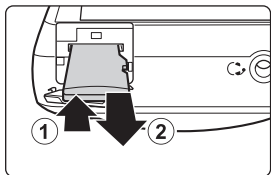

High Temperature Caution

The camera, battery, or memory card may be hot immediately after using the camera.

Internal Memory and Memory Cards

Camera data, including still images and movies, can be saved either in the camera's internal memory or on a memory card. To use the camera's internal memory, first remove the memory card.

Preparation 4 Configuring Various Settings

When you turn on the camera for the first time after purchase, the welcome screen is displayed. Follow the on-screen instructions to set each option.

- Some settings require you to enter text. See “Entering Text” (📖83) for more information about entering text.
- To set up a Wi-Fi (wireless LAN) connection, you must have access to a Wi-Fi (wireless LAN) network. Before configuring the Wi-Fi (wireless LAN) settings on the camera, make sure that your Wi-Fi (wireless LAN) network is set up and that you know your network SSID and password.
- You can also configure each setting at a later time.

1 Press the power switch to turn on the camera.

- The monitor turns on, and the welcome screen is displayed.

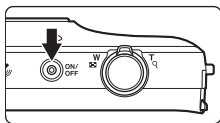

2 Select the language.

- Drag your finger up or down to scroll through the language list, select the desired language, and tap **Start**.

3 Configure the Wi-Fi (wireless LAN) settings.

- Tap the desired **SSID** (name of Wi-Fi (wireless LAN) network) in the list of available networks, enter the password, and tap **Connect**.
- Tap **Skip** to configure the setting later.
- When the connection is established, you can configure a Google™ account. Follow the on-screen instructions to set up the account.

4 Set the various options such as the date and time.

- Follow the on-screen instructions to set each option.
- If ◀▶ are displayed at the bottom of the monitor, tap ▶ to display the next screen and ◀ to return to the previous screen.
- When the settings are complete, the Android OS home screen is displayed. To begin shooting, activate the camera's shooting application by tapping 📷 (Shooting). See “Activating the Main Applications” (📖80) for more information.
- If you exit without setting the date and time, ⌚ will flash when the shooting screen is displayed. We recommend that you set the date and time before shooting (📖17).

Date & Time Settings





Press the  button →  Settings → Date & time

Configure the date and time settings on the Android OS setting menu (86).

Option	Description
Set date	Set camera clock to current date (month, day and year). <ul style="list-style-type: none"> • Drag each option up or down to specify the value, and tap Done.
Set time	Set camera clock to current time. <ul style="list-style-type: none"> • Drag each option up or down to specify the value, and tap Done.
Select time zone	Select your home time zone. <ul style="list-style-type: none"> • If you change the time zone after setting the time, the time that you set also changes.
Use 24-hour format	Select the 24-hour format display or 12-hour format display. <ul style="list-style-type: none"> • To select the 24-hour format display, add a check mark by tapping. • In some time displays such as the playback screen, 24-hour format is displayed regardless of the settings.
Choose date format	Specify the order of the displayed date.



Changing the Settings Later

- See “Language & input” (87) for more information about language settings.
- See “Setting Up a Wi-Fi (Wireless LAN) Network” (88) for more information.
- See “Setting Up a Google Account” (90) for more information.
- See “Date & Time Settings” (17) for more information.
- See “Location access” (86) for more information about setting the location information.



Clock Battery

- The camera’s clock is powered by a built-in backup battery. The backup battery charges when the main battery is inserted into the camera or when the camera is connected to an optional AC adapter, and it can run the clock for several days after about ten hours of charging.
- If the camera’s backup battery becomes exhausted, the welcome screen is displayed when the camera is turned on. Follow the on-screen instructions to reconfigure the settings. See “Preparation 4 Configuring Various Settings” (16) for more information.

Step 1 Turn the Camera On

1 Press the power switch.

- The monitor turns on and the shooting screen is displayed. You can start taking images immediately (📖19).
- Before proceeding to step 2, wait until the playback mode icon is displayed (📖19).
- For more information about turning the camera off, see “Step 7 Turn the Camera Off” (📖30).

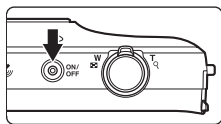

2 Check the battery level indicator and the number of exposures remaining.

Battery level indicator



Number of exposures remaining

Battery Level Indicator

Indicator	Description
	The battery level is high.
	The battery level is low. The indicator shows the remaining battery level in six steps.
	The battery is charging.
	The camera cannot capture images. Recharge the battery.

Number of Exposures Remaining

The number of images that can be taken is displayed.

- If a memory card is not inserted, **IN** is displayed to indicate that images are saved in the internal memory.

Taking Pictures Immediately After Turning on the Camera

When you turn on the camera, the monitor turns on and the shooting screen changes as shown below.



Immediately after monitor turns on.



Playback mode icon

- You can take images immediately after the monitor turns on.
- The availability of settings and the number of images that you can take are limited until the playback mode icon is displayed.

Step 2 Select a Shooting Mode

- 1 Tap the shooting mode icon.

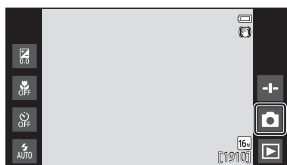

- 2 Tap the desired shooting mode icon.

-  (auto) mode is used in this example.
- The shooting mode setting is saved even after the camera is turned off.

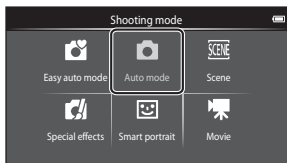

Available Shooting Modes



Easy auto mode

34

The camera automatically selects the optimum scene mode when you frame a picture, making it even easier to take images using settings that suit the scene.



Auto mode

35

Used for general shooting. Settings can be adjusted to suit the shooting conditions and the type of shot you want to capture.



Scene

37

When a shooting scene is selected, the camera settings are optimized to take images for that type of scene.



Special effects

42

Effects can be applied to images during shooting.



Smart portrait

44

When the camera detects a smiling face, you can take an image automatically without pressing the shutter-release button (smile timer). You can also use the skin softening option to smooth the skin tones of human faces.



Movie

72

Shoot movies with sound recorded via the built-in microphone.

Step 3 Frame a Picture

1 Hold the camera steadily in both hands.

- Keep fingers and other objects away from the lens, flash, AF-assist illuminator, microphone, and speaker.
- When taking pictures in portrait (“tall”) orientation, turn the camera so that the built-in flash is above the lens.

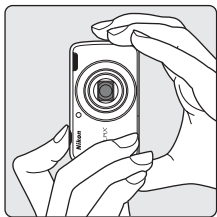
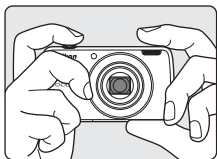

2 Frame the picture.



Using a Tripod

- We recommend using a tripod to stabilize the camera when shooting in the following situations:
 - When shooting in dim lighting
 - When shooting with the flash mode (📖48) set to ⚡ (Off)
 - When using the telephoto setting
- Set **Vibration reduction** to **Off** in the setup menu (📖77) to prevent potential errors caused by this function when using a tripod to stabilize the camera during shooting.

Using the Zoom

When you move the zoom control, the zoom lens position changes.

- To zoom in closer to the subject: Move toward **T** (telephoto).
- To zoom out and view a larger area: Move toward **W** (wide-angle).

When you turn the camera on, the zoom moves to the maximum wide-angle position.

- A zoom indicator is displayed at the top of the monitor when the zoom control is moved.
- Digital zoom allows you to magnify the subject up to approximately 4x beyond the maximum magnification of the optical zoom.

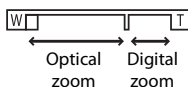
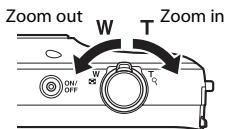

Notes About Digital Zoom

The zoom indicator turns blue when the digital zoom is activated, and it turns yellow when the zoom magnification is increased further.

- Zoom indicator is blue: Image quality is not noticeably reduced by using the Dynamic Fine Zoom.
- Zoom indicator is yellow: Image quality is noticeably reduced.
- The indicator remains blue across a wider area when the image size is smaller.

Step 4 Focus and Shoot

1 Press the shutter-release button halfway.

- When the subject is in focus, the focus area glows green (multiple focus areas can glow green).
- When digital zoom is used, the focus area is not displayed and the camera focuses in the center of the frame. Once focus is acquired, the focus indicator (📖6) glows green.
- If the focus area or the focus indicator flashes red, the camera is unable to focus. Modify the composition and try pressing the shutter-release button halfway again.

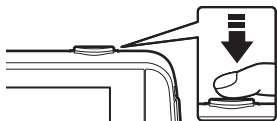

2 Without lifting your finger, press the shutter-release button the rest of the way down.





3 To add comments to the taken image, tap 🗨️.

- The screen for entering comments is displayed. See “Adding Comments to Images” (📖32) for more information.
- When you press the shutter-release button or when no operations are performed for about five seconds, the monitor display returns to the shooting screen.



The Shutter-release Button

<p>Press halfway</p> 	<p>To set focus and exposure (shutter speed and aperture value), press the shutter-release button lightly until you feel a slight resistance. Focus and exposure remain locked while the shutter-release button is pressed halfway.</p>
<p>Press all the way</p> 	<p>Press the shutter-release button all the way down to release the shutter and take an image. Do not use force when pressing the shutter-release button, as this may result in camera shake and blurred images. Press the button gently.</p>



Notes About Saving Images and Recording Movies

The indicator showing the number of exposures remaining or the indicator showing the maximum movie length flashes while images are being saved or while a movie is being recorded. **Do not open the battery-chamber cover or memory card slot cover or remove the battery or memory card** while an indicator is flashing. Doing this could result in loss of data, or in damage to the camera or the memory card.

Touch Shooting

The active focus area can be changed when using touch shooting. At the default setting, the shutter can be released by simply tapping a subject in the monitor (📖56) without pressing the shutter-release button.

Motion Detection

In  (easy auto) mode or  (auto) mode, when the camera detects subject movement or camera shake, ISO sensitivity and shutter speed are increased to reduce blurring. In this case, the shutter speed indicator turns green.

Imprinting the Shooting Date on Printed Images

- You can permanently imprint the shooting date on images as they are taken by setting **Print date** in the setup menu (📖77).
- You can use the ViewNX 2 software (📖96) to print the shooting date on images that were taken without using the **Print date** option.

Step 5 Play Back Images

- 1 Tap the playback mode icon.





- 2 Drag the current image to display the previous or next image.

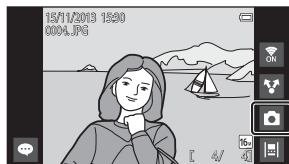

- Tap the shooting mode icon (📷) displayed at the bottom right of the monitor or press the shutter-release button to return to shooting mode.



Viewing Comments







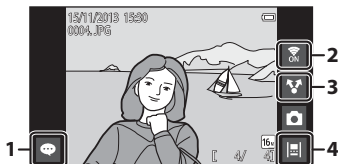

- If comments are added to an image, part of the comments are displayed at the bottom of the image ()24).
- Tap the comment area to display the entire comments.
- See “Adding Comments to Images” ()32) for more information.
- You can use ViewNX 2 to transfer and view images with comments on your computer ()97).



Operation Icons in Playback Mode

Tap the on-screen icon to perform the functions listed below.



Function	Description
 (Add comments)	Add comments to the current image ()33).
 (Wi-Fi ON/OFF)	Tap to switch Wi-Fi (wireless LAN) on/off. If you are connecting to a Wi-Fi (wireless LAN) network for the first time, you must configure the Wi-Fi (wireless LAN) settings ()88).
 (Share images)	Share the current image with other applications ()91).
 (Timeline view)	Display images in timeline view ()66).

Step 6 Delete Images

- 1 Play back an image to delete, and press the **MENU** button.

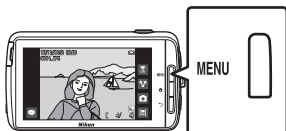

- 2 Tap .

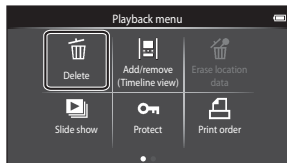

- 3 Tap the desired delete option.

- If step 1 and 2 are performed in thumbnail playback mode (65), select either **Select images** or **All images**.

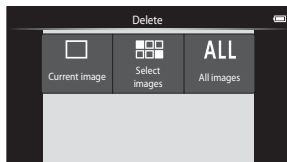

- 4 Tap **Yes**.

- Deleted images cannot be recovered.
- To cancel, tap **No**.

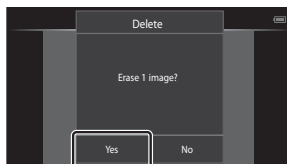

Operating the Erase Selected Images Screen

1 Tap an image to add ✓.

- To deselect an image, remove ✓ by tapping the image again.
- Drag the screen up or down to scroll through the images.
- To change the number of images displayed, move the zoom control or use your fingers to pinch or spread the screen, in the same way as with thumbnail playback mode (📖65).



2 Add ✓ to all images to delete and tap OK to apply the selection.

- The confirmation screen is displayed. Follow the on-screen instructions to complete the operation.

✓ Notes About Deleting Images

- If you press the 🏠 button while the camera is deleting images, the deletion process stops and the Android OS home screen is displayed. Do not perform any operations until the message disappears.
- Images added to the timeline cannot be deleted (📖66). Remove images from the timeline in order to delete them.

Step 7 Turn the Camera Off

1 Press and hold the power switch for several seconds.

- If the monitor is already off, the camera has entered power saving mode (📖31). Before turning the camera off, press the power switch once to exit power saving mode and turn the monitor back on.

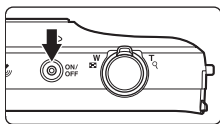

- If you press the power switch once without holding it down, the camera enters stand by mode (📖31), and the monitor turns off.

2 Select how the camera turns off.

- **Prepare for quick start** (default setting): The status of the camera is saved before turning off. The camera starts up quickly the next time you turn it on.
- **Quick power off**: The camera turns off immediately.

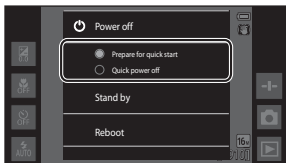

3 Tap **Power off**.

- The camera turns off using the option selected in step 2.
- If you tap **Stand by** on this screen, the camera enters stand by mode.

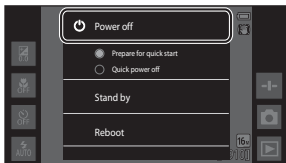



✓ **Notes About Using Stand By Mode and Turning the Camera Off**

- Unsaved data is lost when the camera turns off. Save the data that you want to keep before the camera enters stand by mode, or before turning off the camera.
- You cannot use stand by mode or turn off the camera while the USB storage option is turned on (📖95).

Power Saving Function

By default, the camera reduces power consumption by automatically entering the modes listed below.

Mode	Level	Description
Display off	Medium	<p>If no operations are performed for a while when the camera is on, the monitor turns off automatically and battery power consumption is reduced.¹ The power-on lamp glows green in this mode.²</p> <ul style="list-style-type: none"> To turn the monitor back on, press the power switch, MENU button,  button or  button. The camera enters stand by mode if no further operations are performed for 1 minute.³
Stand by mode	High	<p>Each function enters stand by mode and battery power consumption is greatly reduced. The power-on lamp flashes green in this mode.²</p> <ul style="list-style-type: none"> To turn the camera back on, press the power switch. The camera turns off if no further operations are performed (Shut-down timer⁴).
Power off	Maximum	<p>Almost no battery power is consumed, but it takes a longer time to turn on the camera.</p>

¹ You can change the amount of time that elapses before the camera enters display off mode (86). The default setting is 1 minute.

² The power-on lamp glows orange while the battery is charging (13).

³ The camera cannot enter stand by mode while the USB storage option is turned on (95).

⁴ You can change the amount of time that elapses before the camera turns off (86). The default setting is 1 hour. However, the camera cannot be turned off while the battery is charging.

Power Saving Tips

Turn off functions that are not in use to reduce battery power consumption. The quick settings on the Android OS home screen make it easy to adjust monitor brightness, turn on/off the Wi-Fi function, etc. (81).

Adding Comments to Images

Adding Comments when Shooting

You can add comments, such as your impressions or other information about an image, immediately after the shutter is released (except for continuous shooting).

1 Tap on the screen that is displayed immediately after taking a picture.

- To return to shooting mode, press the shutter-release button or wait about five seconds without performing any operations.
- When a setting other than **On (comment)** is selected for **Image review** in **Monitor settings** in the setup menu (📖77), the screen that is shown on the right is not displayed.



2 Enter text using the on-screen keyboard.

- You can also use your voice to enter text.
- For more information about using the keyboard or voice typing, see “Entering Text” (📖83).

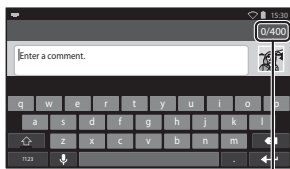

Number of input characters/maximum number of input characters

3 Tap at the top left of the screen to finish entering text.

- The comments are saved and the shooting screen is displayed.

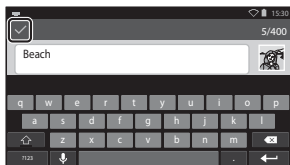

Notes About Taking Images of Human Subjects

Comments cannot be added immediately after taking an image if the camera detects that a human subject may have blinked (📖77). Play back the image to add comments.

Adding Comments when Playing Back

Tap  on the playback screen to display the screen shown in step 2 of “Adding Comments when Shooting” (32). To add comments, follow the same procedure as for when shooting.

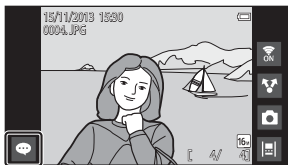

Viewing/Editing Comments

You can view or edit comments that were added to images during shooting or playback.

1 View the image with comments in full-frame playback mode.



- Images that include comments are shown with part of the comments displayed at the bottom of the image.

2 Tap the comment area.

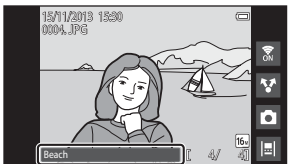
- The entire comments are displayed. If the full text does not fit on the screen, drag the comment area up or down to display the hidden portion.
- Tap the comment area (or  at the top of the comment area) to return to full-frame playback mode.







3 Tap or to edit or delete comments.

-  (Edit): Enter text in the same way as when you added the comments to the image, tap , and tap **Yes** on the confirmation screen (32).
-  (Delete): Tap **Yes** on the confirmation screen. Only the comments are deleted.



Notes About Entering Comments





The entered comments are not saved until you tap . If you accidentally press the shutter-release button,  button, or  button, the comments will be canceled without being saved. If you press the  button while entering comments in playback mode, you can select the playback application again and return to the comment entry screen.

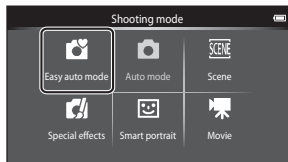
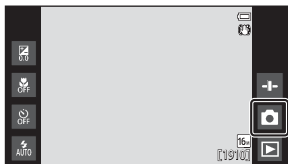

Shooting Features

(Easy Auto) Mode

The camera automatically selects the optimum scene mode listed below when you frame a picture, making it even easier to take images using settings that suit the scene.



-  : Portrait
-  : Landscape
-  : Night portrait
-  : Night landscape

-  : Close-up
-  : Backlighting
-  : Other shooting scenes

- The focus area selected by the camera varies depending on the automatically selected scene mode. If a human face is detected, the camera focuses on it. See "Face Detection" (61) for more information.
- The active focus area can be changed when using touch shooting (56).
- In easy auto mode, the camera may not select the desired scene mode under some shooting conditions. If this happens, select a different shooting mode.
- When digital zoom is in effect,  is selected as the shooting scene.

(Auto) Mode

Used for general shooting. Settings can be adjusted to suit the shooting conditions and the type of shot you want to capture.













- The focus area selected by the camera varies depending on the **AF area mode** setting (📖56). The default setting is **Target finding AF** (📖60).
- The active focus area can be changed when using touch shooting (📖56). The **Subject tracking** option, which moves the active focus area to track the registered subject, can be enabled.

Functions Available in (Auto) Mode

- Creative slider (📖36)
- Flash mode (📖47)
- Self-timer (📖49)
- Macro mode (📖51)
- Exposure compensation (📖52)
- Shooting menu (📖55)

Adjusting Creative Slider

Tap  in  (auto) mode to display the creative slider.

- Tap or drag the slider to adjust the vividness or hue.
 - Tap  to display the vividness adjustment screen. After the vividness is adjusted,  is displayed on the shooting screen (7).
 - Tap  to display the hue adjustment screen. After the hue is adjusted,  is displayed on the shooting screen (7). If the hue is adjusted, the white balance is changed and **White balance** (56) cannot be set in the shooting menu.
- Tap  to restore the default values and display the vividness adjustment screen.
- After you finish making the adjustment, tap  to hide the creative slider.

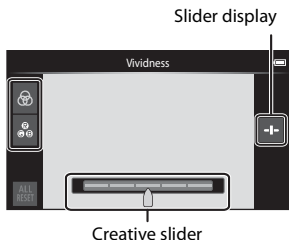

Scene Mode (Shooting Suited to Scenes)

When a scene is selected, the camera settings are automatically optimized for the selected scene.

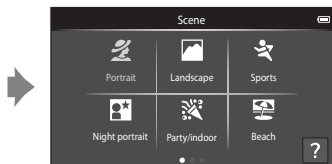
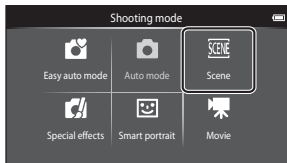
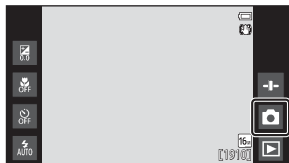

- To select a scene, tap the desired scene icon on the screen shown on the left.
- To display the previous or next option, flick the screen to the left or right.

Portrait	Landscape ¹
Sports ^{2,3} (📖39)	Night portrait ⁴ (📖39)
Party/indoor ^{2,3} (📖39)	Beach ^{2,3}
Snow ^{2,3}	Sunset ^{2,4}
Dusk/dawn ^{1,4}	Night landscape ^{1,4}
Close-up ^{2,3} (📖39)	Food ^{2,3} (📖39)
Fireworks show ^{1,4} (📖39)	Black and white copy ^{2,3} (📖39)
Backlighting ^{2,3} (📖40)	Easy panorama ² (📖40)
Pet portrait (📖41)	

¹ The camera focuses at infinity.

² The camera focuses on the area in the center of the frame.

³ The active focus area can be changed when using touch shooting (📖56).

⁴ Use of a tripod is recommended, because the shutter speed is slow. Set **Vibration reduction to Off** in the setup menu (📖77) when using a tripod to stabilize the camera during shooting.

Viewing a Description (Help Information) of Each Scene

When **?** is tapped on the scene selection screen, the help selection screen is displayed. Tap a scene icon to display a description of that scene. To return to the previous screen, tap **OK** or press the **↶** button.

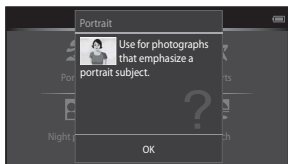

Adjusting Scene Effect

The scene effect adjustment slider is displayed by tapping **+** in the scene modes listed below.

- Tap or drag the scene effect adjustment slider to adjust the degree of effect to be applied to images taken in the selected scene mode.
- After you finish making the adjustment, tap **+** to hide the scene effect adjustment slider.

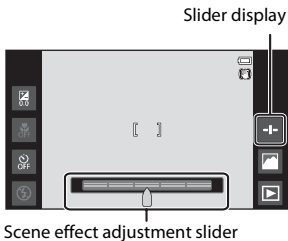



Food	<p>More blue More red</p>
Landscape, Close-up	<p>Less vivid More vivid</p>
Sunset, Dusk/dawn	<p>More blue More red</p>

The changes made to the scene effects are stored in the camera's memory even after the camera is turned off.

Tips and Notes

Sports

- While the shutter-release button is held all the way down, the camera shoots up to about 3 images continuously at a rate of about 8 fps (when image mode is set to ).
- The frame rate with continuous shooting may vary depending on the current image mode setting, the memory card used, or shooting conditions.
- During continuous shooting, focus, exposure, and hue are fixed at the values determined with the first image in each series.
- Continuous shooting is disabled and only one image can be taken at a time when the shutter is released using the touch shutter function (56).

Night portrait

- The flash always fires.

Party/indoor

- Hold the camera steadily. If you use a tripod to stabilize the camera, set **Vibration reduction** to **Off** in the setup menu (77).

Close-up

- Macro mode (51) is enabled and the zoom automatically moves to the possible closest shooting position.

Food

- Macro mode (51) is enabled and the zoom automatically moves to the possible closest shooting position.

Fireworks show

- The shutter speed is fixed to four seconds.
- The zoom is restricted to four fixed positions.





Black and white copy

- Use with macro mode (51) when shooting a subject at close distance.

Backlighting

- Press the **MENU** button and tap **HDR HDR** to enable or disable the HDR (high dynamic range) function.
- **OFF Off** (default setting): The flash fires to prevent the subject from being hidden in shadow.
 - When the shutter-release button is pressed all the way down, one image is taken.
- **ON On**: HDR processing is applied (useful when taking images with very bright and dark areas in the same frame).
 - When the shutter-release button is pressed all the way down, the camera takes images continuously at high speed, and saves the following 2 images.
 - A non-HDR composite image
 - An HDR composite image in which the loss of details in highlights or shadows is minimized
 - If there is only enough memory to save one image, an image processed by D-Lighting (70) at the time of shooting, in which dark areas of the image are corrected, is the only image saved.
 - Once the shutter-release button is pressed all the way down, hold the camera and do not move it until a still image is displayed on the shooting screen. After taking an image, do not turn the camera off before the monitor switches to the shooting screen.
 - The angle of view (i.e., the area visible in the frame) seen in the saved image is narrower than that seen in the monitor at the time of shooting.



Easy panorama

- Press the **MENU** button and tap  **Easy panorama** to select the shooting range from  **Normal (180°)** (default setting) or  **Wide (360°)**.
- The zoom position is fixed at wide-angle.
- Press the shutter-release button all the way down, remove your finger from the button, and then slowly pan the camera across the scene. Shooting ends when the camera captures the specified shooting range.
- Focus and exposure are locked when shooting starts.
- If you tap  when a taken image is displayed in full-frame playback mode, the image scrolls automatically.
- The images cannot be edited on this camera.
See “Using Easy Panorama (Shooting and Playback)” (2) for more information.

Notes About Printing Panoramas

The entire image may not be able to be printed depending on the printer's settings. Additionally, printing may not be possible depending on the printer.

Pet portrait

- When you point the camera at a dog or cat, the camera detects the pet's face and focuses on it. By default, the shutter is automatically released when focus is acquired (pet portrait auto release).
- Press the **MENU** button and tap  **Continuous** and then select **Single** or **Continuous**.
 -  **Single**: Whenever the detected face is in focus, the camera captures one image.
 -  **Continuous** (default setting): Whenever the detected face is in focus, the camera captures three images continuously.

Notes About Pet Portrait Auto Release

- To change the setting, press the **MENU** button and select  **Pet portrait auto release**.
 - **ON On** (default setting): The camera detects a dog or cat face and automatically releases the shutter when the detected face is in focus.
 - **OFF Off**: The camera does not release the shutter automatically, even if a dog or cat face is detected. Press the shutter-release button. The camera also detects human faces when **Off** is selected.
- **Pet portrait auto release** is set to **Off** after five bursts have been taken.
- Shooting is also possible by pressing the shutter-release button, regardless of the **Pet portrait auto release** setting. When **Continuous** is selected, you can take images continuously while holding down the shutter-release button all the way.

AF Areas

- When the camera detects a face, the face is displayed inside a yellow border. When the camera acquires focus on a face displayed inside a double border (focus area), the double border turns green. If no faces are detected, the camera focuses on the subject in the center of the frame.
- Under some shooting conditions, the camera may not be able to detect the pet's face, or other subjects may be framed by a border.

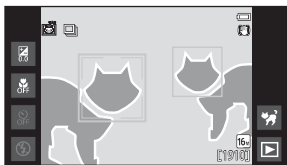



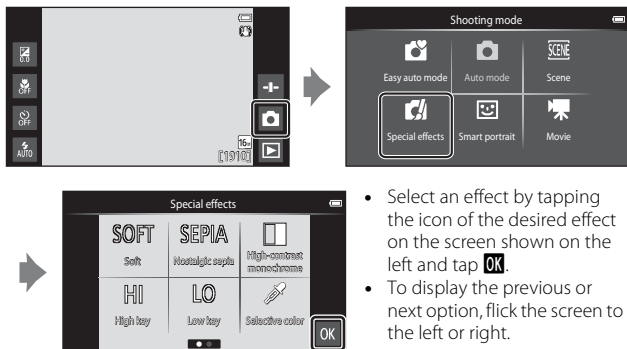

Special Effects Mode (Applying Effects When Shooting)

Effects can be applied to images during shooting.



- Select an effect by tapping the icon of the desired effect on the screen shown on the left and tap **OK**.
- To display the previous or next option, flick the screen to the left or right.

Category	Description
SOFT Soft (default setting)	Softens the image by adding a slight blur to the entire image.
SEPIA Nostalgic sepia	Adds a sepia tone and reduces the contrast to simulate the qualities of an old photograph.
 High-contrast monochrome	Changes the image to black and white and gives it sharp contrast.
HI High key	Gives the entire image a bright tone.
LO Low key	Gives the entire image a dark tone.
 Selective color	Creates a black and white image in which only the specified color remains.
 Cross process	Gives the image a mysterious appearance based on a specific color.
POP Pop	Increases the color saturation of the entire image to create a bright look.
VI Super vivid	Increases the color saturation of the entire image and sharpens the contrast.

Category	Description
 Toy camera effect 1	Gives the entire image a yellowish hue and darkens the image periphery.
 Toy camera effect 2	Decreases the color saturation of the entire image and darkens the image periphery.

- The camera selects one or more of nine focus areas containing the subject closest to the camera.
- The active focus area can be changed when using touch shooting (📖 56).
- When **Selective color** or **Cross process** is selected, tap or drag the slider to select the desired color from the slider. Tap  to display/hide the slider.

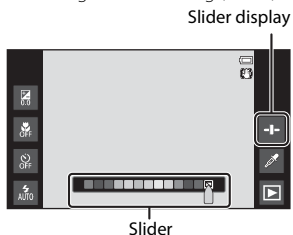

Smart Portrait Mode (Shooting Smiling Faces)

When the camera detects a smiling face, you can take an image automatically without pressing the shutter-release button (smile timer (📖56)). You can also use the skin softening option to smooth the skin tones in human faces.

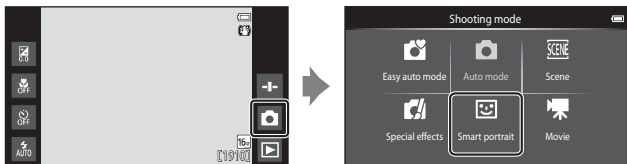

1 Frame the picture.

- Point the camera at a human face.

2 Without pressing the shutter-release button, wait for the subject to smile.

- If the camera detects that the face framed by the double border is smiling, the shutter is automatically released.
- Whenever the camera detects a smiling face, it automatically releases the shutter.

3 End automatic shooting.

- Perform one of the operations listed below to end shooting.
 - Set **Smile timer** to **Off**.
 - Tap the shooting mode icon and select a different shooting mode.

✓ **Notes About Smart Portrait Mode**

Under some shooting conditions, the camera may be unable to detect faces or smiles (📖61). The shutter-release button can also be used for shooting.

📌 **Self-timer Lamp**

The self-timer lamp flashes slowly when the smile timer is enabled and the camera detects a face, and it flashes quickly immediately after the shutter is released.

Functions Available in Smart Portrait Mode

- Flash mode (📖47)
- Self-timer (📖49)
- Exposure compensation (📖52)
- Smart portrait menu (📖55)

Basic Shooting Settings

Depending on shooting mode, you can set the following functions by tapping the icons at the left of the monitor. When the icons are hidden, tap **DISP.**



				SCENE			
1	Flash mode (📖47)	✓	✓	*	✓	✓*	—
2	Self-timer (📖49)	✓	✓		✓	✓*	✓
3	Macro mode (📖51)	—	✓		✓	—	✓
4	Exposure compensation (📖52)	✓	✓		✓	✓	✓

* Availability depends on the setting.

Using the Flash

You can set flash mode to match the shooting conditions.

- 1 Tap the flash mode icon.



- 2 Tap the desired flash mode icon (📖48) to select it.

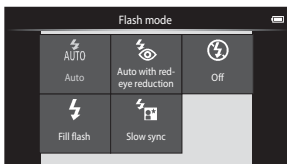

✓ The Flash Indicator

The flash indicator shows flash status when the shutter-release button is pressed halfway.

- On: The flash fires when the shutter-release button is pressed all the way down.
- Flashing: The flash is charging. Wait a few seconds and try again.
- Off: The flash does not fire. The flash mode icon is not displayed.

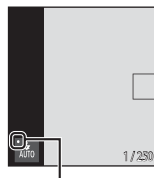

Flash indicator

Available Flash Modes



Auto

The flash fires when necessary, such as in dim lighting.



Auto with red-eye reduction

Reduce red-eye in portraits caused by the flash.



Off

The flash does not fire. We recommend using a tripod to stabilize the camera when shooting in dark surroundings.



Fill flash

The flash fires whenever an image is taken. Use to “fill-in” (illuminate) shadows and back-lit subjects.



Slow sync

Suited to evening and night portraits that include background scenery. The flash fires when necessary to illuminate the main subject; slow shutter speeds are used to capture background at night or under dim lighting.



Flash Mode Setting

- The setting may not be available with some shooting modes.
- The setting applied in  (auto) mode is saved in the camera's memory even after the camera is turned off.



Red-eye Reduction

To reduce red-eye, a series of low-intensity pre-flashes fire before the main flash. In addition, if the camera detects red-eye when an image is taken, the affected area is processed to reduce red-eye before the image is saved. Note the following when shooting:

- Due to the pre-flashes, there is a longer than usual interval between the time the shutter-release button is pressed and the time the shutter is released.
- More time than usual is required to save images.
- Red-eye reduction may not produce the desired results in some situations.
- In extremely rare instances, areas not subject to red-eye may be affected by red-eye reduction processing; in these cases, select another flash mode and try again.

Using the Self-timer

The camera is equipped with a self-timer that releases the shutter about ten seconds or two seconds after you press the shutter-release button.

Set **Vibration reduction** to **Off** in the setup menu (📖77) when using a tripod to stabilize the camera.

1 Tap the self-timer icon.

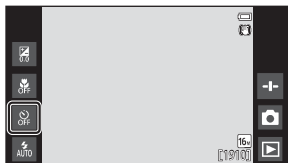

2 Tap **10s** or **2s**.

- **10s 10 s**: Use on important occasions, such as weddings.
- **2s 2 s**: Use to prevent camera shake.

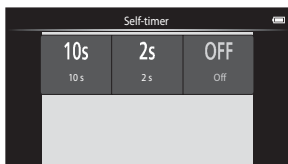

3 Frame the picture and press the shutter-release button halfway.

- Focus and exposure are locked.



4 Press the shutter-release button the rest of the way down.

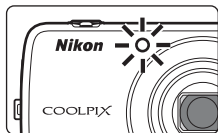
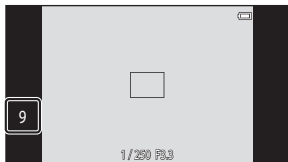

- Countdown starts. The self-timer lamp flashes while the timer is counting down. About 1 second before the shutter is released, the lamp stops flashing and glows steadily.
- When the shutter is released, the self-timer turns off.
- To stop the countdown, press the shutter-release button again.

Using Macro Mode

Use macro mode when taking close-up images.

- 1 Tap the macro mode icon.



- 2 Tap ON.

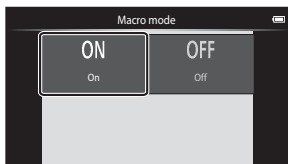

- 3 Move the zoom control to set the zoom ratio to a position where  and the zoom indicator glow green.



- When the zoom ratio is set to a position where the zoom indicator glows green, the camera can focus at subjects as close as approximately 10 cm (4 in.) from the lens. When the zoom is at the position where  is displayed, the camera can focus on subjects as close as approximately 2 cm (0.8 in.) from the lens.

Notes About Using the Flash

The flash may be unable to light the entire subject at distances of less than 50 cm (1 ft 8 in.).

Macro Mode Setting

- The setting may not be available with some shooting modes.
- The setting applied in  (auto) mode is saved in the camera's memory even after the camera is turned off.

Adjusting Brightness (Exposure Compensation)

Adjust overall image brightness.

- 1 Tap the exposure compensation icon.



- 2 Tap or drag the slider to change the exposure compensation value, and tap **OK**.

- To brighten the image, set a positive (+) value.
- To darken the image, set a negative (-) value.
- The compensation value is applied, even without tapping **OK**.

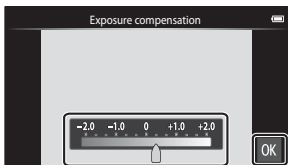































Exposure Compensation Value

The setting applied in  (auto) mode is saved in the camera's memory even after the camera is turned off.

Default Settings

The default settings for each function in each shooting mode are described below.

	Flash mode ( 47)	Self-timer ( 49)	Macro mode ( 51)	Exposure compensation ( 52)
 (easy auto)	 ¹ AUTO	Off	Off ²	0.0
 (auto)	 AUTO	Off	Off	0.0
 (special effects)	 AUTO	Off	Off	0.0
 (smart portrait)	 AUTO	Off	Off ³	0.0
 (movie)	 ³	Off	Off	0.0
Scene				
 (Portrait)		Off	Off ³	0.0
 (Landscape)	 ³	Off	Off ³	0.0
 (Sports)	 ³	Off ³	Off ³	0.0
 (Night portrait)	 ⁴	Off	Off ³	0.0
 (Party/indoor)	 ⁵	Off	Off ³	0.0
 (Beach)	 AUTO	Off	Off ³	0.0
 (Snow)	 AUTO	Off	Off ³	0.0
 (Sunset)	 ³	Off	Off ³	0.0
 (Dusk/dawn)	 ³	Off	Off ³	0.0
 (Night landscape)	 ³	Off	Off ³	0.0
 (Close-up)		Off	On ³	0.0
 (Food)	 ³	Off	On ³	0.0
 (Fireworks show)	 ³	Off ³	Off ³	0.0 ³
 (Black and white copy)		Off	Off	0.0
 (Backlighting)	 ⁶ /  ⁶	Off	Off ³	0.0
 (Easy panorama)	 ³	Off ³	Off ³	0.0
 (Pet portrait)	 ³	Off ³	Off	0.0

- 1  (Auto) (default setting) or  (Off) can be selected. When  (Auto) is selected, the camera automatically selects the flash mode appropriate for the scene it has selected.
- 2 The setting cannot be changed. The camera enters macro mode when  is selected.
- 3 Cannot be changed.
- 4 Cannot be changed. The flash mode setting is fixed at fill flash with red-eye reduction.
- 5 The setting may change to slow sync with red-eye reduction.
- 6 The flash is fixed at  (Fill flash) when **HDR** is set to **Off**, and is fixed at  (Off) when **HDR** is set to **On**.

Functions That Can Be Set with the MENU Button (Shooting Menu)

When shooting images in shooting mode, you can set the menu options listed below by pressing the **MENU** button (📖3).























The settings that can be changed vary depending on shooting mode, as indicated below.

Image mode ¹	✓	✓	✓	✓	✓
Touch shooting	✓	✓	✓	✓	✓
ISO sensitivity	-	✓	-	-	-
Continuous	-	✓	-	-	-
White balance	-	✓	-	-	-
AF area mode	-	✓	-	-	-
Skin softening	-	-	-	-	✓
Blink proof	-	-	-	-	✓
Smile timer	-	-	-	-	✓

¹ The setting is also applied to other shooting modes.

² Additional options can be set for some scene mode settings. See “Tips and Notes” (📖39) for more information.

Shooting Menu Options

Option	Description	
 Image mode	Allows you to set the combination of image size and image quality used when saving images. <ul style="list-style-type: none"> • Default setting:  4608x3456. 	 22
 Touch shooting	Select between Touch shutter (default setting), which allows you to release the shutter by tapping the monitor, and Touch AF/AE , which allows you to set the focus area by tapping the monitor. Subject tracking can be set in  (auto) mode.	 23
ISO ISO sensitivity	Allows you to set the camera's ISO sensitivity according to the brightness of the subject. <ul style="list-style-type: none"> • Default setting: Auto When Auto is selected, ISO is displayed in the monitor while shooting if ISO sensitivity increases. 	 29
 Continuous	Allows you to select single or continuous shooting. <ul style="list-style-type: none"> • Default setting: Single 	 30
WB White balance	Allows you to adjust white balance to suit the weather conditions or light source in order to make the colors in images match what you see with your eyes. <ul style="list-style-type: none"> • Default setting: Auto 	 32
 AF area mode	Allows you to determine how the camera selects the focus area that is used for autofocus. <ul style="list-style-type: none"> • Default setting: Target finding AF ( 60) 	 34
 Skin softening	Allows you to select the skin softening level for human faces. <ul style="list-style-type: none"> • Default setting: Normal 	 36
 Blink proof	The camera automatically releases the shutter twice with every shot and saves one image in which the subject's eyes are open. <ul style="list-style-type: none"> • Default setting: Off 	 37
 Smile timer	Allows you to select whether or not the camera automatically releases the shutter when it detects a human smiling face. <ul style="list-style-type: none"> • Default setting: On (single) 	 38

Functions That Cannot Be Used Simultaneously

Some shooting settings cannot be used with other functions.

Restricted function	Setting	Description
Flash mode (📖47)	Continuous (📖56)	When a setting other than Single is selected, flash is disabled.
	Blink proof (📖56)	When Blink proof is set to On , flash is disabled.
	Smile timer (📖56)	When On (continuous) or On (BSS) is selected, the flash is disabled.
Self-timer (📖49)	Touch shooting (📖56)	When Subject tracking is selected, the self-timer is disabled.
	Smile timer (📖56)	When a setting other than Off is selected, the selftimer is disabled.
Macro mode (📖51)	Touch shooting (📖56)	When Subject tracking is selected, macro mode is disabled.
Image mode (📖56)	Continuous (📖56)	<p>Image mode is locked for each continuous shooting setting, as follows:</p> <ul style="list-style-type: none"> • Continuous H: 120 fps: VGA (image size: 640 × 480 pixels) • Continuous H: 60 fps: 1M (image size: 1280 × 960 pixels) • Multi-shot 16: 5M (image size: 2560 × 1920 pixels)
Touch shooting (📖56)	Smile timer (📖56)	When Smile timer is used for shooting, Touch shooting is disabled.
	Pet portrait auto release (📖41)	When Pet portrait auto release is used for shooting, Touch shooting is disabled.

Restricted function	Setting	Description
ISO sensitivity (📖56)	Continuous (📖56)	When Continuous H: 120 fps , Continuous H: 60 fps , or Multi-shot 16 is selected, the ISO sensitivity setting is automatically specified according to the brightness.
		When Continuous L is selected, 3200 cannot be selected. If Continuous L is selected when the ISO sensitivity setting is 3200 , the ISO sensitivity setting changes to 1600 .
Continuous (📖56)	Touch shutter (📖56)	When a setting other than Multi-shot 16 is selected, one image is taken each time the monitor is tapped when using the touch shutter function.
White balance (📖56)	Creative slider (📖36)	When hue is adjusted, White balance is fixed at Auto .
AF area mode (📖56)	Creative slider (📖36)	If the creative slider is adjusted when Target finding AF is selected, the camera does not detect the main subject.
	Touch shooting (📖56)	When Touch shooting is set to Subject tracking , AF area mode is disabled.
	White balance (📖56)	When a setting other than Auto is selected for White balance in Target finding AF mode, the camera does not detect the main subject.
Blink proof (📖56)	Smile timer (📖56)	When Blink proof is set to On , it changes to Off if Smile timer is set to On (continuous) or On (BSS) .
Smile timer (📖56)	Blink proof (📖56)	When Smile timer is set to On (continuous) or On (BSS) , it changes to On (single) if Blink proof is set to On .

Restricted function	Setting	Description
Print date (📖77)	Continuous (📖56)	When a setting other than Single or Multi-shot 16 is selected, Print date is disabled.
	Blink proof (📖56)	When Blink proof is set to On , the date and time cannot be imprinted on images.
	Smile timer (📖56)	When Smile timer is set to On (continuous) or On (BSS) , the date and time cannot be imprinted on images.
Digital zoom (📖77)	Continuous (📖56)	When Multi-shot 16 is selected, digital zoom is not available.
	Touch shooting (📖56)	When Subject tracking is selected, the digital zoom is disabled.
Shutter sound (📖77)	Continuous (📖56)	When a setting other than Single is selected, the shutter sound is disabled.
Blink warning (📖77)	Continuous (📖56)	When a setting other than Single is selected, Blink warning is disabled.

✓ Notes About Digital Zoom

- Depending on the shooting mode or the current settings, digital zoom may not be available (📖56).
- The camera focuses on the subject at the center of the frame when digital zoom is in effect.

Focusing on Subjects

The focus area varies depending on the shooting mode.

Using Target Finding AF

When **AF area mode** (📖56) in 📷 (auto) mode is set to **Target finding AF**, the camera focuses in the manner described below when you press the shutter-release button halfway.

- The camera detects the main subject and focuses on it. When the subject is in focus, the focus area glows green. If a human face is detected, the camera automatically sets focus priority on it. See “Face Detection” (📖61) for more information.

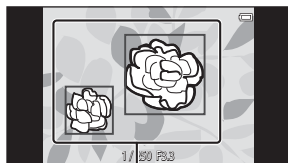

Focus areas

- If no main subject is detected, the camera automatically selects one or more of the nine focus areas containing the subject closest to the camera. When the subject is in focus, the focus areas that are in focus glow green.

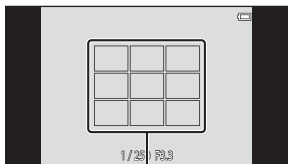



Focus areas

✓ Notes About Target Finding AF

- Depending on shooting conditions, the subject that the camera determines to be the main subject may vary.
- The camera may not detect the main subject when the creative slider is adjusted or when using certain **White balance** settings.
- The camera may not detect the main subject appropriately in the following situations:
 - When the subject is very dark or bright
 - When the main subject lacks clearly defined colors
 - When the shot is framed so that the main subject is at the edge of the monitor
 - When the main subject is composed of a repeating pattern



Face Detection

When the camera is pointed at a human face in the shooting modes listed below, the camera automatically detects the face and focuses on it.

-  (easy auto) (📖34)
- When **AF area mode** (📖56) in  (auto) mode (📖35) is set to **Face priority** or **Target finding AF**.
- **Portrait**, or **Night portrait** scene mode (📖37)
- Smart portrait mode (📖44)

When the camera detects more than one face, the double border (focus area) is displayed around the face that is focused on, and single borders around the others.

If the shutter-release button is pressed halfway when no faces are detected:

- In  (easy auto) mode, the camera changes focus areas depending on the scene.
- In  (auto) mode, the camera selects the focus area containing the subject closest to the camera (when using **Face priority**).
- In **Portrait** and **Night portrait** scene modes or smart portrait mode, the camera focuses on the subject at the center of the frame.



Notes About the Face Detection Function

- The camera's ability to detect faces depends on a variety of factors, including the direction in which the faces are looking.
- The camera may be unable to detect faces in the following situations:
 - When faces are partially hidden by sunglasses or other obstructions
 - When faces take up too much or too little of the frame

Skin Softening

When the shutter is released while using one of the shooting modes listed below, the camera detects human faces and processes the image to soften facial skin tones (up to three faces).

- Smart portrait mode (📖44)
 - The skin softening level can be adjusted.
- **Portrait** or **Night portrait** scene mode (📖37)
 - This includes cases where the camera selects one of these scene modes while in 📷 (easy auto) mode.

Skin softening can also be applied to saved images (📖70).

✔ Notes About Skin Softening

- More time than usual may be required to save an image.
- Under some shooting conditions, facial skin tones may not be smoothed or parts other than face may be modified.

Subjects Not Suitable for Autofocus

Autofocus may not perform as expected in the following situations. In some rare cases, the subject may not be in focus despite the fact that the focus area or the focus indicator glows green:

- Subject is very dark
- Objects of sharply differing brightness are included in the scene (e.g. the sun behind the subject makes that subject appear very dark)
- No contrast between the subject and surroundings (e.g. a portrait subject wearing a white shirt is standing in front of a white wall)
- Several objects are at different distances from the camera (e.g. the subject is inside a cage)
- Regular geometric patterns (e.g. window blind or windows on a skyscraper)
- Subject is moving rapidly

In the situations noted above, try pressing the shutter-release button halfway to refocus several times, or try focusing on another subject that is at the same distance from the camera as the intended subject (📖63).

Focus Lock

Focus lock shooting is recommended when the camera does not activate the focus area that contains the desired subject.

1 Set **AF area mode** to **Center** in  (auto) mode (56).

2 Position the subject in the center of the frame and press the shutter-release button halfway.

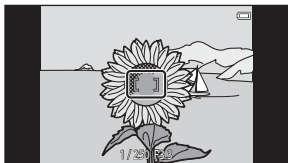

- The camera focuses on the subject and the focus area glows green.
- Focus and exposure are locked.

3 Without lifting your finger, recompose the picture.

- Make sure to maintain the same distance between the camera and the subject.



4 Press the shutter-release button the rest of the way down to take the picture.



Playback Features

Playback Zoom

Spread two fingers apart in full-frame playback mode (📖26) to enlarge the current image.

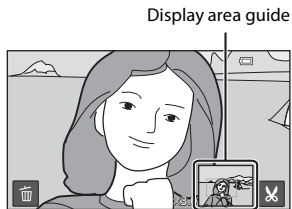
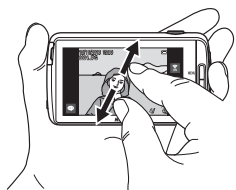

Image is zoomed in.

- You can also zoom in on images by moving the zoom control toward **T** (🔍) or double-tapping an image.
- The zoom ratio changes as your fingers move (spreading apart or pinching together). You can also change the zoom ratio by moving the zoom control (**T** (🔍)/**W** (📐)).
- To view a different area of the image, drag the image.
- If you move the zoom control to zoom in on an image that was taken using face detection (except for target finding AF) or pet detection, the camera zooms in on the face detected at the time of shooting (except images captured in a series). If the camera detected multiple faces when the image was captured, tap 🗑️ or 🗑️ to display a different face.
- To delete images, tap 🗑️.
- When a zoomed image is displayed, double-tap the image to return to full-frame playback mode.

Cropping Images

When a zoomed image is displayed, tap ✂️ to crop the image and save the displayed area of the image as a separate file (📷13).

Thumbnail Playback

Pinch two fingers together in full-frame playback mode (📖26) to display images as thumbnails.

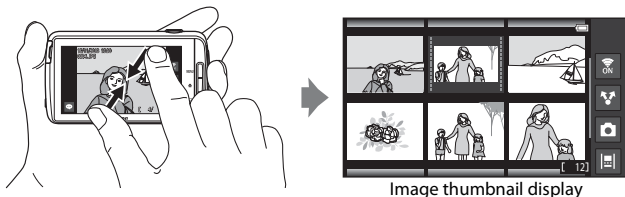

- You can also display thumbnails by moving the zoom control toward **W** (📐).
- The number of thumbnails displayed changes as your fingers move (spreading apart or pinching together). You can also change the number of thumbnails by moving the zoom control (**T** (📐)/**W** (📐)).
- Drag the monitor up or down to scroll through the images.
- While using image thumbnail playback mode, tap an image to display it in full-frame playback mode.

Timeline View (Chronological Display)

Display multiple images and comments (📖32) in a timeline that resembles a scroll. You can create a timeline for your favorite images or for images from various categories.

Adding Images to a Timeline

- 1 Tap  on the playback screen.

- The timeline list is displayed.



- 2 Tap the timeline to which to add the image.

- If images have already been added to the timeline, the images and comments are displayed in timeline view (📖68). Press the **MENU** button to add or remove the images (📖69).
- Touch and hold the timeline to change the name of the timeline. See “ Edit title” (📖69) for more information.



Timeline

- 3 Tap **Add/remove images**.

- The image selection screen is displayed.
- Tap **Edit title** to change the name of the timeline. See “ Edit title” (📖69) for more information.

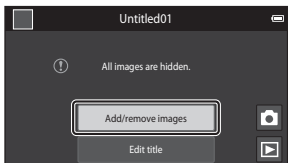

4 Tap the desired image to add .

- Multiple images can be selected. To deselect a selected image, tap the image again to remove .
- To change the number of images displayed, move the zoom control or use your fingers to pinch or spread the screen, in the same way as with thumbnail playback mode ([65](#)).



5 Tap .

- Images marked with  are added to the selected timeline and displayed in timeline view ([68](#)).

Notes About Timeline

- The maximum number of images that can be added to each timeline is 50.
- Movies cannot be added to a timeline.
- A timeline will be saved on the storage medium used (memory card or internal memory) when adding images to the timeline. If you change the storage medium, the added timeline cannot be displayed.
- The maximum number of timelines is fixed at 50. Timeline cannot be added or removed.
- A timeline cannot be duplicated, and cannot be copied to another storage medium (memory card or internal memory).

Displaying Images in Timeline View

On the screen shown in step 2 of “Adding Images to a Timeline” (📖66), tap a timeline that contains images.

- Title images are displayed for timelines that contain images.



Title image

When the images are displayed in timeline view, the operations listed below are available.

- Drag the screen up or down to scroll through the images.
- Tap an image to display it by itself. While images are displayed one at a time, you can zoom in on images (📖64) and scroll the playback of easy panorama images (📖40).

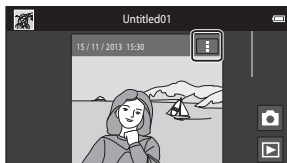

Timeline view

Drag the image to the right or left to display the previous or next image in the same timeline. Tap the image or press the ↶ button to return to timeline view.









- Tap **[E]** on each image to perform the operations listed below.
 - **Send to app:** Share the image (📖91).
 - **Choose as title image:** Set the image as the title image displayed in the timeline list.
 - **Edit comment:** Add or edit comments (📖32).
 - **Delete comment:** Delete the comments (available only for images with comments).

To hide the options, tap outside the options area or press the ↶ button.

- To cancel the timeline view display, tap the playback mode icon or shooting mode icon.

Functions That Can Be Set with the MENU Button (Timeline Menu)

When displaying images in timeline view, you can operate the menu options listed below by pressing the **MENU** button.

Option	Description
 Add/remove images	Add or remove images to or from the timeline. <ul style="list-style-type: none"> For more information on how to select images, see step 4 of “Adding Images to a Timeline” (66).
 Remove all	Remove all images.
 Edit title	Change the name of the timeline. <ul style="list-style-type: none"> See “Entering Text” (83) for more information. After you finish entering the name, tap  at the top left of the screen to save it. You cannot use the same name for multiple timelines.
 Sort	Change the image display order. <ul style="list-style-type: none"> Default setting: Newer images first
 Slide show	Play back images in the current timeline as an automated slide show ( 70).

Adding/Removing Images to/from Timeline

Images can be added to a timeline by selecting **Add to/remove from Timeline view** (70) in the playback menu. You can use this option to add or remove images to or from multiple timelines simultaneously.



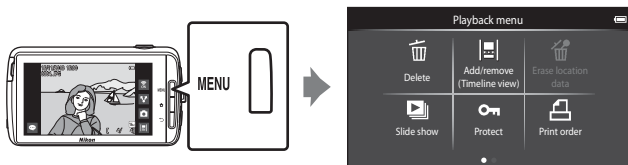

Functions That Can be Set with the MENU Button (Playback Menu)

When viewing images in full-frame playback mode or thumbnail playback mode, you can set the menu options listed below by pressing the **MENU** button (📖3).

- To display a previous/next option, flick the screen to the left or right.



Option	Description	📖
🗑️ Delete	Delete images and movies.	28
📅 Add to/remove from Timeline view ^{1,2}	Add the image displayed in full-frame playback mode to a timeline. The image can be simultaneously added to multiple timelines marked with ✓ on the timeline selection screen. Cancel the ✓ mark to remove the image from a timeline.	👓39
🗑️ Erase location data ¹	Delete the location data recorded for images or movies. Cannot be selected when no location information has been recorded (📖78).	👓39
📺 Slide show	View images in an automatic slide show.	👓40
🔒 Protect	Protect selected images from accidental deletion.	👓41
🖨️ Print order ²	Select which images are printed, and how many copies of each image are printed, prior to printing.	👓43
✍️ Retouch ^{1,2,3}	Edit images. Available editing functions are 🗑️ Quick retouch , 📷 D-Lighting , 🌀 Filter effects , 🧴 Skin softening , and 🖼️ Small picture .	👓6
	Use 🔄 Rotate image to rotate the displayed image to portrait or landscape orientation.	👓46

Option	Description	
 Volume ^{1,4}	Adjust the movie volume.	76
 Copy	Copy files between a memory card and the internal memory.	 47

¹ When using thumbnail playback mode, this function cannot be applied. Display the image in full-frame playback mode.

² The function cannot be used for movies.

³ Edited images are saved as separate files. Some images may not be edited.

⁴ The function can be used for movies only.

Recording and Playing Back Movies

Recording Movies

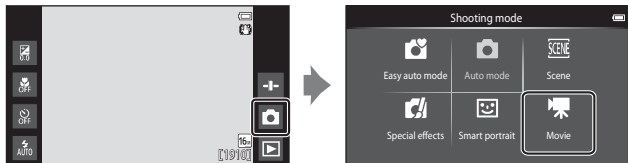

1 Press the shutter-release button all the way down to start recording.

- When the shutter-release button is pressed halfway, the camera focuses on a human face (when a face is detected) or on the subject at the center of the frame.
- You can take still images while recording a movie. See “Taking Still Images While Recording a Movie” (📖73).

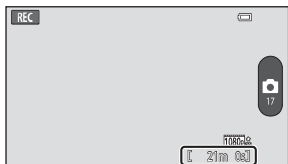

Maximum movie length

2 Press the shutter-release button again to end recording.

- Movie recording can also be started or stopped by tapping the monitor. See “Touch shooting” (📖75) for more information.

Taking Still Images While Recording a Movie

You can tap the button at the right of the screen during movie recording to capture a still image without stopping movie recording.

- The image is captured at the same size that is set in **Movie options** (📖75).
- Images cannot be captured while shooting an HS movie.
- The number of exposures remaining is displayed on the button (when there are 50 or less).

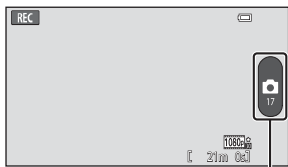

Record still image

Functions Available in Movie Recording

- Self-timer (📖49)
- Macro mode (📖51)
- Exposure compensation (📖52)
- Movie menu (📖75)

✓ Maximum Movie Length

Individual movie files cannot exceed 4 GB in size or 29 minutes in length, even when there is sufficient free space on the memory card for longer recording.

- The maximum movie length for a single movie is displayed on the shooting screen.
- Recording may end before either limit is reached if camera temperature becomes elevated.
- The actual movie length may vary depending on the movie content, subject movement, or type of memory card.

✓ Notes About Saving Images and Recording Movies

The indicator showing the number of exposures remaining or the indicator showing the maximum movie length flashes while images are being saved or while a movie is being recorded. **Do not open the battery-chamber cover or memory card slot cover or remove the battery or memory card** while an indicator is flashing. Doing this could result in loss of data, or in damage to the camera or the memory card.

✓ Recording Movies

- Memory cards with an SD Speed Class rating of 6 or faster are recommended when recording movies (🕒:20). Movie recording may stop unexpectedly when memory cards with a lower Speed Class ratings are used.
- Digital zoom degrades image quality.
- In some rare cases, movie recordings may capture the sounds of the camera itself, such as those made by the shutter-release button, the zoom control, the movement of the lens during zoom, autofocus, vibration reduction, or aperture control when the brightness changes.
- The following phenomena may be seen in the monitor while recording movies. These phenomena are saved in the recorded movies.
 - Banding may occur in images under fluorescent, mercury-vapor, or sodium-vapor lighting.
 - Subjects that move quickly from one side of the frame to the other, such as a moving train or car, may appear skewed.
 - The entire movie image may be skewed when the camera is panned.
 - Lighting or other bright areas may leave residual images when the camera is moved.
- When recording or playing back movies, colored stripes (interference patterns or moiré) may appear on subjects that have a regular, repeating grid, such as pattern of weave in clothing or windows in a building, depending on the shooting distance or zoom ratio. This phenomenon occurs when the subject's pattern interferes with the camera sensor grid, and it does not indicate a malfunction.

✓ Notes About Camera Temperature

- The camera temperature may increase significantly when used for an extended period of time for movie recording, etc., or when used in places with high ambient temperature.
- If the camera becomes extremely hot while recording a movie, the camera automatically terminates recording. The camera monitor displays the number of seconds remaining (🕒10s) until automatic termination is activated. After movie recording is terminated, the camera turns off. Wait until the internal temperature decreases before using it again.

✓ Notes About Autofocus for Movie Recording

When shooting a subject that is not suitable for autofocus (📖62), the camera may not be able to focus properly on the subject. Follow the procedure below if you are trying to shoot this type of subject for movies.

1. Set **Autofocus mode** in the movie menu to **AF-S Single AF** (default setting) before starting movie recording.
2. Frame a different subject (positioned at the same distance from the camera as the intended subject) in the center of the frame, press the shutter-release button halfway, modify the composition, and press the shutter-release button all the way down.

Functions That Can be Set with the MENU Button (Movie menu)

When recording movies, you can set the menu options listed below by pressing the **MENU** button (📖3).

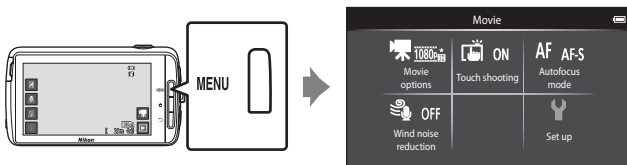

Option	Description	📖
🎥 Movie options	Select the movie type. Select either normal speed movies or HS (high speed) movies that play in slow or fast motion. • Default setting: 1080p 30p 1080★/30p	📖49
👆 Touch shooting	Select whether or not to start/stop movie recording when the monitor is tapped. • Default setting: ON On	📖50
AF Autofocus mode	Select between AF-S Single AF , which locks focus when movie recording starts, and AF-F Full-time AF , which continue focusing during movie recording. • Default setting: AF-S Single AF	📖51
🔊 Wind noise reduction	Select whether wind noise is reduced when recording movies. • Default setting: OFF off	📖51

Movie Playback

Tap the playback mode icon to enter playback mode.

- Movies can be recognized by the movie options (📖75) icon displayed on them.
- To adjust the volume before playback, press the **MENU** button and tap 🔊.
- Tap ▶ to play back movies.
- You can also listen to the movie sound by connecting commercially available headphones (📖2).



Movie option

Operations During Movie Playback

Tap the monitor during playback to display the control panel at the bottom of the screen. The operations listed below are available by tapping the icons in the panel.

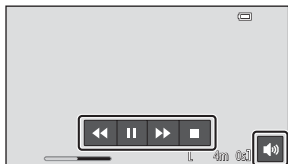

Operation	Icon	Description
Adjust volume	🔊	Adjust the volume. You can also move the zoom control to adjust the volume (📖1).
Rewind	⏮	Touch and hold ⏮ to rewind the movie.
Advance	⏭	Touch and hold ⏭ to advance the movie.
Pause	⏸	Pause playback. The following operation can be performed while playback is paused.
		▶ Resume playback.
End	■	End playback and return to full-frame playback mode.

Deleting movies

To delete a movie, select the desired movie in full-frame playback mode (📖26) or thumbnail playback mode (📖65), and press the **MENU** button and tap 🗑 (📖26).



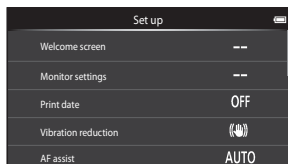

General Camera Setup

Functions That Can Be Set with the MENU Button (Setup Menu)

In the setup menu, the settings of the menu options listed below can be configured.



Option	Description	
Welcome screen	Allows you to select whether or not the welcome screen is displayed when the camera is turned on.	52
Monitor settings	Allows you to adjust Photo info , Image review , and Menu effects settings.	52
Print date	Allows you to imprint the shooting date and time on images at the time of shooting.	54
Vibration reduction	Allows you to select the vibration reduction setting used when shooting.	55
AF assist	Allows you to enable or disable the AF-assist illuminator.	56
Digital zoom	Allows you to enable and disable digital zoom.	56
Shutter sound	Select whether or not the shutter sound plays when the shutter is released.	57
HDMI	Allows you to adjust TV-connection settings.	57
Blink warning	Allows you to set whether or not closed eyes are detected when taking images of people using face detection.	58

Option	Description	
Record location data	<p>Allows you to set whether or not location data obtained by GPS or Wi-Fi* is recorded for images and movies.</p> <ul style="list-style-type: none"> When using this function, set Access to my location in Location access (86) to ON. 	 59
Reset all	Allows you to reset the camera's settings to their default values.	 60
Firmware version	View the current camera firmware version.	 60

* An Internet connection is required (88).

Using Android OS

Basic Operations for the Home Screen

Indicators on the Home Screen

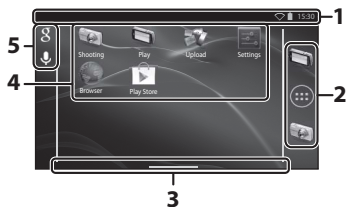

- Press the  button on any screen to display the home screen.
- The displayed information may vary depending on the Android OS settings or other conditions.



1	Status bar.....	81	4	Shortcuts (Applications).....	80
2	Dock bar.....	80	5	Google search bar.....	82
3	Screen indicator*.....	81			

* This indicator is displayed briefly when you switch screens.

Notes About Locking the Screen

- The screen locks when the following operations are performed:
 - When you turn the camera on and press the  button for the first time.
 - When you exit stand by mode and press the  button for the first time.
 - When you turn the camera on by pressing and holding the  button.
- To unlock the screen, drag the lock icon off the screen (default setting). After the screen is unlocked, the home screen is displayed.
- For privacy protection, we recommend that you change the unlock procedure in **Screen lock** in **Security** in the Android OS setting menu (📖87).
- Make a note of your unlock procedure so that you do not forget it. If you forget your unlock procedure, you will not be able to unlock the screen. If this happens, contact a Nikon-authorized service representative.

Activating the Main Applications

Tap the shortcuts on the home screen to activate the applications listed below. The location of shortcuts can be changed, and they can be added to or removed from the home screen (except the drawer).

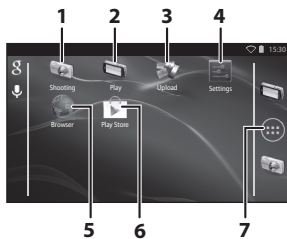

Application*	Description
1 Shooting	Activate the camera's shooting application (📖6).
2 Play	Activate the camera's playback application (📖8).
3 Upload	Activate the Upload to smart device application to transfer images and movies from the camera to your smart device (📖16).
4 Settings	Display the Android OS setting menu (📖86).
5 Browser	Open the browser and display web pages when connected to the Internet (📖92).
6 Play Store	Display Google Play™ Store (📖93).
7 Drawer	Display a list of icons of the installed applications (application screen) (📖93).

* The applications that are pre-installed in this camera may vary depending on the country or region.

Quitting Applications

When you press the button or button while using an application, the monitor switches to another screen such as the home screen, but the application may not quit. To reduce battery power consumption, it is recommended that you quit applications that you are not using.

Each application has a different way to quit. In some rare cases, you may quit applications using **Apps** in the setting menu (📖86).

Using Status Bar

The status bar is the area at the top of the Android OS screen in which notification icons are displayed.

You can check the icons indicating the status of newly received e-mail and active operations, and the status of the camera's functions such as the Wi-Fi (wireless LAN) connection status and battery level.



Notification Shade and Quick Settings

Drag the status bar down from the top of the screen to display the notification shade, or drag the status bar down with two fingers to display the quick settings menu.

- Tap the icon shown at the top right to switch between the notification shade and the quick settings menu.
- Press the  button or drag the notification shade or quick settings menu up to display the status bar again.

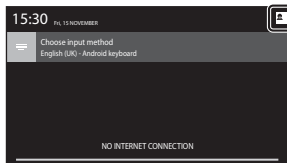

Notification shade

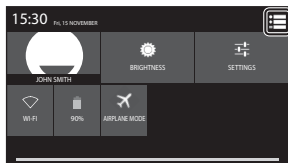

Quick settings

- In the notification shade, you can check the details of notifications displayed in the status bar.
- The quick settings allow you to adjust the monitor brightness and directly display the setting screens for functions such as Wi-Fi. Touch and hold **WI-FI** to turn the Wi-Fi (wireless LAN) function on or off.

Switching the Screen

The home screen and applications screen consist of multiple panes. To display a different pane on the home screen, flick the screen to the left or right.

You can check the screen indicator () to determine which pane of the screen is currently being displayed.



Using the Option Menu



On the home screen or applications screen, press the **MENU** button to select the options listed below.



Option	Description	
Wallpaper	You can select an image to use as home screen wallpaper.	–
Manage apps	You can check the information of installed applications, delete applications, etc.	86
System settings	Display the Android OS setting menu.	86

Using Google Search Bar

Tap  at the top left of the home screen to search for applications or other items saved in the camera. If the camera is connected to the Internet, you can search for information on the Internet (88).



- For more information about entering text, see “Entering Text” (83).
- After entering the desired text, tap  (Android keyboard) at the bottom right of the keyboard to start the search.

Entering Text

Enter text using the on-screen keyboard or the voice typing function.

Using the Keyboard

Tap the on-screen keyboard to enter text.

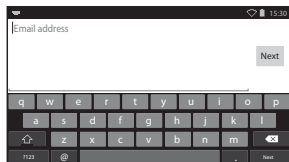
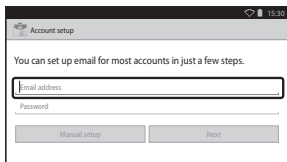

- The keyboard is displayed whenever you tap a text input area such as the search box. Press the  button to hide the on-screen keyboard.
- See “Other Keyboard Operations” ()84) for more information.



Example of English Keyboard







Changing the Type of Keyboard

While the keyboard is displayed, open the notification shade ()81) and tap **Choose input method** to change the type of keyboard (language or input software).

- The options that can be selected depend on the **Language & input** ()87) settings in the setting menu.
- You can download additional types of input software from the Google Play Store ()93).

Other Keyboard Operations





Tap the keys listed below to perform operations such as changing character types, deleting text, and inserting a space.

Key	Description
	Switches the keyboard between alphabet and numbers/symbols.
	Inserts a line break.
	Inserts a space.
	Switches between upper case, lower case, and symbols.
	Deletes characters to the left of the cursor.
	Displays additional symbols on the keyboard.

* Displayed key varies depending on the current operating condition.

Editing Text

You can edit text using the operations listed below.

Operation	Description
Move the cursor	Tap the location where you want to insert the cursor. Drag  to move the cursor.
Select the text	Touch and hold the desired text to select it. You can also drag the text to select it. Drag  or  to change the selection area. To select all of the entered text, touch and hold the text, and tap SELECT ALL *.
Cut/copy	Select the text and tap CUT * or COPY *.
Paste	Move the cursor to the location where you want to paste the text, tap  , and then tap PASTE *. If you paste while text is selected, the selected text is replaced by the pasted text.

* This option is displayed above the text input area.

Using the Voice Typing Function

The camera can recognize speech and enter it as text.

- To use voice typing without connecting to the Internet, you must install an offline speech recognition data on the camera. If you connect the camera to the Internet, you can use the voice typing function without installing a data.

1 Install an offline speech recognition data.

- A separate data must be installed for each language. Japanese and English data are pre-installed in the camera.
- To install the data, connect the camera to the Internet and add a check mark to **Google voice typing** in **Language & input** (📖87) in the setting menu, and tap .
Select **Download offline speech recognition** and **ALL** to download the data for each language.

2 Tap a text input area to display the keyboard.

3 Open the notification shade and tap **Choose input method**.

- For more information about using the notification shade, see “Using Status Bar” (📖81).
- If **Choose input method** is not displayed, add a check mark to **Google voice typing** in **Language & input** (📖87) in the setting menu.







4 Tap **Google voice typing** and speak into the built-in microphone to enter the desired text.



- This function cannot be used with a third-party external microphone.



Using Android OS Setting Menu

On the home screen, tap  **Settings** to set the options listed below.



Option	Description	
Wi-Fi	Configure the Wi-Fi (wireless LAN) settings.	88,  61
Data usage	Check the amount of data uploaded or downloaded by the camera during a certain period, and control the amount of usage.	-
Airplane mode	Disable all wireless communication settings.	-
Sound	Configure sound settings such as Touch sounds .	 62
Display	Configure screen display settings such as Brightness, Auto-rotate screen, Display off, and Shut-down timer .	 62,  63
Storage	Select Erase SD card to format the memory card. Check the amount of space available in the internal memory, on the memory card, etc.	 63
Battery	Check the battery power consumption for each application.	-
Apps	Configure the application settings, and manage applications that are already installed on the camera.	80, 93
Location access	Enable the camera and applications to use the location data obtained using the GPS or Wi-Fi.	 64

Option	Description	
Security	Configure security settings such as Screen lock .	79
Language & input *	Configure the display language, text input settings, and text-to-speech settings.	 67
Backup & reset	Configure Reboot and Factory data reset (format the internal memory).	 67
Add account	Add online service accounts.	90
Date & time	Configure the date and time settings, set the date/time display format, and select the time zone.	17
Accessibility	Configure the settings for user accessibility services.	-
About device	Check the battery level or Android OS version.	-

* If you accidentally select the wrong language, press the  button, go to  **Settings** followed by  **Language & input**, and then reselect the **Language** option, which is the top item in the list.

Using the Internet

An Internet connection is required in order to use online service. Configure the Wi-Fi (wireless LAN) network before using the Internet.

Setting Up a Wi-Fi (Wireless LAN) Network

Press the  button →  Settings → Wi-Fi

You must have access to a Wi-Fi (wireless LAN) network. Before configuring the Wi-Fi (wireless LAN) settings on the camera, make sure that your Wi-Fi (wireless LAN) network is set up and that you know your network SSID and password.

1 Tap the ON/OFF button to turn it **ON**.

- The Wi-Fi (wireless LAN) function turns on, and a list of available SSIDs (names of Wi-Fi (wireless LAN) networks) is displayed on the screen.
- It may take a few seconds for the Wi-Fi (wireless LAN) function to turn on.



2 Tap the desired SSID, enter the password, and tap **Connect**.

- When the connection is established, **Connected** is displayed under the network SSID.
- The camera will remember the security information, allowing you to connect without entering the details again.
- You can connect to an open network without entering a password, but it may not be secure. Before connecting, check the icon displayed to the right of the SSID to determine whether the network is open or secure.
- To end the network connection, tap the selected SSID and tap **Forget**.



Notes About Wi-Fi (Wireless LAN) Networks

- For more information on configuring a private Wi-Fi (wireless LAN) network, contact your Wi-Fi service provider.
- The camera may not be able to connect to some Wi-Fi (wireless LAN) networks. For details about a particular network, contact the Wi-Fi service provider or a dealer.
- Wi-Fi (wireless LAN) networks use a wireless signal to transmit information, making them convenient to use with devices within range of the signal. However, without the proper security settings, unauthorized third parties may be able to access the network and cause harm. Security settings are recommended, though it is solely the responsibility of the user to determine whether or not to use them.

Notes About Using Internet

You can use the Internet to access a variety of information, but there is a risk of infecting the camera with a virus.

To help prevent virus infection, we recommend that you periodically scan for viruses (using tools such as online virus scanners) and install anti-virus software.

Setting Up a Google Account

Press the  button →  Settings → Add account

Setting a Google account allows you to install various applications from the Google Play Store and take advantage of other Google services on your camera.

Google accounts are free of charge, and the user name can be used as a email address. You can register multiple accounts to this camera.

- An Internet connection is required.
Set up your Wi-Fi (wireless LAN) network (88).

1 Tap **Google**.

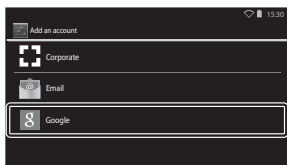

2 Tap **New**.

- Follow the on-screen instructions to configure the settings.
- When the settings are complete, **Google** is displayed above **Add account**.

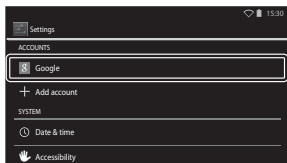
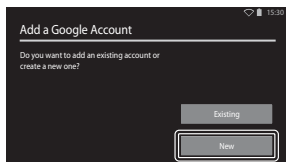

Sharing Images

You can share images and movies with other applications.

For example, you can upload your images and movies to the Internet if you share them with an application that provides online services.

- Some sharing applications require an Internet connection. Set up your Wi-Fi (wireless LAN) network (📖88).

1 Display the image you want to share in full-frame playback mode, and tap .

- The sharing function can be used in timeline view (📖68).
- If the image has no comments, proceed to step 3.



2 Select whether or not to share comments.

- **Image only:** Share the image only.
- **Image and comment:** Share the image with comments.







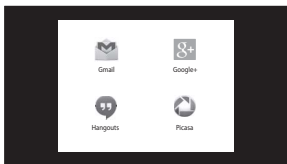



3 Select the application for the online service.

- If the application that you want to use is not displayed, download it from the Google Play Store (📖93).
- For more information on how to use a particular application, refer to the support for that application.



Sharing Multiple Images Simultaneously

Tap  in thumbnail playback mode (65) to display the image selection screen, and select multiple images to share.

- Tap images to add . To deselect a selected image, tap the image again to remove .
- To change the number of images displayed, move the zoom control or use your fingers to pinch or spread the screen, in the same way as with thumbnail playback mode (65).
- Tap  to display the screen shown in step 3 of “Sharing Images” (91). For more information on how to use a particular application, refer to the support for that application.
- If you want to share comments, follow the procedure for sharing images in full-frame playback mode (91).





Notes About Images with Comments

Some applications may not allow you to share comments, even if **Image and comment** is selected.

Using the Internet

You can use the Internet browser to view content online, just as you would on a personal computer.

- Tap  (Browser) on the home screen (80).
- Tap the address (URL) bar at the top of the browser window, and enter a URL or search keyword.

Using Google Play Store (Getting Applications)

This service may not be available depending on the country or region.

1 Tap (Play Store) on the home screen.

- When you access Google Play Store for the first time, the terms of service are displayed.

2 Select the application, and follow the on-screen instructions to download it.

- You can search for the applications by category or keyword.
- Before selecting an application, check the description, reviews, and other information about it.

Notes About Installing Applications

- You are responsible for confirming the safety of applications before installing them. Some applications may contain viruses or other unwanted software that can damage or destroy the data on your device.
- Please note that in the event you install an application that causes problems with the camera, Nikon assumes no responsibility for any loss or damage to you or any third party arising from the application you installed.
- There is no guarantee that this camera will work with all applications. For details about a particular application, contact the developer of that application.
- Some of the camera's functions may not be fully available when using a downloaded shooting application.

Notes About Pre-installed Applications

A variety of applications are pre-installed in this camera at the time of purchase.

For more information on the various Google applications installed in the camera, visit the following URL:

<http://www.google.com/support/mobile/?hl=en>

Please note that this site is managed by Google Inc., and is subject to change without notice.

Using a Headset

This camera is compatible with commercially available headsets. Connect a headset to the camera's headset connector to use it (.

Connecting the Camera to a TV and Computer

Connection Methods

You can enhance your enjoyment of images and movies by connecting the camera to a TV and computer.

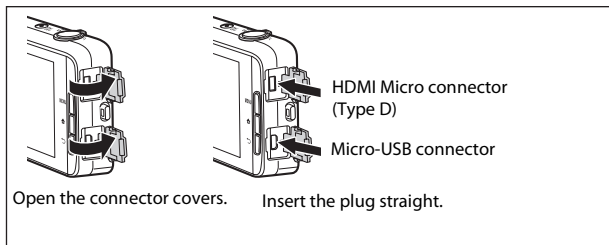

- Before connecting the camera to an external device, make sure the remaining battery level is sufficient.
- If the AC Adapter EH-67A (available separately) is used, this camera can be powered from an electrical outlet. Do not use any other make or model of AC adapter as it may cause the camera to heat up or malfunction.
- For information about the connection methods and subsequent operations, refer to the documentation included with the device in addition to this document.



You can view the camera's images and movies on a TV.

Connection method: Connect a commercially available HDMI cable to the TV's HDMI input jack.

- Before connecting the camera to a TV, make sure to turn the camera off. Before disconnecting, make sure to turn the camera off.





You can transfer images to a computer to perform simple retouching and manage image data.

Connection method: Connect the camera to the computer's USB input jack with the included USB cable, and tap **Turn on USB storage** on the camera screen. For more information about disconnecting, see steps 1 and 3 of "Transferring Images to the Computer" ( 97).

- Before connecting to a computer, install ViewNX 2 on the computer ( 96).
- If any USB devices that draw the power from the computer are connected, disconnect them from the computer before you connect the camera to it. Connecting the camera and other USB-powered devices to the same computer simultaneously may cause a camera malfunction or excessive power supply from the computer, which could damage the camera or memory card.
- When connecting the camera to a computer, turn on the camera.

Notes About Connecting the Camera to a Computer

When the camera is connected to a computer, you cannot turn off the camera while the USB storage option on the camera screen is turned on. In addition, the availability of some functions is limited, as described below.

- Shooting and playback functions are not available.
- The camera does not enter stand by mode ( 31). The display off mode is available when you press the power switch.
- You cannot use the menu accessed by pressing and holding the power switch ( 3).
- The **Reboot** option cannot be selected in **Backup & reset** ( 87) in the Android OS setting menu.

To turn off the USB storage, press the  button to display the home screen, open the notification shade, and tap **Turn off USB storage** ( 81).

Using ViewNX 2

ViewNX 2 is an all-in-one software package which enables you to transfer, view, edit and share images.

Your Imaging Toolbox

ViewNX 2™



Installing ViewNX 2

- An Internet connection is required.
- Refer to the Nikon website for details on system requirements, including the latest information on operating system compatibility.

1 Start the computer and download the ViewNX 2 installer from the URL below.

<http://nikonimglib.com/nvnx/>

2 Double-click the installer file.

3 Follow the on-screen instructions to install the software.

The following software is installed:

- ViewNX 2 (consisting of the 3 modules below)
 - Nikon Transfer 2: For transferring images to the computer
 - ViewNX 2: For viewing, editing, and printing transferred images
 - Nikon Movie Editor: For basic editing of transferred movies

4 Exit the install.

- Windows: Click **Yes**.
- Mac OS: Click **OK**.

Transferring Images to the Computer

1 Choose how images will be copied to the computer.

Choose one of the following methods:

- **Direct USB connection:** Turn the camera on with the memory card inserted, connect it to the computer using the included USB cable, and tap **Turn on USB storage** on the camera screen.

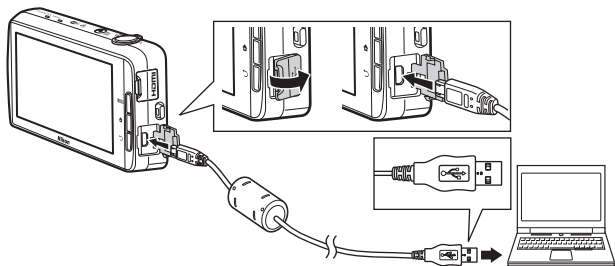

- **Memory card slot:** If your computer is equipped with a memory card slot, the card can be inserted directly in the slot.
- **Memory card reader:** Connect a card reader (available separately from third-party suppliers) to the computer and insert the memory card.

If a message is displayed prompting you to choose a program, select Nikon Transfer 2.

If the memory card contains a large number of images, it may take a while for Nikon Transfer 2 to start. Wait until Nikon Transfer 2 starts.

✓ Connecting the USB Cable

The connection may not be recognized if the camera is connected to the computer via a USB hub.

2 Transfer images to the computer.

- Confirm that the recording medium (memory card or internal memory) of the connected camera or removable disk is displayed as the “Source” on the “Options” title bar of Nikon Transfer 2 (①).
 - When the camera and computer are connected, select the recording medium (memory card or internal memory) that contains the images you want to transfer.
- Click **Start Transfer** (②).
 - To transfer images saved on both recording media (memory card and internal memory), uncheck **Disconnect automatically after transfer** in **Preferences** and then click **Start Transfer**.

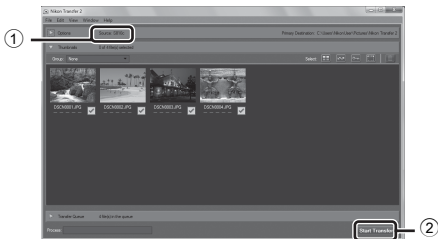

- At default settings, all the images on the memory card will be copied to the computer. Comments that have been added to images are also transferred with the images (32).
 - When the transfer of images from one recording medium is completed while **Disconnect automatically after transfer** is unchecked, Nikon Transfer 2 quits automatically and ViewNX 2 starts. If you want to continue transferring images from another recording medium, click **Transfer** on the ViewNX 2 toolbar, start Nikon Transfer 2, and then import the images to the computer.

3 Terminate the connection.

- If the camera is connected to the computer, follow the procedure below to disconnect it.
 - On the computer, eject the removable disk.
 - Tap **Turn off USB storage** on the camera screen. If **Turn off USB storage** is not displayed, you can select it in the notification shade on the home screen (81).
 - Disconnect the USB cable.
- If you are using a card reader or card slot, choose the appropriate option in the computer operating system to eject the removable disk corresponding to the memory card and then remove the card from the card reader or card slot.

Viewing Images

Start ViewNX 2.

- Images are displayed in ViewNX 2 when transfer is complete.
- Consult online help for more information on using ViewNX 2.

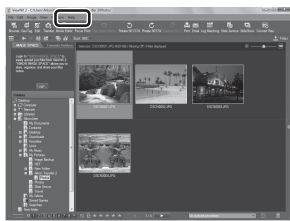

Starting ViewNX 2 Manually

- **Windows:** Double-click the **ViewNX 2** shortcut on the desktop.
- **Mac OS:** Click the **ViewNX 2** icon in the Dock.



A series of horizontal dashed lines spanning the width of the page, intended for handwriting practice.



Technical Notes and Index

Caring for the Product	2
The Camera	2
The Battery	3
Charging AC Adapter	4
Memory Cards	5
Cleaning and Storage	6
Cleaning	6
Storage	6
Troubleshooting	7
Specifications	15
Approved Memory Cards	20
Index	23

Caring for the Product

The Camera

To ensure continued enjoyment of this Nikon product, observe the precautions described below in addition to the warnings in "For Your Safety" (📖vii–ix) when using or storing the device.

✔ **Keep Dry**

The device will be damaged if immersed in water or subjected to high humidity.

✔ **Do Not Drop**

The product may malfunction if subjected to strong shock or vibration.

✔ **Handle the Lens and All Moving Parts with Care**

Do not apply force to the lens, lens cover, monitor, memory card slot or battery-chamber. These parts are easily damaged. Applying force to the lens cover could result in camera malfunction or damage to the lens. Should the monitor break, care should be taken to avoid injury caused by broken glass and to prevent the liquid crystal from the display touching the skin or entering the eyes or mouth.

✔ **Do Not Point the Lens at Strong Light Sources for Extended Periods**

Avoid pointing the lens at the sun or other strong light sources for extended periods when using or storing the camera. Intense light may cause deterioration of the image sensor, producing a white blur effect in photographs.

✔ **Keep Away from Strong Magnetic Fields**

Do not use or store this device in the vicinity of equipment that generates strong electromagnetic radiation or magnetic fields. Strong static charge or the magnetic fields produced by equipment such as radio transmitters could interfere with the monitor, damage data saved on the memory card, or affect the product's internal circuitry.

✔ **Avoid Sudden Changes in Temperature**

Sudden changes in temperature, such as when entering or leaving a heated building on a cold day, can cause condensation to form inside the device. To prevent condensation, place the device in a carrying case or a plastic bag before exposing it to sudden changes in temperature.

Turn the Product Off Before Removing or Disconnecting the Power Source or Memory Card

Do not remove the battery while the product is on, or while images are being saved or deleted. Forcibly cutting power in these circumstances could result in loss of data or in damage to product memory or internal circuitry.

Notes About the Monitor

- Monitors and electronic viewfinders are constructed with extremely high precision; at least 99.99% of pixels are effective, with no more than 0.01% being missing or defective. Hence while these displays may contain pixels that are always lit (white, red, blue, or green) or always off (black), this is not a malfunction and has no effect on images recorded with the device.
- Images in the monitor may be difficult to see under bright lighting.
- The monitor is lit by an LED backlight. Should the monitor begin to dim or flicker, contact your Nikon-authorized service representative.

The Battery

Be sure to read and follow the warnings in “For Your Safety” ( vii–ix) before use.

- Check the battery level before using the camera, and replace or charge the battery if necessary. Do not continue charging once the battery is fully charged as this will result in reduced battery performance. Whenever possible, carry a fully charged spare battery when taking images on important occasions.
- Do not use the battery at ambient temperatures below 0°C (32°F) or above 40°C (104°F).
- Charge the battery indoors with an ambient temperature of 5°C to 35°C (41°F to 95°F) before use.
- When charging the battery inserted into this camera using the Charging AC Adapter or a computer, the charge capacity may decrease at ambient temperatures 45°C to 60°C (113°F to 140°F).
- The battery is not charged at battery temperatures below 0°C (32°F) or above 60°C (140°F).
- Note that the battery may become hot during use; wait for the battery to cool before charging. Failure to observe these precautions could damage the battery, impair its performance, or prevent it from charging normally.
- On cold days, the capacity of batteries tends to decrease. If an exhausted battery is used at a low temperature, the camera may not turn on. Be sure that the battery is fully charged before heading outside to take images in cold weather. Keep spare batteries in a warm place and exchange as necessary. Once warmed, a cold battery may recover some of its charge.
- Dirt on the battery terminals can prevent the camera from functioning. Should the battery terminals become dirty, wipe them off with a clean, dry cloth before use.

- If the battery will not be used for some time, insert it in the camera and completely exhaust it before removing it for storage. The battery should be stored in a cool location with an ambient temperature of 15°C to 25°C (59°F to 77°F). Do not store the battery in hot or extremely cold locations.
- Always remove the battery from the camera or optional battery charger when it is not being used. When inserted, minute amounts of current are drawn from the battery even when not in use. This may result in excessive draining of the battery and complete loss of function. Turning the camera on or off while the battery is exhausted can result in reduced battery life.
- Recharge the battery at least once every 6 months and completely exhaust it before returning it to storage.
- After removing the battery from the camera or optional battery charger, replace the included terminal cover and store it in a cool place.
- A marked drop in the time a fully-charged battery retains its charge, when used at room temperature, indicates that the battery needs to be replaced. Purchase a new EN-EL23 battery.
- Replace the battery when it no longer holds a charge. Used batteries are a valuable resource. Please recycle used batteries in accordance with local regulations.

Charging AC Adapter

Be sure to read and follow the warnings in “For Your Safety” (📖vii–ix) before use.

- The Charging AC Adapter EH-71P is for use only with compatible devices. Do not use with another make or model of device.
- Do not use a USB cable other than the UC-E21. Using a USB cable other than the UC-E21 could result in overheating, fire or electric shock.
- The EH-71P is compatible with AC 100 V–240 V, 50/60 Hz electrical outlets. When using in other countries, use a plug adapter (available commercially) as necessary. For more information about plug adapters, consult your travel agency.
- Do not, under any circumstances, use another make or model of AC adapter other than Charging AC Adapter EH-71P, and do not use a commercially available USB-AC adapter or a battery charger for a mobile phone. Failure to observe this precaution could result in overheating or in damage to the camera.

Memory Cards

- Use only a microSDHC/microSDXC memory cards. See “Approved Memory Cards” (P.20) for more information about memory cards.
- Be sure to follow the precautions described in the documentation included with the memory card.
- Do not put labels or stickers on memory cards.
- The first time you insert a memory card that has been used in another device into this camera, be sure to format it with this camera. We recommend formatting new memory cards with this camera before using them with this camera.
- Note that **formatting permanently deletes all images and other data on the memory card**. Be sure to make copies of any images you wish to keep before formatting the memory card.
- Do not perform the following during formatting, while data is being written to or deleted from the memory card, or during data transfer to a computer. Failure to observe this precaution could result in the loss of data or in damage to the camera or memory card:
 - Open the battery-chamber cover to remove/insert the battery.
 - Open the memory card slot cover to remove/insert the memory card.
 - Turn off the camera.
 - Disconnect the AC adapter.
- Do not format the memory card using a computer.

Cleaning and Storage

Cleaning

Do not use alcohol, thinner, or other volatile chemicals.

Lens	Avoid touching glass parts with your fingers. Remove dust or lint with a blower (typically a small device with a rubber bulb attached to one end that is pumped to produce a stream of air out the other end). To remove fingerprints or other stains that cannot be removed with a blower, wipe the lens with a soft cloth, using a spiral motion that starts at the center of the lens and working toward the edges. If this fails, clean the lens using a cloth lightly dampened with commercial lens cleaner.
Monitor	Remove dust or lint with a blower. To remove fingerprints and other stains, clean the monitor with a soft, dry cloth, being careful not to apply pressure. Wiping with too much force or with a hard cloth may damage the monitor or cause it to malfunction.
Body	Use a blower to remove dust, dirt or sand, then wipe gently with a soft, dry cloth. After using the camera at the beach or other sandy or dusty environment, wipe off any sand, dust, or salt with a dry cloth lightly dampened with fresh water and dry thoroughly. Note that foreign matter inside the camera could cause damage not covered by the warranty.

Storage

Turn the camera off when not in use. Be sure that the power-on lamp is off before putting the camera away. Remove the battery if the camera will not be used for an extended period. Do not store the camera with naphtha or camphor moth balls, or in any of the following locations:

- Next to equipment that produces strong electromagnetic fields, such as televisions or radios
- Exposed to temperatures below -10°C (14°F) or above 50°C (122°F)
- Places that are poorly ventilated or subject to humidity of over 60%





To prevent mold or mildew, take the camera out of storage at least once a month. Turn the camera on and release the shutter a few times before putting the camera away again.



For storing the battery, follow the precautions in "The Battery" (🔋:3) in "Caring for the Product".

Troubleshooting







If the camera fails to function as expected, check the list of common problems below before consulting your retailer or Nikon-authorized service representative.









Power Supply, Display, and Settings











Problem	Cause/Solution	
The camera is on but does not respond.	Wait for recording to end. If the problem persists, turn the camera off. If the camera does not turn off, remove and reinsert the battery or batteries or, if you are using an AC adapter, disconnect and reconnect the AC adapter. Note that although any data currently being recorded will be lost, data that have already been recorded will not be affected by removing or disconnecting the power source.	30,  72
Battery inserted in the camera cannot be charged.	Confirm all connections.	12
Camera cannot be turned on.	<ul style="list-style-type: none">• The battery is exhausted.	12, 18
Camera turns off without warning.	<ul style="list-style-type: none">• The camera is turned off by the shut-down timer.	31
	<ul style="list-style-type: none">• The internal temperature of the camera is high. Allow the camera and memory card to cool and turn on the camera again.	18,  68
	<ul style="list-style-type: none">• The camera and battery may not operate properly at low temperatures.• No battery power remains.	 3 12, 18
Monitor is blank.	<ul style="list-style-type: none">• The camera is off.• The camera has entered display off mode or stand by mode to save power. Press the power switch.	18 31,  62
Camera becomes hot.	The camera may become hot when shooting movies for an extended period of time or when the camera is used in a hot area; this is not a malfunction.	–



Problem	Cause/Solution	
Wi-Fi (wireless LAN) function turns off and will not turn on.	<ul style="list-style-type: none"> In some rare cases, the Wi-Fi (wireless LAN) function turns off suddenly and will not turn on. Reboot the camera then turn on the Wi-Fi (wireless LAN) settings. 	3, 87,  67
Camera makes sound.	When Autofocus mode is set to Full-time AF or while in some shooting modes, the camera may produce an audible focusing sound.	75

Shooting

Problem	Cause/Solution	
No image taken.	<ul style="list-style-type: none"> When the camera is in playback mode, or setting items or setup menu are displayed, press the shutter-release button. 	26
	<ul style="list-style-type: none"> The battery is exhausted. When the flash indicator flashes, the flash is charging. 	18 47
Cannot switch to shooting mode.	<ul style="list-style-type: none"> Disconnect the HDMI cable or USB cable. 	94,  14
	<ul style="list-style-type: none"> Turn off USB storage. 	95
Camera cannot focus.	<ul style="list-style-type: none"> The subject is too close. Try shooting using macro mode, easy auto mode, or Close-up scene mode. 	34, 39, 51
	<ul style="list-style-type: none"> The intended subject is not suitable for autofocus. 	62
	<ul style="list-style-type: none"> Set AF assist in the setup menu to Auto. Turn the camera off and then on again. 	77,  56 18, 30
Images are blurred.	<ul style="list-style-type: none"> Use the flash. Increase the ISO sensitivity value. 	47 56,  29
	<ul style="list-style-type: none"> Enable vibration reduction. Use BSS (Best Shot Selector). Use a tripod to stabilize the camera when shooting (using the self-timer at the same time is more effective). 	77,  55  30 49







Problem	Cause/Solution	
Bright specks appear in images taken with flash.	The flash is reflecting off particles in the air. Set the flash mode setting to  (Off).	47
Flash does not fire.	<ul style="list-style-type: none"> • The flash mode setting is set to  (Off). • A scene mode that restricts the flash is selected. • The movie is selected for shooting mode. • A function that restricts the flash is enabled. 	48 53 72 57
Digital zoom cannot be used.	<ul style="list-style-type: none"> • Digital zoom is set to Off in the setup menu. • Digital zoom is not available in the following situations: <ul style="list-style-type: none"> - When Portrait, Night portrait, Backlighting (when HDR is set to On), Easy panorama, or Pet portrait scene mode is selected - When shooting in smart portrait mode - When touch shooting is set to Subject tracking - When Multi-shot 16 is selected for the Continuous setting 	77,  56 37 44 56,  26 56,  30
Image mode not available.	A function that restricts the Image mode option is enabled.	57
No sound when the shutter is released.	<ul style="list-style-type: none"> • Off is selected for Shutter sound in the setup menu. No sound is heard with some shooting modes and settings, even when On is selected. • The speaker is blocked. Do not cover the speaker. 	77,  57 2, 22
AF-assist illuminator does not light.	Off is selected for the AF assist option in the setup menu. AF-assist illuminator may not light depending on the position of the focus area or the current scene mode, even when Auto is selected.	77,  56



Problem	Cause/Solution	
Images appear smeared.	The lens is dirty. Clean the lens.	 6
Colors are unnatural.	White balance does not match light source.	56,  32
Randomly spaced bright pixels (“noise”) appear in image.	The shutter speed is too slow or ISO sensitivity is high as the subject is dark. Noise can be reduced by: <ul style="list-style-type: none"> • Using the flash • Specifying a lower ISO sensitivity setting 	47 56,  29
Images are too dark (underexposed).	<ul style="list-style-type: none"> • The flash mode setting is set to  (Off). • The flash window is blocked. • The subject is beyond the range of the flash. • Adjust exposure compensation. • Increase the ISO sensitivity. • The subject is backlit. Select Backlighting scene mode or set the flash mode setting to  (Fill flash). 	47 22 51 52 56,  29 40, 47
Images are too bright (overexposed).	Adjust exposure compensation.	52
Unexpected results when flash set to  (auto with red-eye reduction).	When taking images with  (auto with red-eye reduction) or fill flash with slow sync and red-eye reduction in Night portrait scene mode, the In-Camera Red-Eye Fix processing may be applied to areas not affected by red-eye. Use any scene mode other than Night portrait , and change the flash mode to any setting other than  (auto with red-eye reduction) and try taking an image again.	39, 48
Skin tones are not softened.	<ul style="list-style-type: none"> • Under some shooting conditions, facial skin tones may not be softened. • Select Skin softening in the retouch menu for images containing four or more faces. 	62 70,  11

Problem	Cause/Solution	
Saving images takes time.	It may take more time to save images in the following situations: <ul style="list-style-type: none"> • When the noise reduction function is in operation • When flash mode is set to  (auto with red-eye reduction) • When shooting in Backlighting scene mode (when HDR is set to On) • When the skin softening function is applied while shooting 	– 48 40 56,  36
A ring-shaped belt or rainbow-colored stripe appears in the monitor or images.	When shooting with backlighting or when a very strong light source (such as sunlight) is in the frame, a ring-shaped belt or rainbow-colored stripe (ghosting) may occur. Change the position of the light source, or frame the picture so that the light source does not enter the frame, and try again.	–
Cannot use some shooting functions.	<ul style="list-style-type: none"> • Until the Android OS starts up completely, you can take only a limited number of images and cannot change the shooting settings. Wait a while before configuring the settings or shooting. • Some of the camera's functions may not be fully available when using a downloaded shooting application. 	19 93

Playback

Problem	Cause/Solution	
File cannot be played back.	<ul style="list-style-type: none"> • This camera may not be able to play back images saved with another make or model of digital camera. • This camera cannot play back movies saved with another make or model of digital camera. • This camera may not be able to play back data edited on a computer. 	–

Problem	Cause/Solution	
Cannot zoom in on image.	<ul style="list-style-type: none"> The images taken with cameras other than this camera may not be enlarged. Playback zoom cannot be used with movies, small pictures. 	– –
Cannot edit images.	<ul style="list-style-type: none"> Some images cannot be edited. Images that have already been edited may not be edited again. There is not enough free space in the internal memory or on the memory card. This camera is unable to edit images saved with other cameras. Editing functions used for images are not available for movies. 	70,  – 70,  –
Cannot add/edit comments.	<ul style="list-style-type: none"> The image is protected. Unprotect the image. There is not enough free space in the internal memory or on the memory card. 	28, 33, 70
Cannot delete comments.	If you delete all comments using  (Edit), you cannot finish editing. Use  (Delete) to delete comments.	33
Cannot edit timeline.	There is not enough free space in the internal memory or on the memory card.	28, 66
Images not displayed on television.	<ul style="list-style-type: none"> Select the correct HDMI option. Both HDMI cable and the USB cable are connected to the camera. The memory card contains no images. Replace the memory card. Remove the memory card to play back images saved in the internal memory. 	77,  94, 97,  14 14
Nikon Transfer 2 does not start when camera is connected to a computer.	<ul style="list-style-type: none"> The camera is off. The battery is exhausted. The USB cable is not correctly connected. Confirm the compatible operating systems. The camera is not recognized by the computer. Refer to help information contained in ViewNX 2. 	18 12, 18 97 96 97 99

Problem	Cause/Solution	
The image cannot be printed with the correct aspect ratio (horizontal to vertical).	<ul style="list-style-type: none"> When printing images taken at an Image mode setting of $\frac{16:9}{12:9}$ 4608×2592, $\frac{16:9}{2:3}$ 1920×1080 or $\frac{16:9}{12:9}$ 3456×3456 the edges of images may be cropped, preventing the complete image or correct aspect ratio from being printed. Change the printer setting to "Border". Refer to the documentation included with the printer for further details. Take images at an Image mode setting other than $\frac{16:9}{12:9}$ 4608×2592, $\frac{16:9}{2:3}$ 1920×1080 or $\frac{16:9}{12:9}$ 3456×3456. 	<p>–</p> <p>–</p> <p>56, 22</p>
Cannot print panoramas.	When printing panoramas, the entire image may not be able to be printed depending on the printer's settings. Additionally, printing may not be possible depending on the printer. See the documentation included with the printer or consult a digital photo lab for details.	–

Others

Problem	Cause/Solution	
Cannot unlock the screen.	<ul style="list-style-type: none"> You are not using the correct unlock procedure. Make sure to use the correct procedure. If you forget your unlock procedure, you will not be able to unlock the screen. If this happens, contact a Nikon-authorized service representative. 	79

Specifications

Nikon COOLPIX S810c Digital Camera

Type	Compact digital camera
Number of effective pixels	16.0 million
Image sensor	$\frac{1}{2.3}$ -in. type CMOS; total pixels: approx. 16.79 million
Lens	NIKKOR lens with 12x optical zoom
Focal length	4.5–54.0 mm (angle of view equivalent to that of 25–300 mm lens in 35mm [135] format)
f/-number	f/3.3–6.3
Construction	9 elements in 7 groups (1 ED lens element)
Digital zoom magnification	Up to 4x (angle of view equivalent to that of approx. 1200 mm lens in 35mm [135] format)
Vibration reduction	Combination of lens shift and electronic VR (still images) Lens shift (movies)
Motion blur reduction	Motion detection (still pictures)
Autofocus (AF)	Contrast-detect AF
Focus range	<ul style="list-style-type: none">• [W]: Approx. 50 cm (1 ft 8 in.)–∞• [T]: Approx. 1.5 m (5 ft)–∞• Macro mode: Approx. 2 cm (0.8 in.)–∞ (wide-angle position) (All distances measured from center of front surface of lens)
Focus-area selection	Face priority, auto (9-area automatic selection), center, manual (focus area can be selected using the touch panel), subject tracking, target finding AF
Monitor	9.4 cm (3.7-in.), widescreen, TFT LCD monitor (touch panel) with anti-reflection coating, approx. 1229k-dot, 9-level brightness adjustment
Frame coverage (shooting mode)	Approx. 98% horizontal and 98% vertical (compared to actual image)
Frame coverage (playback mode)	Approx. 100% horizontal and 100% vertical (compared to actual image)

Storage	
Media	<ul style="list-style-type: none"> Internal memory Spaces available for saving images: approx. 1.1 GB Spaces available for saving applications: approx. 1 GB (varying depending on the country or region) microSDHC/microSDXC memory card
File system	DCF, Exif 2.3, DPOF compliant
File formats	Still pictures: JPEG Comments: TXT Movies: MOV (video: H.264/MPEG-4 AVC, audio: LPCM stereo)
Image size (pixels)	<ul style="list-style-type: none"> 16M (high image quality) [4608 × 3456★] 16M [4608 × 3456] 8M [3264 × 2448] 4M [2272 × 1704] 2M [1600 × 1200] VGA [640 × 480] 16:9 (12M) [4608 × 2592] 16:9 (2M) [1920 × 1080] 1:1 (12M) [3456 × 3456]
ISO sensitivity (Standard output sensitivity)	<ul style="list-style-type: none"> ISO 125–1600 ISO 3200 (available in auto mode)
Exposure	
Metering mode	Matrix, center-weighted (digital zoom less than 2×), spot (digital zoom 2× or more)
Exposure control	Programmed auto exposure and exposure compensation (-2.0– +2.0 EV in steps of 1/3 EV)
Shutter	
Speed	<ul style="list-style-type: none"> 1/2000–1 s 1/4000 s (maximum speed during high-speed continuous shooting) 4 s (Fireworks show scene mode)
Aperture	
Range	Electronically-controlled ND filter (-2 AV) selection 2 steps (f/3.3 and f/6.6 [W])
Self-timer	Can be selected from 10 and 2 second durations
Flash	
Range (approx.) (ISO sensitivity: Auto)	[W]: 0.5–5.5 m (1 ft 8 in.–18 ft) [T]: 1.0–3.0 m (3 ft 4 in.–9 ft)
Flash control	TTL auto flash with monitor preflashes

Interface	Hi-Speed USB equivalent
Data Transfer Protocol	Mass storage
HDMI output	Can be selected from Auto , 480p , 720p , and 1080i
I/O terminal	Headset connector, Micro-USB connector HDMI Micro connector (Type D)
GPS	Receiver frequency 1575.42 MHz (C/A code), geodetic system WGS 84
Supported languages for camera menus	Arabic, Chinese (Simplified and Traditional), Czech, Danish, Dutch, English, Finnish, French, German, Greek, Hindi, Hungarian, Indonesian, Italian, Japanese, Norwegian, Polish, Portuguese (European and Brazilian), Romanian, Russian, Spanish, Swedish, Thai, Turkish, Ukrainian, Vietnamese
Power sources	One Rechargeable Li-ion Battery EN-EL23 (included) AC Adapter EH-67A (available separately)
Charging time	Approx. 3 hours 45 minutes (with Charging AC Adapter EH-71P when battery is fully discharged)
Battery life ¹	
Still pictures	Approx. 270 shots when using EN-EL23
Movies (actual battery life for recording) ²	Approx. 1 hour 10 minutes when using EN-EL23
Tripod socket	1/4 (ISO 1222)
Dimensions (W × H × D)	Approx. 113 × 63.5 × 27.5 mm (4.5 × 2.5 × 1.1 in.) (excluding projections)
Weight	Approx. 216 g (7.7 oz) (including battery and memory card)
Operating environment	
Temperature	0°C–40°C (32°F–104°F)
Humidity	85% or less (no condensation)

Wi-Fi (Wireless LAN)	
Standards	IEEE 802.11b/g/n (standard wireless LAN protocol), WPS 2.0 (certified compliant with Wi-Fi Alliance standards), ARIB STD-T66 (standard for low power data communications systems)
Communications protocols	IEEE 802.11b: DBPSK, DQPSK, CCK IEEE 802.11g: OFDM IEEE 802.11n: OFDM
Range	Approx. 60 m (65 yd)
Operating frequency	2412-2462 MHz (1-11 channels)
Data rates (actual measured values)	IEEE 802.11b: 5 Mbps IEEE 802.11g: 20 Mbps IEEE 802.11n: 25 Mbps
Security	WPA/WPA2/WEP
Access protocols	Infrastructure
System	
Processor	Cortex-A9
Memory	Internal storage: Approx. 4 GB RAM: Approx. 1 GB
Operating system	Android 4.2.2

- Unless otherwise stated, all figures assume a fully-charged battery and an ambient temperature of $23 \pm 3^{\circ}\text{C}$ ($73.4 \pm 5.4^{\circ}\text{F}$) as specified by the Camera and Imaging Products Association (CIPA).
 - ¹ Battery life may vary depending on conditions of use, such as the interval between shots or the length of time that menus and images are displayed.
 - ² Individual movie files cannot exceed 4 GB in size or 29 minutes in length. Recording may end before this limit is reached if camera temperature becomes elevated.

Rechargeable Li-ion Battery EN-EL23

Type	Rechargeable lithium-ion battery
Rated capacity	DC 3.8 V, 1850 mAh
Operating temperature	0°C – 40°C (32°F – 104°F)
Dimensions (W × H × D)	Approx. 34.9 × 47 × 10.5 mm (1.4 × 1.9 × 0.5 in.)
Weight	Approx. 34 g (1.2 oz) (excluding terminal cover)

Charging AC Adapter EH-71P

Rated input	AC 100 V–240 V, 50/60 Hz, MAX 0.2 A
Rated output	DC 5.0 V, 1.0 A
Operating temperature	0°C–40°C (32°F–104°F)
Dimensions (W × H × D)	Approx. 55 × 22 × 54 mm (2.2 × 0.9 × 2.2 in.) (excluding plug adapter) For Argentina: Approx. 55 × 63 × 59 mm (2.2 × 2.5 × 2.4 in.) For Brazil: Approx. 55 × 67 × 59 mm (2.2 × 2.7 × 2.4 in.)
Weight	Approx. 48 g (1.7 oz) (excluding plug adapter) For Argentina: Approx. 73 g (2.6 oz) For Brazil: Approx. 70 g (2.5 oz)

Specifications

Nikon will not be held liable for any errors this manual may contain. The appearance of this product and its specifications are subject to change without notice.

Approved Memory Cards

The following microSDHC/microSDXC memory cards have been tested and approved for use in this camera.

- Memory cards with an SD Speed Class rating of 6 or faster are recommended for recording movies. Movie recording may stop unexpectedly when memory cards with a lower Speed Class rating are used.

	microSDHC ¹	microSDXC ²
SanDisk	4 GB, 8 GB, 16GB, 32GB	64 GB
TOSHIBA	4 GB, 8 GB, 16GB, 32GB	–
Panasonic	4 GB, 8 GB, 16GB, 32GB	–
Lexar	4 GB, 8 GB, 16GB, 32GB	–

¹ SDHC compliant. If the memory card will be used with a card reader or similar device, make sure that the device supports SDHC.

² SDXC compliant. If the memory card will be used with a card reader or similar device, make sure that the device supports SDXC.

- Contact the manufacturer for details on the above cards. We cannot guarantee camera performance when using memory cards made by other manufacturers.
- Memory cards with a capacity of more than 64 GB cannot be used with this camera.



AVC Patent Portfolio License

This product is licensed under the AVC Patent Portfolio License for the personal and non-commercial use of a consumer to (i) encode video in compliance with the AVC standard ("AVC video") and/or (ii) decode AVC video that was encoded by a consumer engaged in a personal and non-commercial activity and/or was obtained from a video provider licensed to provide AVC video. No license is granted or shall be implied for any other use. Additional information may be obtained from MPEG LA, L.L.C.

See <http://www.mpegla.com>.

MPEG-4 Visual Patent Portfolio License

This product is licensed under the MPEG-4 Visual Patent Portfolio License for the personal and non-commercial use of a consumer for (i) encoding video in compliance with the MPEG-4 visual standard ("MPEG-4 video") and/or (ii) decoding MPEG-4 video that was encoded by a consumer engaged in a personal and non-commercial activity and/or was obtained from a video provider licensed by MPEG LA to provide MPEG-4 video. No license is granted or shall be implied for any other use. Additional information including that relating to promotional, internal and commercial uses and licensing may be obtained from MPEG LA, L.L.C.

See <http://www.mpegla.com>.

About Open Source Software

This product includes certain open source or other software originating from third parties that is subject to the GNU General Public License (GPL), GNU Library/Lesser General Public License (LGPL) and different and/or additional copyright licenses, disclaimers and notices. The exact terms of GPL, LGPL and some other licenses, disclaimers and notices are available on the menu "About device" in the product.

Nikon offers to provide source code of software licensed under the GPL or LGPL or some other open source licenses allowing source code distribution to you on a CD-ROM for a charge covering the cost of performing such distribution, such as the cost of media, shipping and handling, upon written request to Imaging Company, Nikon corporation, Shin-Yurakucho Bldg., 12-1, Yurakucho 1-chome, Chiyoda-ku, Tokyo 100-8331, Japan.

This offer is valid for a period of three (3) years from the date of the distribution of this product by Nikon.

Trademark Information

- Microsoft, Windows and Windows Vista are either trademarks or registered trademarks of Microsoft Corporation in the United States and/or other countries.
- Macintosh and Mac OS are trademarks or registered trademarks of Apple Inc., in the U.S. and other countries.
- Adobe and Acrobat are trademarks or registered trademarks of Adobe Systems Inc.
- microSDHC logo and microSDXC logo are trademarks of SD-3C, LLC.
- HDMI, HDMI logo and High-Definition Multimedia Interface are trademarks or registered trademarks of HDMI Licensing LLC.

HDMI

- Wi-Fi and the Wi-Fi logo are trademarks or registered trademarks of the Wi-Fi Alliance.
- Google™, the Google logo, Android™, the Android logo, Google Play™, the Google Play logo, Gmail™, Google Calendar™, Google Chrome™, Google+™, Google Maps™, Google Latitude™, Picasa™ and YouTube™ are trademarks or registered trademarks of Google, Inc.
- All other trade names mentioned in this manual or the other documentation included with your Nikon product are the trademarks or registered trademarks of their respective holders.

Index

Symbols

T (Telephoto).....	23
W (Wide-angle).....	23
Special effects mode	42
Easy auto mode.....	34
Auto mode.....	20, 35
Scene mode	37
Smart portrait mode	44
Movie.....	72
Setup menu.....	77, 52
Thumbnail playback.....	1, 65
Playback zoom	1, 64
Help	38
Back button.....	2
Home button	2, 79

MENU Menu button

.....	2, 55, 70, 75, 77, 82
-------	-----------------------

Numerics

24-hour display.....	17
----------------------	----

A

About device	87
AC adapter	72
Accessibility	87
Add account.....	87, 90
Add to/remove from Timeline view	70, 39
AF area mode	56, 34
AF-assist illuminator	77, 56
Airplane mode	86
Android OS.....	79
Aperture value	25
Application	80, 86, 91, 93, 16

Auto flash	48
Auto mode	35
Auto rotate screen.....	9, 86
Autofocus.....	62, 75, 51

B

Backlighting	40
Battery	10, 12, 17, 86
Battery charger.....	13, 72
Battery latch.....	10
Battery level.....	18
Battery-chamber cover	10
Beach	37
Best Shot Selector	31
Black and white copy	37, 39
Blink proof.....	56, 37
Blink warning	77, 58
Brightness.....	86, 62
BSS.....	31

C

Charging AC Adapter	12, 72
Choose date format.....	17
Close-up	37, 39
Cloudy.....	32
Comment	24, 32, 66, 91, 52, 71
Computer	94, 97
Connect to S810c.....	16
Connector cover	1
Continuous.....	56, 30
Continuous H.....	30
Continuous H:120 fps	30
Continuous H:60 fps.....	30

- Continuous L 30
 Copy 71, 47
 Creative slider 36
 Crop 64, 13
 Cross process 42
- D**
- Data usage 86
 Date and time 17, 87, 64
 Daylight 32
 Delete 28
 Digital filter 9
 Digital zoom 23, 77, 56
 Display off 31, 86, 62
 D-Lighting 70, 8
 Drag 4
 DSCN 71
 Dusk/dawn 37
 Dynamic Fine Zoom 23
- E**
- Easy panorama 37, 40, 2
 Edit text 84
 Edit title 69
 EH-71P 12
 EN-EL23 10
 Enter text 83
 Erase location data 70, 39
 Erase SD card 14, 86, 63
 Exposure compensation 52
 Extension 71
 Eyelet for camera strap 1
- E**
- Face detection 61
 Face priority 34
 File names 71
 Fill flash 48
- Filter effects 70, 9
 Fireworks show 37, 39
 Firmware version 78, 60
 Fixed range auto 29
 Flash 47, 32
 Flash mode 47, 48
 Flash off 48
 Flick 5
 Fluorescent 32
 Focus 24, 34
 Focus area 6, 24, 60
 Focus indicator 7, 24
 Focus lock 63
 Food 37, 39
 Format 14, 87, 63, 67
 FSCN 71
 Full-frame playback 26
 Full-time AF 75, 51
- G**
- Google account 16, 90
 Google Play Store 80, 93
 Google Search Bar 82
 GPS 78, 86, 59
- H**
- HDMI 77, 94, 57
 HDMI cable 94, 14
 HDMI Micro connector
 1, 94, 14
 HDR 40
 Headset connector 2, 76, 93
 Help 38
 High key **HI** 42
 High-contrast monochrome 42
 Home screen 79
 HS movie 75, 49























Refer to the *Reference Manual* for pages indicated with .

- I**
- Identifier..... 71
 - Image mode..... 56, 22
 - Image review 77, 52
 - Image size..... 56, 22
 - Imprinting date and time
..... 77, 54
 - Incandescent..... 32
 - Internal memory..... 15
 - Internal memory indicator
..... 6, 8, 18
 - Internet..... 92
 - ISO sensitivity..... 56, 29
- J**
- JPG..... 71
- K**
- Keyboard 84
- L**
- Landscape 37
 - Language..... 67
 - Lens..... 1, 15
 - Lens cover..... 1
 - Location access..... 86, 64
 - Location data 78, 86, 59
 - Low key **LO**..... 42
- M**
- Macro mode..... 51
 - Memory capacity..... 22
 - Memory card..... 14, 20
 - Memory card slot..... 14
 - Memory card slot cover 14
 - Menu effects 77, 52
 - Microphone (stereo)..... 1
 - Micro-USB connector
..... 1, 12, 94, 97
 - Monitor..... 2, 6, 6
 - Monitor settings..... 77, 52
 - Motion detection 25
 - MOV..... 71
 - Movie menu 75, 49
 - Movie options..... 75, 49
 - Movie playback..... 76
 - Multi-shot 16..... 31
- N**
- Night landscape 37
 - Night portrait 39
 - Nikon Transfer 2..... 96, 97
 - Nostalgic sepia **SEPIA**..... 42
 - Notification shade..... 81
 - Number of exposures remaining
..... 22
- O**
- Optical zoom..... 23
 - Option menu 82
 - Optional accessories..... 72
- P**
- Party/indoor 37, 39
 - Pet portrait auto release..... 41
 - Pet portrait 37, 41
 - Photo info..... 77, 52
 - Playback 26, 64, 76
 - Playback menu..... 70, 39
 - Playback mode..... 26
 - Playback zoom 64
 - Pop **POP** 42
 - Portrait 37
 - Power..... 18
 - Power switch..... 1, 3, 18, 30
 - Power-on lamp 1, 13
 - Preset manual..... 32, 33

Refer to the *Reference Manual* for pages indicated with .

Press and hold.....	3	Shooting	20, 22, 24
Press halfway	25	Shooting menu.....	56
Print	43	Shooting mode	21
Print date.....	77, 54	Shut-down timer... 31, 86, 63	
Print order.....	70	Shutter sound.....	77, 57
Protect.....	70, 41	Shutter speed	25
Q		Shutter-release button.....	1, 24
Quick retouch.....	70, 7	Simple setup.....	17
Quick settings.....	81	Single	56, 30
R		Single AF	75, 51
Reboot	3, 87, 67	Skin softening	56, 36
Rechargeable Li-ion battery		Slide show.....	69, 70, 40
.....	10, 12	Slow sync.....	48
Record location data.....	78, 59	Small picture.....	70, 12
Recording movies.....	72	Smart portrait menu.....	36
Recording slow motion movies		Smart portrait mode.....	44
.....	75	Smile timer	56, 38
Red-eye reduction.....	48	Snow 	37
Reset all	78, 60	Soft SOFT	42
Retouch.....	70, 6	Sort	69
Rotate image	70, 46	Speaker	2
RSCN.....	71	Sports 	37, 39
S		SSCN.....	71
Scene effect	38	Stand by mode	30, 31
Scene mode	37, 39	Status bar.....	81
Screen lock.....	79, 87	Strap.....	2
Scroll playback.....	5	Subject tracking	56, 26
Select time zone	17	Sunset 	37
Selective color 	42	Super vivid VI	42
Self-timer	49	Switch the screen.....	81
Self-timer lamp.....	1, 44, 50	I	
Set date	17	Tap.....	4
Set time	17	Target finding AF	60, 35
Setup menu.....	77, 52	Telephoto zoom	23
Share images	91	Thumbnail playback.....	65
		Timeline menu	69

Refer to the *Reference Manual* for pages indicated with .

- Timeline view 66  Z
- Touch AF/AE 56,  28 Zoom control 1, 23
- Touch and hold 4
- Touch shooting
..... 56, 75,  23,  50
- Touch shutter 56,  25
- Touch sounds 86,  62
- Toy camera effect 1  1 43
- Toy camera effect 2  2 43
- Tripod socket 2
- TV 94,  14
- TXT  71
- U**
- Update the A-GPS File
.....  64,  66
- Upload images  16,  19
- Upload to smart device  16
- USB cable 12, 94, 97
- V**
- Vibration reduction 77,  55
- ViewNX 2 95, 96
- Voice typing 32, 85
- Volume 71, 76
- W**
- Welcome screen 77,  52
- White balance 56,  32
- Wide-angle zoom 23
- Wi-Fi 9, 86, 88,  61
- Wi-Fi & mobile network location
.....  64
- Wi-Fi antenna 1
- Wi-Fi settings 16, 88,  61
- Wind Noise Reduction... 75,  51
- Wireless network  61



A series of horizontal dashed lines spanning the width of the page, intended for handwriting practice.

No reproduction in any form of this manual, in whole or in part (except for brief quotation in critical articles or reviews), may be made without written authorization from NIKON CORPORATION.

