

# ***Nikon***

DIGITAL CAMERA

# COOLPIX AW120

## User's Manual

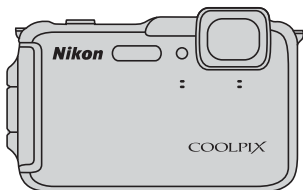

En

# Waterproofing

The following are important notes about the camera's waterproofing. Before using the camera, please thoroughly read the information in "<Important> Shockproof, Waterproof, Dustproof, Condensation" (📖xii).

## Waterproofing-related Messages

The camera will display messages related to its waterproof capabilities when you select certain settings or perform certain operations. Read and follow the information displayed in the messages when they are displayed.

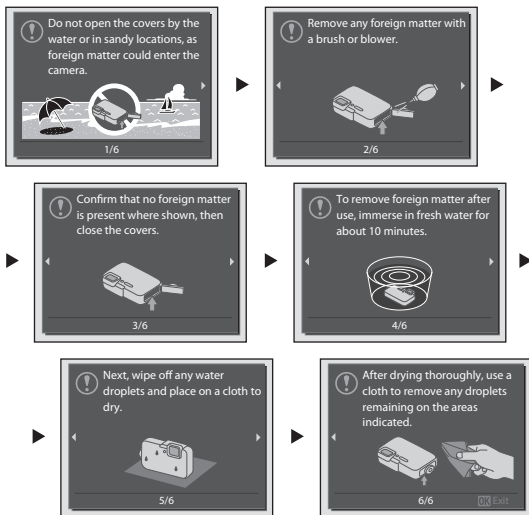

Waterproofing-related messages are displayed in the following situations.

- When turning on and setting the camera for the first time
- When setting the camera to **Underwater** (📖41)
- When turning the camera on after charging

Warning: If the cover is closed without removing foreign particles, water may seep inside the camera or the camera may become damaged. Make sure to check and clean the camera.

<b>Introduction</b>	
<b>Parts of the Camera</b>	
<b>The Basics of Shooting and Playback</b>	
<b>Shooting Features</b>	
<b>Playback Features</b>	
<b>Recording and Playing Back Movies</b>	
<b>General Camera Setup</b>	
<b>Using Location Data Functions/Displaying Maps</b>	
<b>Using the Wi-Fi (Wireless LAN) Function</b>	
<b>Connecting the Camera to a TV, Computer, or Printer</b>	
<b>Technical Notes and Index</b>	

# Introduction

## Read This First

Thank you for purchasing the Nikon COOLPIX AW120 digital camera. Before using the camera, please read the information in "For Your Safety" (📖vii-ix), "<Important> Shockproof, Waterproof, Dustproof, Condensation" (📖xii), "<Important> Notes About Location Data Functions (GPS/GLONASS, Electronic Compass)" (📖xviii), and "Wi-Fi (Wireless LAN Network)" (📖xx), and familiarize yourself with the information provided in this manual. After reading, please keep this manual handy and refer to it to enhance your enjoyment of your new camera.

## Confirming the Package Contents

In the event that any items are missing, please contact the store where you purchased the camera.

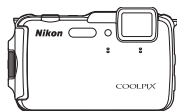

COOLPIX AW120  
Digital Camera



Camera strap for land  
use



Rechargeable Li-ion  
Battery EN-EL12

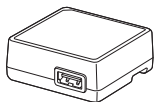

Charging AC Adapter  
EH-71P<sup>1</sup>

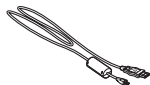

USB Cable UC-E21



Brush<sup>2</sup>

- *User's Manual* (this manual)
- *Warranty*

1 A plug adapter is included if the camera was purchased in a country or region that requires a plug adapter. The shape of the plug adapter varies with the country or region of purchase (📖14).

2 The brush is used for cleaning the waterproof packing.

### NOTES:

- Accessories are not waterproof.
- A memory card is not included with the camera.

## About This Manual

If you want to start using the camera right away, see “The Basics of Shooting and Playback” (📖12).

To learn about the parts of the camera and information that is displayed in the monitor, see “Parts of the Camera” (📖1).

### Downloading the “Reference Manual”

Refer to the *Reference Manual* (PDF format) for more detailed information.

The *Reference Manual* can be downloaded from the Nikon website.







<http://nikonimglib.com/manual/>

The *Reference Manual* can be viewed using Adobe Reader, available for free download from the Adobe website.

### Other Information

- Symbols and Conventions

To make it easier to find the information you need, the following symbols and conventions are used in this manual:

Symbol	Description
	This icon indicates cautions and information that should be read before using the camera.
	This icon indicates notes and information that should be read before using the camera.
  	These icons indicate other pages containing relevant information;  *: “Reference Section”,  : “Technical Notes and Index.”

\* Refer to the *Reference Manual* for pages indicated with .

- SD and SDHC/SDXC memory cards are referred to as “memory cards” in this manual.
- The setting at the time of purchase is referred to as the “default setting.”
- The names of menu items displayed in the camera monitor, and the names of buttons or messages displayed on a computer monitor appear in bold.
- In this manual, images are sometimes omitted from monitor display samples so that monitor indicators can be more clearly shown.
- Illustrations and monitor content shown in this manual may differ from the actual product.

## Information and Precautions

### Life-Long Learning

As part of Nikon's "Life-Long Learning" commitment to ongoing product support and education, continually updated information is available online at the following sites:

- For users in the U.S.A.: <http://www.nikonusa.com/>
- For users in Europe and Africa: <http://www.europe-nikon.com/support/>
- For users in Asia, Oceania, and the Middle East: <http://www.nikon-asia.com/>

Visit these sites to keep up-to-date with the latest product information, tips, answers to frequently asked questions (FAQs), and general advice on digital imaging and photography. Additional information may be available from the Nikon representative in your area. Visit the site below for contact information:

<http://imaging.nikon.com/>

### Use Only Nikon Brand Electronic Accessories

Nikon COOLPIX cameras are designed to the highest standards and include complex electronic circuitry. Only Nikon brand electronic accessories (including battery chargers, batteries, charging AC adapters, AC adapters, and cables) certified by Nikon specifically for use with this Nikon digital camera are engineered and proven to operate within the operational and safety requirements of this electronic circuitry.

**THE USE OF NON-NIKON ELECTRONIC ACCESSORIES COULD DAMAGE THE CAMERA AND MAY VOID YOUR NIKON WARRANTY.**

The use of third-party rechargeable Li-ion batteries not bearing the Nikon holographic seal could interfere with normal operation of the camera or result in the batteries overheating, igniting, rupturing, or leaking.

For more information about Nikon brand accessories, contact a local authorized Nikon dealer.

**Holographic seal:** Identifies this device as an authentic Nikon product.



### Before Taking Important Pictures

Before taking pictures on important occasions (such as at weddings or before taking the camera on a trip), take a test shot to ensure that the camera is functioning normally. Nikon will not be held liable for damages or lost profits that may result from product malfunction.

## About the Manuals

- No part of the manuals included with this product may be reproduced, transmitted, transcribed, stored in a retrieval system, or translated into any language in any form, by any means, without Nikon's prior written permission.
- Nikon reserves the right to change the specifications of the hardware and software described in these manuals at any time and without prior notice.
- Nikon will not be held liable for any damages resulting from the use of this product.
- While every effort was made to ensure that the information in these manuals is accurate and complete, we would appreciate it were you to bring any errors or omissions to the attention of the Nikon representative in your area (address provided separately).

## Notice Concerning Prohibition of Copying or Reproduction

Note that simply being in possession of material that was digitally copied or reproduced by means of a scanner, digital camera or other device may be punishable by law.

### • **Items prohibited by law from being copied or reproduced**

Do not copy or reproduce paper money, coins, securities, government bonds or local government bonds, even if such copies or reproductions are stamped "Sample." The copying or reproduction of paper money, coins, or securities which are circulated in a foreign country is prohibited. Unless the prior permission of the government was obtained, the copying or reproduction of unused postage stamps or post cards issued by the government is prohibited.

The copying or reproduction of stamps issued by the government and of certified documents stipulated by law is prohibited.

### • **Cautions on certain copies and reproductions**

The government has issued cautions on copies or reproductions of securities issued by private companies (shares, bills, checks, gift certificates, etc.), commuter passes, or coupon tickets, except when a minimum of necessary copies are to be provided for business use by a company. Also, do not copy or reproduce passports issued by the government, licenses issued by public agencies and private groups, ID cards and tickets, such as passes and meal coupons.

### • **Comply with copyright notices**

The copying or reproduction of copyrighted creative works such as books, music, paintings, woodcut prints, maps, drawings, movies, and photographs is governed by national and international copyright laws. Do not use this product for the purpose of making illegal copies or to infringe copyright laws.

## Disposing of Data Storage Devices

Please note that deleting images or formatting data storage devices such as memory cards or built-in camera memory does not completely erase the original image data. Deleted files can sometimes be recovered from discarded storage devices using commercially available software, potentially resulting in the malicious use of personal image data. Ensuring the privacy of such data is the user's responsibility.

Before discarding a data storage device or transferring ownership to another person, erase all data using commercial deletion software, or set **Record location data** of **Location data options** (📖87) to **Off** after formatting the device and then completely refill it with images containing no private information (for example, pictures of empty sky). Be sure to also replace any pictures selected for the **Select an image** option in the **Welcome screen** setting (📖76). Care should be taken to avoid injury or damage to property when physically destroying data storage devices.

For the COOLPIX AW120, the log data saved on the memory card is handled in the same way as other data. To erase the log data that is obtained but not stored on the memory card, select **Create log** → **End all logs** → **Erase logs**.

You can clear the Wi-Fi setting using **Restore default settings** in the Wi-Fi options (🔌92) menu.

## For Your Safety

To prevent damage to your Nikon product or injury to yourself or to others, read the following safety precautions in their entirety before using this equipment. Keep these safety instructions where all those who use the product will read them.

The consequences that could result from failure to observe the precautions listed in this section are indicated by the following symbol:



This icon marks warnings, information that should be read before using this Nikon product, to prevent possible injury.

### WARNINGS

#### **Turn off in the event of malfunction**

Should you notice smoke or an unusual smell coming from the camera or charging AC adapter, unplug the charging AC adapter and remove the battery immediately, taking care to avoid burns. Continued operation could result in injury. After removing or disconnecting the power source, take the equipment to a Nikon-authorized service representative for inspection.

#### **Do not disassemble**

Touching the internal parts of the camera or charging AC adapter could result in injury. Repairs should be performed only by qualified technicians. Should the camera or charging AC adapter break open as the result of a fall or other accident, take the product to a Nikon-authorized service representative for inspection, after unplugging the product and/or removing the battery.

#### **Do not use the camera or charging AC adapter in the presence of flammable gas**

Do not use electronic equipment in the presence of flammable gas, as this could result in explosion or fire.

#### **Remove the strap when using the camera underwater**

Twisting the camera strap around the neck may cause suffocation.

#### **Handle the camera strap with care**

Never place the strap around the neck of an infant or child.

#### **Keep out of reach of children**

Particular care should be taken to prevent infants from putting the battery or other small parts into their mouths.

**⚠ Do not remain in contact with the camera, charging AC adapter, or AC adapter for extended periods while the devices are on or in use**

Parts of the devices become hot. Leaving the devices in direct contact with the skin for extended periods may result in low-temperature burns.

**⚠ Do not leave the product where it will be exposed to extremely high temperatures, such as in an enclosed automobile or in direct sunlight**

Failure to observe this precaution could cause damage or fire.

**⚠ Use the appropriate power supply (battery, charging AC adapter, AC adapter, USB cable)**

Using a power supply other than those provided or sold by Nikon could result in damage or malfunction.

**⚠ Observe caution when handling the battery**

The battery may leak, overheat, or explode if improperly handled. Observe the following precautions when handling the battery for use in this product:

- Before replacing the battery, turn the product off. If you are using the charging AC adapter/AC adapter, be sure it is unplugged.
- Use only a Rechargeable Li-ion Battery EN-EL12 (included). Charge the battery by using a camera that supports battery charging. To perform this operation, use the Charging AC Adapter EH-71P (included) and

USB Cable UC-E21 (included). The Battery Charger MH-65 (available separately) is also available to charge the battery without using a camera.

- When inserting the battery, do not attempt to insert it upside down or backwards.
- Do not short or disassemble the battery or attempt to remove or break the battery insulation or casing.
- Do not expose the battery to flame or to excessive heat.
- Do not immerse in or expose to water.
- Put the battery in a plastic bag, etc. to insulate the terminal before transporting it. Do not transport or store with metal objects such as necklaces or hairpins.
- The battery is prone to leakage when fully discharged. To avoid damage to the product, be sure to remove the battery when no charge remains.
- Discontinue use immediately should you notice any change in the battery, such as discoloration or deformation.
- If liquid from the damaged battery comes in contact with clothing or skin, rinse immediately with plenty of water.

**⚠ Observe the following precautions when handling the charging AC adapter**

- Keep dry. Failure to observe this precaution could result in fire or electric shock.
- Dust on or near the metal parts of the plug should be removed with a dry cloth. Continued use could result in fire.

- Do not handle the plug or go near the charging AC adapter during lightning storms. Failure to observe this precaution could result in electric shock.
- Do not damage, modify, forcibly tug or bend the USB cable, place it under heavy objects, or expose it to heat or flames. Should the insulation be damaged and the wires become exposed, take it to a Nikon-authorized service representative for inspection. Failure to observe these precautions could result in fire or electric shock.
- Do not handle the plug or charging AC adapter with wet hands. Failure to observe this precaution could result in electric shock.
- Do not use with travel converters or adapters designed to convert from one voltage to another or with DC-to-AC inverters. Failure to observe this precaution could damage the product or cause overheating or fire.

 **Use appropriate cables**

When connecting cables to the input and output jacks, use only the cables provided or sold by Nikon for the purpose, to maintain compliance with product regulations.

 **Handle moving parts with care**

Be careful that your fingers or other objects are not pinched by the lens cover or other moving parts.

 **Using the flash close to your subject's eyes could cause temporary visual impairment**

The flash should be no less than 1 m (3 ft 4 in.) from the subject. Particular care should be observed when photographing infants.

 **Do not operate the flash with the flash window touching a person or object**

Failure to observe this precaution could result in burns or fire.

 **Turn the power off when using inside an airplane or the hospital**

Turn the power off while inside the airplane during take off or landing. Before boarding an airplane, set the record location data function to OFF. End recording of all logs. Do not use wireless network functions while in the air. Follow the instructions of the hospital when using while in a hospital. The electromagnetic waves emitted by this camera may disrupt the electronic systems of the airplane or the instruments of the hospital. If you are using an Eye-Fi card, remove it from the camera before boarding an aircraft or entering a hospital.

 **Do not touch the camera directly for a long time in low temperatures of 0°C (32°F) or lower**

If the skin contacts metal parts etc., it may result in injury to the skin. Wear gloves etc.

 **Observe caution when using the movie light**

Do not look directly into the movie light. This could damage the eyes or result in visual impairment.

# Notices

## Notices for Customers in the U.S.A.

### **IMPORTANT SAFETY INSTRUCTIONS -**

### **SAVE THESE INSTRUCTIONS.**

### **DANGER - TO REDUCE THE RISK OF FIRE OR ELECTRIC SHOCK, CAREFULLY FOLLOW THESE INSTRUCTIONS**

For connection to a supply not in the U.S.A., use an attachment plug adapter of the proper configuration for the power outlet if needed.

The power supply unit is intended to be correctly orientated in a vertical or floor mount position.

### **Federal Communications Commission (FCC) Radio Frequency Interference Statement**

This equipment has been tested and found to comply with the limits for a Class B digital device, pursuant to Part 15 of the FCC Rules. These limits are designed to provide reasonable protection against harmful interference in a residential installation. This equipment generates, uses, and can radiate radio frequency energy and, if not installed and used in accordance with the instructions, may cause harmful interference to radio communications. However, there is

no guarantee that interference will not occur in a particular installation. If this equipment does cause harmful interference to radio or television reception, which can be determined by turning the equipment off and on, the user is encouraged to try to correct the interference by one or more of the following measures:

- Reorient or relocate the receiving antenna.
- Increase the separation between the equipment and receiver.
- Connect the equipment into an outlet on a circuit different from that to which the receiver is connected.
- Consult the dealer or an experienced radio/TV technician for help.



*Nikon*

COOLPIX AW120

## **CAUTIONS**

### **Modifications**

The FCC requires the user to be notified that any changes or modifications made to this device that are not expressly approved by Nikon Corporation may void the user's authority to operate the equipment.

## Interface Cables

Use the interface cables sold or provided by Nikon for your equipment. Using other interface cables may exceed the limits of Class B Part 15 of the FCC Rules.

## Notice for customers in the State of California

### WARNING

Handling the cord on this product will expose you to lead, a chemical known to the State of California to cause birth defects or other reproductive harm.

### ***Wash hands after handling.***

Nikon Inc.,  
1300 Walt Whitman Road  
Melville, New York 11747-3064  
USA  
Tel: 631-547-4200

## Notice for customers in Canada

CAN ICES-3 B / NMB-3 B

## Notices for customers in Europe

### CAUTIONS

### **RISK OF EXPLOSION IF BATTERY IS REPLACED BY AN INCORRECT TYPE.**

### **DISPOSE OF USED BATTERIES ACCORDING TO THE INSTRUCTIONS.**

This symbol indicates that electrical and electronic equipment is to be collected separately.



The following apply only to users in European countries:

- This product is designated for separate collection at an appropriate collection point. Do not dispose of as household waste.
- Separate collection and recycling helps conserve natural resources and prevent negative consequences for human health and the environment that might result from incorrect disposal.
- For more information, contact the retailer or the local authorities in charge of waste management.

This symbol on the battery indicates that the battery is to be collected separately.



The following apply only to users in European countries:

- All batteries, whether marked with this symbol or not, are designated for separate collection at an appropriate collection point. Do not dispose of as household waste.
- For more information, contact the retailer or the local authorities in charge of waste management.

## <Important> Shockproof, Waterproof, Dustproof, Condensation

- Make sure to read the following instructions as well as the instructions provided in “Caring for the Product” (P.2).

### Notes About Shockproof Performance

This camera has passed Nikon’s in-house test (drop test from a height of 202 cm (6 ft 6 in.) on a 5 cm (2 in.) thick plywood panel) compliant with MIL-STD 810F Method 516.5-Shock\*.

This test does not guarantee the waterproof performance of the camera or that the camera will be free from damage or trouble under all conditions.

Changes in appearance, such as paint peeling off and deformation of the drop shock portion are not subject to the Nikon’s in-house test.

\* U.S. Department of Defense test method standard.

This drop test drops 5 cameras in 26 directions (8 edges, 12 corners, and 6 faces) from a height of 122 cm (48 in.) to make sure that one to five cameras pass the test (if any defect is detected during the test, another five cameras are tested to make sure that the test criteria are satisfied for one to five cameras).

### ● Do not subject the camera to excessive shock, vibration or pressure by dropping or hitting it.

Failure to observe this precaution could cause water to seep inside the camera and result in camera malfunction.

- Do not use the camera deeper than 18 m (59 ft) underwater.
- Do not subject the camera to water pressure by exposing it to running water.
- Do not sit down with the camera in the pocket of your trousers.  
Do not forcibly stuff the camera into a bag.

### Notes About Waterproof and Dustproof Performances

The camera is equivalent to JIS/IEC waterproof grade 8 (IPX8) and JIS/IEC dustproof grade 6 (IP6X) and enables shooting images underwater at a depth of 18 m (59 ft) for up to 60 minutes.\*

This rating does not guarantee the waterproof performance of the camera or that the camera will be free from damage or trouble under all conditions.

\* This rating indicates that the camera has been designed to withstand the specified water pressure for the specified period of time when the camera is used according to the methods defined by Nikon.

● **If the camera is subjected to excessive shock, vibration or pressure by dropping or hitting it, the waterproof performance is not guaranteed.**

- If the camera is exposed to shocks, it is recommended to consult your retailer or Nikon-authorized service representative to confirm the waterproof performance (charged service).
  - Do not use the camera deeper than 18 m (59 ft) underwater.
  - Do not subject the camera to water pressure by exposing it to rapids or waterfalls.
  - Your Nikon warrantee may not cover troubles caused by water seeping inside the camera due to improper handling of the camera.
- The waterproof performance of this camera is designed to work for fresh water (swimming pools, rivers and lakes) and seawater only.
- The inner portion of this camera is not waterproof. Water seeping inside the camera could cause a malfunction.

- Accessories are not waterproof.
- If a liquid such as water droplets falls on the outside of the camera or inside of the battery-chamber/memory card slot cover, immediately wipe it off with a soft dry cloth. Do not insert a wet memory card or battery in the camera.

If the battery-chamber/memory card slot cover is opened or closed under wet conditions near a waterfront or underwater, this could

cause water to seep inside the camera or result in camera malfunction.

Do not open or close the cover with wet hands. This could cause water to seep inside the camera or result in camera malfunction.

- If a foreign substance adheres to the outside of the camera or inside of the battery-chamber/memory card slot cover (in locations such as yellow waterproof packing, hinges, memory card slot, or terminals), immediately remove it with a blower. If a foreign substance adheres to the waterproof packing inside of the battery-chamber/memory card slot cover, remove it with the included brush. Do not use the included brush for anything other than cleaning the waterproof packing.
- If a foreign substance such as suntan oil, sunscreen lotion, hot spring, bath mix powder, detergent, soap, organic solvent, oil, or alcohol adheres to the camera, immediately wipe it off.
- Do not leave the camera in low temperature conditions in cold climate regions or in high-temperature conditions of 40°C (104°F) or more (in particular, a place exposed to direct sunlight, inside the cabin of a car, on a boat, on the beach, or near heating apparatus) for a long period of time. This could cause deterioration of the waterproof performance.

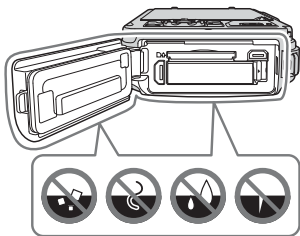

## Before Using the Camera Underwater

Remove the strap for land use before using the camera underwater.

### 1. Make sure that there are no foreign substances inside the battery-chamber/memory card slot cover.

- Any foreign substances such as sand, dust or hair inside the battery-chamber/memory card slot cover should be removed with a blower.
- Any liquid such as water droplets inside the battery-chamber/memory card slot cover should be wiped off with a soft dry cloth.

### 2. Make sure that the waterproof packing (📖1) of the battery-chamber/memory card slot cover is not cracked or deformed.

- The waterproof performance of waterproof packing may start to deteriorate after one year.  
If the waterproof packing begins to deteriorate, consult your retailer or Nikon-authorized service representative.

### 3. Make sure that the battery-chamber/memory card slot cover is firmly closed.

- Rotate the battery-chamber/memory card slot cover latch until it clicks into place. Make sure that the thin cord of the camera strap does not get caught.
- Make sure that the latch indicator indicates the “Close” status.

## Notes About Using the Camera Underwater

### Observe the following precautions to prevent water from seeping inside the camera.

- Do not dive into water deeper than 18 m (59 ft) with the camera.
- Do not continuously use the camera underwater for 60 minutes or more.
- Use the camera in the water temperature range from 0°C to 40°C (32°F to 104°F) when using it underwater.
- Do not use the camera at hot springs.
- Do not open or close the battery-chamber/memory card slot cover underwater.
- Do not subject the camera to shock when using it underwater.  
Do not jump into water with the camera or subject it to high water pressure conditions such as rapids or waterfalls.
- This camera does not float in water. Make sure not to drop the camera underwater.

## Cleaning after Using the Camera Underwater

- After using the camera underwater, clean the camera within 60 minutes. If you leave the camera in wet conditions where salt particles or other foreign substances are adhered to it, this could cause damage, discoloration, corrosion, a bad smell or deterioration of waterproof performance.
- Before cleaning the camera, thoroughly remove water droplets, sand, salt particles, or other foreign substances from your hands, body, and hair.
- It is recommended to clean the camera indoors to avoid a place where it could be exposed to water spray or sand.
- Do not open the battery-chamber/memory card slot cover until all foreign substances are washed off with water and all moisture is wiped off.

### 1. Keep the battery-chamber/memory card slot cover closed and wash off the camera with fresh water.

Immerse the camera in a shallow basin filled with fresh water (such as tap water and well-water that do not contain salt) for 10 minutes.

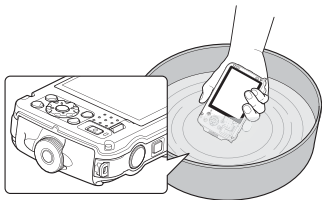

- If the buttons or switches do not operate properly, foreign substances may have adhered. Since this could cause a malfunction, immerse the camera in fresh water and shake it sufficiently in the water to remove the any foreign substances from the camera.
- When the camera is immersed in the water, a few air bubbles may come out from the water drain holes of the camera such as openings in the microphone or speakers. This is not a malfunction.

### 2. Wipe off water droplets with a soft cloth and dry the camera in the well-ventilated and shady place.

- Place the camera on a dry cloth to dry it.  
Water will flow out from openings in the microphone or speakers.
- Do not dry the camera with hot air from a hair dryer or clothes dryer.
- Do not use chemicals (such as benzine, thinner, alcohol, or cleanser), soap, or neutral detergents.

If the waterproof packing or body of the camera becomes deformed, the waterproof performance will deteriorate.

**3. After making sure that there are no water droplets on the camera, open the battery-chamber/memory card slot cover and gently wipe off any water or sand remaining inside the camera with a dry soft cloth.**

- If you open the cover before the camera is thoroughly dried, water droplets may fall on a memory card or battery.

The water droplets may also seep inside the battery-chamber/memory card slot cover (in locations such as waterproof packing, hinges, memory card slot, or terminals).

If that happens, wipe the water off with a dry soft cloth.

- If the cover is closed when the inside is wet, this could cause condensation or malfunction.
- If the microphone or speaker openings are clogged with water droplets, the sound may deteriorate or become distorted.
  - Wipe the water off with a dry soft cloth.
  - Do not puncture the microphone or speaker openings with a sharp implement. If the inside of the camera is damaged, the waterproof performance will deteriorate.
- See “Cleaning” (🔧:7) for more information.

## Notes About Operating Temperature and Humidity and Condensation

The operation of this camera has been tested at temperatures from  $-10^{\circ}\text{C}$  to  $+40^{\circ}\text{C}$  ( $14^{\circ}\text{F}$  to  $104^{\circ}\text{F}$ ).

When you use the camera in cold climate regions, observe the following precautions. Keep the camera and spare batteries in a warm place before use.

- The performance of the batteries (number of images shot and shooting time) will drop temporarily.
- If the camera is in a very cold state, the performance may drop temporarily, for example, the monitor may be darker than normal immediately after the camera is turned on or residual images may be produced.
- When snow or water droplets adhere to the exterior of the camera, immediately wipe them off.
  - If the buttons or switches are frozen, they may not operate smoothly.
  - If the microphone or speaker openings are clogged with water droplets, the sound may deteriorate or become distorted.

- **Operating environmental conditions such as temperature and humidity may cause fogging (condensation) on the inside of the monitor or lens. This is not the camera malfunction or defect.**

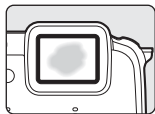

- **Environmental conditions that are likely to cause condensation inside of the camera**

Fogging (condensation) may occur on the inside of the monitor or lens in the following environmental conditions where there are sharp temperature changes or high humidity.

- The camera is suddenly immersed in low temperature underwater from high temperature on land.
- The camera is brought to a warm place such as inside a building from the cold climate outside.
- The battery-chamber/memory card slot cover is opened or closed in a high-humidity environment.

- **Clearing the fogging**

- Open the battery-chamber/memory card slot cover after turning off the camera in a place where the ambient temperature is stable (avoid any place that has high-temperature/high-humidity, sand or dust).  
To clear the fogging, remove the battery and memory card, and leave the camera with the battery-chamber/memory card slot cover open to allow the camera to adjust to the ambient temperature.
- If the fogging does not clear, consult your retailer or Nikon-authorized service representative.

# <Important> Notes About Location Data Functions (GPS/GLONASS, Electronic Compass)

## ● Map/location name data of this camera

Before using the location data functions, make sure to read “USER LICENSE AGREEMENT FOR MAP DATA AND LOCATION NAME DATA” (P.20) and agree to the terms.

- The maps and location name information (Points of Interest: POI) are as of April 2013.  
The maps and location name information will not be updated.
- The details of geological formations are displayed simplistically according to the scale of a map. The scale of a map and level of detail of the location data vary depending on country and region.  
If the latitude becomes higher, the horizontal and vertical scales displayed on the monitor vary, therefore displayed geological formations differ from the actual formations. Use the maps and location name information only as a guide.
- The detailed map data and location name information (Points of Interest: POI) of the People’s Republic of China (“China”) and the Republic of Korea are not provided for the COOLPIX AW120.

## ● Notes about record location data functions and log recording

- When **Record location data** in **Location data options** of the Location data options menu is set to **On** or while recording logs, record location data functions and log recording will continue to operate even after the camera is turned off (P.80).  
The electromagnetic waves emitted by this camera may disrupt the electronic systems of the airplane or the instruments of the hospital. When use of the camera is prohibited or restricted during airplane takeoffs and landings or inside a hospital, end log recording, set **Record location data** to **Off**, and then turn off the camera.
- An individual may be identified from still images or movies that have been recorded with location data. Observe caution when you transfer still images or movies recorded with location data, or log files to a third party or upload them to a network such as the Internet where the public can view them. Make sure to read “Disposing of Data Storage Devices” (P.vi).

## ● Notes about measurement functions

The COOLPIX AW120 is a camera. Do not use this camera as a navigation device or measuring instrument.

- Use information (such as direction, altitude and water depth) measured by the camera as a guideline only. Do not use this information for navigation of an airplane, car, and person or land survey applications.
- When you use the camera for mountain climbing, trekking, or underwater, make sure to take a map, navigation device, or measuring instrument separately.

## ● Using the camera overseas

- Before taking the camera with location data functions overseas for travel, consult your travel agency or embassy of the country you are visiting to confirm whether there is any restriction on use.  
For example, you cannot record location data logs without permission from the government in China.  
Set **Record location data** to **Off**.
- The location data may not function properly in China and on the borders between China and neighboring countries (as of December 2013).

## Wi-Fi (Wireless LAN Network)

This product is controlled by the United States Export Administration Regulations, and you are required to obtain permission from the United States government if you export or re-export this product to any country to which the United States embargoes goods. The following countries were subject to embargo: Cuba, Iran, North Korea, Sudan, and Syria. Since the target countries are subject to change, please contact the United States Department of Commerce for the latest information.

### **Restrictions on Wireless Devices**

The wireless transceiver included in this product conforms to wireless regulations in the country of sale and is not for use in other countries (products purchased in the EU or EFTA can be used anywhere within the EU and EFTA). Nikon does not accept liability for use in other countries. Users who are unsure as to the original country of sale should consult with their local Nikon service center or Nikon-authorized service representative. This restriction applies to wireless operation only and not to any other use of the product.

### **Notice for Customers in the U.S.A. and Canada**

#### **Federal Communications Commission (FCC) and Industry of Canada (IC)**

#### **Declaration of Conformity**

This device complies with Part 15 of FCC Rules and Industry Canada licence-exempt RSS standard(s). Operation is subject to the following two conditions: (1) this device may not cause interference, and (2) this device must accept any interference, including interference that may cause undesired operation of this device.

#### **FCC/IC RF Exposure Statement**

This transmitter must not be co-located or operated in conjunction with any other antenna or transmitter.

The available scientific evidence does not show that any health problems are associated with using low power wireless devices. There is no proof, however, that these low power wireless devices are absolutely safe. Low power wireless devices emit low levels of radio frequency energy (RF) in the microwave range while being used. Whereas high levels of RF can produce health effects (by heating tissue), exposure to low-level RF that does not produce heating effects causes no known adverse health effects. Many studies of low-level RF exposures have not found any biological effects. Some studies have suggested that some biological effects might occur, but such findings have not been confirmed by additional research.

COOLPIX AW120, which is equipped with a DW092 (FCC ID:EW4DW092/IC ID:4634A-3149EC) Wireless LAN Module, has been tested and found to comply with FCC/IC radiation exposure limits set forth for an uncontrolled environment and meets the FCC radio frequency (RF) Exposure Guidelines in Supplement C to OET65 and RSS-102 of the IC radio frequency (RF) Exposure rules. Please refer to the SAR test report that was uploaded to FCC website.

### **Declaration of Conformity (Europe)**

Hereby, Nikon Corporation, declares that COOLPIX AW120 is in compliance with the essential requirements and other relevant provisions of Directive 1999/5/EC. The declaration of conformity may be consulted at [http://imaging.nikon.com/support/pdf/DoC\\_AW120.pdf](http://imaging.nikon.com/support/pdf/DoC_AW120.pdf).

### **Notice for customers in Singapore**

This device complies with radio-frequency regulations.

Complies with IDA Standards DA103423
--

### **Notice for Customers in Jamaica**

This product contains a Type Approved Module by Jamaica:  
"SMA - DW092"

## **הודעה ללקוחות במדינת ישראל**

ההתקן תואם לתקנות תדרי רדיו.

יש לנהוג באמצעי זהירות בעת השימוש באפשרויות התקשורת

א. נקודות הגישה תהיה מיועדת אך ורק לחיבור משתמש תמצוי בחצרים מתוחמים (דוגמת בית, בית עסק, מתחם שדה תעופה, קמפוס אוניברסיטאי וכ'י

ב. לצורך גישה לאינטרנט, נקודת הגישה תקושר מחוץ לחצרים אך ורק אל בעל רשיון למתן שירות גישה לאינטרנט (ISP, להלן-ספק אינטרנט). הקישור לספק אינטרנט יהיה אך ורק באמצעות קו תקשורת נתונים המסופק בידי בעל רשיון למתן שירותי תקשורת נתונים;

ג. קישור נקודת הגישה מחוץ לחצרים לצורך תקשורת נתונים ייעשה באמצעות תשתיות של בעל רשיון מתאים ובלבד שלא ייעשה שימוש בקישור כאמור לצורך העברת קול (VOICE)

ד. לצורך שרות לצד ג' נדרש רשיון נוסף מאגף הנדסה ורישוי (משרד התקשורת).

## Precautions when Using Radio Transmissions

Always keep in mind that radio transmission or reception of data is subject to interception by third parties. Note that Nikon is not responsible for data or information leaks that may occur during data transfer.



## Personal Information Management and Disclaimer

- User information registered and configured on the product, including wireless LAN connection settings and other personal information, is susceptible to alteration and loss resulting from operational error, static electricity, accident, malfunction, repair or other handling. Always keep separate copies of important information. Nikon is not responsible for any direct or indirect damages or lost profits resulting from alteration or loss of content that is not attributable to Nikon.
- Before discarding this product or transferring it to another owner, perform **Restore default settings** in the Wi-Fi options menu (0-092) to delete all user information registered and configured with the product, including wireless LAN connection settings and other personal information.









# Table of Contents

Introduction .....	ii
Read This First .....	ii
Confirming the Package Contents.....	ii
About This Manual.....	iii
Information and Precautions.....	iv
For Your Safety .....	vii
WARNINGS.....	vii
Notices.....	x
<Important> Shockproof, Waterproof, Dustproof, Condensation.....	xii
Notes About Shockproof Performance.....	xii
Notes About Waterproof and Dustproof Performances .....	xii
Before Using the Camera Underwater.....	xiv
Notes About Using the Camera Underwater .....	xiv
Cleaning after Using the Camera Underwater.....	xv
Notes About Operating Temperature and Humidity and Condensation .....	xvii
<Important> Notes About Location Data Functions (GPS/GLONASS, Electronic Compass) .....	xviii
Wi-Fi (Wireless LAN Network).....	xx
<hr/>	
Parts of the Camera .....	1
The Camera Body.....	1
Attaching the Camera Strap for Land Use.....	3
Using the  (Action) Button (Action Control).....	4
Using Menus (the MENU Button).....	6
The Monitor .....	8
Shooting Mode .....	8
Playback Mode .....	10
<hr/>	
The Basics of Shooting and Playback.....	12
Preparation 1 Insert the Battery .....	12
Preparation 2 Charge the Battery .....	14
Preparation 3 Insert a Memory Card.....	16
Internal Memory and Memory Cards.....	17
Preparation 4 Setting the Display Language, Date, and Time .....	18
Step 1 Turn the Camera On.....	22
Step 2 Select a Shooting Mode.....	24

Refer to the *Reference Manual* for pages indicated with .

Available Shooting Modes .....	25
<b>Step 3 Frame a Picture</b> .....	<b>26</b>
Using the Zoom .....	27
<b>Step 4 Focus and Shoot</b> .....	<b>28</b>
The Shutter-release Button .....	29
<b>Step 5 Play Back Images</b> .....	<b>30</b>
<b>Step 6 Delete Images</b> .....	<b>31</b>
<hr/>	
<b>Shooting Features</b> .....	<b>33</b>
 (Easy Auto) Mode .....	33
Scene Mode (Shooting Suited to Scenes) .....	35
Tips and Notes .....	36
Special Effects Mode (Applying Effects When Shooting) .....	42
Smart Portrait Mode (Capturing Images of Smiling Faces) .....	44
 (Auto) Mode .....	45
Using Quick Effects .....	46
<b>Functions That Can Be Set Using the Multi Selector</b> .....	<b>47</b>
Using the Flash .....	48
Using the Self-timer .....	50
Using Macro Mode .....	51
Adjusting Brightness (Exposure Compensation) .....	52
Default Settings .....	53
<b>Functions That Can Be Set with the MENU Button (Shooting Menu)</b> .....	<b>55</b>
Options Available in the Shooting Menu .....	56
<b>Functions That Cannot Be Used Simultaneously</b> .....	<b>58</b>
<b>Focusing</b> .....	<b>61</b>
Using Target Finding AF .....	61
Using Face Detection .....	62
Using Skin Softening .....	63
Subjects Not Suitable for Autofocus .....	63
Focus Lock .....	64
<hr/>	
<b>Playback Features</b> .....	<b>65</b>
Playback Zoom .....	65
Thumbnail Playback, Calendar Display .....	66
<b>Functions That Can Be Set with the MENU Button (Playback Menu)</b> .....	<b>67</b>
<hr/>	
<b>Recording and Playing Back Movies</b> .....	<b>69</b>
Recording Movies .....	69

Refer to the *Reference Manual* for pages indicated with .











Functions That Can Be Set with the <b>MENU</b> Button (Movie Menu) .....	73
Playing Back Movies .....	74
<hr/>	
General Camera Setup.....	76
Functions That Can Be Set with the <b>MENU</b> Button (Setup Menu) .....	76
<hr/>	
Using Location Data Functions/Displaying Maps .....	78
Starting Location Data Recording .....	78
Displaying Maps.....	82
When Using Shooting Mode.....	82
When Using Playback Mode.....	84
Using Altimeter and Depth Gauge.....	86
Functions That Can Be Set Using the <b>MENU</b> Button (Location Data Options Menu) .....	87
<hr/>	
Using the Wi-Fi (Wireless LAN) Function .....	89
Functions That Can Be Performed Using Wi-Fi.....	89
Take Photos .....	89
View Photos.....	89
Installing the Software on the Smart Device .....	89
Connecting the Smart Device to the Camera.....	90
<hr/>	
Connecting the Camera to a TV, Computer, or Printer.....	92
Connection Methods.....	92
Using ViewNX 2 .....	94
Installing ViewNX 2 .....	94
Transferring Images to the Computer .....	95
Viewing Images.....	97
<hr/>	
Reference Section .....	 01
<hr/>	
Using Easy Panorama (Shooting and Playback) .....	 02
Shooting with Easy Panorama.....	 02
Viewing Images Captured with Easy Panorama.....	 04
Favorite Pictures Mode.....	 05
Adding Images to Albums .....	 05
Playing Back Images in Albums .....	 06
Removing Images from Albums.....	 07
Changing the Favorites Album Icon.....	 08

Refer to the *Reference Manual* for pages indicated with .

Auto Sort Mode .....	🔗9
List by Date Mode.....	🔗10
Viewing and Deleting Images Captured Continuously (Sequence).....	🔗11
Viewing Images in a Sequence .....	🔗11
Deleting Images in a Sequence .....	🔗12
Editing Still Images.....	🔗13
Before Editing Images .....	🔗13
Quick Effects: Changing Hue or Mood .....	🔗14
Quick Retouch: Enhancing Contrast and Saturation .....	🔗15
D-Lighting: Enhancing Brightness and Contrast .....	🔗15
Red-eye Correction: Correcting Red-eye When Shooting with the Flash....	🔗16
Glamour Retouch: Enhancing Human Faces.....	🔗17
Data Imprint: Imprinting Information such as Altitude and Direction	
Measured by the Electronic Compass on Images .....	🔗18
Small Picture: Reducing the Size of an Image.....	🔗19
Crop: Creating a Cropped Copy .....	🔗20
Connecting the Camera to a TV (Viewing Images on a TV) .....	🔗21
Connecting the Camera to a Printer (Direct Print).....	🔗22
Connecting the Camera to a Printer.....	🔗23
Printing Individual Images.....	🔗24
Printing Multiple Images.....	🔗26
Editing Movies .....	🔗28
Extracting Only the Desired Portion of a Movie.....	🔗28
Saving a Frame from a Movie as a Still Image .....	🔗29
The Shooting Menu (for 📷 (Auto) Mode) .....	🔗30
Image Mode Settings (Image Size and Quality).....	🔗30
White Balance (Adjusting Hue) .....	🔗32
Continuous Shooting.....	🔗34
ISO Sensitivity .....	🔗37
AF Area Mode.....	🔗38
Autofocus Mode.....	🔗41
Quick Effects .....	🔗41
The Smart Portrait Menu.....	🔗42
Skin Softening .....	🔗42
Smile Timer .....	🔗43
Blink Proof.....	🔗44
The Playback Menu .....	🔗45
Print Order (Creating a DPOF Print Order) .....	🔗45
Slide Show .....	🔗48
Protect.....	🔗49

Refer to the *Reference Manual* for pages indicated with 🔗.

Rotate Image.....	50
Voice Memo .....	51
Copy (Copy Between Internal Memory and Memory Card).....	52
Sequence Display Options .....	53
Choose Key Picture .....	53
<b>The Movie Menu .....</b>	<b>54</b>
Movie Options.....	54
Open with HS Footage .....	58
AF Area Mode .....	58
Autofocus Mode.....	59
Movie VR.....	60
Movie Light .....	60
Wind Noise Reduction .....	61
Frame Rate .....	61
<b>The Setup Menu .....</b>	<b>62</b>
Welcome Screen.....	62
Time Zone and Date .....	63
Monitor Settings.....	65
Print Date (Imprinting Date and Time) .....	67
Photo VR .....	68
Motion Detection.....	69
AF Assist .....	69
Digital Zoom.....	70
Sound Settings .....	70
Action Control Response .....	71
Playback Action Control .....	71
Map actions .....	72
Auto Off .....	72
Format Memory/Format Card.....	73
Language .....	74
TV Settings.....	74
Charge by Computer.....	75
Blink Warning.....	76
Eye-Fi Upload.....	77
Reset All.....	78
Firmware Version .....	78
<b>The Location Data Options Menu.....</b>	<b>79</b>
Location data Options .....	79
Distance Units .....	80
Calculate Distance.....	81

Points of Interest (POI) (Recording and Displaying Location Name Information).....	 82
Create Log (Record the Log of Movement Information) .....	 83
View Log .....	 86
Set Clock from Satellite.....	 88
Electronic Compass .....	 89
Altitude/Depth Options.....	 91
<b>The Wi-Fi Options Menu.....</b>	 92
<b>Error Messages.....</b>	 94
<b>File Names .....</b>	 99
<b>Optional Accessories .....</b>	 101

---















---

## Technical Notes and Index..... 1

---



---

<b>Caring for the Product .....</b>	 2
The Camera.....	 2
The Battery .....	 4
Charging AC Adapter .....	 5
Memory Cards.....	 6
<b>Cleaning and Storage.....</b>	 7
Cleaning.....	 7
Storage .....	 8
<b>Troubleshooting .....</b>	 9
<b>USER LICENSE AGREEMENT FOR MAP DATA AND LOCATION NAME</b>	
<b>DATA.....</b>	 20
<b>Specifications .....</b>	 26
Approved Memory Cards.....	 31
<b>Index.....</b>	 34

Refer to the *Reference Manual* for pages indicated with .

# Parts of the Camera

## The Camera Body

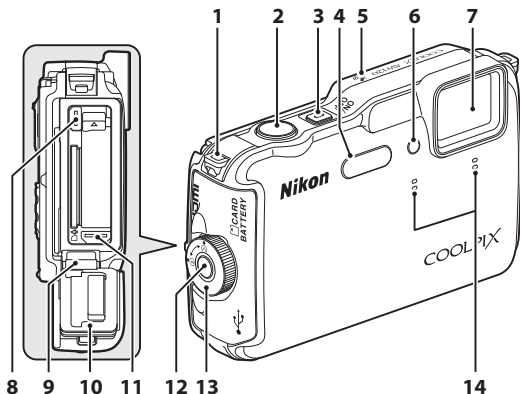

<b>1</b>	Eyelet for camera strap.....	3
<b>2</b>	Shutter-release button.....	28
<b>3</b>	Power switch/power-on lamp.....	22
<b>4</b>	Flash.....	48
<b>5</b>	Positioning antenna.....	78
	Self-timer lamp.....	50
<b>6</b>	AF-assist illuminator.....	76
	Movie light.....	73
<b>7</b>	Lens	

<b>8</b>	HDMI micro connector (Type D).....	92
<b>9</b>	Hinge.....	xiii
<b>10</b>	Waterproofing packing.....	xiii
<b>11</b>	Micro-USB connector.....	92
<b>12</b>	Battery-chamber/memory card slot cover latch release.....	12, 16
<b>13</b>	Battery-chamber/memory card slot cover latch.....	12, 16
<b>14</b>	Microphone (stereo).....	67, 69

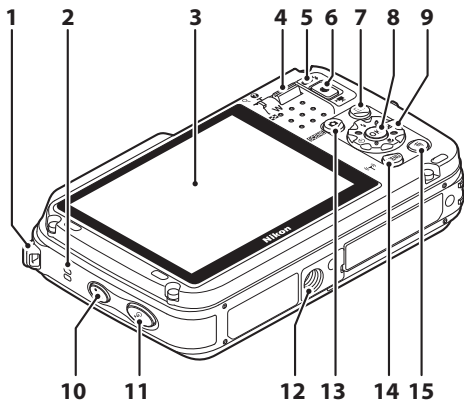

<b>1</b>	Eyelet for camera strap.....	3	<b>8</b>	(apply selection) button.....	6
<b>2</b>	Speaker .....	67, 74, 76	<b>9</b>	Multi selector .....	6
<b>3</b>	OLED monitor (monitor)* .....	8, 22	<b>10</b>	(map) button .....	82
<b>4</b>	Zoom control .....	27	<b>11</b>	(action) button.....	4
	<b>W</b> : wide-angle.....	27	<b>12</b>	Tripod socket	
	<b>T</b> : telephoto .....	27	<b>13</b>	(shooting mode) button.....	24
	: thumbnail playback .....	66	<b>14</b>	<b>MENU</b> (menu) button	
	: playback zoom .....	65		.....	6, 55, 67, 73, 76, 87
	: help .....	35	<b>15</b>	(delete) button .....	31, 75
<b>5</b>	Flash lamp.....	48			
<b>6</b>	(movie-record) button				
	.....	69			
<b>7</b>	(playback) button.....	30			

\* Also referred to as the "monitor" in this manual.

## Attaching the Camera Strap for Land Use

Remove the strap for land use before using the camera underwater.

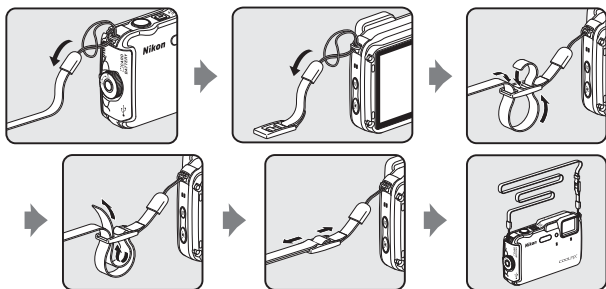

## Using the (Action) Button (Action Control)

When the  (action) button is pressed, you can perform the function by shaking the camera.



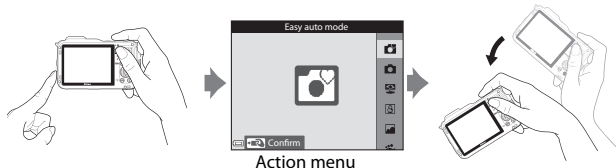

As shown in the illustration, use your wrist and shake the camera for a single up/down or forward/backward stroke to perform the functions.



In the action menu, you can select the following options by shaking the camera up/down or forward/backward.

Press the  (action) button to select the function.

- **Shooting mode:** You can select the **Easy auto mode, Auto mode, Beach, Snow, Landscape** and **Underwater** modes.
- **Start movie recording:** Press the  (action) button to begin recording. Press the button again to exit recording.
- **Quick playback:** Display images in full-frame playback mode.
- **Current position:** Display the current position on a map (only when the location data has been obtained (78)).

## Notes About Playback Action Control

When **Playback action control** in the setup menu (📖76) is set to **On**, you can shake the camera up/down to display the next image or forward/backward to display the previous image in full-frame playback mode.

### Action Control

The following operations can be performed while the map is displayed.

- You can scroll the map when you tilt the camera while pressing the  (action) button.
- You can zoom in the map by shaking the camera once, and zoom out by shaking it twice when **Map actions** in setup menu (📖76) is set to **On**.

### Notes About Action Control

- When using the action control, make sure to hold the camera firmly by passing your hand through the camera strap.
- In the action control, only the  (action) button, shutter-release button and power switch can be used.
- Action control may not perform well depending on how the camera is shaken. Change the Action control response (📖77).

# Using Menus (the MENU Button)

Use the multi selector and **OK** button to navigate the menus.

## 1 Press the **MENU** button.

- The menu is displayed.

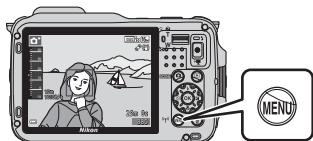

## 2 Press the multi selector **◀**.

- The current menu icon is displayed in yellow.

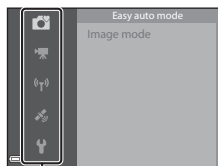

Menu icons

## 3 Select the desired menu icon.

- The menu is changed.

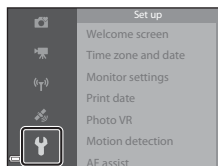

## 4 Press the **OK** button.

- The menu options become selectable.

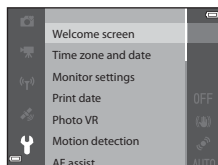

## 5 Select a menu option.

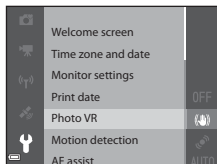

## 6 Press the **OK** button.

- The settings for the option you selected are displayed.



## 7 Select a setting.



## 8 Press the **OK** button.

- The setting you selected is applied.
- When you are finished using the menu, press the **MENU** button.



### Notes About Setting Menu Options

- Certain menu options cannot be set depending on the current shooting mode or the state of the camera. Unavailable options are displayed in gray and cannot be selected.
- When a menu is displayed, you can switch to shooting mode by pressing the shutter-release button or  (movie-record) button.





# The Monitor

The information that is displayed in the monitor during shooting and playback changes depending on the camera's settings and state of use.

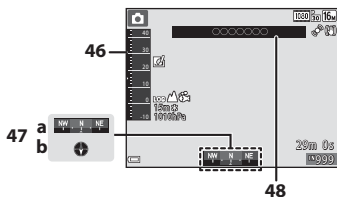
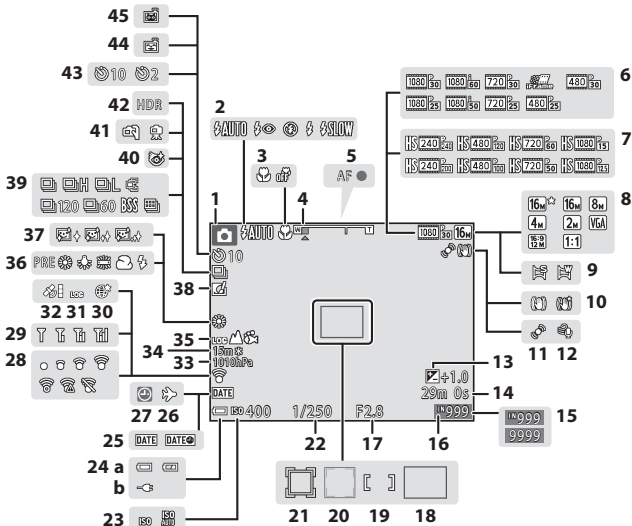
By default, information is displayed when the camera is first turned on and when you operate the camera, and turns off after a few seconds (when **Photo info** is set to **Auto info** in **Monitor settings** (📖76)).

## Shooting Mode



<b>1</b>	Shooting mode.....	24, 25	<b>25</b>	Print date .....	76
<b>2</b>	Flash mode.....	48	<b>26</b>	Travel destination icon..... 	64
<b>3</b>	Macro mode.....	51	<b>27</b>	"Date not set" indicator.....	18
<b>4</b>	Zoom indicator.....	27, 51	<b>28</b>	Eye-Fi communication indicator.....	77
<b>5</b>	Focus indicator.....	28	<b>29</b>	Wi-Fi communication indicator.....	89
<b>6</b>	Movie options (normal speed movies)..... 	73, 54	<b>30</b>	Save location.....	82
<b>7</b>	Movie options (HS movies)..... 	73, 55	<b>31</b>	Log display (Location data).....	83, 88
<b>8</b>	Image mode..... 	56, 30	<b>32</b>	Location data reception.....	80
<b>9</b>	Easy panorama.....	39	<b>33</b>	Atmospheric pressure .....	86
<b>10</b>	Vibration reduction icon.....	73, 76	<b>34</b>	Altitude/water depth.....	86
<b>11</b>	Motion detection icon .....	76	<b>35</b>	Log display (altitude/water depth).....	83, 88
<b>12</b>	Wind noise reduction .....	73	<b>36</b>	White balance mode.....	56
<b>13</b>	Exposure compensation value.....	52	<b>37</b>	Skin softening.....	57
<b>14</b>	Movie recording time remaining.....	69	<b>38</b>	Quick effects icon.....	46, 56
<b>15</b>	Number of exposures remaining (still images).....	22	<b>39</b>	Continuous shooting mode.....	56
<b>16</b>	Internal memory indicator.....	22	<b>40</b>	Blink proof icon.....	57
<b>17</b>	Aperture value.....	29	<b>41</b>	Hand-held/tripod.....	36, 37
<b>18</b>	Focus area (target finding AF).....	56, 61	<b>42</b>	Backlighting (HDR).....	38
<b>19</b>	Focus area (for manual or center).....	56, 64	<b>43</b>	Self-timer indicator.....	50
<b>20</b>	Focus area (face detection, pet detection).....	40, 44, 56, 62	<b>44</b>	Smile timer .....	57
<b>21</b>	Focus area (subject tracking)..... 	56, 40	<b>45</b>	Pet portrait auto release.....	40
<b>22</b>	Shutter speed .....	29	<b>46</b>	Altimeter/depth gauge .....	86
<b>23</b>	ISO sensitivity .....	56	<b>47</b>	Compass display .....	88
<b>24</b>	(a) Battery level indicator.....	22		(a) Direction gauge	
	(b) Charging AC adapter connection indicator		<b>48</b>	Location name information (POI information).....	88
				(b) Compass	

# Playback Mode

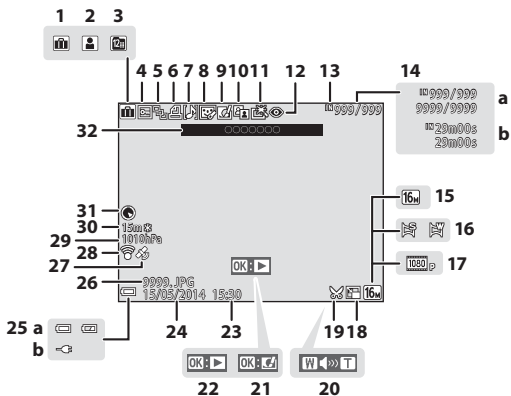

1	Album icon in favorite pictures mode.....	5
2	Category icon in auto sort mode.....	9
3	List by date icon.....	10
4	Protect icon.....	67, 49
5	Sequence display (when <b>Individual pictures</b> is selected).....	68, 53
6	Print order icon.....	67, 45
7	Voice memo indicator....	67, 51
8	Glamour retouch icon....	67, 17
9	Quick effects icon.....	30, 46, 14
10	D-Lighting icon.....	67, 15
11	Quick retouch icon.....	67, 15
12	Red-eye correction.....	67, 16
13	Internal memory indicator.....	22
14	(a) Current image number/ total number of images (b) Movie length	
15	Image mode.....	56, 30
16	Easy panorama.....	39
17	Movie options.....	73, 54
18	Small picture icon.....	67, 19
19	Crop icon.....	65, 20
20	Volume indicator.....	74, 51
21	Quick effects guide.....	30
22	Easy panorama playback guide.....	39, 4
22	Sequence playback guide.....	68, 11
	Movie playback guide.....	74
23	Time of recording	
24	Date of recording	
	(a) Battery level indicator.....	22
25	(b) Charging AC adapter connection indicator	
26	File number and type.....	99
27	Recorded location data indicator.....	80
28	Eye-Fi communication indicator.....	77, 77
29	Atmospheric pressure.....	86
30	Altitude/water depth.....	86
31	Compass display (compass).....	88
32	Location name information (POI information).....	88

# The Basics of Shooting and Playback

## Preparation 1 Insert the Battery

- 1 Press the battery-chamber/memory card slot cover latch release (①) and rotate the battery-chamber/memory card slot cover latch (②) to open the cover (③).

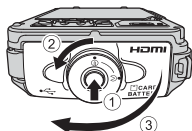

- 2 Insert the battery.

- Push the orange battery latch in the direction indicated by the arrow (①), and fully insert the battery (②).
- The battery locks into place when inserted correctly.

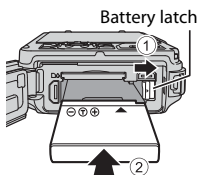

- ✓ Be Careful to Insert the Battery in Correct Direction**

*Inserting the battery upside down or backwards could damage the camera.*



- 3 Push the battery-chamber/memory card slot cover to the camera (①) and rotate the battery-chamber/memory card slot cover latch until the cover is locked (②).

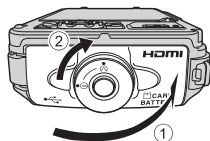

- Rotate the battery-chamber/memory card slot cover latch until it clicks into place.

## ✓ Notes About Closing the Cover without Getting the Camera Strap or Cord Caught

If the camera strap's cord gets caught in the battery-chamber/memory card slot cover when it is closed, the cover could be damaged. Before closing the battery-chamber/memory card slot cover, make sure that the strap or cord does not get caught in it.

## Removing the Battery

Turn the camera off and make sure that the power-on lamp and the monitor have turned off, and then open the battery-chamber/memory card slot cover.

Move the battery latch in the direction indicated by the arrow (1) to eject the battery (2).

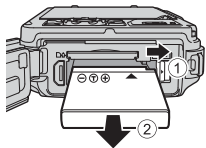

## ✓ High Temperature Caution

The camera, battery, and memory card may be hot immediately after using the camera.

## ✓ Opening/Closing the Battery-Chamber/Memory Card Slot Cover

Do not open and close the battery-chamber/memory card slot cover in a sandy or dusty environment or with wet hands. If the cover is closed without removing foreign particles, water may seep inside the camera or the camera may become damaged.

- If foreign particles get inside the cover or camera, immediately remove them with a blower or brush.
- If liquid such as water gets inside the cover or camera, immediately wipe it off with a soft and dry cloth.

## Preparation 2 Charge the Battery

### 1 Prepare the included charging AC adapter.

If a plug adapter\* is included with your camera, attach the plug adapter to the plug on the charging AC adapter. Push the plug adapter firmly until it is securely held in place. Once the two are connected, attempting to forcibly remove the plug adapter could damage the product.

\* The shape of the plug adapter varies according to the country or region in which the camera was purchased.

This step can be omitted if the plug adapter comes permanently bonded to the charging AC adapter.

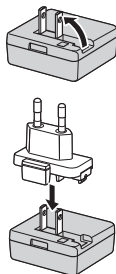

### 2 Make sure the battery is installed in the camera, and then connect the camera to the charging AC adapter in order of ① to ③.

- Keep the camera turned off.
- Make sure that the plugs are properly oriented. Do not insert or remove the plugs at an angle when connecting or disconnecting them.

#### ✓ Notes

Do not use a USB cable other than the UC-E21. Using a USB cable other than the UC-E21 could result in overheating, fire or electric shock.

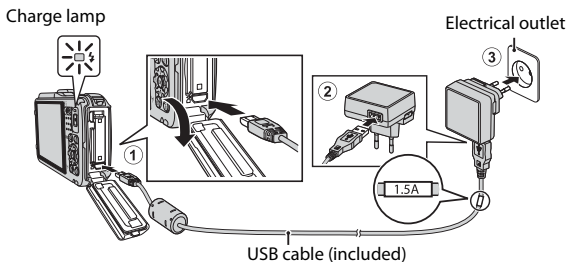

- The charge lamp slowly flashes green to indicate that the battery is charging.



Charge lamp	Description
Flashes slowly (green)	The battery is charging.
Off	When charging is complete, the charge lamp stops flashing green and turns off. About 2 hours and 20 minutes are required to charge a fully exhausted battery.
Flashes quickly (green)	<ul style="list-style-type: none"> <li>The ambient temperature is not suited to charging. Charge the battery indoors with an ambient temperature of 5°C to 35°C (41°F to 95°F).</li> <li>The USB cable or charging AC adapter is not properly connected, or there is a problem with the battery. Disconnect the USB cable or unplug the charging AC adapter and correctly connect it again, or change the battery.</li> </ul>

### 3 Disconnect the charging AC adapter from the electrical outlet and then disconnect the USB cable.

#### Notes About Charging

Do not, under any circumstances, use another make or model of AC adapter other than Charging AC Adapter EH-71P, and do not use a commercially available USB-AC adapter or a battery charger for a mobile phone. Failure to observe this precaution could result in overheating or in damage to the camera.

#### Charging Using a Computer or Battery Charger

- You can also charge the battery by connecting the camera to a computer ( 92,  75).
- You can use the Battery Charger MH-65 (available separately;  101) to charge the battery without using the camera.

## Preparation 3 Insert a Memory Card

- 1 Turn off the camera and open the battery-chamber/memory card slot cover.

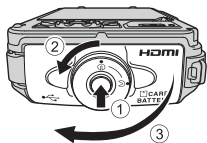

- 2 Insert the memory card.

- Slide the memory card in until it clicks into place.

Memory card slot

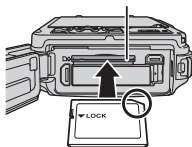

- Be Careful to Insert the Memory Card in Correct Direction**

*Inserting the memory card upside down or backwards could damage the camera and the memory card.*



- 3 Close the battery-chamber/memory card slot cover.

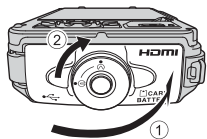

## ✓ Notes About Closing the Cover without Getting the Camera Strap or Cord Caught

If the camera strap's cord gets caught in the battery-chamber/memory card slot cover when it is closed, the cover could be damaged. Before closing the battery-chamber/memory card slot cover, make sure that the strap or cord does not get caught in it.

## ✓ Formatting Memory Cards

The first time you insert a memory card that has been used in another device into this camera, make sure to format it with this camera. Insert the card into the camera, press the **MENU** button, and select **Format card** in the setup menu.

## Removing Memory Cards

Turn the camera off and make sure that the power-on lamp and the monitor have turned off, and then open the battery-chamber/memory card slot cover.

Gently push the memory card into the camera (①) to partially eject the card (②).

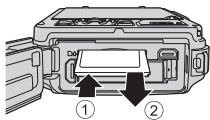

## ✓ High Temperature Caution

The camera, battery, and memory card may be hot immediately after using the camera.

## Internal Memory and Memory Cards

Camera data, including images and movies, can be saved either in the camera's internal memory or on a memory card. To use the camera's internal memory, first remove the memory card.



## Preparation 4 Setting the Display Language, Date, and Time

When the camera is turned on for the first time, the language-selection screen and the date and time setting screen for the camera clock are displayed.

- If you exit without setting the date and time,  will flash when the shooting screen is displayed.

- 1** Press the power switch to turn on the camera.



- 2** Use the multi selector   to select the desired language and press the  button.

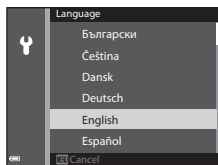

- 3** Select **Yes** and press the  button.

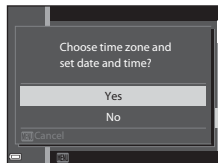

#### 4 Select your home time zone and press the **OK** button.

- To enable daylight saving time, press ▲. When the daylight saving time function is enabled, ☀ is displayed above the map.

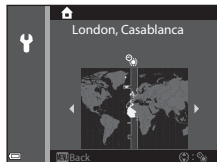

To turn off the daylight saving time function, press ▼.

#### 5 Select the date format and press the **OK** button.

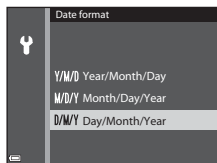

#### 6 Set the date and time, and press the **OK** button.

- Select a field: Press ◀▶ (changes between **D**, **M**, **Y**, **h**, and **m**).
- Edit the date and time: Press ▲▼.
- Confirm the setting: Select the **m** field and press the **OK** button.

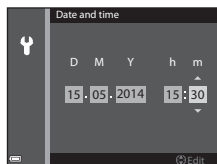

#### 7 Select **Yes** and press the **OK** button.

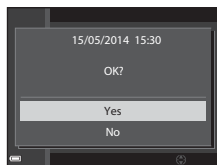

## 8 Read the message about the waterproof function, and press ►.

- There are 6 message screens.

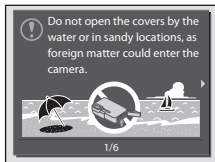

## 9 When you have read the message shown on the right, press the **OK** button.

- The camera switches to shooting mode (📖22).

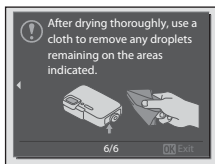

### **Changing the Language Setting and the Date and Time Setting**

- You can change these settings using the **Language** and **Time zone and date** settings in the **Y** setup menu (📖76).
- You can enable or disable daylight saving time in the **Y** setup menu by selecting **Time zone and date** followed by **Time zone**. Enabling daylight saving time moves the clock forward one hour, and disabling it moves the clock back one hour.

### **The Clock Battery**

- The camera's clock is powered by a built-in backup battery. The backup battery charges when the main battery is inserted into the camera or when the camera is connected to an optional AC adapter, and it can run the clock for several days after about 10 hours of charging.
- If the camera's backup battery becomes exhausted, the date and time setting screen is displayed when the camera is turned on. Set the date and time again. See step 3 (📖18) of "Preparation 4 Setting the Display Language, Date, and Time" for more information.

### **Imprinting the Shooting Date on Printed Images**

- You can permanently imprint the shooting date on images as they are captured by setting **Print date** in the setup menu (📖76).
- If you want the shooting date to be printed without using the **Print date** setting, print using the ViewNX 2 software (📖94).



# Step 1 Turn the Camera On

## 1 Press the power switch.

- The monitor turns on.
- To turn the camera off, press the power switch again.
- Note that the power switch is enabled a few seconds after the battery is inserted. Wait a few seconds before pressing the power switch.

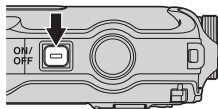

## 2 Check the battery level indicator and the number of exposures remaining.

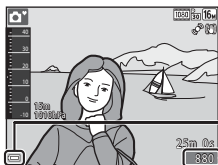

Battery level indicator

Number of exposures remaining

### Battery level indicator

Display	Description
	The battery level is high.
	The battery level is low.
<b>Battery exhausted.</b>	The camera cannot capture images. Recharge the battery.





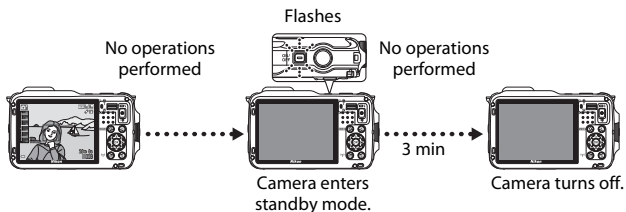

### Number of Exposures Remaining

The number of images that can be taken is displayed.

- **IN** is displayed when no memory card is inserted in the camera, and images are saved in the internal memory.

## The Auto Off Function





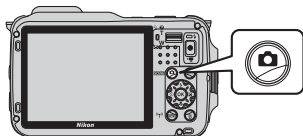

- The time that elapses before the camera enters standby mode is about 1 minute. The time can be changed using the **Auto off** setting in the setup menu (📖76).
- While the camera is in standby mode, the monitor turns back on if you perform any of the following operations:
  - Press the power switch, shutter-release button,  (shooting mode) button,  (playback) button, or  (movie-record) button
- While the charging AC adapter is connected to the camera, the monitor turns back on if you press the power switch. The camera turns off if you press the shutter-release button,  (shooting mode) button,  (playback) button, or  (movie-record) button.

## Step 2 Select a Shooting Mode

- 1 Press the  button.



- 2 Use the multi selector   to select a shooting mode and press the  button.

-  (easy auto) mode is used in this example.
- The selected shooting mode is saved even if the power is turned off.

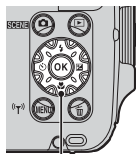

Multi selector

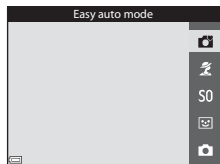

## Available Shooting Modes



### Easy auto mode

33

The camera automatically selects the optimum scene mode when you frame an image, making it even easier to take images using settings that suit the scene.



### Scene mode

35

Camera settings are optimized according to the scene that you select.



### Special effects

42

Effects can be applied to images during shooting.



### Smart portrait

44

The camera detects smiling faces and releases the shutter automatically.



### Auto mode

45

Used for general shooting. Settings can be adjusted to suit the shooting conditions and the type of shot you want to capture.

## Step 3 Frame a Picture

### 1 Hold the camera steady.

- Keep fingers and other objects away from the lens, flash, AF-assist illuminator, microphone, and speaker.
- When taking pictures in portrait (“tall”) orientation, turn the camera so that the flash is above the lens.

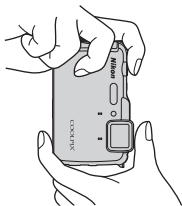
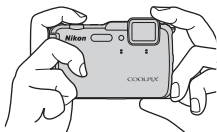

### 2 Frame the picture.

- When the camera automatically determines the scene mode, the shooting mode icon changes (📖33).

Shooting mode icon

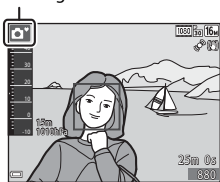

### ✓ Notes About Easy Auto Mode

- Depending upon shooting conditions, the camera may not select the desired scene mode. In this case, select another shooting mode (📖24).
- When the digital zoom is in effect, the scene mode changes to 📷.

## When Using a Tripod

- We recommend using a tripod to stabilize the camera in the following situations.
  - When shooting in dim lighting
  - When shooting with the flash mode (📖49) set to  (off)
  - When using the telephoto setting
- When using a tripod to stabilize the camera during shooting, set **Photo VR** to **Off** in the setup menu (📖76) to prevent potential errors caused by this function.

## Using the Zoom

When you move the zoom control, the zoom lens position changes.

- To zoom in closer to the subject: Move toward **T** (telephoto)
- To zoom out and view a larger area: Move toward **W** (wide-angle)

When you turn the camera on, the zoom moves to the maximum wide-angle position.

- A zoom indicator is displayed at the top of the shooting screen when the zoom control is moved.
- Digital zoom, which allows you to further magnify the subject up to approximately 4x the maximum optical zoom ratio, can be activated by moving and holding the zoom control toward **T** when the camera is zoomed in to the maximum optical zoom position.

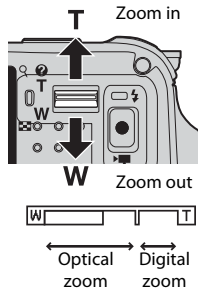

## Notes About Digital Zoom

The zoom indicator turns blue when the digital zoom is activated, and it turns yellow when the zoom magnification is increased further.

- Zoom indicator is blue: Image quality is not noticeably reduced by using the Dynamic Fine Zoom.
- Zoom indicator is yellow: Image quality is noticeably reduced.
- The indicator remains blue across a wider area when the image size is smaller.

## Step 4 Focus and Shoot

### 1 Press the shutter-release button halfway.

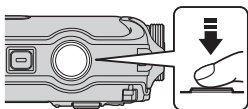

- When the subject is in focus, the focus area that includes the subject or focus indicator (📖9) glows green (multiple focus areas can glow green).
- When you are using digital zoom, the camera focuses on the subject in the center of the frame and the focus area is not displayed. When the camera has focused, the focus indicator (📖9) glows green.
- If the focus area or focus indicator flashes red, the camera is unable to focus. Modify the composition and try pressing the shutter-release button halfway again.



### 2 Without lifting your finger, press the shutter-release button the rest of the way down.



## The Shutter-release Button

<p>Press halfway</p>		<p>To set focus and exposure (shutter speed and aperture value), press the shutter-release button lightly until you feel a slight resistance. Focus and exposure remain locked while the shutter-release button is pressed halfway.</p>
<p>Press all the way</p>		<p>Press the shutter-release button all the way to release the shutter and take an image. Do not use force when pressing the shutter-release button, as this may result in camera shake and blurred images. Press the button gently.</p>

### Notes About Saving Images and Recording Movies

The indicator showing the number of exposures remaining or the indicator showing the maximum movie length flashes while images are being saved or while a movie is being recorded. **Do not open the battery-chamber/memory card slot cover or remove the battery or memory card** while an indicator is flashing. Doing this could result in loss of data, or in damage to the camera or the memory card.



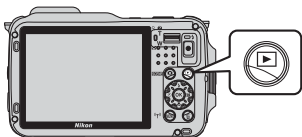

## Step 5 Play Back Images

### 1 Press the (playback) button.

- If you press and hold down the  (playback) button while the camera is turned off, the camera turns on in playback mode.



### 2 Use the multi selector to select an image to display.

- Press and hold down     to scroll through the images quickly.

Display the previous image









Display the next image

- To return to shooting mode, press the  button or shutter-release button.



### Notes About the Quick Effects Function



- When  is displayed in full-frame playback mode, you can press the  button to apply an effect to the image.
  - When the effect selection screen is displayed, use the multi selector   to select an effect, press the  button, and then select **Yes** in the confirmation dialog and press the  button to save the image as a separate file.
- See "Quick Effects: Changing Hue or Mood" ( 14) for more information.



## Step 6 Delete Images

- 1 Press the  button to delete the image currently displayed in the monitor.



- 2 Use the multi selector   to select the desired deletion method and press the  button.

- To exit without deleting, press the **MENU** button.

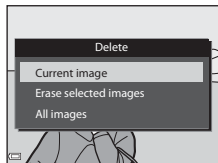

- 3 Select **Yes** and press the  button.

- Deleted images cannot be recovered.
- To cancel, select **No** and press the  button.

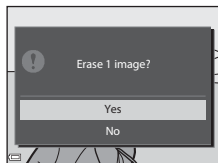

## Operating the Erase Selected Images Screen

**1** Use the multi selector ◀▶ to select an image to be deleted, and then use ▲ to display 🗑️.

- To undo the selection, press ▼ to remove 🗑️.
- Move the zoom control (📖2) toward T (🔍) to switch to full-frame playback or W (🖼️) to switch to thumbnail playback.



**2** Add 🗑️ to all images that you want to delete and then press the OK button to confirm the selection.

- A confirmation dialog is displayed. Follow the instructions displayed in the monitor.

### ✓ Deleting Images in a Sequence

- If you press the 🗑️ button and delete a key picture while only key pictures are displayed for sequences of images (📖68), all images in the sequence, including the key picture, are deleted.
- To delete individual images in a sequence, press the OK button to display them one at a time and press the 🗑️ button.

### 📎 Deleting the Last Image Captured While in Shooting Mode

When using shooting mode, press the 🗑️ button to delete the last image that was saved.

# Shooting Features

## (Easy Auto) Mode

The camera automatically selects the optimum scene mode when you frame a picture, making it even easier to take pictures using settings that suit the scene.

Display the shooting screen →  (shooting mode) button →  (easy auto) mode →  button

When the camera selects a scene mode, the shooting mode icon displayed on the shooting screen changes to that for the scene mode currently enabled.

 Portrait	 Close-up
 Landscape	 Backlighting
 Night portrait	 Underwater*
 Night landscape	 Other scenes

\* The camera is switched to underwater mode when it is lowered into water. When the camera detects it is underwater while **Record location data** in **Location data options** is set to **On** and positioning has been performed, the screen to choose whether to record location data on the image that is shot underwater is displayed. When you select **Yes** or **No** and press the  button, the shooting screen is displayed.

- The focus area depends on the composition of the image. When the camera detects a human face, it focuses on that face ( 62).



### **Note after Taking the Camera out of the Water**

After taking the camera out of water, sometimes it may not automatically switch to another scene from underwater mode.





Gently brush any water droplets with your hand from the camera or wipe it off with a soft and dry cloth. See “Cleaning after Using the Camera Underwater” (📖xv) for more information on caring for the camera.

### **Functions That Can Be Set Using 📷 (Easy Auto) Mode**



















- Flash mode (📖48)
- Self-timer (📖50)
- Exposure compensation (📖52)
- The Shooting menu (📖55)

## Scene Mode (Shooting Suited to Scenes)

When a scene is selected, camera settings are automatically optimized for the selected scene.

Display the shooting screen →  (shooting mode) button →  (the second icon from the top\*) →  →  → select a scene →  button

\* The icon of the last scene selected is displayed.

 Portrait (default setting)	 Close-up (📖37)
 Landscape <sup>1</sup>	 Food (📖37)
 Sports (📖36) <sup>2</sup>	 Museum (📖38) <sup>2</sup>
 Night portrait (📖36)	 Fireworks show (📖38) <sup>1, 3</sup>
 Party/indoor (📖36) <sup>2</sup>	 Black and white copy (📖38) <sup>2</sup>
 Beach <sup>2</sup>	 Backlighting (📖38) <sup>2</sup>
 Snow <sup>2</sup>	 Easy panorama (📖39)
 Sunset <sup>2, 3</sup>	 Pet portrait (📖40)
 Dusk/dawn <sup>1, 3</sup>	 Underwater (📖41) <sup>2</sup>
 Night landscape (📖37) <sup>1</sup>	

<sup>1</sup> The camera focuses at infinity.

<sup>2</sup> The camera focuses on the area in the center of the frame.

<sup>3</sup> Use of a tripod is recommended because the shutter speed is slow. Set **Photo VR** to **Off** in the setup menu (📖76) when using a tripod to stabilize the camera during shooting.

### To View a Description (Help Display) of Each Scene



Select a scene and move the zoom control (📖2) toward **T** (🔍) to view a description of that scene. To return to the original screen, move the zoom control toward **T** (🔍) again.

## Tips and Notes

### Sports

- While the shutter-release button is held all the way down, the camera shoots up to about 5 images continuously at a rate of about 6.9 fps (when image mode is set to **16M 4608×3456**).
- The frame rate for continuous shooting may become slow depending upon the current image mode setting, the memory card used, or shooting condition.
- Focus, exposure, and hue are fixed at the values determined with the first image in each series.



### Night portrait

- From the screen displayed after  **Night portrait** is selected, select **Hand-held** or **Tripod**.
- **Hand-held** (default setting):
  - When the  icon at the top left of the monitor glows green, press the shutter-release button all the way to capture a series of images which are combined into a single image and saved.
  - Once the shutter-release button is pressed all the way, hold the camera still until a still image is displayed. After taking an image, do not turn the camera off before the monitor switches to the shooting screen.
  - If the subject moves while the camera is shooting continuously, the image may be distorted, overlapped, or blurred.
- **Tripod**:
  - One image is captured at a slow shutter speed when the shutter-release button is pressed all the way.
  - Vibration reduction is disabled regardless of the **Photo VR** ()76) setting in the setup menu.



### Party/indoor

- To avoid the effects of camera shake, hold the camera steady. Set **Photo VR** to **Off** in the setup menu ()76) when using a tripod to stabilize the camera during shooting.





## Night landscape

- From the screen displayed after  **Night landscape** is selected, select **Hand-held** or **Tripod**.
- **Hand-held** (default setting):
  - When the  icon at the top left of the monitor glows green, press the shutter-release button all the way to capture a series of images which are combined into a single image and saved.
  - Once the shutter-release button is pressed all the way, hold the camera still until a still image is displayed. After taking an image, do not turn the camera off before the monitor switches to the shooting screen.
  - The angle of view (i.e., the area visible in the frame) seen in the saved image is narrower than that seen in the monitor at the time of shooting.
- **Tripod:**
  - One image is captured at a slow shutter speed when the shutter-release button is pressed all the way.
  - Vibration reduction is disabled regardless of the **Photo VR** (📖76) setting in the setup menu.

## Close-up

- Macro mode (📖51) is enabled and the camera automatically zooms to the closest position at which it can focus.
- You can move the focus area. Press the  button, use the multi selector  to move the focus area, and press the  button to apply the setting.

## Food

- Macro mode (📖51) is enabled and the camera automatically zooms to the closest position at which it can focus.
- You can adjust hue by using the multi selector . The hue setting is saved in the camera's memory even after the camera is turned off.
- You can move the focus area. Press the  button, use the multi selector  to move the focus area, and press the  button to apply the setting.

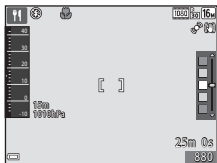

## Museum

- The camera captures a series of up to 10 images while the shutter-release button is held all the way down, and the sharpest image in the series is automatically selected and saved (BSS (Best Shot Selector)).
- The flash does not fire.



## Fireworks show

- The shutter speed is fixed at about 4 seconds.



## Black and white copy

- Use together with macro mode (51) when shooting subjects that are close to the camera.

## Backlighting

- From the screen displayed after  **Backlighting** is selected, select **ON** or **OFF** to enable or disable the high dynamic range (HDR) function based on the type of image you want to take.
- **OFF** (default setting): The flash fires to prevent the subject from being hidden in shadow.
  - When the shutter-release button is pressed all the way down, one image is captured.
- **ON**: Use when taking images with very bright and dark areas in the same frame.
  - When the shutter-release button is pressed all the way, the camera shoots images continuously at high speed, and saves the following two images.
    - A non-HDR composite image
    - An HDR composite image in which the loss of details in highlights or shadows is minimized
  - If there is only enough memory to save one image, an image processed by D-Lighting (67) at the time of shooting, in which dark areas of the image are corrected, is the only image saved.
  - Once the shutter-release button is pressed all the way, hold the camera still until a still image is displayed. After taking an image, do not turn the camera off before the monitor switches to the shooting screen.
  - The angle of view (i.e., the area visible in the frame) seen in the saved image is narrower than that seen in the monitor at the time of shooting.

## Easy panorama

- From the screen displayed after  **Easy panorama** is selected, select the shooting range from **Normal (180°)** or **Wide (360°)**.
- The zoom position is fixed at wide-angle.
- Press the shutter-release button all the way down, remove your finger from the button, and then slowly pan the camera horizontally. Shooting ends when the camera captures the specified shooting range.
- Focus and exposure are locked when shooting starts.
- If you press the  button when a captured image is displayed in full-frame playback mode, the image scrolls automatically.
- You cannot use any image editing functions other than cropping for images captured with easy panorama on this camera.

See “Using Easy Panorama (Shooting and Playback)” ( 2) for more information.



### **Notes About Printing Panorama Images**

The entire image may not be able to be printed depending on the printer's settings. Additionally, printing may not be possible depending on the printer.

## Pet portrait

- When you point the camera at a dog or cat, the camera detects the pet's face and focuses on it. By default, the shutter is automatically released when the camera detects a dog or cat face (pet portrait auto release).
- From the screen displayed after  **Pet portrait** is selected, select **Single** or **Continuous**.
  - **Single**: Whenever the camera detects a dog or cat face, the camera captures 1 image.
  - **Continuous**: Whenever the camera detects a dog or cat face, the camera captures 3 images continuously.

### **Pet Portrait Auto Release**

- Press the multi selector  to change the **Pet portrait auto release** settings.
  - : When the camera detects a dog or cat face, the camera automatically releases the shutter.
  - **OFF**: The camera does not release the shutter automatically, even if a dog or cat face is detected. Press the shutter-release button. The camera also detects human faces when **OFF** is selected.
- **Pet portrait auto release** is set to **OFF** after five bursts have been taken.
- Shooting is also possible by pressing the shutter-release button, regardless of the **Pet portrait auto release** setting.

### **Focus Area**

- When the camera detects a face, the face is displayed inside a yellow border. When the camera acquires focus on a face displayed inside a double border (focus area), the double border turns green. If no faces are detected, the camera focuses on the subject in the center of the frame.
- In some shooting conditions, the pet face may not be detected and other subjects may be displayed inside a border.

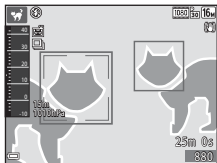

## Underwater







- If you select **Underwater**, screens about recording of location data (📖81) and water depth calibration are displayed followed by messages about waterproofing (refer to the back side of the front cover). The next message is displayed when you press the multi selector ▶ after reading the messages. When the shutter-release button is pressed, the camera switches to shooting mode without displaying any subsequent screens.
- See “<Important> Shockproof, Waterproof, Dustproof, Condensation” (📖xii) for more information on shooting underwater.

## Special Effects Mode (Applying Effects When Shooting)

Effects can be applied to images during shooting.

Display the shooting screen →  (shooting mode) button → S0 (the third icon from the top\*) →  →  →  → Select the effect →  button

\* The last icon you selected is displayed.

Category	Description
S0 Soft (default setting)	Softens the image by adding a slight blur to the entire image.
SE Nostalgic sepia	Adds a sepia tone and reduces the contrast to simulate the qualities of an old photograph.
 High-contrast monochrome	Changes the image to black and white and gives it sharp contrast.
 High key	Gives the entire image a bright tone.
 Low key	Gives the entire image a dark tone.
 Selective color	Creates a black and white image in which only the specified color remains.
POP Pop	Increases the color saturation of the entire image to create a bright look.
VI Super vivid	Increases the color saturation of the entire image and sharpens the contrast.
 Cross process	Gives the image a mysterious appearance based on a specific color.
 Toy camera effect 1	Gives the entire image a yellowish hue and darkens the image periphery.
 Toy camera effect 2	Decreases the color saturation of the entire image and darkens the image periphery.

- The camera focuses on the area in the center of the frame.
- When **Selective color** or **Cross process** is selected, use the multi selector ▲▼ to select the desired color from the slider.

To change settings for any of the following functions, press the **OK** button to end color selection.

- Flash mode (📖48)
- Self-timer (📖50)
- Macro mode (📖51)
- Exposure compensation (📖52)

To return to the color selection screen, press the **OK** button again.

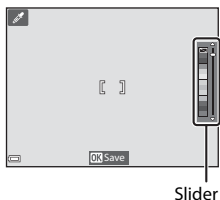

# Smart Portrait Mode (Capturing Images of Smiling Faces)

When the camera detects a smiling face, you can take an image automatically without pressing the shutter-release button (smile timer (📖57)). You can use the skin softening option to smooth the skin tones of human faces.

Display the shooting screen → 📷 (shooting mode) button → 😊 Smart portrait mode → OK button

## 1 Frame the picture.

- Point the camera at a human face.

## 2 Without pressing the shutter-release button, wait for the subject to smile.

- If the camera detects that the face framed by the double border is smiling, the shutter is automatically released.
- Whenever the camera detects a smiling face, it automatically releases the shutter.

## 3 End automatic shooting.

- Perform one of the operations listed below to end shooting.
  - Set **Smile timer** to **Off**.
  - Press the 📷 button and select a different shooting mode.

### ✓ Notes About Smart Portrait Mode

Under some shooting conditions, the camera may be unable to detect faces or detect smiles (📖62). The shutter-release button can also be used for shooting.

### 📌 When the Self-timer Lamp Flashes



When using smile timer, the self-timer lamp flashes when the camera detects a face and flashes quickly immediately after the shutter is released.

## Functions Available in Smart Portrait Mode

- Flash mode (📖48)
- Self-timer (📖50)
- Exposure compensation (📖52)
- Shooting menu (📖55)





## (Auto) Mode

Used for general shooting. Settings can be adjusted to suit the shooting conditions and the type of shot you want to capture.

Display the shooting screen →  (shooting mode) button →  (auto) mode → 

- You can change how the camera selects the area of the frame to focus on by changing the **AF area mode** setting (56).  
The default setting is **Target finding AF** (61).



### Functions Available in (Auto) Mode

- Flash mode (48)
- Self-timer (50)
- Macro mode (51)
- Exposure compensation (52)
- Shooting menu (55)

## Using Quick Effects



When in  (auto) mode, you can apply effects to images immediately after releasing the shutter.



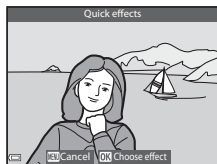

- The edited image is saved as a separate file with a different name.

**1** Press the  button when the image is displayed after it is taken in  (auto) mode.

- When you press the **MENU** button or when no operations are performed for about 5 seconds, the monitor display returns to the shooting screen.
- To not display the screen shown on the right, set **Quick effects** to **Off** in the shooting menu ( 55).



**2** Use the multi selector  to select the desired effect and press the  button.

- Move the zoom control ( 2) toward **T** () to display a confirmation dialog for the applied effect. Move the zoom control toward **W** () to return to the selection screen for effects.
- To exit without saving the edited image, press the **MENU** button. When a confirmation dialog is displayed, select **Yes** and press the  button.
- See “Quick Effects: Changing Hue or Mood” ( 14) for information about the effect types.

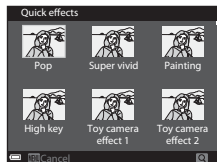

**3** Select **Yes** and press the  button.

## Functions That Can Be Set Using the Multi Selector

The functions that are available vary with the shooting mode, as shown below.

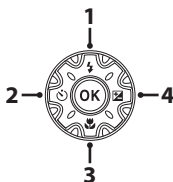

Function	Easy auto	Scene	Special effects	Smart portrait	📷 (auto)
<b>1</b> ⚡ Flash mode (📖48)	✓	*	✓	✓*	✓
<b>2</b> ⌚ Self-timer (📖50)	✓		✓	✓*	✓
<b>3</b> 🌸 Macro mode (📖51)	-		✓	-	✓
<b>4</b> 📷 Exposure compensation (📖52)	✓		✓	✓	✓

\* Availability depends on the setting. See “Default Settings” (📖53) for more information.

## Using the Flash

You can select the flash mode to match the shooting conditions.

- 1 Press the multi selector **▲** (⚡).



- 2 Select the desired flash mode (ⓘ49) and press the **OK** button.

- If a setting is not applied by pressing the **OK** button within a few seconds, the selection will be canceled.

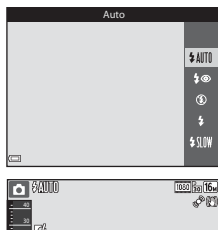

### ✓ The Flash Lamp

- The status of the flash can be confirmed by pressing the shutter-release button halfway.
  - On: The flash fires when you press the shutter-release button all the way down.
  - Flashing: The flash is charging. The camera cannot shoot images.
  - Off: The flash does not fire when an image is taken.
- If the battery level is low, the monitor turns off while the flash is charging.



## Available Flash Modes

### AUTO Auto

The flash fires when necessary, such as in dim lighting.

- The flash mode icon on the shooting screen is displayed only immediately after the setting is made.

### Auto with red-eye reduction

Reduce “red-eye” in portraits caused by the flash.

### Off

The flash does not fire.

- We recommend using a tripod to stabilize the camera when shooting in dark surroundings.

### Fill flash

The flash fires whenever an image is taken. Use to “fill-in” (illuminate) shadows and backlit subjects.

### SLOW Slow sync

Suited to evening and night portraits that include background scenery. The flash fires when necessary to illuminate the main subject; slow shutter speeds are used to capture background at night or under dim lighting.

## The Flash Mode Setting

- The setting may not be available with some shooting modes.
- The setting applied in  (auto) mode is saved in the camera’s memory even after the camera is turned off.

## Auto with Red-eye Reduction

Pre-flashes are fired repeatedly at low intensity before the main flash, reducing the red-eye effect. If the camera detects red-eye while saving an image, the affected area is processed to reduce red-eye before the image is saved.

Note the following when shooting:

- Because pre-flashes are fired, there is a slight lag between when the shutter-release button is pressed and when the image is shot.
- More time than usual is required to save images.
- Red-eye reduction may not produce the desired results in all situations.
- In some rare cases, red-eye reduction may be applied unnecessarily to other areas of the image. In these cases, select another flash mode and take the image again.

## Using the Self-timer

The camera is equipped with a self-timer that releases the shutter about 10 seconds or 2 seconds after you press the shutter-release button. Set **Photo VR** to **Off** in the setup menu (📖76) when using a tripod to stabilize the camera during shooting.

- 1** Press the multi selector ◀ (🕒).



- 2** Select 🕒 **10s** or 🕒 **2s**, and press the **OK** button.

- 🕒 **10s** (10 seconds): Use on important occasions, such as weddings.
- 🕒 **2s** (2 seconds): Use to prevent camera shake.
- If a setting is not applied by pressing the **OK** button within a few seconds, the selection will be canceled.
- When the shooting mode is **Pet portrait** scene mode, 🐾 (pet portrait auto release) is displayed (📖40). The self-timer cannot be used.

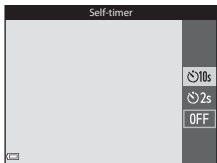

- 3** Frame the picture and press the shutter-release button halfway.

- Focus and exposure are set.

- 4** Press the shutter-release button the rest of the way down.

- Countdown starts. The self-timer lamp flashes and then glows steadily about one second before the shutter is released.
- When the shutter is released, the self-timer is set to **OFF**.
- To stop the countdown, press the shutter-release button again.



# Using Macro Mode

Use macro mode when taking close-up images.

- 1 Press the multi selector ▼ (👉).



- 2 Select ON and press the OK button.

- If a setting is not applied by pressing the OK button within a few seconds, the selection will be canceled.

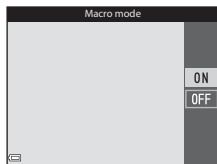

- 3 Move the zoom control to set the zoom ratio to a position where the zoom indicator glows green.



- When the zoom ratio is set to a position where the zoom indicator glows green, the camera can focus on subjects as close as approximately 10 cm (4 in.) from the lens.  
At the wide-angle zoom position from 📷, the camera can focus on subjects as close as approximately 1 cm (0.4 in.) from the lens.

## ✓ Notes About Using the Flash

The flash may be unable to light the entire subject at distances of less than 50 cm (1 ft 8 in.).

## 📌 The Macro Mode Setting

- The setting may not be available with some shooting modes.
- The setting applied in 📷 (auto) mode is saved in the camera's memory even after the camera is turned off.

# Adjusting Brightness (Exposure Compensation)

You can adjust overall image brightness.

- 1 Press the multi selector ► (◻). 



- 2 Select a compensation value and press the **OK** button.

- To brighten the image, set a positive (+) value.
- To darken the image, set a negative (-) value.
- The compensation value is applied, even without pressing the **OK** button.

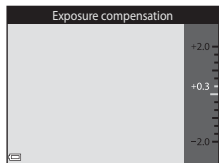























































## Exposure Compensation Value

- The setting applied in  (auto) mode is saved in the camera's memory even after the camera is turned off.
- When the shooting mode is **Fireworks show** (📖38) in scene mode, the exposure compensation cannot be used.
- When the exposure compensation is set while using the flash, the compensation is applied to both the background exposure and to the flash output.

## Default Settings

Default settings for each shooting mode are described below.

Shooting mode	Flash (  48)	Self-timer (  50)	Macro (  51)	Exposure compensation (  52)
 (easy auto)	 AUTO <sup>1</sup>	OFF	OFF <sup>2</sup>	0.0
 (scene)				
 (portrait)		OFF	OFF <sup>3</sup>	0.0
 (landscape)	 <sup>3</sup>	OFF	OFF <sup>3</sup>	0.0
 (sports)	 <sup>3</sup>	OFF <sup>3</sup>	OFF <sup>3</sup>	0.0
 (night portrait)		OFF	OFF <sup>3</sup>	0.0
 (party/indoor)		OFF	OFF <sup>3</sup>	0.0
 (beach)	 AUTO	OFF	OFF <sup>3</sup>	0.0
 (snow)	 AUTO	OFF	OFF <sup>3</sup>	0.0
 (sunset)	 <sup>3</sup>	OFF	OFF <sup>3</sup>	0.0
 (dusk/dawn)	 <sup>3</sup>	OFF	OFF <sup>3</sup>	0.0
 (night landscape)	 <sup>3</sup>	OFF	OFF <sup>3</sup>	0.0
 (close-up)		OFF	ON <sup>3</sup>	0.0
 (food)	 <sup>3</sup>	OFF	ON <sup>3</sup>	0.0
 (museum)	 <sup>3</sup>	OFF	OFF	0.0
 (fireworks show)	 <sup>3</sup>	OFF <sup>3</sup>	OFF <sup>3</sup>	0.0 <sup>3</sup>
 (black and white copy)		OFF	OFF	0.0
 (backlighting)	 <sup>5</sup> /  <sup>5</sup>	OFF	OFF <sup>3</sup>	0.0
 (easy panorama)	 <sup>3</sup>	OFF <sup>3</sup>	OFF <sup>3</sup>	0.0
 (pet portrait)	 <sup>3</sup>	 <sup>6</sup>	OFF	0.0
 (underwater)		OFF	OFF	0.0
 (special effects)		OFF	OFF	0.0
 (smart portrait)	 AUTO <sup>7</sup>	OFF <sup>8</sup>	OFF <sup>3</sup>	0.0
 (auto)	 AUTO	OFF	OFF	0.0

- 1 The camera automatically selects the flash mode appropriate for the scene it has selected.  (off) can be selected manually.
- 2 Cannot be changed. The camera enters macro mode when  is selected.
- 3 The setting cannot be changed.
- 4 May switch to slow sync with red-eye reduction flash mode.
- 5 Flash is fixed at  (fill flash) when **HDR** is set to **OFF**, and is fixed at  (off) when **HDR** is set to **ON**.
- 6 Self-timer cannot be used. Pet portrait auto release can be turned on or off (40).
- 7 Cannot be used when **Blink proof** is set to **On** or when **Smile timer** is set to **On**.
- 8 Can be set when **Smile timer** is set to **Off**.

## Functions That Can Be Set with the MENU Button (Shooting Menu)

The settings listed below can be changed by pressing the **MENU** button during shooting (📖6).

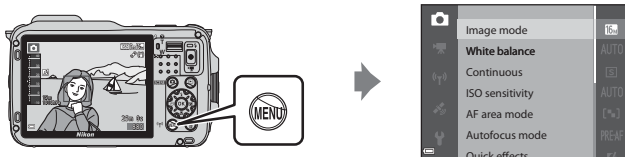













Available functions vary depending on the shooting mode, as shown below.





Function	Easy auto	Scene <sup>2</sup>	Special effects	Smart portrait	📷 (auto)
Image mode <sup>1</sup>	✓	✓	✓	✓	✓
White balance	-	-	-	-	✓
Continuous	-	-	-	-	✓
ISO sensitivity	-	-	-	-	✓
AF area mode	-	-	-	-	✓
Autofocus mode	-	-	-	-	✓
Quick effects	-	-	-	-	✓
Skin softening	-	-	-	✓	-
Smile timer	-	-	-	✓	-
Blink proof	-	-	-	✓	-

<sup>1</sup> The setting is also applied to other shooting modes.

<sup>2</sup> Additional settings are available for some scene modes. See “Tips and Notes” (📖36) for more information.

## Options Available in the Shooting Menu

Option	Description	
Image mode	Allows you to set the combination of image size and image quality used when saving images. • Default setting:  <b>4608x3456</b>	 30
White balance	Allows you to adjust white balance to suit the weather conditions or light source in order to make the colors in images match what you see with your eyes. • Default setting: <b>Auto</b>	 32
Continuous	Allows you to select single or continuous shooting. • Default setting: <b>Single</b>	 34
ISO sensitivity	Allows you to control the camera's sensitivity to light. • Default setting: <b>Auto</b> When <b>Auto</b> is selected,  is displayed in the monitor while shooting if ISO sensitivity increases.	 37
AF area mode	Allows you to determine how the camera selects the focus area that is used for autofocus. • Default setting: <b>Target finding AF</b> (  61)	 38
Autofocus mode	Allows you to set the method how the camera focuses. • Default setting: <b>Pre-focus</b>	 41
Quick effects	Allows you to enable or disable the quick effects function (  46). • Default setting: <b>On</b>	 41

Option	Description	
Skin softening	Allows you to select the skin softening level for human faces. <ul style="list-style-type: none"><li>• Default setting: <b>Normal</b></li></ul>	 42
Smile timer	Allows you to select whether or not the camera automatically releases the shutter when it detects a human smiling face. <ul style="list-style-type: none"><li>• Default setting: <b>On</b></li></ul>	 43
Blink proof	The camera automatically releases the shutter twice with every shot and saves one image in which the subject's eyes are open. <ul style="list-style-type: none"><li>• Default setting: <b>Off</b></li></ul>	 44

## Functions That Cannot Be Used Simultaneously

Some functions cannot be used with other menu options.

Restricted function	Option	Description
Flash mode	Continuous (📖56)	When a setting other than <b>Single</b> is selected, the flash cannot be used.
	Blink proof (📖57)	When <b>Blink proof</b> is set to <b>On</b> , the flash cannot be used.
Self-timer	Smile timer (📖57)	When <b>Smile timer</b> is selected, the self-timer cannot be used.
	AF area mode (📖56)	When <b>Subject tracking</b> is selected, the self-timer cannot be used.
Macro mode	AF area mode (📖56)	When <b>Subject tracking</b> is selected, macro mode cannot be used.
Image mode	Continuous (📖56)	<p><b>Image mode</b> is set as follows depending on the continuous shooting setting:</p> <ul style="list-style-type: none"> <li>• <b>Pre-shooting cache: 1M</b> (image size: 1280 × 960 pixels).</li> <li>• <b>Continuous H: 120 fps: VGA 640×480</b></li> <li>• <b>Continuous H: 60 fps: 1M</b> (image size: 1280 × 960 pixels)</li> <li>• <b>Multi-shot 16: 5M</b> (image size: 2560 × 1920 pixels)</li> </ul>
Continuous	Self-timer (📖50)	If the self-timer is used when <b>Pre-shooting cache</b> is selected, <b>Continuous</b> operates using the <b>Single</b> setting.
ISO sensitivity	Continuous (📖56)	When <b>Pre-shooting cache</b> , <b>Continuous H: 120 fps</b> , <b>Continuous H: 60 fps</b> , or <b>Multi-shot 16</b> is selected, the <b>ISO sensitivity</b> setting is automatically specified according to the brightness.

Restricted function	Option	Description
AF area mode	White balance (📖56)	When a setting other than <b>Auto</b> is selected for <b>White balance in Target finding AF</b> mode, the camera does not detect the main subject.
Quick effects	Continuous (📖56)	The quick effects function cannot be used for images with continuous shooting.
Monitor settings	Quick effects (📖56)	When <b>Quick effects</b> is set to <b>On</b> , images are displayed after shooting regardless of the <b>Image review</b> settings.
Print date	Continuous (📖56)	When <b>Continuous H, Continuous L, Pre-shooting cache, Continuous H: 120 fps, Continuous H: 60 fps</b> or <b>BSS</b> is selected, date and time cannot be imprinted on images.
	Blink proof (📖57)	When <b>Blink proof</b> is set to <b>On</b> , date and time cannot be imprinted on images.
Photo VR	Flash mode (📖48)	If the flash fires when <b>On (hybrid)</b> is selected, <b>Photo VR</b> operates using the <b>On</b> setting.
	Self-timer (📖50)	If the self-timer is used when <b>On (hybrid)</b> is selected, <b>Photo VR</b> operates using the <b>On</b> setting.
	Continuous (📖56)	If Continuous is set to any setting other than <b>Single</b> when <b>On (hybrid)</b> is selected, <b>Photo VR</b> operates using the <b>On</b> setting.
	ISO sensitivity (📖56)	If ISO sensitivity is set to <b>Fixed range auto</b> or ISO 400 or higher when <b>On (hybrid)</b> is selected, <b>Photo VR</b> operates using the <b>On</b> setting.
	Motion detection (📖76)	If Motion detection is set to <b>Auto</b> when <b>On (hybrid)</b> is selected, <b>Photo VR</b> operates using the <b>On</b> setting.

Restricted function	Option	Description
Motion detection	Flash mode (📖48)	When the flash fires, <b>Motion detection</b> is disabled.
	Continuous (📖56)	When <b>Pre-shooting cache</b> , <b>Continuous H: 120 fps</b> , <b>Continuous H: 60 fps</b> or <b>Multi-shot 16</b> is selected, <b>Motion detection</b> is disabled.
	ISO sensitivity (📖56)	When the ISO sensitivity is set to any setting other than <b>Auto</b> , <b>Motion detection</b> is disabled.
Blink warning	Continuous (📖56)	When a setting other than <b>Single</b> is selected, <b>Blink warning</b> is disabled.
Digital zoom	Continuous (📖56)	When <b>Multi-shot 16</b> is selected, digital zoom cannot be used.
	AF area mode (📖56)	When <b>Subject tracking</b> is selected, digital zoom cannot be used.
Shutter sound	Continuous (📖56)	When a setting other than <b>Single</b> is selected, the shutter sound is disabled.

### ✔ Notes About Digital Zoom

- Depending on the shooting mode or the current settings, digital zoom may not be available (📖70).
- When digital zoom is in effect, the camera focuses in the center of the frame.

# Focusing

The focus area varies depending on the shooting mode.

## Using Target Finding AF

When **AF area mode** (📖56) in 📷 (auto) mode is set to **Target finding AF**, the camera focuses in the manner described below.

- When the camera detects the main subject, a yellow border (focus area) is displayed around it. If a human face is detected, the camera automatically sets focus priority on it. When you press the shutter-release button halfway, the focus area that is in focus glows green.

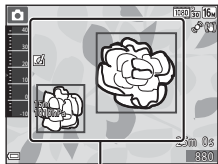

Focus areas

- If no main subject is detected, the camera automatically selects one or more of the 9 focus areas containing the subject closest to the camera when you press the shutter-release button halfway. When the subject is in focus, the focus areas that are in focus glow green.

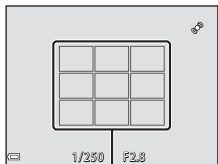



Focus areas

### ✓ Notes About Target Finding AF

- Depending on shooting conditions, the subject that the camera determines to be the main subject may vary.
- The main subject may not be detected when using certain **White balance** settings.
- The camera may not detect the main subject appropriately in the following situations:
  - When the subject is very dark or bright
  - When the main subject lacks clearly defined colors
  - When the shot is framed so that the main subject is at the edge of the monitor
  - When the main subject is composed of a repeating pattern

## Using Face Detection

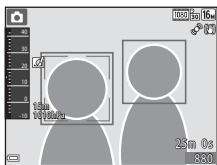

In the following shooting modes, the camera uses face detection to automatically focus on human faces.

-  (easy auto) mode (📖33)
- **Portrait** or **Night portrait** scene mode (📖35)
- Smart portrait mode (📖44)
- When **AF area mode** (📖56) in  (auto) mode (📖45) is set to **Face priority**.



If the camera detects more than one face, a double border is displayed around the face that the camera focuses on, and single borders are displayed around the other faces.

If the shutter-release button is pressed halfway when no faces are detected:

- In  (easy auto) mode, the focus area changes depending on the scene.
- In **Portrait** or **Night portrait** scene mode or smart portrait mode, the camera focuses on the area in the center of the frame.
- In  (auto) mode, the camera selects the focus area containing the subject closest to the camera.

### Notes About Face Detection

- The camera's ability to detect faces depends on a variety of factors, including the direction in which the faces are looking.
- The camera may be unable to detect faces in the following situations:
  - When faces are partially hidden by sunglasses or otherwise obstructed
  - When faces take up too much or too little of the frame

### Face Detection During Movie Recording

When **AF area mode** (📖73) in the movie menu is set to **Face priority**, the camera focuses on human faces during movie recording. If the  (movie-record) button is pressed when no faces are detected, the camera focuses on the area in the center of the frame.

## Using Skin Softening

When the shutter is released while using one of the shooting modes listed below, the camera detects human faces and processes the image to soften facial skin tones (up to 3 faces).

- Smart portrait mode (📖44)
  - The skin softening level can be adjusted.
- 📷 (easy auto) mode (📖33)
- **Portrait** or **Night portrait** scene mode (📖35)

Editing functions such as **Skin softening** can be applied to saved images by using **Glamour retouch** (📖67) even after shooting.

### ✔ Notes About Skin Softening

- It may take more time than usual to save images after shooting.
- Under some shooting conditions, the desired skin softening results may not be achieved, and skin softening may be applied to areas of the image where there are no faces.

## Subjects Not Suitable for Autofocus

The camera may not focus as expected in the following situations. In some rare cases, the subject may not be in focus despite the fact that the focus area or the focus indicator glows green:

- Subject is very dark
- Objects of sharply differing brightness are included in the scene (e.g. the sun behind the subject makes that subject appear very dark)
- No contrast between the subject and surroundings (e.g. a portrait subject wearing a white shirt is standing in front of a white wall)
- Several objects are at different distances from the camera (e.g. the subject is inside a cage)
- Subjects with repeating patterns (window blinds, buildings with multiple rows of similarly shaped windows, etc.)
- Subject is moving rapidly

In the situations noted above, try pressing the shutter-release button halfway to refocus several times, or focus on another subject positioned at the same distance from the camera as the actual desired subject, and use focus lock (📖64).

## Focus Lock

Focus lock shooting is recommended when the camera does not activate the focus area that contains the desired subject.

**1** Set **AF area mode** to **Center** in  (auto) mode ()55).

**2** Position the subject in the center of the frame and press the shutter-release button halfway.

- Confirm that the focus area glows green.
- Focus and exposure are locked.

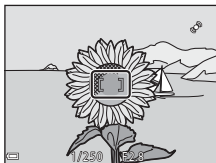

**3** Without lifting your finger, recompose the picture.

- Make sure to maintain the same distance between the camera and the subject.

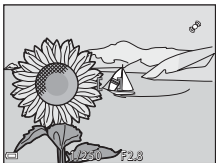

**4** Press the shutter-release button the rest of the way down to take the picture.



# Playback Features

## Playback Zoom

Moving the zoom control toward **T** (Q) in full-frame playback mode (📖30) zooms in on the image.

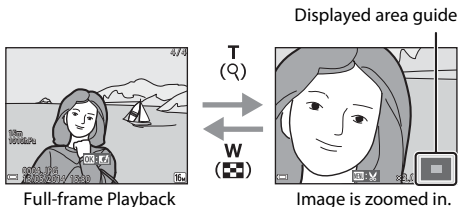

- You can change the zoom ratio by moving the zoom control toward **W** (checkered) or **T** (Q).
- To view a different area of the image, press the multi selector ▲▼◀▶.
- If you are viewing an image that was captured using face detection or pet detection, the camera zooms in on the face detected at the time of shooting (except when viewing an image captured in a series). To zoom in on an area of the image where there are no faces, adjust the zoom ratio and then press ▲▼◀▶.
- When a zoomed image is displayed, press the **OK** button to return to full-frame playback mode.



### Cropping Images

When a zoomed image is displayed, you can press the **MENU** button to crop the image to include only the visible portion and save it as a separate file (📖20).

## Thumbnail Playback, Calendar Display

Moving the zoom control toward **W** (📐) in full-frame playback mode (📖30) displays images as thumbnails.



- You can change the number of thumbnails displayed by moving the zoom control toward **W** (📐) or **T** (📅).
- While using thumbnail playback mode, use the multi selector ▲▼◀▶ to select an image, and then press the **OK** button to display that image full-frame.
- While using calendar display mode, use the multi selector ▲▼◀▶ to select a date, and then press the **OK** button to display the images captured on that day.

### ☑ Calendar Display



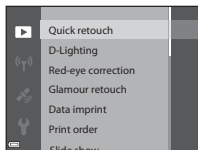
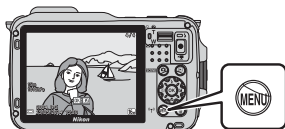

Images captured when the camera's date is not set are treated as images captured on January 1, 2014.

## Functions That Can Be Set with the MENU Button (Playback Menu)

When viewing images in full-frame playback mode or thumbnail playback mode, you can configure the menu operations listed below by pressing the **MENU** button (📖6).



Option	Description	📖
Quick retouch*	Allows you to create retouched copies in which contrast and saturation have been enhanced.	👓15
D-Lighting*	Allows you to create copies with enhanced brightness and contrast, brightening dark portions of an image.	👓15
Red-eye correction*	Corrects “red-eye” that may occur in images when shooting with a flash.	👓16
Glamour retouch*	Detects faces in images and retouches the detected faces glamorously.	👓17
Data imprint*	Print information, such as altimeter or electronic compass information recorded during shooting, on the images.	👓18
Print order	Allows you to select which images are printed, and how many copies of each image are printed, prior to printing.	👓45
Slide show	Allows you to view images in an automatic slide show.	👓48
Protect	Protects selected images from accidental deletion.	👓49
Rotate image	Allows you to rotate the displayed image to portrait or landscape orientation.	👓50
Small picture*	Creates a small copy of images.	👓19
Voice memo	Allows you to use the camera’s microphone to record voice memos and attach them to images.	👓51
Copy	Allows you to copy images between the internal memory and a memory card.	👓52

Option	Description	
Sequence display options	<p>Allows you to select whether to display only the key picture for a sequence of images captured continuously or to display the sequence as individual images.</p> <ul style="list-style-type: none"> <li>When only the key picture is displayed for a sequence, press the <b>OK</b> button to display each image in the sequence. Press the multi selector <b>▲</b> to return to the key picture display.</li> </ul>	 53
Choose key picture	Allows you to change the key picture for images captured in sequence.	 53
Favorite pictures	Allows you to add images to an album. This option is not displayed in favorite pictures mode.	 5
Remove from favorites	Allows you to remove images from an album. This option is displayed only in favorite pictures mode.	 7

\* Edited images are saved as separate files. Some images may not be edited.

# Recording and Playing Back Movies

## Recording Movies

### 1 Display the shooting screen.

- Check the remaining amount of movie recording time.
- If **Photo info** in the **Monitor settings** (📖76) in the setup menu is set to **Movie frame+auto info**, the area that will be visible in the movie can be confirmed before movie recording starts.

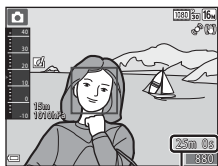

Movie recording time remaining

### 2 Press the **MOVIE** (📽 movie-record) button to start movie recording.

- The focus area for autofocus differs depending on the setting of **AF area mode** (📖73).

The default setting is **Face priority**.

- Press the multi selector **▶** to pause recording, and press **▶** again to resume recording (except when **iFrame 720/30p** (📖74) **iFrame 720/25p**) or an HS movie option is selected in **Movie options**). Recording automatically ends if it remains paused for about five minutes.

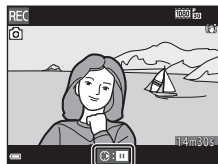
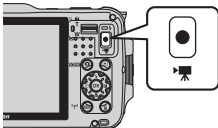

### 3 Press the **MOVIE** (📽 movie-record) button again to end recording.

## ✓ Maximum Movie Length

Individual movie files cannot exceed 4 GB in size or 29 minutes in length, even when there is sufficient free space on the memory card for longer recording.

- The maximum movie length for a single movie is displayed on the shooting screen.
- Recording may end before either limit is reached if camera temperature becomes elevated.
- The actual movie length may vary depending on the movie content, subject movement, or type of memory card.

## ✓ Notes About Saving Images and Recording Movies

The indicator showing the number of exposures remaining or the indicator showing the maximum movie length flashes while images are being saved or while a movie is being recorded. **Do not open the battery-chamber/memory card slot cover or remove the battery or memory card** while an indicator is flashing. Doing this could result in loss of data, or in damage to the camera or the memory card.

## ✓ Notes About Movie Recording

- Memory cards with an SD Speed Class rating of 6 or faster are recommended when recording movies (⚙️:31). Movie recording may stop unexpectedly when memory cards with a lower Speed Class rating are used.
- When using the camera's internal memory, saving movies may take some time.
- Depending on the file size of a movie, it may not be possible to save the movie in the internal memory or copy it from a memory card to the internal memory.
- There may be some degradation in image quality when digital zoom is used.
- The sounds of zoom control operation, zoom, autofocus lens drive movement, vibration reduction, and aperture operation when brightness changes may be recorded.
- The following phenomena may be seen in the monitor while recording movies. These phenomena are saved in the recorded movies.
  - Banding may occur in images under fluorescent, mercury-vapor, or sodium-vapor lighting.
  - Subjects that move quickly from one side of the frame to the other, such as a moving train or car, may appear skewed.
  - The entire movie image may be skewed when the camera is panned.
  - Lighting or other bright areas may leave residual images when the camera is moved.
- Depending on the distance to the subject or the amount of zoom applied, subjects with repeating patterns (fabrics, lattice windows, etc.) may have colored stripes (interference patterns, moire, etc.) in them during movie recording and playback. This occurs when the pattern in the subject and the layout of the image sensor interfere with each other; it is not a malfunction.

## ✓ Notes About Vibration Reduction During Movie Recording

- When **Movie VR** (📖73) in the movie menu is set to **On (hybrid)**, the angle of view (i.e., the area visible in the frame) becomes narrower during movie recording.
- When using a tripod to stabilize the camera during recording, set **Movie VR** to **Off** to prevent potential errors caused by this function.

## ✓ Camera Temperature

- The camera may become warm when shooting movies for an extended period of time or when the camera is used in a hot area.
- If the inside of the camera becomes extremely hot when recording movies, the camera will automatically stop recording.  
The amount of time remaining until the camera stops recording (🕒10s) is displayed.  
After the camera stops recording, it turns itself off.  
Leave the camera off until the inside of the camera has cooled.



## ✓ Notes About Autofocus

Autofocus may not perform as expected (📖63). Should this occur, try the following:

1. Set **AF area mode** to **Center** and **Autofocus mode** to **Single AF** (default setting) in the movie menu before starting movie recording.
2. Frame another subject—positioned at the same distance from the camera as the intended subject—in the center of the frame, press the ● (📷 movie-record) button to start recording, and then modify the composition.





## Saving Still Images While Recording Movies

If the shutter-release button is pressed all the way while recording a movie, one frame is saved as a still image. Movie recording continues while the still image is being saved.

-  is displayed at the top left of the monitor. When  is displayed, a still image cannot be saved.
- The image size of the still images to be saved is the same as the **Movie options** () setting.



### Notes About Saving Still Images During Movie Recording









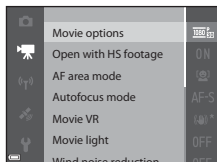

- Still images cannot be saved during movie recording in the following situations.
  - When movie recording is paused
  - When the remaining movie length is less than 5 seconds
  - When **Movie options** is set to  **1080/60i**,  **1080/50i**,  **480/30p**,  **480/25p** or HS movie
- Frames of a movie that were recorded when a still image was being taken may not be played back in a seamless manner.
- The sounds of operating the shutter-release button when saving a still image may be heard in the recorded movie.
- If the camera moves when the shutter-release button is pressed, the image may be blurred.

## Functions That Can Be Set with the MENU Button (Movie Menu)



Enter shooting mode → MENU button →  menu icon →  button

The settings of the menu options listed below can be configured.



Option	Description	
Movie options	Select the movie type. Select normal speed to record movies at normal speed, or HS (high speed) to record movies that play in slow or fast motion. • Default setting:  <b>1080/30p</b> (  <b>1080/25p</b> )	 54
Open with HS footage	Set whether to start recording HS movies or at normal speed when recording HS movies. • Default setting: <b>On</b>	 58
AF area mode	Set the method how the camera selects the focus area for autofocus during movie recording. • Default setting: <b>Face priority</b>	 58
Autofocus mode	Select either <b>Single AF</b> , which locks focus when movie recording begins, or <b>Full-time AF</b> , which continues focusing during movie recording. • Default setting: <b>Single AF</b>	 59
Movie VR	Select the vibration reduction setting used when recording movies. • Default setting: <b>On (hybrid)</b>	 60
Movie light	Set whether or not to enable the movie light that assists recording in dark places during movie recording. • Default setting: <b>Off</b>	 60
Wind noise reduction	Set whether or not to reduce wind noise during movie recording. • Default setting: <b>Off</b>	 61
Frame rate	Select the frame rate used when recording movies.	 61

## Playing Back Movies

Press the  button to enter playback mode.  
Movies are indicated by the movie options icon  (73).

Press the  button to play back movies.

- To adjust the volume, move the zoom control .





Movie options















Volume indicator

## Functions Available During Playback



Playback controls are displayed at the bottom of the monitor.

The operations listed below can be performed by using the multi selector  to select a control and then pressing the  button.



Function	Icon	Description
Rewind		Hold down the  button to rewind the movie.
Advance		Hold down the  button to advance the movie.
Pause		Pause playback. The operations listed below can be performed while paused.
		 Rewind the movie one frame. Hold down the  button for continuous rewinding.
		 Advance the movie one frame. Hold down the  button for continuous advancing.
		 Resume playback.
		 Extract the desired portion of a movie and save it as a separate file.
 Extract a single frame of a movie and save it as a still image.		
End		Return to full-frame playback mode.

## Deleting movies

To delete a movie, select the desired movie in full-frame playback mode (30) or thumbnail playback mode (66) and press the  button (31).









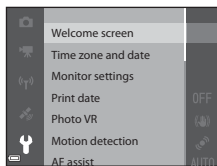

# General Camera Setup













## Functions That Can Be Set with the MENU Button (Setup Menu)

Press the MENU button →  (setup) menu icon →  button

The settings of the menu options listed below can be configured.



Option	Description	
Welcome screen	Allows you to select whether or not the welcome screen is displayed in the monitor when the camera is turned on.	 62
Time zone and date	Allows you to set the camera clock.	 63
Monitor settings	Allows you to adjust photo information display, post-shooting image review, and monitor brightness settings.	 65
Print date	Allows you to imprint the shooting date and time on images.	 67
Photo VR	Allows you to select the vibration reduction setting used when shooting still images.	 68
Motion detection	Allows you to set whether or not the camera automatically increases the shutter speed to reduce blurring caused by camera shake if motion is detected when shooting still images.	 69
AF assist	Allows you to enable or disable the AF-assist illuminator.	 69
Digital zoom	Allows you to enable and disable digital zoom.	 70
Sound settings	Allows you to adjust sound settings.	 70

Option	Description	
<b>Action control response</b>	Allows you to set the sensitivity of the operation performed when shaking the camera (action control).	 71
<b>Playback action control</b>	Allows you to set whether or not to enable the image to be selected by shaking the camera in full-frame playback mode.	 71
<b>Map actions</b>	Allows you to zoom in and out of maps by shaking the camera.	 72
<b>Auto off</b>	Allows you to set the amount of time that passes before the monitor turns off to save power.	 72
<b>Format memory/ Format card</b>	Allows you to format the internal memory or the memory card.	 73
<b>Language</b>	Allows you to change the camera's display language.	 74
<b>TV settings</b>	Allows you to adjust TV-connection settings.	 74
<b>Charge by computer</b>	Allows you to set whether or not the battery in the camera is charged when the camera is connected to a computer.	 75
<b>Blink warning</b>	Allows you to set whether or not closed eyes are detected when taking images of people using face detection.	 76
<b>Eye-Fi upload</b>	Allows you to set whether or not to enable the function for sending images to a computer using a commercially available Eye-Fi card.	 77
<b>Reset all</b>	Allows you to reset the camera's settings to their default values.	 78
<b>Firmware version</b>	View the current camera firmware version.	 78



# Using Location Data Functions/ Displaying Maps

## Starting Location Data Recording



This camera receives signals from positioning satellites and obtain its current time and location data.

The obtained location data (latitude and longitude) can be recorded on the images to be shot.

### Turn the Location Data Functions On

Press the **MENU** button →  (location data options) menu icon → Location data options →  button

Set **Time zone and date** (76) correctly before using the location data functions.

- Use the multi selector   to select **Record location data**, and then press the  button.

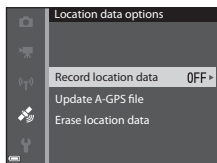

- Select **On** and press the  button.

- Signals are received from the positioning satellites and positioning starts.

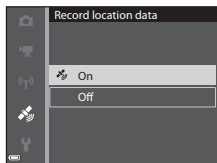

- Press the **MENU** button.

- The camera returns to shooting screen.
- Operate in an open-air area when starting to receive signals from positioning satellites.



## Notes About Location Data Functions

- Before using the location data functions, read "<Important> Notes About Location Data Functions (GPS/GLONASS, Electronic Compass)" (📖xviii).
- It takes a few minutes to obtain location data when positioning is performed for the first time or in a situation where positioning cannot be performed for a long period of time, or just after the battery is replaced.
- Positions of the positioning satellites change constantly.  
You may not be able to determine the position or it may take some time depending on your location and the time.  
To use the location data functions, use the camera in an open-air area with few obstacles in the sky.  
Signal receiving will be smoother if the positioning antenna (📖1) is facing the sky.
- The following locations which block or reflect signals may result in failed or inaccurate positioning.
  - Inside buildings or underground locations
  - Between high-rise buildings
  - Under overpasses
  - Inside tunnels
  - Near high-voltage electrical power lines
  - Between clusters of trees
  - Underwater
- Using a mobile phone of 1.5 GHz band near this camera may disrupt positioning.
- When carrying this camera around while positioning, do not place it in a metal bag. Positioning cannot be performed if the camera is covered with metal materials.
- When there is a significant difference in the signals from the positioning satellites, there could be a deviation of up to several hundred meters.
- Be aware of your surroundings when positioning.
- The shooting date and time that is displayed when playing back images is determined by the camera's internal clock at the time of shooting.  
The time obtained by the location data and recorded on images will not be displayed on the camera.
- The location data for the first frame will be recorded on a series of images shot using continuous shooting.

## ✓ Battery Drain While Recording Location Data and Log Recording

- When **Record location data** is set to **On**, record location data functions will continue to operate at the specified interval for approximately 6 hours even after the camera is turned off. Also, record location data functions and log recording will continue to operate while recording logs (📖88) even after the camera is turned off.
- When **Record location data** is set to **On** or while recording logs, the battery power will drain faster than usual. Confirm the battery level especially when recording a log using **Start all logs** or **Start depth log**.

## 📌 Location Data Reception Indicator and Points of Interest (POI) Information

- Location data reception can be checked on the shooting screen.
  - 📶: Signals are being received from four or more satellites and positioning is being performed. The location data is recorded on the image.
  - 📶: Signals are being received from three satellites and positioning is being performed. The location data is recorded on the image.
  - 📶: Signals are being received from the satellites, but positioning is not possible. The location data is not recorded on the image.
  - 📶: Signals cannot be received from the satellites, and positioning is not possible. The location data is not recorded on the image.
- POI information is location name information for the nearest landmarks (facilities) and other details.
  - When **Display POI in Points of interest (POI)** of the Location data options menu (📖87) is set to **On**, the nearest location name information for the current position is displayed during shooting.
  - When **Embed POI** is set to **On**, location name information can be recorded on the image during shooting.
  - If the location name information was recorded on the image during shooting, this information is displayed when **Display POI** is set to **On** during playback.
- The location name information may not be displayed depending on the setting level in **Level of detail** of **Points of interest (POI)**. Also, certain landmark names may not be registered, or the landmark name may be different.

Location name information (POI information)

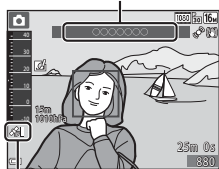

Location data reception



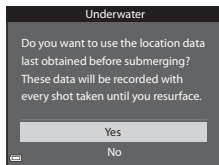

## Underwater Recording of Location Data

While the location data is being obtained, if you select **Underwater** scene mode, or select  (easy auto) mode and then submerge the camera underwater, the screen on the right is displayed.

Select **Yes** and press the  button. The location data obtained prior to underwater shooting is recorded on the images to be shot underwater.



## Images with Recorded Location Data

- The  icon is displayed during playback for images which have the location data recorded (10).
- The location data recorded on an image can be checked on a map with ViewNX 2 after transferring the image to a computer (94).
- The actual place of shooting may differ from the location data recorded on the image files due to the accuracy of the location data obtained and a difference in the geodetic system used.
- The location data and POI information recorded on images can be erased using **Erase location data** in **Location data options** (87). The erased information cannot be recovered.

## Displaying Maps

The current position or image shooting location can be displayed on the screen using the camera's internal map information.



To display the map, press the  (map) button in shooting mode or playback mode.

- Maps cannot be displayed while the camera is being charged with the charging AC adapter.



## When Using Shooting Mode

To display the current position on the screen, press the  (map) button in shooting mode when **Record location data** in **Location data options** of the Location data options menu is set to **On**.

- To display the current position, the location data must have been obtained.
- To adjust the scale of the map, use the zoom control (**W** /**T** ).

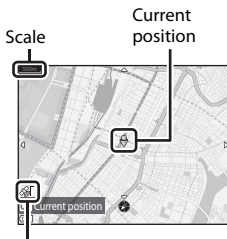

Location data reception

- To move the map display, use the multi selector.
- The following operations can be performed when you press the **OK** button.
  - **Center on current location:** Display the current position at the center of the map.
  - **Save location:** Select a location on the map and save it by pressing the **OK** button.
  - **Center on saved location:** Move the map by selecting a location you have saved (85). You can cancel a location you have saved.
- When the camera lens faces downward, a compass is displayed. A compass is displayed even if **Compass display** in the location data options is set to **Off**.



## ✓ Map Display

- The map display cannot be rotated. Only the north up display (the top of the screen indicates the north) is available.
- The map display scale varies depending on which country is shown on the map.
- In shooting mode, when **Record location data** in **Location data options** of the Location data options menu is set to **Off** or when positioning could not be performed, a world map centered on the region that was set in **Time zone** of **Time zone and date** in the setup menu (📖76) or a map displayed just before the current screen is displayed.

## 📎 Notes About Direction and Location Data Display



Direction or location data, etc. is displayed when a map is being displayed in shooting mode or if the 🌐 (map) button is held down while the power is off.

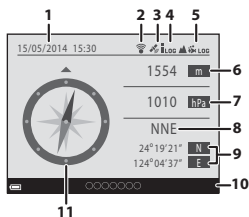

- 1 Date and time
- 2 Eye-Fi communication indicator
- 3 Location data reception
- 4 Create log display (location data)
- 5 Create log display (altitude/water depth)
- 6 Altitude
- 7 Atmospheric pressure
- 8 Direction
- 9 Latitude and longitude
- 10 Location name information (Points of Interest: POI)\*
- 11 Compass display



- \* "----" may be displayed for the location name information depending on the setting level in **Level of detail** of **Points of interest (POI)**.

## When Using Playback Mode

If an image displaying  in the full-frame display is selected and the  (map) button is pressed, the image shooting location is displayed on the screen.

- To display the map and the image shooting location, the location data must have been recorded on playback image.
- To adjust the scale of the map, use the zoom control (**W** /T ).
- To move the map display, use the multi selector.







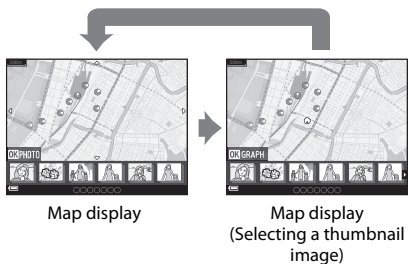

Scale



Location name information ( 80)



- When the  button is pressed, another image can be selected. Only images with the recorded location data are displayed in the thumbnail display.

- The following operations can be performed when you press the **OK** button while thumbnails are displayed.
  - **Scroll map:** Return to the map display screen
  - **Altitude/depth logs:** Display the altitude log or water depth log graph (  88) when you play back images shot while the altitude log or water depth log was recorded using **Create log** (  88).
  - **Save location:** Save the shooting location of the image displayed as a location.
  - **Center on saved location:** Move the map by selecting a location you have saved (  85). You can cancel a location you have saved.
- The image shooting location and a rough direction are indicated by  on the map (  indicates north), and the selected image is highlighted in yellow.
- Press the multi selector   to select the image.
- Operate the zoom control toward **T** (  ) to enlarge the image. Operate the zoom control toward **W** (  ) to return to the map display.

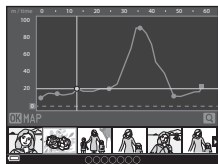

Altitude log or water  
depth log  
Graph display



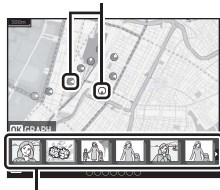

Image shooting location  
and direction



Thumbnail display

## Notes About Saving Locations

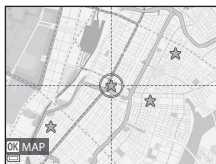

You can save up to 30 locations.

- When you select **Center on saved location**, the map scrolls to the closest saved location from the center of the screen.
- Use the multi selector    to move to other saved locations.
- Press the  button to cancel a location.
- When you press the **OK** button, the monitor display returns to the previous screen.



## Using Altimeter and Depth Gauge

You can display the altitude or water depth and the atmospheric pressure of the current position on the screen and record the displayed value on the images to be shot.

- Use **Alt./depth correction** in the Location data options menu to correct the data in advance. Before using the camera underwater, make sure to adjust the data to 0 m at the surface of water. You can display a more accurate altitude or water depth if you adjust the data frequently. When altitude or water depth is corrected,  is displayed next to the altitude or water depth.
- The altitude or water depth, and the atmospheric pressure are always displayed.
- The altimeter or depth gauge is displayed when the **Altimeter/depth gauge** setting of **Altitude/depth options** in the Location data options menu (87) is set to **On** (default setting).
- The depth gauge and water depth are displayed when you select **Underwater** scene mode, or select  (easy auto) mode and then submerge the camera under water.
- The display range of the altimeter and altitude is -300 m to +4500 m (-984 to +14,760 ft).
- The display range of the depth gauge and water depth is 0 m to 20 m (0 ft to 65 ft).

Altimeter or depth gauge

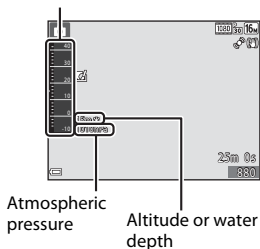

### Notes About Altimeter and Depth Gauge

- Do not use the altimeter or depth gauge in this camera for specialized applications such as mountain climbing or underwater diving. The displayed information is intended as a general guide only.
- Since the altitude is measured using the camera's internal barometer, the data may not be displayed correctly in some climate conditions.
- When **Altimeter/depth gauge** is set to **On**, the altimeter or depth gauge and the atmospheric pressure are displayed even if **Hide info** is selected for **Photo info** in **Monitor settings** of the setup menu (76).
- If the camera is not being used for underwater shooting when **Underwater** scene mode is selected, the depth gauge display is fixed at 0 m (0 ft).
- When the water depth exceeds 15 m (49 ft), the depth gauge display turns orange. When water depth exceeds 18 m (59 ft), the depth gauge display turns red.



## Altitude Log and Water Depth Log

When **Create log** in the Location data options menu is selected, altitude or water depth information can be recorded at regular intervals.



- If you select **Start all logs**, the log recording of location, altitude, and water depth information starts.
- If you select **Start depth log** and submerge the camera under water, only the log recording of water depth starts.

You can display the recorded logs as graphs by using **View log**.

## More Information

See "Data imprint" ( 67,  18) to imprint information such as altitude and direction measured by electronic compass on images.





## Functions That Can Be Set Using the MENU Button (Location Data Options Menu)



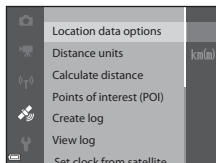



Press the **MENU** button →  (location data options) menu icon → 

The settings of the menu options listed below can be configured.

- The Location data options menu can be displayed also by pressing the **MENU** button while the map is displayed.



Option	Description	
Location data options	Allows you to enable location data functions. To update the A-GPS file, access the website below. <a href="http://nikonimglib.com/agps3/">http://nikonimglib.com/agps3/</a> <ul style="list-style-type: none"><li>• Default setting:<ul style="list-style-type: none"><li>- <b>Record location data: Off</b></li></ul></li></ul>	 79
Distance units	Allows you to set the distance units of the map display. <ul style="list-style-type: none"><li>• Default setting: <b>km (m)</b></li></ul>	 80
Calculate distance	Allows you to calculate the linear distance from the current position to the shooting location of the image or between image shooting locations.	 81

Option	Description	
Points of interest (POI)	<p>Allows you to make the settings for the POI (points of interest, location name information).</p> <ul style="list-style-type: none"> <li>• Default setting:               <ul style="list-style-type: none"> <li>- <b>Embed POI: Off</b></li> <li>- <b>Display POI: Off</b></li> <li>- <b>Level of detail: Level 6 (detailed)</b></li> </ul> </li> </ul>	 82
Create log	<p>Allows you to make the settings to create a log of location, altitude, and water depth information. You can delete the log data or save it to memory card.</p> <ul style="list-style-type: none"> <li>• Default setting:               <ul style="list-style-type: none"> <li>- <b>Start all logs → Log interval: 15 s, Start log: Log data for next 24 hrs</b></li> <li>- <b>Start location log → Log interval: 15 s, Start log: Log data for next 24 hrs</b></li> <li>- <b>Start depth log → Log interval: 1 min</b></li> </ul> </li> </ul>	 83
View log	<p>Allows you to check or erase the log data saved on a memory card.</p>	 86
Set clock from satellite	<p>Allows you to set the date and time of the camera's internal clock using signals from the positioning satellites.</p>	 88
Electronic compass	<p>Allows you to set whether or not to display the electronic compass. You can display the electronic compass and calibrate it if it is not displaying the correct directions.</p> <ul style="list-style-type: none"> <li>• Default setting:               <ul style="list-style-type: none"> <li>- <b>Compass display: Off</b></li> </ul> </li> </ul>	 89
Altitude/depth options	<p>Allows you to set whether to display the altimeter or depth gauge. You can display the altimeter and depth gauge and calibrate them if they are not displaying the correct directions.</p> <ul style="list-style-type: none"> <li>• Default setting:               <ul style="list-style-type: none"> <li>- <b>Altimeter/depth gauge: On</b></li> <li>- <b>Altimeter/depth units: m</b></li> </ul> </li> </ul>	 91

# Using the Wi-Fi (Wireless LAN) Function

## Functions That Can Be Performed Using Wi-Fi

You can perform the following functions if you install the dedicated software “Wireless Mobile Utility” on your smart device that runs on Android OS or iOS, and connect it to the camera.

### Take Photos

You can take still images using the two methods described below.

- Release the shutter on the camera and save the captured images to a smart device.
- Use a smart device to remotely\* release the camera shutter and save images to the smart device.  
\*Operations cannot be performed on the camera during remote control operation.

### View Photos

You can copy the images saved in the camera’s memory card and view them on your smart device.

## Installing the Software on the Smart Device

- 1** Use your smart device to connect to Google Play Store, App Store or other online apps marketplace and search for “Wireless Mobile Utility.”
  - Check the user’s manual provided with your smart device for further details.
- 2** Check the description and other information and install the software.
  - For more information about how to operate the software, download the user’s manual from the website below.
    - Android OS: <http://nikonimglib.com/ManDL/WMAU/>
    - iOS: <http://nikonimglib.com/ManDL/WMAU-ios/>

# Connecting the Smart Device to the Camera

Press the MENU button →  menu icon →  button

## 1 Use the multi selector ▲▼ to select **Connect to smart device** and press the button.

- If **Connect to smart device** cannot be selected, see "Notes About Wi-Fi Connection" (📖91).
- When the Wi-Fi function is turned on, the SSID and password of the camera are displayed.
- If no connection confirmation is received from the smart device within 3 minutes, the message "No access." is displayed and the camera returns to the Wi-Fi options screen.

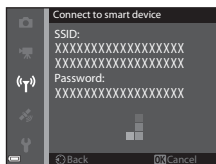
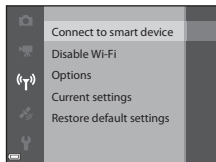

## 2 Set the Wi-Fi setting on the smart device to On.

- Check the user's manual provided with your smart device for further details.
- After the network name (SSID) that can be used for the smart device is displayed, select the SSID displayed on the camera.
- When the message for entering a password is displayed, enter the password that is displayed on the camera.
- When the camera is successfully connected to a Wi-Fi network, the shooting screen is displayed on the camera with the Wi-Fi communication indicator (📖9).

## 3 Start "Wireless Mobile Utility" installed on the smart device.



- The screen for selecting "Take photos" or "View photos" is displayed.
- When the message "Cannot connect to camera." is displayed, return to step 1 and retry the procedure.

## To Terminate the Wi-Fi Connection

Perform one of the following operations.

- Turn off the camera.
- Select **Disable Wi-Fi** in the Wi-Fi options menu on the camera (except when the camera is operated by remote control).
- Set the Wi-Fi setting on the smart device to Off.

### Notes About Wi-Fi Connection

- **Connect to smart device** cannot be selected in the following situations:
  - When no memory card is inserted in the camera.
  - When an Eye-Fi card (🔑77) is inserted in the camera.
  - When the camera is connected to a TV, computer, or printer.
  - When the battery level indicator in the monitor indicates . In addition, if  is indicated when Wi-Fi is connected, the connection is terminated.
- Select **Disable Wi-Fi** in a place where the use of radio waves is prohibited.
- When Wi-Fi is connected, **Auto off** is disabled.
- When Wi-Fi is connected, the battery drains faster than normal.

### Notes About Security Settings

If the camera is installed with the Wi-Fi function without proper security settings (encryption and password), unauthorized third parties may access the network and cause harm. We strongly recommend performing the required security settings before using the Wi-Fi function.

Use **Options** of the Wi-Fi options menu (🔑92) to perform the security settings.

# Connecting the Camera to a TV, Computer, or Printer

## Connection Methods

You can enhance your enjoyment of images and movies by connecting the camera to a TV, computer, or printer.

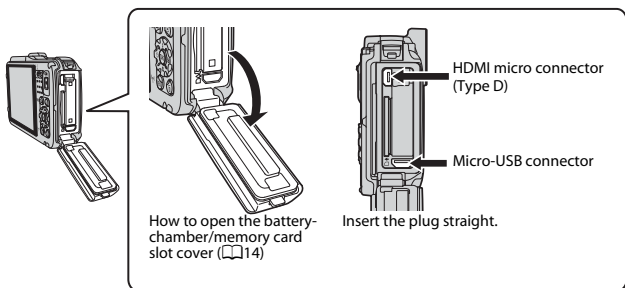

- Before connecting the camera to an external device, make sure the remaining battery level is sufficient and turn the camera off. Before disconnecting, make sure to turn the camera off.
- If the AC Adapter EH-62F (available separately) is used, this camera can be powered from an electrical outlet. Do not use any other make or model of AC adapter as it may cause the camera to heat up or malfunction.
- For information about the connection methods and subsequent operations, refer to the documentation included with the device in addition to this document.



Images and movies captured with the camera can be viewed on a TV.

Connection method: Connect a commercially available HDMI cable to the TV's HDMI input jack.



You can transfer images to a computer to perform simple retouching and manage image data.

Connection method: Connect the camera to the computer's USB port with the USB cable.

- Before connecting to a computer, install ViewNX 2 on the computer ( 94).
- If any USB devices that draw the power from the computer are connected, disconnect them from the computer before you connect the camera to it. Connecting the camera and other USB-powered devices to the same computer simultaneously may cause a camera malfunction or excessive power supply from the computer, which could damage the camera or memory card.



If you connect the camera to a PictBridge-compatible printer, you can print images without using a computer.

Connection method: Connect the camera directly to the printer's USB port with the USB cable.

## Using ViewNX 2

Install ViewNX 2 to upload, view, edit, and share photos and movies.

### Your Imaging Toolbox

ViewNX 2™



### Installing ViewNX 2

An Internet connection is required. For system requirements and other information, see the Nikon website for your region.

---

#### 1 Download the ViewNX 2 installer.

Start the computer and download the installer from:

<http://nikonimglib.com/nvnx/>

---

#### 2 Double-click the downloaded file.

---

#### 3 Follow the on-screen instructions.

---

#### 4 Exit the installer.

Click **Yes** (Windows) or **OK** (Mac).

# Transferring Images to the Computer

## 1 Choose how images will be copied to the computer.

Choose one of the following methods:

- **Direct USB connection:** Turn the camera off and ensure that the memory card is inserted in the camera. Connect the camera to the computer using the USB cable. The camera automatically turns on.  
To transfer images that are saved in the camera's internal memory, remove the memory card from the camera before connecting it to the computer.

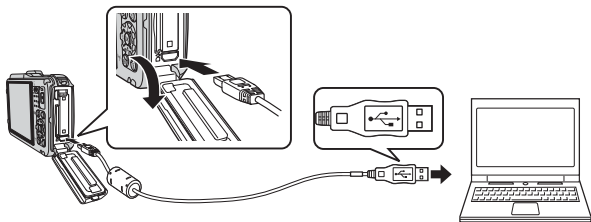

- **SD card slot:** If your computer is equipped with an SD card slot, the card can be inserted directly in the slot.
- **SD card reader:** Connect a card reader (available separately from third-party suppliers) to the computer and insert the memory card.

If a message is displayed prompting you to choose a program, select Nikon Transfer 2.

### • When using Windows 7

If the dialog shown at right is displayed, follow the steps below to select Nikon Transfer 2.

- 1 Under **Import pictures and videos**, click **Change program**. A program selection dialog will be displayed; select **Import File using Nikon Transfer 2** and click **OK**.
- 2 Double-click **Import File**.



If the memory card contains a large number of images, it may take a while for Nikon Transfer 2 to start. Wait until Nikon Transfer 2 starts.

## ✓ Connecting the USB Cable

The connection may not be recognized if the camera is connected to the computer via a USB hub.

---

## 2 Transfer images to the computer.

- Click **Start Transfer**.

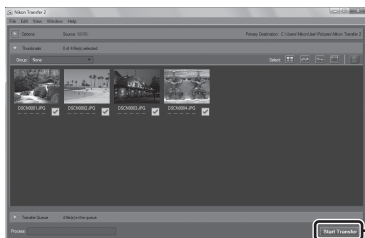

- At default settings, all the images on the memory card will be copied to the computer.

---

## 3 Terminate the connection.

- If the camera is connected to the computer, turn the camera off and disconnect the USB cable.
- If you are using a card reader or card slot, choose the appropriate option in the computer operating system to eject the removable disk corresponding to the memory card and then remove the card from the card reader or card slot.

# Viewing Images

## Start ViewNX 2.

- Images are displayed in ViewNX 2 when transfer is complete.
- Consult online help for more information on using ViewNX 2.

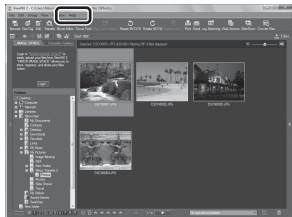

### Starting ViewNX 2 Manually

- **Windows:** Double-click the **ViewNX 2** shortcut on the desktop.
- **Mac:** Click the **ViewNX 2** icon in the Dock.



A series of horizontal dashed lines spanning the width of the page, intended for handwriting practice.



# Technical Notes and Index

<b>Caring for the Product</b> .....	2
The Camera.....	2
The Battery.....	4
Charging AC Adapter.....	5
Memory Cards.....	6
<b>Cleaning and Storage</b> .....	7
Cleaning.....	7
Storage.....	8
<b>Troubleshooting</b> .....	9
<b>USER LICENSE AGREEMENT FOR MAP DATA AND LOCATION NAME DATA</b> .....	20
<b>Specifications</b> .....	26
Approved Memory Cards.....	31
<b>Index</b> .....	34

# Caring for the Product

## The Camera

To ensure continued enjoyment of this Nikon product, observe the precautions described below in addition to the warnings in “For Your Safety” (📖vii-ix) and “<Important> Shockproof, Waterproof, Dustproof, Condensation” (📖xii-xvii) when using or storing the device.

### ✔ Do Not Drop

The product may malfunction if subjected to strong shock or vibration.

### ✔ Do Not Allow Damp to Enter Inside the Camera

This camera is provided with JIS/IEC protection class 8 (IPX8) equivalent waterproofing. If water seeps inside the camera, however, this could cause the components to rust and result in a high repair charge or the camera may not be repairable. After using the camera at the beach or underwater, make sure that the battery-chamber/memory card slot cover is firmly closed, and then immerse the camera in a shallow container filled with fresh water for ten minutes. After using the camera underwater, do not leave the camera wet for 60 minutes or more. This could cause deterioration of the waterproofing performance.

### ✔ Prevent Water from Seeping Inside the Camera

If the inside of the camera becomes wet, this could result in camera malfunction and the camera may not be repairable. To prevent water seeping (water submersion) accidents, make sure to observe the following cautions when using the camera.

- When the battery-chamber/memory card slot cover is closed, make sure that the camera strap, hair, lint, dust, sand grains, other foreign substances, or dirt are not attached on the waterproofing packing and portions that make a contact with the waterproofing packing.
- Do not open and close the battery-chamber/memory card slot cover in areas exposed to water spray, high winds, dust or sand.
- When an external force is applied on the camera, it could become deformed or the airtight seals may become damaged and cause water to seep inside the camera. Do not place a heavy object on the camera, drop the camera, or apply excessive force on the camera.
- If water seeps inside the camera, immediately stop using the camera. Wipe off moisture from the camera, and at once take the camera to your Nikon-authorized service representative.

## **Shock and Vibration**

Do not drop the camera, strike it against a hard object such as a rock, or throw it at a water surface. Do not leave the camera in an area subject to vibration. If the camera is subjected to excessive shock, this could result in camera malfunction or damage.

## **Maximum Depth**

This camera is designed to withstand water pressure up to a depth of 18 m (59 ft) for approximately 60 minutes. At greater depth, water could seep inside the camera, resulting in camera malfunction.

## **Precautions on Handling the Camera in Cold Locations**

- The operation of this camera has been confirmed at temperatures of  $-10^{\circ}\text{C}$  ( $14^{\circ}\text{F}$ ). If the camera is left with snow or water droplets adhered to the exterior, snow or water droplets between the gaps may become frozen and it may be difficult to operate parts of the camera.
- At temperatures from  $-10^{\circ}\text{C}$  to  $0^{\circ}\text{C}$  ( $14^{\circ}\text{F}$  to  $32^{\circ}\text{F}$ ), the performance of the batteries (number of images shot and shooting time) will drop temporarily.
- If the camera becomes extremely cold in cold locations, the monitor performance may drop temporarily immediately after the power is turned on (i.e., the monitor appears darker than usual or a residual image occurs).
- When using the camera in cold locations or at high altitudes, keep the camera warm inside a protection against cold or clothing.

## **Handle the Lens and All Moving Parts with Care**

Do not apply force to the lens, lens cover, monitor, memory card slot, or battery chamber. These parts are easily damaged. Applying force to the lens cover could result in camera malfunction or damage to the lens.

## **Avoid Sudden Changes in Temperature**

Sudden changes in temperature, such as when entering or leaving a heated building on a cold day, can cause condensation to form inside the device. To prevent condensation, place the device in a carrying case or a plastic bag before exposing it to sudden changes in temperature.

Do not expose the camera to high temperatures by leaving it on the beach or in direct sunlight before entering the water.

## **Keep away from Strong Magnetic Fields**

Do not use or store this device in the vicinity of equipment that generates strong electromagnetic radiation or magnetic fields. Strong static charge or the magnetic fields produced by equipment such as radio transmitters could interfere with the monitor, damage data saved on the memory card, or affect the product's internal circuitry.

## **Do Not Point the Lens at Strong Light Sources for Extended Periods**

Avoid pointing the lens at the sun or other strong light sources for extended periods when using or storing the camera. Intense light may cause deterioration of the image sensor, producing a white blur effect in photographs.

## **Turn the Product off Before Removing or Disconnecting the Power Source**

Do not remove the battery while the product is on, or while images are being saved or deleted. Forcibly cutting power in these circumstances could result in loss of data or in damage to product memory or internal circuitry.

## **Notes About the Monitor**

- Monitors and electronic viewfinders are constructed with extremely high precision; at least 99.99% of pixels are effective, with no more than 0.01% being missing or defective. Hence while these displays may contain pixels that are always lit (white, red, blue, or green) or always off (black), this is not a malfunction and has no effect on images recorded with the device.
- Due to the general characteristics of OLED monitors, prolonged or repeated display of the same screen or image may result in screen burn. Screen burn can be recognized by decreased brightness in portions of the monitor or mottled display. In some cases, screen burn may become permanent. However, images are in no way affected by screen burn.  
To prevent screen burn, do not set monitor brightness higher than necessary and do not display the same screen or image for an extended period of time.
- Images in the monitor may be difficult to see under bright lighting.
- The monitor is lit by an LED backlight. Should the monitor begin to dim or flicker, contact your Nikon-authorized service representative.

## **The Battery**

Be sure to read and follow the warnings in "For Your Safety" ( vii-ix) before use.

- Check the battery level before using the camera and replace or charge the battery if necessary. Do not continue charging once the battery is fully charged as this will result in reduced battery performance. Whenever possible, carry a fully charged spare battery when taking images on important occasions.
- Do not use the battery at ambient temperatures below  $-10^{\circ}\text{C}$  ( $14^{\circ}\text{F}$ ) or above  $40^{\circ}\text{C}$  ( $104^{\circ}\text{F}$ ).
- Charge the battery indoors with an ambient temperature of  $5^{\circ}\text{C}$  to  $35^{\circ}\text{C}$  ( $41^{\circ}\text{F}$  to  $95^{\circ}\text{F}$ ) before use.

- When charging the battery inserted into this camera using the charging AC adapter or a computer, the battery is not charged at battery temperatures below 0°C (32°F) or above 45°C (113°F).
- Note that the battery may become hot during use; wait for the battery to cool before charging. Failure to observe these precautions could damage the battery, impair its performance, or prevent it from charging normally.
- On cold days, the capacity of batteries tends to decrease. If an exhausted battery is used at a low temperature, the camera will not turn on. Be sure that the battery is fully charged before heading outside to take images in cold weather. Keep spare batteries in a warm place and exchange as necessary. Once warmed, a cold battery may recover some of its charge.
- Dirt on the battery terminals can prevent the camera from functioning. Should the battery terminals become dirty, wipe them off with a clean, dry cloth before use.
- If the battery will not be used for some time, insert it in the camera and completely exhaust it before removing it for storage. The battery should be stored in a cool location with an ambient temperature of 15°C to 25°C (59°F to 77°F). Do not store the battery in hot or extremely cold locations.
- Always remove the battery from the camera or optional battery charger when it is not being used. When inserted, minute amounts of current are drawn from the battery even when not in use. This may result in excessive draining of the battery and complete loss of function. Turning the camera on or off while the battery is exhausted can result in reduced battery life.
- Recharge the battery at least once every six months and completely exhaust it before returning it to storage.
- After removing the battery from the camera or optional battery charger, put the battery in a plastic bag, etc. to insulate the terminal and store it in a cool place.
- A marked drop in the time a fully-charged battery retains its charge, when used at room temperature, indicates that the battery needs to be replaced. Purchase a new EN-EL12 battery.
- Replace the battery when it no longer holds a charge. Used batteries are a valuable resource. Please recycle used batteries in accordance with local regulations.

## Charging AC Adapter

Be sure to read and follow the warnings in “For Your Safety” (📖vii-ix) before use.

- The Charging AC Adapter EH-71P is for use only with compatible devices. Do not use with another make or model of device.
- Do not use a USB cable other than the UC-E21. Using a USB cable other than the UC-E21 could result in overheating, fire or electric shock.

- Do not, under any circumstances, use another make or model of AC adapter other than Charging AC Adapter EH-71P, and do not use a commercially available USB-AC adapter or a battery charger for a mobile phone. Failure to observe this precaution could result in overheating or in damage to the camera.
- The EH-71P is compatible with AC 100-240 V, 50/60 Hz electrical outlets. When using in other countries, use a plug adapter (available commercially) as necessary. For more information about plug adapters, consult your travel agency.

## Memory Cards

- Use only Secure Digital memory cards. See “Approved Memory Cards” (p.31) for recommended memory cards.
- Observe the precautions noted in the documentation included with your memory card.
- Do not affix labels or stickers to the memory card.
- Do not format the memory card using a computer.
- The first time you insert a memory card that has been used in another device into this camera, be sure to format it with this camera. We recommend formatting new memory cards with this camera before using them with this camera.
- Note that **formatting a memory card permanently deletes all images and other data on the memory card**. If there is data saved on the memory card that you wish to keep, copy that data to a computer before formatting.
- If the message **Card is not formatted. Format card?** is displayed when the camera is turned on, the memory card must be formatted. If there is data on the memory card that you do not want to delete, select **No** and press the **OK** button. Copy that data to a computer before formatting. To format the memory card, select **Yes**.
- Observe the following precautions while formatting the memory card, saving and deleting images, and copying images to a computer, otherwise data or the memory card itself may be damaged.
  - Do not open the battery-chamber/memory card slot cover or remove the memory card or battery.
  - Do not turn off the camera.
  - Do not disconnect the AC adapter.

# Cleaning and Storage

## Cleaning

Do not use alcohol, thinner, or other volatile chemicals.

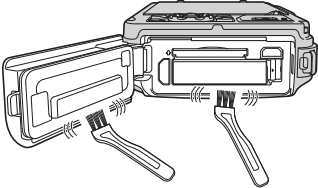
Lens	Avoid touching glass parts with your fingers. Remove dust or lint with a blower (typically a small device with a rubber bulb attached to one end that is pumped to produce a stream of air out the other end). To remove fingerprints or other stains that cannot be removed with a blower, wipe the lens with a soft cloth, using a spiral motion that starts at the center of them and working toward the edges. If this fails, clean the lens using a cloth lightly dampened with commercial lens cleaner.
Monitor	Remove dust or lint with a blower. To remove fingerprints and other stains, clean the monitor with a soft, dry cloth, being careful not to apply pressure.
Body	<p>Use a blower to remove dust, dirt, or sand, then wipe gently with a soft, dry cloth. If a foreign substance adheres to the waterproof packing inside of the battery-chamber/memory card slot cover or inside of the battery chamber, remove it with the included brush. After using the camera underwater, or at the beach or other sandy or dusty environment, wipe off any sand, dust, or salt with a dry cloth lightly dampened with fresh water and dry thoroughly. If you handle the camera using hands where sunscreen lotion is applied, this could cause deterioration of the camera exterior. <b>Note that foreign matter inside the camera could cause damage not covered by the warranty.</b></p> 



### More Information

See “Notes About Waterproof and Dustproof Performances” (📖xii) and “Cleaning after Using the Camera Underwater” (📖xv) for more information.

## Storage

Turn the camera off when not in use. Be sure that the power-on lamp is off before putting the camera away. Remove the battery if the camera will not be used for an extended period. Do not store the camera with naphtha or camphor moth balls, or in any of the following locations:

- Next to equipment that produces strong electromagnetic fields, such as televisions or radios
- Exposed to temperatures below  $-10^{\circ}\text{C}$  ( $14^{\circ}\text{F}$ ) or above  $50^{\circ}\text{C}$  ( $122^{\circ}\text{F}$ )
- Places that are poorly ventilated or subject to humidity of over 60%



To prevent mold or mildew, take the camera out of storage at least once a month. Turn the camera on and release the shutter a few times before putting the camera away again.











For storing the battery, follow the precautions in "The Battery" (🔋:4) in "Caring for the Product" (🔧:2).





# Troubleshooting

If the camera fails to function as expected, check the list of common problems below before consulting your retailer or Nikon-authorized service representative.



## Power, Display, Settings Issues









Problem	Cause/Solution	
<p>The camera is on but does not respond.</p>	<ul style="list-style-type: none"> <li>• Wait for recording to end.</li> <li>• If the problem persists, turn the camera off. If the camera does not turn off, remove and reinsert the battery or batteries or, if you are using an AC adapter, disconnect and reconnect the AC adapter.</li> </ul> <p>Note that although any data currently being recorded will be lost, data that have already been recorded will not be affected by removing or disconnecting the power source.</p>	<p>– 22,  101</p>
<p>Battery inserted in the camera cannot be charged.</p>	<ul style="list-style-type: none"> <li>• Confirm all connections.</li> <li>• When connected to a computer, the camera may not charge for any of the reasons described below.               <ul style="list-style-type: none"> <li>- <b>Off</b> is selected for <b>Charge by computer</b> in the setup menu.</li> <li>- Battery charging stops if the camera is turned off.</li> <li>- Battery charging is not possible if the camera's display language and date and time have not been set, or the date and time were reset after the camera's clock battery was exhausted. Use the charging AC adapter to charge the battery.</li> <li>- Battery charging may stop if the computer is in sleep mode.</li> <li>- Depending upon the computer specifications, settings, and status, battery charging may not be possible.</li> </ul> </li> </ul>	<p>14  77,  75 – 18, 20  – –</p>
<p>Camera cannot be turned on.</p>	<ul style="list-style-type: none"> <li>• The battery is exhausted.</li> <li>• The power switch is enabled a few seconds after the battery is inserted. Wait a few seconds before pressing the power switch.</li> </ul>	<p>22 –</p>









Problem	Cause/Solution	
Camera turns off without warning.	<ul style="list-style-type: none"> <li>The camera automatically turns off to save power (auto off function).</li> <li>The camera or battery has become too cold and cannot operate properly.</li> <li>The inside of the camera has become hot. Leave the camera off until the inside of the camera has cooled, and then try turning it on again.</li> <li>The camera turns off if the USB cable connecting it to a computer or printer is disconnected. Reconnect the USB cable.</li> </ul>	23  :4 – 92, 95,  23
Monitor is blank.	<ul style="list-style-type: none"> <li>The camera is off.</li> <li>The camera has entered standby mode to save power. Press the power switch, shutter-release button,  button,  button, or  (movie-record) button.</li> <li>The flash lamp flashes while the flash is charging. Wait for the flash to charge.</li> <li>The camera and computer are connected via the USB cable.</li> <li>The camera and TV are connected via an HDMI cable.</li> <li>Camera and smart device are connected using Wi-Fi connection and the camera is operated by remote control.</li> </ul>	22 23 48 92, 95 92,  21 89
Monitor is hard to read.	<ul style="list-style-type: none"> <li>Adjust the monitor brightness.</li> <li>The monitor is dirty. Clean the monitor.</li> </ul>	76,  65  :7
Date and time of recording are not correct.	<ul style="list-style-type: none"> <li>If the camera clock has not been set, the “Date not set” indicator flashes during shooting and movie recording. Images and movies saved before the clock is set are dated “00/00/0000 00:00” or “01/01/2014 00:00” respectively. Set the correct time and date from the <b>Time zone and date</b> option in the setup menu.</li> <li>The camera clock is not as accurate as ordinary watches or clocks. Periodically compare the time of the camera clock with that of a more accurate timepiece and reset as required.</li> </ul>	18, 76,  63











Problem	Cause/Solution	
No indicators displayed in monitor.	<b>Hide info</b> is selected for <b>Photo info</b> in <b>Monitor settings</b> in the setup menu.	76,  65
<b>Print date</b> not available.	<b>Time zone and date</b> has not been set in the setup menu.	18, 76,  63
Date not imprinted on images even when <b>Print date</b> is enabled.	<ul style="list-style-type: none"> <li>The current shooting mode does not support <b>Print date</b>.</li> <li>The date cannot be imprinted on movies.</li> </ul>	76,  67
Screen for setting time zone and date is displayed when camera is turned on.	The clock battery is exhausted; all settings were restored to their default values.	18, 20
Camera settings reset.		
Camera becomes hot.	The camera may become hot when used for an extended period of time to record movies or send images using an Eye-Fi card, or when used in a hot environment; this is not a malfunction.	–
Camera makes sound.	Depending on the <b>Autofocus mode</b> setting or the shooting mode, the camera may produce an audible focusing sound.	56, 73
Unable to select a menu	<ul style="list-style-type: none"> <li>Some functions cannot be used with other menu options.</li> <li>Some menus are not available when Wi-Fi is connected. Terminate the Wi-Fi connection.</li> </ul>	58
		91

## Shooting Issues

Problem	Cause/Solution	
Cannot switch to shooting mode.	Disconnect the HDMI cable or USB cable.	92, 95,  21,  23





Problem	Cause/Solution	
No image captured when the shutter-release button is pressed.	<ul style="list-style-type: none"> <li>When the camera is in playback mode, press the  button, the shutter-release button, or the  button.</li> <li>When menus are displayed, press the <b>MENU</b> button.</li> <li>The battery is exhausted.</li> <li>When the flash lamp is flashing, the flash is charging.</li> <li>The camera and smart device are connected using Wi-Fi connection and the camera is operated by remote control.</li> </ul>	30  6  22 48  89
Camera cannot focus.	<ul style="list-style-type: none"> <li>The subject is too close. Try shooting with macro mode,  (easy auto) mode or <b>Close-up</b> scene mode.</li> <li>The subject is hard to focus on.</li> <li>Set <b>AF assist</b> in the setup menu to <b>Auto</b>.</li> <li>Turn the camera off and then on again.</li> </ul>	33, 37, 51  63 76,  69 22
Images are blurred.	<ul style="list-style-type: none"> <li>Use the flash.</li> <li>Increase the ISO sensitivity value.</li> <li>Enable vibration reduction or motion detection.</li> <li>Use <b>BSS</b> (Best Shot Selector).</li> <li>Use a tripod to stabilize the camera when shooting (using the self-timer at the same time is more effective).</li> </ul>	48 56 76  38, 56,  34 50
Bright specks appear in images captured with flash.	The flash is reflecting off particles in the air. Set the flash mode setting to  (off).	49
Flash does not fire.	<ul style="list-style-type: none"> <li>The flash mode is set to  (off).</li> <li>A shooting mode that restricts the flash is selected.</li> <li><b>On</b> is selected for <b>Blink proof</b> in the smart portrait menu.</li> <li><b>On</b> is selected for <b>Smile timer</b> in the smart portrait menu.</li> <li>A function that restricts the flash is enabled.</li> </ul>	48 53  57 57 58







Problem	Cause/Solution	
Digital zoom cannot be used.	<ul style="list-style-type: none"> <li>• <b>Digital zoom</b> is set to <b>Off</b> in the setup menu.</li> <li>• Digital zoom cannot be used in the following situations.               <ul style="list-style-type: none"> <li>- When the scene mode is <b>Portrait, Night portrait, Night landscape, Backlighting</b> (when <b>HDR</b> is <b>ON</b>), <b>Easy panorama, Pet portrait</b>, or <b>Underwater</b>.</li> <li>- When smart portrait mode is selected</li> <li>- When <b>Continuous</b> in the shooting menu is set to <b>Multi-shot 16</b></li> <li>- When <b>AF area mode</b> in the shooting menu is set to <b>Subject tracking</b></li> </ul> </li> <li>• Other functions that restrict the use of digital zoom are set.</li> </ul>	76,  70  35  44 56,  34 56,  38 58
<b>Image mode</b> not available.	A function that restricts the <b>Image mode</b> option is enabled.	58
No sound when shutter is released.	<b>Off</b> is selected for <b>Sound settings &gt; Shutter sound</b> in the setup menu. No sound is produced with some shooting modes and settings, even when <b>On</b> is selected.	76,  70
AF-assist illuminator does not light.	<b>Off</b> is selected for the <b>AF assist</b> option in the setup menu. AF-assist illuminator may not light depending on the position of the focus area or the current scene mode, even when <b>Auto</b> is selected.	76,  69
Images appear smeared.	The lens is dirty. Clean the lens.	 7
Colors are unnatural.	White balance or hue is not adjusted properly.	37, 56,  32
Randomly spaced bright pixels ("noise") appear in image.	The subject is dark, and the shutter speed is too slow or ISO sensitivity is too high. Noise can be reduced by: <ul style="list-style-type: none"> <li>• Using the flash.</li> <li>• Specifying a lower ISO sensitivity setting.</li> </ul>	48 56,  37

Problem	Cause/Solution	
Images are too dark (underexposed).	<ul style="list-style-type: none"> <li>The flash mode is set to  (off).</li> <li>The flash window is blocked.</li> <li>The subject is beyond the range of the flash.</li> <li>Adjust exposure compensation.</li> <li>Increase ISO sensitivity.</li> <li>The subject is backlit. Set the scene mode to <b>Backlighting</b> with <b>HDR</b> set to <b>OFF</b>, or set the flash mode to  (fill flash).</li> </ul>	48 26 48  52 56,  37 38, 48
Images are too bright (overexposed).	Adjust exposure compensation.	52
Unexpected results when flash set to  (auto with red-eye reduction).	When taking images with  (auto with red-eye reduction), In-Camera Red Eye Fix may be applied to areas not affected by red-eye in rare cases. Use any shooting mode other than <b>Night portrait</b> , and change the flash mode to any setting other than  (auto with red-eye reduction) and try taking an image again.	36, 48
Skin tones are not softened.	<ul style="list-style-type: none"> <li>In some shooting conditions, facial skin tones may not be softened.</li> <li>For images containing four or more faces, try using the <b>Skin softening</b> effect in <b>Glamour retouch</b> in the playback menu.</li> </ul>	44  67,  17
Saving images takes time.	It may take more time to save images in the following situations. <ul style="list-style-type: none"> <li>When the noise reduction function is in operation, such as when shooting in a dark environment</li> <li>When the flash mode is set to  (auto with red-eye reduction)</li> <li>When taking images in the following scene modes                             <ul style="list-style-type: none"> <li><b>Hand-held</b> in <b>Night portrait</b></li> <li><b>Hand-held</b> in <b>Night landscape</b></li> <li><b>HDR</b> set to <b>ON</b> in <b>Backlighting</b></li> <li><b>Easy panorama</b></li> </ul> </li> <li>When the skin softening function is applied while shooting</li> <li>When using continuous shooting mode</li> </ul>	–  49  36 37 38 39 57  56,  34







Problem	Cause/Solution	
A ring-shaped belt or rainbow-colored stripe appears in the monitor or images.	When shooting with backlighting or when a very strong light source (such as sunlight) is in the frame, a ring-shaped belt or rainbow-colored stripe (ghosting) may occur. Change the position of the light source, or frame the image so that the light source does not enter the frame, and try again.	-





## Playback Issues





Problem	Cause/Solution	
File cannot be played back.	<ul style="list-style-type: none"> <li>This camera may not be able to play back images saved with another make or model of digital camera.</li> <li>This camera cannot play back movies recorded with another make or model of digital camera.</li> <li>This camera may not be able to play back data edited on a computer.</li> </ul>	-
Cannot zoom in on image.	<ul style="list-style-type: none"> <li>Playback zoom cannot be used with movies.</li> <li>When zooming in on a small-sized image, the zoom ratio shown on the screen may differ from the actual zoom ratio of the image.</li> <li>This camera may not be able to zoom in on images captured with another make or model of digital camera.</li> </ul>	-
Cannot record voice memos.	<ul style="list-style-type: none"> <li>Voice memos cannot be attached to movies.</li> <li>Voice memos cannot be attached to images captured with other cameras. Voice memos attached to images using another camera cannot be played back on this camera.</li> </ul>	- 67,  51
Cannot edit image.	<ul style="list-style-type: none"> <li>Some images cannot be edited. Images that have already been edited may not be edited again.</li> <li>There is not enough free space in the internal memory or on the memory card.</li> <li>This camera is unable to edit images captured with other cameras.</li> <li>Editing functions used for images are not available for movies.</li> </ul>	39,  13 - 67,  13 -

Problem	Cause/Solution	
Cannot rotate image.	<ul style="list-style-type: none"> <li>This camera cannot rotate images captured with another make or model of digital camera.</li> <li>Images edited using <b>Data imprint</b> cannot be rotated.</li> </ul>	–  67,  18
Images are not displayed on TV.	<ul style="list-style-type: none"> <li><b>HDMI</b> is not correctly set in the <b>TV settings</b> setup menu.</li> <li>A computer or printer is connected to the camera.</li> <li>The memory card contains no images. Replace the memory card. Remove the memory card to play back images from the internal memory.</li> </ul>	77,  74 92, 95,  23 17
Nikon Transfer 2 does not start when camera is connected to a computer.	<ul style="list-style-type: none"> <li>The camera is off.</li> <li>The battery is exhausted.</li> <li>The USB cable is not correctly connected.</li> <li>The camera is not recognized by the computer.</li> <li>The computer is not set to start Nikon Transfer 2 automatically. For more information about Nikon Transfer 2, refer to help information contained in ViewNX 2.</li> </ul>	22 22 92, 95 –  97
The PictBridge startup screen is not displayed when the camera is connected to a printer.	With some PictBridge-compatible printers, the PictBridge startup screen may not be displayed and it may be impossible to print images when <b>Auto</b> is selected for the <b>Charge by computer</b> option in the setup menu. Set the <b>Charge by computer</b> option to <b>Off</b> and reconnect the camera to the printer.	77,  75
Images to be printed are not displayed.	<ul style="list-style-type: none"> <li>The memory card contains no images. Replace the memory card.</li> <li>Remove the memory card to print images from the internal memory.</li> </ul>	16  17
Cannot select paper size with camera.	The camera cannot be used to select the paper size in the following situations, even when printing from a PictBridge-compatible printer. Use the printer to select the paper size. <ul style="list-style-type: none"> <li>The printer does not support the paper sizes specified by the camera.</li> <li>The printer automatically selects the paper size.</li> </ul>	92,  25,  26 –

## Location Data Functions

Problem	Cause/Solution	
<p>Unable to identify the location or it takes time to identify the location.</p>	<ul style="list-style-type: none"> <li>The camera may not be able to identify the location in some shooting environments. To use the location data functions, use the camera as much as possible in an open-air area.</li> <li>When positioning for the first time or when positioning was unable to be performed for about two hours, it takes a few minutes to obtain the location data.</li> </ul>	<p>79 79</p>
<p>Unable to record location data on shot images.</p>	<p>When  or  is displayed on the shooting screen, the location data is not recorded. Before shooting images, check the location data reception.</p>	<p>80</p>
<p>Difference between the actual shooting location and recorded location data.</p>	<p>The acquired location data may deviate in some shooting environments. When there is a significant difference in the signals from the positioning satellites, there could be a deviation of up to several hundred meters.</p>	<p>79</p>
<p>The recorded location name is different from the intended one or is not displayed.</p>	<p>The desired landmark name may not be registered, or a different landmark name may be registered.</p>	<p>-</p>
<p>Unable to update the A-GPS file.</p>	<ul style="list-style-type: none"> <li>Check the following items.                             <ul style="list-style-type: none"> <li>Whether the memory card is inserted</li> <li>Whether the A-GPS file is stored on the memory card</li> <li>Whether the A-GPS file saved on the memory card is more recent than the A-GPS file saved in the camera</li> <li>Whether the A-GPS file is still valid</li> </ul> </li> <li>The A-GPS file may be corrupted. Download the file from the website once more.</li> </ul>	<p>- 87, 79</p>
<p>Unable to display the map.</p>	<p>Maps cannot be displayed while the camera is being charged with the charging AC adapter, even if the  (map) button is pressed.</p>	<p>-</p>
<p>Unable to turn off the altimeter or depth gauge.</p>	<p>When <b>Altimeter/depth gauge</b> of <b>Altitude/depth options</b> in the Location data options menu is set to <b>On</b>, the altimeter or depth gauge is always displayed regardless of <b>Monitor settings</b> in the setup menu. To turn off the altimeter or depth gauge, set the <b>Altimeter/depth gauge</b> to <b>Off</b>.</p>	<p>88, 91</p>

Problem	Cause/Solution	
The altimeter or depth gauge and atmospheric pressure icon remain displayed on the shooting screen.	Set <b>Photo info</b> of <b>Monitor settings</b> in the setup menu to <b>Hide info</b> .	76,  65
Unable to display the altimeter or depth gauge even when <b>Altimeter/depth gauge</b> is set to <b>On</b> .	<p>Even when <b>Altimeter/depth gauge</b> is set to <b>On</b>, the altimeter or depth gauge is not displayed in the following situations.</p> <ul style="list-style-type: none"> <li>• When the shutter-release button is pressed halfway</li> <li>• During shooting in the <b>Easy panorama</b> scene mode</li> <li>• During movie recording</li> <li>• When a subject is registered using <b>Subject tracking</b> of <b>AF area mode</b></li> <li>• When a message is being displayed</li> </ul>	– 39 69 55,  38 –
Water depth shows 0 m	The water depth will be displayed as 0 m if the camera is not submerged under water when the <b>Underwater</b> scene mode is selected.	41
Unable to select <b>Use location data</b> of <b>Alt./depth correction</b> in the Location data options menu.	<ul style="list-style-type: none"> <li>• <b>Record location data</b> in the Location data options menu is set to <b>Off</b>.</li> <li>• You cannot select this function unless signals are received from four or more satellites and positioning has been performed.</li> <li>• The camera is submerged under water. You cannot select this function during underwater shooting.</li> </ul>	78 80 –
Unable to select <b>Create log</b> in the Location data options menu.	Clock not set. Set date and time.	76,  63
Unable to select <b>Start all logs</b> or <b>Start location log</b> .	<ul style="list-style-type: none"> <li>• <b>Record location data</b> in the Location data options menu is set to <b>Off</b>.</li> <li>• The camera is recording log data. To record a new log, select <b>End all logs</b> or <b>End location log</b>, and end the log currently being recorded.</li> </ul>	78 88,  83

Problem	Cause/Solution	
Unable to save log data.	<ul style="list-style-type: none"> <li>• Make sure that a memory card is inserted in the camera.</li> <li>• Up to 36 log data events for location data logs can be recorded per day whereas up to 34 log data events each for altitude logs and water depth logs can be recorded per day.</li> <li>• The total number of log data events that can be saved on a single memory card is 200, which includes up to 100 log data events for location data logs and up to 100 log data events for a combined total of altitude logs and water depth logs. Delete log data that is no longer required from a memory card or replace the memory card with a new one.</li> </ul>	<p>–</p> <p>–</p> <p>85, 86</p>
Unable to display the water depth log as a graph	Log files are created but are not displayed as graphs if you selected <b>Start depth log</b> but did not submerge the camera under water.	 86

## Wi-Fi

Problem	Cause/Solution	
SSID (network name) of the camera is not displayed on the smart device.	<p>Select <b>Connect to smart device</b> in the Wi-Fi options menu on the camera to enter connection standby mode.</p> <p>Turn off the Wi-Fi function of the smart device and then turn it on again.</p>	90

# USER LICENSE AGREEMENT FOR MAP DATA AND LOCATION NAME DATA

The map data and location name data that are stored in this digital camera ("Data") is provided for your personal, internal use only and not for resale. It is protected by copyright, and is subject to the following terms and conditions which are agreed to by you, on the one hand, and Nikon Corporation ("Nikon") and its licensors (including their licensors and suppliers) on the other hand.

## Terms and Conditions

Personal Use Only. You agree to use this Data together with this digital camera and the image data taken by the digital camera for the solely personal, non-commercial purposes for which you were licensed, and not for service bureau, time-sharing or other similar purposes.

Accordingly, but subject to the restrictions set forth in the following paragraphs, you agree not to otherwise reproduce, copy, modify, decompile, disassemble or reverse engineer any portion of this Data, and may not transfer or distribute it in any form, for any purpose, except to the extent permitted by mandatory laws.

Restrictions. Except where you have been specifically licensed to do so by Nikon, and without limiting the preceding paragraph, you may not (a) use this Data with any products, systems, or applications installed or otherwise connected to or in communication with vehicles, capable of vehicle navigation, positioning, dispatch, real time route guidance, fleet management or similar applications; or (b) with or in communication with any positioning devices or any mobile or wireless-connected electronic or computer devices, including without limitation cellular phones, palmtop and handheld computers, pagers, and personal digital assistants or PDAs.

Warning. The Data may contain inaccurate or incomplete information due to the passage of time, changing circumstances, sources used and the nature of collecting comprehensive geographic data, any of which may lead to incorrect results.

No Warranty. This Data is provided to you "as is," and you agree to use it at your own risk. Nikon and its licensors (and their licensors and suppliers) make no guarantees, representations or warranties of any kind, express or implied, arising by law or otherwise, including but not limited to, content, quality, accuracy, completeness, effectiveness, reliability, fitness for a particular purpose, usefulness, use or results to be obtained from this Data, or that the Data or server will be uninterrupted or error-free.

Disclaimer of Warranty: NIKON AND ITS LICENSORS (INCLUDING THEIR LICENSORS AND SUPPLIERS) DISCLAIM ANY WARRANTIES, EXPRESS OR IMPLIED, OF QUALITY, PERFORMANCE, MERCHANTABILITY, FITNESS FOR A PARTICULAR PURPOSE OR NON-INFRINGEMENT. Some States, Territories and Countries do not allow certain warranty exclusions, so to that extent the above exclusion may not apply to you.

**Disclaimer of Liability:** NIKON AND ITS LICENSORS (INCLUDING THEIR LICENSORS AND SUPPLIERS) SHALL NOT BE LIABLE TO YOU: IN RESPECT OF ANY CLAIM, DEMAND OR ACTION, IRRESPECTIVE OF THE NATURE OF THE CAUSE OF THE CLAIM, DEMAND OR ACTION ALLEGING ANY LOSS, INJURY OR DAMAGES, DIRECT OR INDIRECT, WHICH MAY RESULT FROM THE USE OR POSSESSION OF THE INFORMATION; OR FOR ANY LOSS OF PROFIT, REVENUE, CONTRACTS OR SAVINGS, OR ANY OTHER DIRECT, INDIRECT, INCIDENTAL, SPECIAL OR CONSEQUENTIAL DAMAGES ARISING OUT OF YOUR USE OF OR INABILITY TO USE THIS INFORMATION, ANY DEFECT IN THE INFORMATION, OR THE BREACH OF THESE TERMS OR CONDITIONS, WHETHER IN AN ACTION IN CONTRACT OR TORT OR BASED ON A WARRANTY, EVEN IF NIKON OR ITS LICENSORS HAVE BEEN ADVISED OF THE POSSIBILITY OF SUCH DAMAGES. Some States, Territories and Countries do not allow certain liability exclusions or damages limitations, so to that extent the above may not apply to you.

**Export Control.** You agree not to export from anywhere any part of the Data or any direct product thereof except in compliance with, and with all licenses and approvals required under, applicable export laws, rules and regulations, including but not limited to the laws, rules and regulations administered by the Office of Foreign Assets Control of the U.S. Department of Commerce and the Bureau of Industry and Security of the U.S. Department of Commerce. To the extent that any such export laws, rules or regulations prohibit Nikon and its licensors from complying with any of its obligations hereunder to deliver or distribute Data, such failure shall be excused and shall not constitute a breach of this Agreement.

**Entire Agreement.** These terms and conditions constitute the entire agreement between Nikon (and its licensors, including their licensors and suppliers) and you pertaining to the subject matter hereof, and supersedes in their entirety any and all written or oral agreements previously existing between us with respect to such subject matter.

**Governing Law.** The above terms and conditions shall be governed by the laws of the Japan, without giving effect to (i) its conflict of laws provisions, or (ii) the United Nations Convention for Contracts for the International Sale of Goods, which is explicitly excluded; provided that in the event that the laws of the Japan is not deemed applicable to this Agreement for any reason in the country where you obtained the Data, this Agreement shall be governed with the laws of the country where you obtained the Data. You agree to submit to the jurisdiction of Japan for any and all disputes, claims and actions arising from or in connection with the Data provided to you hereunder.

Government End Users. If the Data supplied by HERE is being acquired by or on behalf of the United States government or any other entity seeking or applying rights similar to those customarily claimed by the United States government, the Data is a "commercial item" as that term is defined at 48 C.F.R. ("FAR") 2.101, is licensed in accordance with the End-User Terms under which this Data was provided, and each copy of the Data delivered or otherwise furnished shall be marked and embedded as appropriate with the following "Notice of Use," and shall be treated in accordance with such Notice:

NOTICE OF USE  
CONTRACTOR (MANUFACTURER/ SUPPLIER) NAME:  
HERE  
CONTRACTOR (MANUFACTURER/ SUPPLIER) ADDRESS:  
425 West Randolph Street, Chicago, Illinois 60606  
This Data is a commercial item as defined in  
FAR 2.101 and is subject to the End-User  
Terms under which this Data was provided.  
© 2013 HERE - All rights reserved.

If the Contracting Officer, federal government agency, or any federal official refuses to use the legend provided herein, the Contracting Officer, federal government agency, or any federal official must notify HERE prior to seeking additional or alternative rights in the Data.

## Notices related to licensed software copyright holders.

- Map data and location name data for Japan



© 2013 ZENRIN CO., LTD. All rights reserved.  
This service uses map and POI data of ZENRIN CO., LTD.  
"ZENRIN" is a registered trademark of ZENRIN CO., LTD.

- Map data and location name data except for Japan



Maps for Life

© 1987-2013 HERE  
All rights reserved.

Austria	© Bundesamt für Eich- und Vermessungswesen
Croatia Cyprus Estonia Latvia Lithuania Moldova Poland Slovenia Ukraine	© EuroGeographics
France	source: © IGN 2009 - BD TOPO ®
Germany	Die Grundlagendaten wurden mit Genehmigung der zuständigen Behörden entnommen
Great Britain	Contains Ordnance Survey data © Crown copyright and database right 2010 Contains Royal Mail data © Royal Mail copyright and database right 2010

Greece	Copyright Geomatics Ltd.
Hungary	Copyright © 2003; Top-Map Ltd.
Italy	La Banca Dati Italiana è stata prodotta usando quale riferimento anche cartografia numerica ed al tratto prodotta e fornita dalla Regione Toscana.
Norway	Copyright © 2000; Norwegian Mapping Authority
Portugal	Source: IgeoE - Portugal
Spain	Información geográfica propiedad del CNIG
Sweden	Based upon electronic data © National Land Survey Sweden.
Switzerland	Topografische Grundlage: © Bundesamt für Landestopographie
United Kingdom	Contains public sector information licensed under the Open Government Licence v1.0 (see for the license <a href="http://www.nationalarchives.gov.uk/doc/open-government-licence/">http://www.nationalarchives.gov.uk/doc/open-government-licence/</a> ) Adapted from data from the office for National Statistics licensed under the Open Government Licence v.1.0
Canada	This data includes information taken with permission from Canadian authorities, including © Her Majesty, © Queen's Printer for Ontario, © Canada Post, GeoBase ®, © Department of Natural Resources Canada. All rights reserved.
Mexico	Fuente: INEGI (Instituto Nacional de Estadística y Geografía.)
United States	© United States Postal Service ® 2013. Prices are not established, controlled or approved by the United States Postal Service ®. The following trademarks and registrations are owned by the USPS: United States Postal Service, USPS, and ZIP+4.
Australia	Copyright. Based on data provided under license from PSMA Australia Limited ( <a href="http://www.pasma.com.au">www.pasma.com.au</a> ). Product incorporates data which is © 2013 Telstra Corporation Limited, Intelomatics Australia Pty Ltd and HERE International LLC.
Nepal	Copyright © Survey Department, Government of Nepal.
Sri Lanka	This product incorporates original source digital data obtained from the Survey Department of Sri Lanka © 2009 Survey Department of Sri Lanka The data has been used with the permission of the Survey Department of Sri Lanka

<b>Israel</b>	© Survey of Israel data source
<b>Jordan</b>	© Royal Jordanian Geographic Centre.
<b>Mozambique</b>	Certain Data for Mozambique provided by Cenacarta © 2013 by Cenacarta
<b>Nicaragua</b>	The Pacific Ocean and Caribbean Sea maritime borders have not been entirely defined. Northern land border defined by the natural course of the Coco River (also known as Segovia River or Wangki River) corresponds to the source of information available at the moment of its representation.
<b>Réunion</b>	source: © IGN 2009 - BD TOPO ®
<b>Ecuador</b>	INSTITUTO GEOGRAFICO MILITAR DEL ECUADRO AUTORIZACION N° IGM-2011-01- PCO-01 DEL 25 DE ENERO DE 2011
<b>Guadeloupe</b>	source: © IGN 2009 - BD TOPO ®
<b>Guatemala</b>	Aprobado por el INSTITUTO GEOGRAFICO NACIONAL - Resolución del IGN N° 186-2011
<b>French Guiana</b>	source: © IGN 2009 - BD TOPO ®
<b>Martinique</b>	source: © IGN 2009 - BD TOPO ®

# Specifications

## Nikon COOLPIX AW120 Digital Camera

Type	Compact digital camera
Number of effective pixels	16.0 million
Image sensor	1/2.3-in. type CMOS; approx. 16.76 million total pixels
Lens	NIKKOR lens with 5x optical zoom
Focal length	4.3-21.5 mm (angle of view equivalent to that of 24-120 mm lens in 35mm [135] format)
f/-number	f/2.8-4.9
Construction	12 elements in 10 groups (2 ED lens elements)
Digital zoom magnification	Up to 4x (angle of view equivalent to that of approx. 480 mm lens in 35mm [135] format)
Vibration reduction	Combination of lens shift and electronic VR
Motion blur reduction	Motion detection (still pictures)
Autofocus (AF)	Contrast-detect AF
Focus range	<ul style="list-style-type: none"><li>• [W]: Approx. 50 cm (1 ft 8 in.) - ∞,</li><li>  [T]: Approx. 50 cm (1 ft 8 in.) - ∞</li><li>• Macro mode: Approx. 1 cm (0.4 in.) - ∞ (wide-angle position)</li></ul> (All distances measured from center of front surface of lens)
Focus-area selection	Face priority, manual with 99 focus areas, center, subject tracking, target finding AF
Monitor	7.5 cm (3-in.), approx. 921k-dot, OLED monitor with anti-reflection coating and 5-level brightness adjustment
Frame coverage (shooting mode)	Approx. 98% horizontal and 98% vertical (compared to actual picture)
Frame coverage (playback mode)	Approx. 100% horizontal and 100% vertical (compared to actual picture)
Storage	
Media	Internal memory (approx. 329 MB) SD/SDHC/SDXC memory card
File system	DCF, Exif 2.3, and DPOF compliant
File formats	Still pictures: JPEG Sound files (voice memo): WAV Movies: MOV (video: H.264/MPEG-4 AVC, Audio: LPCM stereo)

Image size (pixels)	<ul style="list-style-type: none"> <li>• 16M (High) <b>4608×3456★</b></li> <li>• 16M <b>4608×3456</b></li> <li>• 8M <b>3264×2448</b></li> <li>• 4M <b>2272×1704</b></li> <li>• 2M <b>1600×1200</b></li> <li>• VGA <b>640×480</b></li> <li>• 16:9 12M <b>4608×2592</b></li> <li>• 1:1 <b>3456×3456</b></li> </ul>
ISO sensitivity (Standard output sensitivity)	<ul style="list-style-type: none"> <li>• ISO 125 - 1600</li> <li>• ISO 3200, 6400 (available when using Auto mode)</li> </ul>
Exposure	
Metering mode	Matrix, center-weighted (digital zoom less than 2×), spot (digital zoom 2× or more)
Exposure control	Programmed auto exposure and exposure compensation (-2.0 - +2.0 EV in steps of $\frac{1}{3}$ EV)
Shutter	Mechanical and CMOS electronic shutter
Speed	<ul style="list-style-type: none"> <li>• 1/1500 - 1 s</li> <li>• 1/4000 s (maximum speed during high-speed continuous shooting)</li> <li>• 4 s (<b>Fireworks show</b> scene mode)</li> </ul>
Aperture	Electronically-controlled preset aperture (-1 AV) and ND filter (-2 AV) selections
Range	3 steps (f/2.8, f/4.1, f/8.2 [W])
Self-timer	Can be selected from 10 s and 2 s
Flash	
Range (approx.) (ISO sensitivity: Auto)	[W]: 0.5 - 5.2 m (1 ft 8 in. - 17 ft) [T]: 0.5 - 4.5 m (1 ft 8 in. - 14 ft)
Flash control	TTL auto flash with monitor preflashes
Interface	Hi-Speed USB equivalent
Data transfer protocol	MTP, PTP
HDMI output	Can be selected from Auto, 480p, 720p, and 1080i
I/O terminal	<ul style="list-style-type: none"> <li>• Micro-USB connector</li> <li>• HDMI micro connector (Type D) (HDMI output)</li> </ul>

<b>Wi-Fi (Wireless LAN)</b>	
Standards	IEEE 802.11b/g/n (standard wireless LAN protocol) ARIB STD-T66 (standard for low power data communication systems)
Communications protocols	IEEE 802.11b: DBPSK/DQPSK/CCK IEEE 802.11g: OFDM IEEE 802.11n: OFDM
Range (line of sight)	Approx. 30 m (32 yd)
Operating frequency	2412 - 2462 MHz (1 - 11 channels)
Data rates (actual measured values)	IEEE 802.11b: 5 Mbps IEEE 802.11g: 17 Mbps IEEE 802.11n: 17 Mbps
Security	OPEN/WPA2
Access protocols	CSMA/CA
<b>Electronic compass</b>	16 cardinal points (position correction using 3-axis acceleration sensor, automatic correction for the deviated angle, and automatic offset adjustment)
<b>Location data</b>	<ul style="list-style-type: none"> <li>• <b>GPS</b> Receiving frequency: 1575.42 MHz Geodetic system: WGS 84</li> <li>• <b>GLONASS</b> Receiving frequency: 1598.0625 - 1605.3750 MHz Geodetic system: WGS 84</li> </ul>
<b>Barometer</b>	Operating range: Approx. 500 - 1100 hPa
<b>Altimeter</b>	Operating range: Approx. -300 - +4500 m (-984 - +14,760 ft)
<b>Depth gauge</b>	Operating range: Approx. 0 - 20 m (0 - 65 ft)
<b>Supported languages</b>	Arabic, Bengali, Bulgarian, Chinese (Simplified and Traditional), Czech, Danish, Dutch, English, Finnish, French, German, Greek, Hindi, Hungarian, Indonesian, Italian, Japanese, Korean, Marathi, Norwegian, Persian, Polish, Portuguese (European and Brazilian), Romanian, Russian, Serbian, Spanish, Swedish, Tamil, Telugu, Thai, Turkish, Ukrainian, Vietnamese
<b>Power sources</b>	One Rechargeable Li-ion Battery EN-EL12 (included) AC Adapter EH-62F (available separately)
<b>Charging time</b>	Approx. 2 h 20 min (when using Charging AC Adapter EH-71P and when no charge remains)

<b>Battery life<sup>1</sup></b>	
Still pictures	Approx. 350 shots when using EN-EL12
Movies (actual battery life for recording) <sup>2</sup>	Approx. 1 h 15 min (1080/30p) when using EN-EL12 Approx. 1 h 20 min (1080/25p) when using EN-EL12
Tripod socket	1/4 (ISO 1222)
Dimensions (W × H × D)	Approx. 110.1 × 66.0 × 25.8 mm (4.4 × 2.6 × 1.1 in.) (excluding projections)
Weight	Approx. 213 g (7.5 oz) (including battery and SD memory card)
<b>Operating environment</b>	
Temperature	-10°C - +40°C (14°F - 104°F) (land) 0°C - 40°C (32°F - 104°F) (underwater)
Humidity	85% or less (no condensation)
<b>Waterproof</b>	JIS/IEC protection class 8 (IPX8) equivalent (under our testing conditions) Capacity to shoot images underwater up to a depth of 18 m (59 ft) and for 60 minutes
<b>Dustproof</b>	JIS/IEC protection class 6 (IP6X) equivalent (under our testing conditions)
<b>Shockproof</b>	Cleared our testing conditions <sup>3</sup> compliant with MIL-STD 810F Method 516.5-Shock

- Unless otherwise stated, all figures assume a fully-charged battery and an ambient temperature of 23 ±3°C (73.4 ±5.4°F) as specified by the Camera and Imaging Products Association (CIPA).

- <sup>1</sup> Battery life may vary depending on conditions of use, such as the interval between shots or the length of time that menus and images are displayed.
- <sup>2</sup> Individual movie files cannot exceed 4 GB in size or 29 minutes in length. Recording may end before this limit is reached if camera temperature becomes elevated.
- <sup>3</sup> Dropped from a height of 202 cm (6 ft 6 in.) onto a surface of 5 cm (2 in.) thick plywood (changes in appearance, such as paint peeling off and deformation of the drop shock portion and waterproof performance are not subject to the test). These tests do not guarantee that the camera will be free from damage or trouble under all conditions.

## Rechargeable Li-ion Battery EN-EL12

Type	Rechargeable lithium-ion battery
Rated capacity	DC 3.7 V, 1050 mAh
Operating temperature	0°C - 40°C (32°F - 104°F)
Dimensions (W × H × D)	Approx. 32 × 43.8 × 7.9 mm (1.3 × 1.7 × 0.3 in.)
Weight	Approx. 22.5 g (0.8 oz)

## Charging AC Adapter EH-71P

Rated input	AC 100 V–240 V, 50/60 Hz, MAX 0.2 A
Rated output	DC 5.0 V, 1.0 A
Operating temperature	0°C - 40°C (32°F - 104°F)
Dimensions (W × H × D)	Approx. 55 × 22 × 54 mm (2.2 × 0.9 × 2.2 in.) (excluding plug adapter) For Argentina: Approx. 55 × 63 × 59 mm (2.2 × 2.5 × 2.4 in.) For Brazil: Approx. 55 × 67 × 59 mm (2.2 × 2.7 × 2.4 in.)
Weight	Approx. 48 g (1.7 oz) (excluding plug adapter) For Argentina: Approx. 73 g (2.6 oz) For Brazil: Approx. 70 g (2.5 oz)

### Specifications

- Nikon will not be held liable for any errors this manual may contain.
- The appearance of this product and its specifications are subject to change without notice.

## Approved Memory Cards

The following Secure Digital (SD) memory cards have been tested and approved for use in this camera.

- Memory cards with an SD Speed Class rating of 6 or faster are recommended for recording movies. When using a memory card with a lower Speed Class rating, movie recording may stop unexpectedly.

	SD memory card	SDHC memory card <sup>2</sup>	SDXC memory card <sup>3</sup>
SanDisk	2 GB <sup>1</sup>	4 GB, 8 GB, 16 GB, 32 GB	64 GB, 128 GB
TOSHIBA	–	4 GB, 8 GB, 16 GB, 32 GB	64 GB
Panasonic	2 GB <sup>1</sup>	4 GB, 8 GB, 16 GB, 32 GB	64 GB
Lexar	–	4 GB, 8 GB, 16 GB, 32 GB	64 GB, 128 GB

<sup>1</sup> If the memory card will be used with a card reader or similar device, make sure that the device supports 2 GB cards.

<sup>2</sup> SDHC compliant.

If the memory card will be used with a card reader or similar device, make sure that the device supports SDHC.



<sup>3</sup> SDXC compliant.

If the memory card will be used with a card reader or similar device, make sure that the device supports SDXC.



- Contact the manufacturer for details on the above cards. We cannot guarantee camera performance when using memory cards made by other manufacturers.

## AVC Patent Portfolio License

This product is licensed under the AVC Patent Portfolio License for the personal and non-commercial use of a consumer to (i) encode video in compliance with the AVC standard (“AVC video”) and/or (ii) decode AVC video that was encoded by a consumer engaged in a personal and non-commercial activity and/or was obtained from a video provider licensed to provide AVC video. No license is granted or shall be implied for any other use. Additional information may be obtained from MPEG LA, L.L.C.

See <http://www.mpegla.com>.

## FreeType License (FreeType2)

Portions of this software are copyright © 2012 The FreeType Project (<http://www.freetype.org>). All rights reserved.

## MIT License (HarfBuzz)

Portions of this software are copyright © 2014 The HarfBuzz Project (<http://www.freedesktop.org/wiki/Software/HarfBuzz>). All rights reserved.

## Trademark Information

































- Microsoft, Windows and Windows Vista are either registered trademarks or trademarks of Microsoft Corporation in the United States and/or other countries.
- Mac, OS X, the iFrame logo and the iFrame symbol are trademarks or registered trademarks of Apple Inc., in the U.S. and other countries.
- Adobe and Acrobat are registered trademarks of Adobe Systems Inc.
- SDXC, SDHC and SD Logos are trademarks of SD-3C, LLC.
- PictBridge is a trademark.
- HDMI, HDMI logo and High-Definition Multimedia Interface are trademarks or registered trademarks of HDMI Licensing LLC.

### **HDMI**

- Wi-Fi and the Wi-Fi logo are trademarks or registered trademarks of the Wi-Fi Alliance.
- Android and Google Play are trademarks or registered trademarks of Google, Inc.
- All other trade names mentioned in this manual or the other documentation provided with your Nikon product are trademarks or registered trademarks of their respective holders.











# Index

## Symbols





-  Action Button ..... 2, 4
-  Auto mode ..... 24, 45
-  Auto sort mode .....  9
-  Delete button ..... 31, 75,  51
-  Easy Auto Mode ..... 33
-  Exposure compensation ..... 52
-  Favorite pictures mode .....  5
-  Flash mode ..... 48
-  Help ..... 35
-  List by date mode .....  10
-  Macro mode ..... 51
-  Map button ..... 82
- MENU** Menu button  
..... 6, 55, 67, 73, 76, 87
-  (  movie-record) button  
..... 2, 69
-  Playback button ..... 30
-  Playback mode ..... 30
-  Playback zoom ..... 65
-  Scene mode ..... 35
-  Self-timer ..... 50
-  Setup menu ..... 76,  62
-  Smart portrait mode ..... 44
-  Special effects mode ..... 42
- T** (Telephoto) ..... 27
-  Thumbnail playback ..... 66
- W** (Wide-angle) ..... 27
-  Shooting mode button... 2, 24
- .JPG .....  99
- .MOV .....  99
- .WAV .....  99

## A

- AC adapter ..... 92,  101

- Action button ..... 2, 4
- Action control ..... 4
- Action control response  
..... 77,  71
- AF area mode  
..... 56, 73,  38,  58
- AF-assist illuminator  
..... 1, 76,  69
- A-GPS File ..... 87,  79
- Album .....  5
- Altimeter ..... 86
- Altitude log ..... 88
- Altitude/depth options  
..... 88,  91
- Aperture value ..... 29
- Atmospheric pressure ..... 86
- Auto flash ..... 49
- Autofocus  
..... 56, 73,  41,  59
- Auto mode ..... 24, 45
- Auto off ..... 23, 77,  72
- Auto sort mode .....  9
- Auto with red-eye reduction ..... 49

## B

- Backlighting  ..... 35, 38
- Battery ..... 12, 14, 20
- Battery charger ..... 15,  101
- Battery latch ..... 12
- Battery level indicator ..... 22
- Battery-chamber/memory card slot  
cover ..... 12, 16
- Beach  ..... 35
- Best Shot Selector ..... 38,  35
- Black and white copy  ..... 35, 38

Refer to the *Reference Manual* for pages indicated with .

- Blink proof..... 57, 44
- Blink warning..... 77, 76
- Brightness..... 76, 65
- BSS..... 38, 35
- Button sound..... 70
- ## C
- Calculate distance ..... 87, 81
- Calendar display ..... 66
- Charge by computer .... 77, 75
- Charge lamp..... 15
- Charger..... 15, 101
- Charging AC Adapter ..... 14
- Choose key picture  
..... 68, 11, 53
- Close-up ..... 35, 37
- Compression ratio ..... 30
- Computer..... 93, 95
- Continuous..... 56, 34
- Copying images..... 67, 52
- Create log ..... 88, 83
- Crop..... 20
- Cross process ..... 42
- ## D
- Data imprint ..... 67, 18
- Date and time ..... 18, 76, 63
- Date format..... 19, 63
- Daylight saving time  
..... 19, 20, 63
- Delete..... 31, 75, 12, 51
- Depth gauge..... 86
- Depth log..... 88
- Digital zoom..... 27, 76, 70
- Direct print..... 93, 22
- Displaying maps ..... 82
- Distance units..... 87, 80
- D-Lighting ..... 67, 15
- DPOF print ..... 27
- DSCN ..... 99
- Dusk/dawn ..... 35
- ## E
- Easy panorama ... 35, 39, 2
- Easy panorama playback  
..... 39, 4
- Electronic compass ..... 88, 89
- Exposure compensation..... 52
- Extension ..... 99
- Eye-Fi upload ..... 77, 77
- Eyelet for camera strap ..... 1, 2
- ## E
- Face detection ..... 62
- Face priority  
..... 62, 73, 38, 58
- Favorite pictures ..... 68, 5
- Favorite pictures mode..... 5
- File name ..... 99
- Fill flash ..... 49
- Fireworks show ..... 35, 38
- Firmware version ..... 77, 78
- Fixed range auto..... 37
- Flash..... 1, 48
- Flash lamp..... 2, 48
- Flash mode..... 48, 49
- Flash off ..... 49
- Focus  
..... 28, 56, 73, 38, 58
- Focus area ..... 28
- Focus indicator ..... 9
- Focus lock ..... 64
- Food ..... 35, 37
- Format internal memory  
..... 77, 73

Format memory cards .....	17, 77,	73	
Formatting .....	17, 77,	73	
Frame rate .....	73,	61	
FSCN .....		99	
Full-frame playback .....		65	
Full-time AF .....	73,	41,	59
<b>G</b>			
Glamour retouch .....	67,	17	
<b>H</b>			
HDMI .....		74	
HDMI cable .....	93,	21	
HDMI connector cover .....		1	
HDMI device control .....		74	
HDR .....		38	
Help .....		35	
High key		42	
High-contrast monochrome		42	
High-speed continuous .....		34	
HS movie .....	73,	55,	56
<b>I</b>			
Identifier .....		99	
Image copy .....	67,	52	
Image mode .....	56,	30	
Image review .....	76,	65	
Image size .....	56,	30	
Imprinting date and time .....	20, 76,	67	
Internal memory .....	17, 22		
Internal memory indicator .....	9, 11		
ISO sensitivity .....	56,	37	
<b>L</b>			
Landscape		35	
Language .....	77,	74	
Lens .....	1,	7,	26
List by date mode .....		10	
Location data options .....		87	
Low key		42	
<b>M</b>			
Macro mode .....		51	
Map actions .....	77,	72	
Map display .....		82	
Memory capacity .....		22	
Memory card .....		16	
Memory card slot .....		16	
Microphone .....		1	
Micro-USB connector .....	92, 95,	23	
Monitor .....	8,	7	
Monitor settings .....	76,	65	
Motion detection .....	76,	69	
Movie editing .....	75,	28	
Movie length .....	69, 70		
Movie light .....	73,	60	
Movie menu .....	73,	54	
Movie options .....	73,	54	
Movie playback .....		74	
Movie recording .....		69	
Movie VR .....	73,	60	
Multi selector .....	6, 30, 47		
Multi-shot 16 .....		35	
Museum		35, 38	
<b>N</b>			
Night landscape		35, 37	
Night portrait		35, 36	
Nikon Transfer 2 .....		95	
Nostalgic sepia <b>SE</b> .....		42	
Number of exposures remaining .....	22,	31	

Refer to the *Reference Manual* for pages indicated with .

**Q**

- Open with HS footage ..... 73, 56, 58
- Optical zoom ..... 27
- Optional accessories ..... 101

**P**

- Paper size ..... 25, 26
- Party/indoor ..... 35, 36
- Pet portrait auto release ..... 40
- Pet portrait ..... 35, 40
- Photo info ..... 76, 65
- Photo VR ..... 76, 68
- PictBridge ..... 93, 22
- Playback ..... 30, 65, 74, 51
- Playback action control ..... 77, 71
- Playback menu ..... 67, 45
- Playback mode ..... 30
- Playback zoom ..... 65
- Points of interest.... 80, 88, 82
- Pop **POP** ..... 42
- Portrait ..... 35
- Power ..... 22
- Power switch ..... 1, 22
- Power-on lamp ..... 1
- Preset manual ..... 33
- Pre-shooting cache ..... 34, 36
- Pressing halfway ..... 29
- Print ..... 67, 93, 24, 26, 45
- Print date ..... 20, 76, 67
- Print order ..... 67, 45
- Print order date option ..... 20, 46, 67
- Printer ..... 93, 22

- Protect ..... 67, 49

**Q**

- Quick effects ..... 30, 46, 56, 14, 41
- Quick retouch ..... 67, 15

**R**

- Recording movies ..... 69
- Recording slow motion movies ..... 73, 55, 56
- Red-eye correction ..... 67, 16
- Remove from favorites.... 68, 7
- Reset all ..... 77, 78
- Rotate image ..... 67, 50
- RSCN ..... 99

**S**

- Scene mode ..... 35, 36
- Selective color ..... 42
- Self-timer ..... 50
- Self-timer lamp ..... 1, 50
- Sequence display options ..... 68, 11, 53
- Set clock from satellite . 88, 88
- Setup menu ..... 76, 62
- Shooting ..... 24, 26, 28
- Shooting menu ..... 55, 30
- Shooting mode ..... 24
- Shutter sound ..... 70
- Shutter speed ..... 29
- Shutter-release button ..... 28
- Single ..... 56, 34
- Single AF ..... 73, 41, 59
- Skin softening ..... 57, 63, 42
- Slide show ..... 67, 48
- Slow sync ..... 49
- Small picture ..... 67, 19

Smart portrait menu.....	55,	42	Volume.....	74,	51
Smart portrait mode .....		44	<b>W</b>		
Smile timer .....	57,	43	Welcome screen .....	76,	62
Snow		35	White balance.....	56,	32
Soft <b>SO</b> .....		42	Wi-Fi options .....	90,	92
Sound settings.....	76,	70	Wind noise reduction ...	73,	61
Speaker .....		2	Wireless LAN.....	89,	92
Special effects mode.....		42	<b>Z</b>		
Sports		35, 36	Zoom.....		27
SSCN.....		99	Zoom control.....		27
Strap for land use.....		3			
Subject tracking.....		39,			
Sunset		35			
Super vivid <b>VI</b> .....		42			

## I

Target finding AF....	56, 61,	39
Thumbnail playback.....		66
Time difference .....		64
Time zone .....	20,	63
Time zone and date .....	18, 76,	63
Toy camera effect 1		42
Toy camera effect 2		42
Tripod socket.....	2,	29
TV .....	93,	21
TV settings.....	77,	74

## U

Underwater		35, 41
USB cable .....	92, 95,	23

## V

Vibration reduction .....	73, 76,	60,	68
View log.....	88,	86	
ViewNX 2.....		94	
Voice memo.....	67,	51	

Refer to the *Reference Manual* for pages indicated with .



A series of horizontal dashed lines spanning the width of the page, intended for handwriting practice.

No reproduction in any form of this manual, in whole or in part (except for brief quotation in critical articles or reviews), may be made without written authorization from NIKON CORPORATION.

