

Nikon

Autofocus Speedlight

SB-700

User's Manual



Nikon Manual Viewer 2

Install the Nikon Manual Viewer 2 app on your smartphone or tablet to view Nikon digital camera manuals, anytime, anywhere. Nikon Manual Viewer 2 can be downloaded free of charge from the App Store and Google Play.

En

About the SB-700 and This User's Manual

Thank you for purchasing the Nikon Speedlight SB-700. To get the most out of your Speedlight, please read this user's manual thoroughly before use.

How to find what you are looking for

🔍 **Table of contents** (📖A-11)

You can search by item, such as operation method, flash mode or function.

🔍 **Q&A index** (📖A-9)

You can search according to objective without knowing the specific name or term of an item.

🔍 **Index** (📖H-28)

You can search using the alphabetical index.

🔍 **Troubleshooting** (📖H-1)

This is handy when there is a problem with your Speedlight.

For your safety

Before using the Speedlight for the first time, read the safety instructions in "For Your Safety" (📖A-14 – A-22).

Included items

Check that all items listed below are included with the SB-700. If any items are missing, inform the store where the SB-700 was purchased or the seller immediately.

- Speedlight Stand AS-22
- Nikon Diffusion Dome SW-14H
- Incandescent Filter SZ-3TN
- Fluorescent Filter SZ-3FL
- Soft Case SS-700
- User's manual (this manual)
- A collection of example photos
- Warranty card

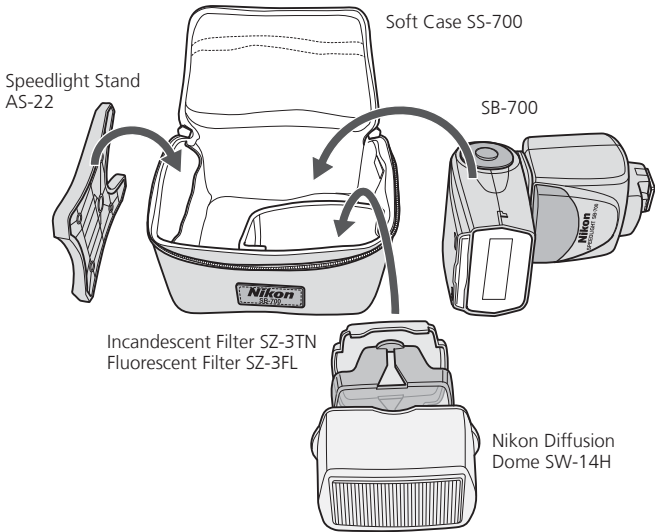

About the SB-700 and This User's Manual

A

Preparation

About the SB-700

The SB-700 is a high-performance Speedlight compatible with Nikon Creative Lighting System (CLS) with a guide number of 28/39 (ISO 100/200, m) (92/128, ft) (at the 35 mm zoom head position in Nikon FX format with standard illumination pattern, 20 °C/68 °F).

CLS-compatible cameras

Nikon digital SLR (Nikon FX/DX format) cameras (except D1 series and D100), F6, COOLPIX cameras (A, P7800, P7700, P7100, P7000, P6000)

About this user's manual

This manual has been compiled with the assumption that the SB-700 will be used in combination with a camera compatible with CLS and a CPU lens (□A-5). To get the most out of your Speedlight, please read this user's manual thoroughly before use.

- For use with non-CLS-compatible SLR cameras, see "For Use with Non-CLS-compatible SLR Cameras." (□F-1)
- For use with i-TTL-compatible COOLPIX cameras (P5100, P5000, E8800, E8700, E8400), see "For Use with COOLPIX Cameras." (□G-1)
- The separate "A collection of example photos" provides an overview of the SB-700's flash photography capabilities with example photos.
- For camera functions and settings, see the camera user's manual.

Icons used in this manual

- ✓ Describes a point to which you should pay particular attention in order to avoid Speedlight malfunctions or mistakes.
- ✍ Includes information or tips to make Speedlight use easier.
- 📖 Reference to other pages in this manual

✍ Tips on identifying CPU NIKKOR lenses

CPU lenses have CPU contacts.

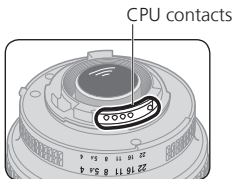

- The SB-700 cannot be used with IX-Nikkor lenses.

Terminology

Default settings: function and mode settings at the time of purchase

Nikon Creative Lighting System (CLS): a lighting system that enables various flash photography functions with improved communication between Nikon Speedlights and cameras

Illumination patterns: control types of light falloff at edges; the SB-700 provides three illumination patterns, standard, center-weighted and even.

FX format/DX format: Nikon digital SLR camera image area types (FX format: 36×24 , DX format: 24×16)

Guide number (GN): the amount of light generated by a flash unit; $GN = \text{flash-to-subject distance (m or ft)} \times \text{f-number of aperture (ISO 100)}$

Zoom head position: position of a Speedlight zoom head; the angle of coverage changes as the zoom head position changes.

Effective flash output distance: flash-to-subject distance with correctly adjusted flash output

Effective flash output distance range: range of effective flash output distance

Flash compensation: intentional flash output change to obtain the desired subject brightness

i-TTL mode: flash mode in which the SB-700 fires monitor pre-flashes and the camera measures the reflected light and controls the SB-700 flash output

Monitor pre-flashes: scarcely visible flashes emitted before actual firing that enable the camera to measure the light reflected on a subject

i-TTL balanced fill-flash: i-TTL mode type in which flash output level is adjusted to well-balanced exposure of the main subject and background

Standard i-TTL: i-TTL mode type in which flash output level is adjusted to the correct exposure of the main subject regardless of background brightness

Manual flash mode: flash mode in which the flash output level and aperture are manually set to obtain the desired exposure

Distance-priority manual flash mode: manual flash mode with distance priority; the flash-to-subject distance is set and the Speedlight flash output level is adjusted in accordance with the camera settings.

Step: a unit of the shutter speed or aperture change; a change of one step halves/doubles the amount of light entering the camera

EV (Exposure Value): each increment of 1 in exposure value corresponds to a one-step change in exposure, which is made by halving/doubling shutter speed or aperture

About the SB-700 and This User's Manual

A

Preparation

Wireless multiple flash-unit photography: flash photography with multiple wireless flash units simultaneously firing

Master flash unit: the flash unit that commands remote flash units in multiple flash-unit photography

Remote flash unit: a flash unit that fires following commands from the master flash unit

Advanced Wireless Lighting: wireless multiple flash-unit photography with CLS; multiple remote flash unit groups can be controlled with the master flash unit.

Quick wireless control mode: mode for multiple flash-unit photography with Advanced Wireless Lighting in which the flash output level ratios of two remote flash unit groups (A and B) can be easily balanced

SU-4 type wireless multiple flash-unit photography: wireless multiple flash-unit photography suited to taking picture of a fast-moving subject

Q&A Index

You can search for specific explanations according to objective.

Flash photography 1 (with SB-700 mounted on camera)

Question	Key phrase	□
Which flash mode can I take pictures with?	Flash modes	C-1
How can I take pictures in the simplest way?	Basic operation	B-7
How can I take portrait photos emphasizing the main subject?	Illumination pattern: Center-weighted	E-3
How can I take formal group shots?	Illumination pattern: Even	E-3
How can I take pictures with soft shadows cast on a wall?	Bounce flash operation	E-5
How can I confirm lighting conditions?	Modeling illumination	E-29
How can I take brighter (or darker) pictures of the subject?	Flash compensation	E-23
How can I take pictures under fluorescent light and incandescent light and balance the lights' color effects?	Color compensation filters	E-17
How can I take pictures adding specific color to the light of Speedlight?	Color filters	E-19

A**B****C****D****E****F****G****H**

Question	Key phrase	☰
How can I use autofocus in dim lighting?	AF-assist illumination	E-27
How can I take pictures of both the subject and background at night?	Slow sync	E-33
How can I take pictures without the subject's eyes appearing red?	Red-eye reduction	E-34
How can I use the SB-700 with a non-CLS-compatible SLR camera?	Non-CLS-compatible SLR camera	F-1
How can I use the SB-700 with a COOLPIX camera?	COOLPIX camera	G-1

Flash photography 2 (with wireless SB-700)

Question	Key phrase	☰
How do I take pictures using multiple flash units?	Advanced Wireless Lighting	D-2 D-9
How do I take pictures in a quick and simple way with wireless multiple flash units?	Quick wireless control mode	D-13
How do I take pictures of a fast-moving subject using wireless multiple flash-unit photography?	SU-4 type wireless multiple flash-unit photography	D-3 D-18
How do I take pictures with the SB-700 and a COOLPIX camera compatible with wireless multiple flash-unit photography?	CLS-compatible COOLPIX camera	G-1

Table of Contents

A

Preparation

About the SB-700 and This User's Manual.....	A-2
Q&A Index.....	A-9
For Your Safety.....	A-14
Check before Use.....	A-23

B

Operation

Speedlight Parts.....	B-1
Basic Operations.....	B-7
Settings and the LCD.....	B-16
Custom Functions and Settings.....	B-17

C

Flash Modes

i-TTL Mode.....	C-1
Manual Flash Mode.....	C-6
Distance-priority Manual Flash Mode.....	C-11

D

Wireless Multiple Flash-unit Photography

SB-700 Wireless Multiple Flash-unit Photography Setup.....	D-1
SB-700 Wireless Multiple Flash-unit Functions.....	D-4
Setting the Master Flash Unit.....	D-6
Setting the Remote Flash Unit.....	D-8
Advanced Wireless Lighting Operation.....	D-9
Quick Wireless Control Mode.....	D-13
SU-4 Type Wireless Multiple Flash-unit Photography.....	D-18

A

Table of Contents

Remote Flash Units	D-23
Checking Status in Wireless Multiple Flash-unit Photography.....	D-27

Functions

Switching Illumination Patterns	E-2
Bounce Flash Operation	E-5
Taking Close-up Photographs.....	E-13
Flash Photography with Color Filters	E-17
Flash Photography Support Functions.....	E-23
• Flash compensation	E-23
• Power zoom function	E-25
• AF-assist illumination	E-27
• Test firing	E-29
• Modeling illumination.....	E-29
• Standby function	E-30
• Thermal cut-out.....	E-31
Functions to Be Set on the Camera	E-32
• Auto FP high-speed sync.....	E-32
• Flash value lock (FV lock)	E-33
• Slow sync	E-33
• Red-eye reduction/red-eye reduction slow sync.....	E-34
• Rear-curtain sync	E-34

F

For Use with Non-CLS-compatible SLR Cameras..... F-1

G

For Use with COOLPIX Cameras..... G-1

H

Tips on Speedlight Care and Reference Information

TroubleshootingH-1
Guide Number, Aperture and Flash-to-subject DistanceH-6
Tips on Speedlight CareH-7
Notes on Batteries.....H-9
About the LCD PanelH-11
Updating FirmwareH-12
Optional AccessoriesH-13
SpecificationsH-15
IndexH-28

For Your Safety

A

Preparation

Before using your product, please read the following safety precautions carefully and thoroughly to ensure correct and safe use and to help prevent damage to your Nikon product or injury to yourself or others. For quick reference by those who use the product, please keep these safety instructions near the product.

In this manual, safety instructions are indicated with these symbols:



WARNING

Disregarding instructions marked with this symbol could result in personal injury, or death and property damage.



CAUTION

Disregarding instructions marked with this symbol could result in property damage.



WARNINGS for Speedlights

- 1. If corrosive liquids seep from the batteries and get in your eyes, immediately wash your eyes with running water and consult with a doctor.** Your eyes could be seriously damaged if they are not treated quickly.
- 2. If corrosive liquids seep from the batteries and come in contact with your skin or clothes, wash immediately with running water.** Prolonged contact could injure your skin.
- 3. Never attempt to disassemble or repair the flash unit by yourself,** as this could result in you receiving an electric shock and could also cause the unit to malfunction; such malfunction could lead to personal injury.

4. **If the flash unit is dropped and damaged, do not touch any exposed interior metal parts.** Such parts, especially the Speedlight's capacitor and associated parts, could be in a high-charge state and if touched could cause an electric shock. Disconnect the power or remove the batteries and be sure that you do not touch any of the product's electrical components, and then bring the flash unit to your local Nikon dealer or authorized service center for repair.
5. **If you detect heat, smoke or notice a burning smell, immediately stop operation and remove the batteries** to prevent the unit from catching on fire or melting. Allow the flash unit to cool down so that you can safely touch it and remove the batteries. Then bring the unit to your local Nikon dealer or authorized service center for repair.
6. **The flash unit should never be submerged in liquid or exposed to rain, saltwater or moisture unless it is properly protected from the liquids and moisture. Underwater use requires a certified underwater housing.** If water or moisture gets inside the unit, this could cause the unit to catch on fire or cause an electric shock. In such instances you should immediately remove the batteries from the Speedlight and then bring the unit to your local Nikon dealer or authorized service center for repair.
Note: *electronic devices that are penetrated by water or moisture are often not economically repairable.*
7. **Do not use the unit in the presence of flammable or explosive gas.** If the flash unit is operated in areas where there is a flammable gas, including propane, gasoline and dust, it could cause an explosion or fire.

For Your Safety

Preparation

A

- 8. Do not fire the flash unit directly at the driver of a moving car**, as this could temporarily impair the driver's vision and cause an accident.
- 9. Do not fire the flash unit directly into the eyes of someone that is at close range**, as it could damage the retinas of their eyes. Never fire the flash unit closer than 1 meter from infants.
- 10. Do not fire the unit while the flash head is touching a person or object.** Such use can result in the person being burned, and/or their clothes igniting from the heat of the flash's firing.
- 11. Keep small accessories out of the reach of children** to avoid the possibility of the accessory being swallowed. If an accessory is accidentally swallowed, immediately consult with a doctor.
- 12. Use only the batteries specified in this user's manual.** Batteries other than those specified could leak corrosive liquids, explode or catch on fire or otherwise not perform satisfactorily.
- 13. Do not mix battery types, brands or old and new batteries**, as the batteries could leak corrosive liquids, explode or catch on fire. When using more than one battery in a product, always use identical batteries that were purchased at the same time.
- 14. Non-rechargeable batteries such as manganese, alkaline and lithium batteries should never be charged in a battery charger** because they could leak corrosive liquids, explode or catch on fire.

15. When using standard size (AA, AAA, C, D) or other common rechargeable batteries such as Ni-MH batteries, or when recharging them, be sure to use only the battery charger specified by the battery maker and read the instructions thoroughly. **Do not recharge these batteries with their terminals reversed in the charger or before the batteries have cooled off sufficiently** because they could leak corrosive liquids, explode or catch on fire. The same caution also applies to using the rechargeable batteries that may be supplied by the photo product's manufacturer.

For Your Safety

A

Preparation



CAUTIONS for Speedlights

1. **Do not touch the flash unit with wet hands**, as this could cause an electric shock.
2. **Keep the flash unit away from children to prevent them from putting the unit in or near their mouth, or otherwise touching a dangerous part of the product;** as such contact could cause an electric shock.
3. **Do not apply strong physical shocks to the unit**, as this could cause a malfunction that could cause the unit to explode or catch on fire.
4. **Never use active agents that contain flammable substances such as paint thinner, benzene or paint remover to clean the unit, never use insect deterrent spray on the unit, and never store the unit in locations containing chemicals such as camphor and naphthalene**, as this could damage the plastic case, cause a fire or cause an electric shock.
5. **Remove any batteries from the unit before storing the unit for a long time** to prevent the unit from catching on fire or leaking corrosive liquids.



WARNINGS for Batteries

1. **Never heat or throw batteries into a fire**, as this could cause the batteries to leak corrosive liquids, generate heat or explode.
2. **Do not short-circuit or disassemble the batteries** because this could cause the batteries to leak corrosive liquids, generate heat or explode.
3. **Do not mix battery types, brands or old and new batteries**, as this could cause the batteries to leak corrosive liquids, generate heat or explode.
4. **Do not install batteries in the reverse direction as this could cause the batteries to leak corrosive liquids, generate heat or explode. Even if only one battery is installed in reverse it will cause the Speedlight to malfunction.**
5. **Be sure to use the battery charger specified by the battery maker** to avoid the possibility of batteries leaking corrosive liquids, generating heat or exploding.
6. **Do not carry or store batteries along with metallic materials such as necklaces and hair pins** because such materials could cause the batteries to short-circuit, leading to battery leakage, heat generation or an explosion. **In addition, especially when carrying a quantity of batteries, place them carefully in a storage case that prevents the battery terminals from touching another battery's terminals** because if they touch in reverse order it could also cause the batteries to short-circuit, leading to battery leakage, heat generation or an explosion.
7. **If corrosive liquids seep from the batteries and get in your eyes, immediately wash your eyes with running water and consult with a doctor.** Your eyes could be seriously damaged if they are not treated quickly.

For Your Safety

A

Preparation

- 8. If corrosive liquids seep from the batteries and come in contact with your skin or clothes, wash immediately with running water.** Prolonged contact could injure your skin.
- 9. Always follow the warnings and instructions printed on the batteries** to avoid activities that could cause the batteries to leak corrosive liquids, generate heat or catch on fire.
- 10. Be sure to use only batteries specified in this user's manual,** to avoid the possibility of batteries leaking corrosive liquids, generating heat or exploding.
- 11. Never open the casing surrounding batteries or use batteries whose casing has been breached** as such batteries could leak corrosive liquids, generate heat or explode.
- 12. Keep batteries out of the reach of children** to help avoid the possibility of them being swallowed. If a battery is accidentally swallowed, immediately consult with a doctor.
- 13. Batteries should not be submerged in water, exposed to rain, moisture or saltwater unless they are properly protected from the wet environment.** If water or moisture gets inside the batteries, this could cause them to leak corrosive liquids or generate heat.
- 14. Do not use any battery that appears abnormal in any way, including a change in color or shape.** Such batteries could leak corrosive liquids or generate heat.
- 15. Stop recharging rechargeable batteries if you notice that recharging is not completed within the specified time** to help prevent the possibility of the battery leaking corrosive liquids or generating heat.

16. **When recycling or disposing of batteries, be sure to insulate their terminals with tape.** If the battery's positive and negative terminals short-circuit after coming into contact with metallic objects, it could cause fire, heat generation or an explosion. Dispose of used batteries in accordance with local government regulations.
17. **Non-rechargeable batteries should never be charged in a battery charger** because they could leak corrosive liquids or generate heat.
18. **Remove dead batteries from your equipment immediately,** as they could leak corrosive liquids, generate heat or explode.
19. **Be careful when replacing batteries after continuous flash use,** because batteries may generate heat during continuous flash photography.

For Your Safety

CAUTION for Batteries

Do not throw or apply strong physical shocks to the batteries as this could cause batteries to leak corrosive liquids, generate heat or explode.

Preparation

Notice for customers in Europe



This symbol indicates that electrical and electronic equipment is to be collected separately.

The following apply only to users in European countries:

- This product is designated for separate collection at an appropriate collection point. Do not dispose of as household waste.
- Separate collection and recycling helps conserve natural resources and prevent negative consequences for human health and the environment that might result from incorrect disposal.
- For more information, contact the retailer or the local authorities in charge of waste management.

Check before Use

Tips on using the Speedlight

Take trial shots

Take trial shots before photographing important occasions such as weddings or graduations.

Have Nikon spot-check your Speedlight regularly

Nikon recommends that you have your Speedlight serviced by an authorized dealer or service center at least once every two years.

Use your Speedlight with Nikon equipment

The Nikon Speedlight SB-700's performance has been optimized for use with Nikon brand cameras/accessories including lenses. Cameras/accessories made by other manufacturers may not meet Nikon's criteria for specifications, and incompatible cameras/accessories could damage the SB-700's components. Nikon cannot guarantee the SB-700's performance when used with non-Nikon products.

Life-long learning

As part of Nikon's "life-long learning" commitment to ongoing product support and education, continually updated information is available online at the following websites:

- For users in the United States:
<http://www.nikonusa.com/>
- For users in Europe and Africa:
<http://www.europe-nikon.com/support/>
- For users in Asia, Oceania and the Middle East:
<http://www.nikon-asia.com/>

Visit these sites to keep up to date with the latest product information, tips, answers to frequently-asked questions (FAQs), and general advice on digital imaging and photography. Additional information may be available from the Nikon representative in your area. See the URL below for contact information:

<http://imaging.nikon.com/>

B Operation

Speedlight Parts

B

Operation

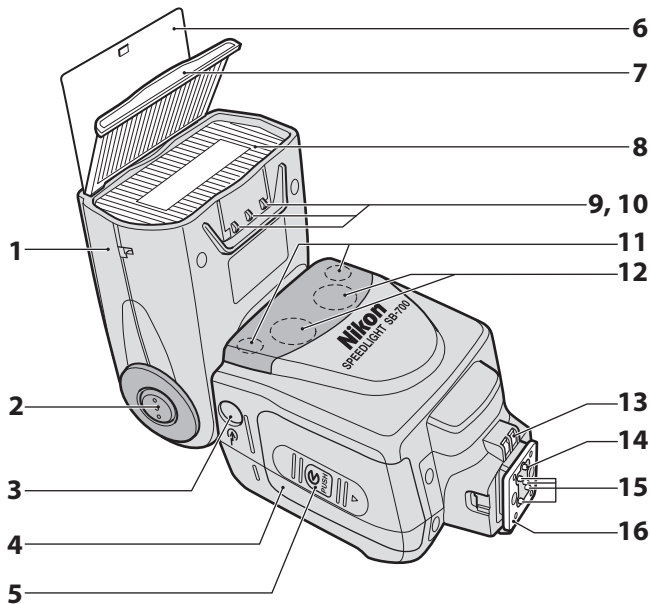

1. Flash head
2. Flash head tilting/rotating lock release button (☞E-6)
3. Light sensor window for wireless remote flash (☞D-23)
4. Battery chamber cover
5. Battery chamber cover lock release (☞B-8)
6. Built-in bounce card (☞E-12)
7. Built-in wide panel (☞E-14)
8. Flash panel
9. Filter detector
10. Nikon Diffusion Dome detector
11. Flash-ready indicator (in remote mode) (☞D-27)
12. AF-assist illuminator (☞E-27)
13. External AF-assist illuminator contacts (☞H-14)
14. Locking pin
15. Accessory shoe contacts
16. Mounting foot

Speedlight Parts

B

Operation

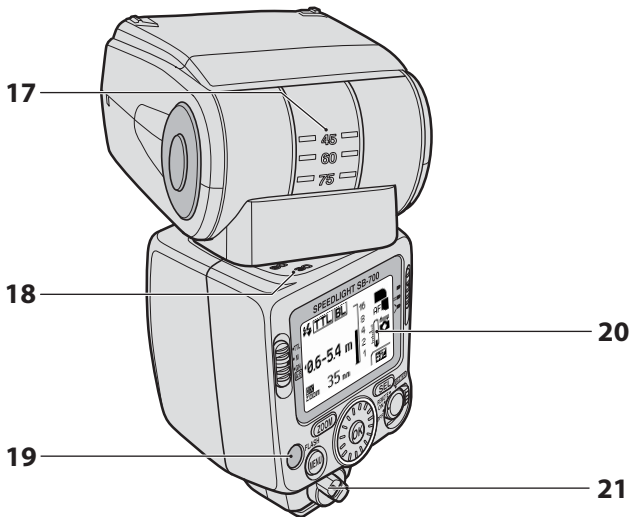

17. Flash head tilting angle scale (☞E-6)
18. Flash head rotating angle scale (☞E-6)
19. Flash-ready indicator (☞B-15, D-27)
20. LCD panel (☞B-16, H-11)
21. Mounting foot lock lever (☞B-11)

Speedlight Parts

B

Operation

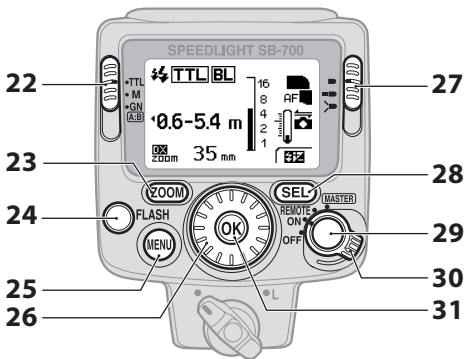

- 22. Mode selector**
Selects flash mode.
- 23. [ZOOM] button**
Press to adjust zoom head position. (☐E-26)
- 24. Test firing button**
Controls test firing. (☐E-29)
- 25. [MENU] button**
Displays custom settings. (☐B-18)
- 26. Selector dial**
Rotate to change selected item. The selected item is highlighted on the LCD. (☐B-16)
- 27. Illumination pattern selector**
Selects illumination pattern. (☐E-2)
- 28. [SEL] button (select button)**
Selects item to be configured. (☐B-16)
- 29. Lock release**
To select master or remote mode in wireless multiple flash-unit photography, rotate the power switch/wireless mode switch for multiple flash units while holding down the lock release in the center of the switch. (☐D-6, D-8)
- 30. Power switch/wireless mode switch for multiple flash units**
- Rotate to turn power on and off.
 - Selects the master or remote mode in wireless multiple flash-unit photography. (☐D-6, D-8)
- 31. [OK] button**
Confirms selected setting. (☐B-16)

Basic Operations

This section covers basic procedures in i-TTL mode in combination with a CLS-compatible camera.

Notes on continuous flash photography

- To prevent the SB-700 from overheating, allow it to cool down for at least 10 minutes after 15 times of continuous firing.
- When continuous flash firing is repeated in quick succession, the internal safety function adjusts the recycling time by up to 15 seconds. If flash firing continues, the thermal cut-out indicator appears on the LCD and all operations are suspended. (E-31) Allow it to cool down for several minutes to disable this function.
- The conditions under which the internal safety function is activated differ depending on the temperature and the SB-700 flash output level.

STEP 1 Inserting the batteries

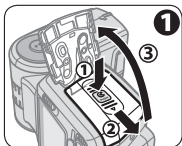

1 Slide the battery chamber cover open while pressing the battery chamber cover lock release.

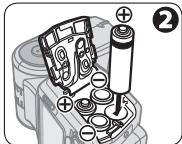

2 Insert the batteries following the [+] and [-] marks.

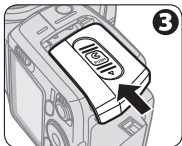

3 Close the battery chamber cover.

Basic Operations

Suitable batteries

When replacing batteries, use four fresh AA-type batteries of the same brand from any of the following types:

B

Operation

1.5 V alkaline AA battery

1.5 V lithium AA battery

Rechargeable 1.2 V Ni-MH AA battery

- For minimum recycling time and number of flashes for each battery type, refer to “Specifications.” (□H-27)
- Alkaline battery performance may vary greatly depending on the manufacturer.
- 1.5 V carbon-zinc AA batteries are not recommended.

Additional precautions regarding batteries

- Read and follow battery warnings and cautions (□A-19 – A-22).
- Be sure to read and follow the warnings for the battery on the section, “Notes on Batteries” (□H-9), before using the battery.
- The recycling time can be longer when lithium AA batteries are used because they incorporate a function that suppresses the output current when heat is generated in the batteries.

■ Replacing/recharging batteries

Refer to the following table to determine when to replace batteries with fresh ones or recharge batteries according to how long the flash-ready indicator takes to come on.

1.5 V alkaline AA battery	10 seconds or more
1.5 V lithium AA battery	10 seconds or more
Rechargeable 1.2 V Ni-MH AA battery	10 seconds or more

■ Low battery power indicator



When battery power is low, the icon shown at the left appears on the LCD and the SB-700 stops functioning. Replace or recharge batteries.

STEP 2 Attaching the SB-700 to the camera

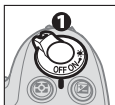

- 1 Make sure the SB-700 and the camera body are turned off.

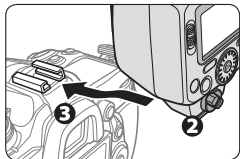

- 2 Make sure the mounting foot lock lever is on the left (white dot).

- 3 Slide the SB-700's mounting foot into the camera's accessory shoe.

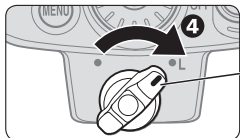

- 4 Turn the lock lever to "L."

Lock the Speedlight in place

Turn the lock lever clockwise until it stops at the mounting foot lock index.

■ Detaching the SB-700 from the camera

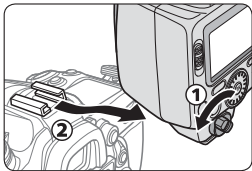

- 1 Make sure the SB-700 and the camera body are turned off, turn the lock lever 90° to the left, and then slide the SB-700's mounting foot from the camera's accessory shoe.

- If the SB-700's mounting foot cannot be removed from the camera's accessory shoe, turn the lock lever 90° to the left again, and slide the SB-700 slowly out.
- Do not forcibly remove the SB-700.

STEP 3 Adjusting the flash head

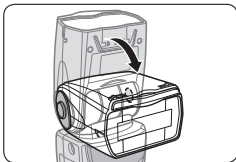

① Adjust the flash head to the front position.

- The flash head is locked at front.

LCD indicator for flash head status

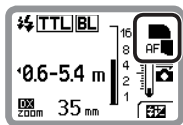

Flash head is set at front.



Flash head is set at angle other than front. (Flash head is tilted up or rotated to the right or left.)



Flash head is tilted down.

STEP 4 Turning the SB-700 and camera on



- 1 Turn the SB-700 and the camera body on.

B

Operation

LCD sample

- The image below is the SB-700 LCD sample under the following conditions: flash mode: i-TTL mode; image area: DX format; illumination pattern: standard; ISO sensitivity: 100; zoom head position: 35 mm; f-number of aperture: 5.6
- Icons on the LCD may differ depending on the SB-700 settings and the camera and lens in use.

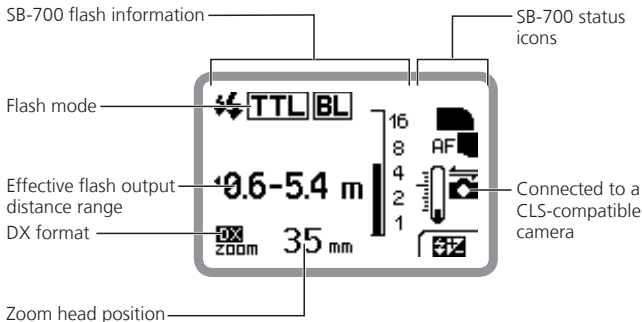

STEP 5 Selecting the flash mode

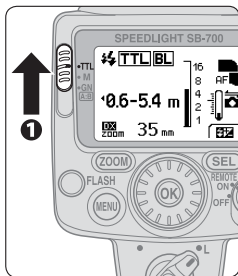

- 1 Set the mode selector to [TTL].

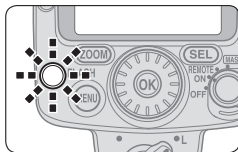

- 2 Make sure that the flash-ready indicator on the SB-700 or in the camera's viewfinder is on before taking a picture.



Settings and the LCD

Icons on the LCD show the status of settings. Displayed icons vary according to selected flash modes and settings.

- Configurable settings are highlighted when the [SEL] button is pressed.
- Highlighted settings can be changed with the selector dial.
- The basic control of SB-700 functions is as follows:

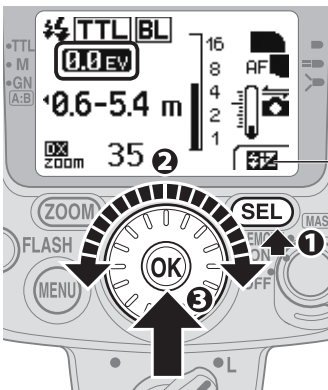

- If there is a configurable setting, an icon indicating the setting appears in the bottom right corner. If there are two or more configurable settings, the SEL icon is displayed, indicating configurable items can be selected with the [SEL] button.

- 1 Press the [SEL] button to highlight the selected item.**
- 2 Change the setting by rotating the selector dial.**
- 3 Press the [OK] button to confirm setting.**
 - Once confirmed, the highlighted item returns to normal display.
 - If the [OK] button is not pressed, the highlighted item is confirmed and returns to normal display after 8 seconds.

Custom Functions and Settings

Various operations for the SB-700 can be easily set using the LCD.

- Displayed icons vary according to the combination of camera and status of the SB-700.
- Functions and settings indicated with grid boxes do not function even though they can be configured and set.

B

Operation

Custom setting

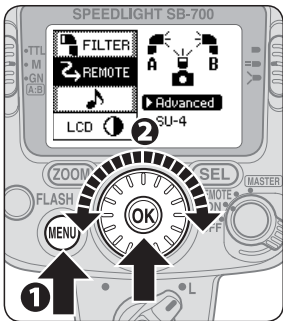

- 1 Press the [MENU] button to display the custom setting.
- 2 Rotate the selector dial to choose an item, and then press the [OK] button.
 - The highlighted item can be configured.

Custom settings

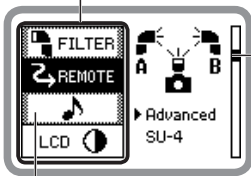

Position of highlighted item (within 11 items)
This is not displayed while a selected item is being configured.

Items indicated with grid boxes can be configured but do not effect flash operation.

Custom Functions and Settings

Operation

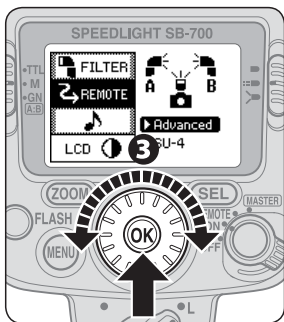

3 Rotate the selector dial to highlight the chosen setting, and then press the [OK] button.

- Highlighted while selected
- Press the [OK] button to return selection.

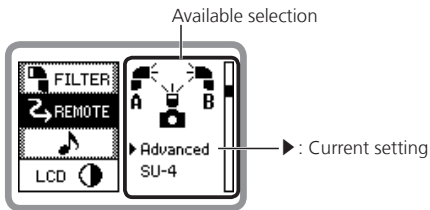



4 Press the [MENU] button to return to normal display.







- The LCD returns to normal display.







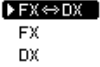

Available custom functions and settings

(**Bold:** default)

 FILTER	Color filters (☐E-20) The color of the filter in use can be set.
▶ RED BLUE YELLOW AMBER OTHER	RED BLUE YELLOW AMBER OTHER (Set when filter color is none of the above.)
 REMOTE	Remote flash unit setting (☐D-1, D-18)
▶ Advanced SU-4	Advanced: Advanced Wireless Lighting SU-4: SU-4 type wireless multiple flash-unit photography
	Sound monitor (☐D-27) When the SB-700 is used as a wireless remote flash unit, the sound monitor function can be activated or canceled.
▶ ON OFF	ON: Sound on OFF: Sound off

Custom Functions and Settings

	LCD panel contrast (☞H-11) Contrast levels are displayed on the LCD in a nine-step graph.
	5 levels in 9 steps
	Standby function (☞E-30) Adjusting the time before the standby function is activated.
	AUTO: Standby function activated when the camera's exposure meter is turned off 40: 40 seconds ---: Standby function canceled
	FX/DX format selection (☞A-6) When the zoom head position is manually set, image area settings can be selected.
	FX↔DX: Automatically set according to the camera's image area FX: Nikon FX format (36 × 24) DX: Nikon DX format (24 × 16)
	Flash compensation step in manual flash mode (☞C-9) Setting flash compensation step between M1/1 and M1/2 in manual flash mode
	1/3 EV: Compensation with 1/3 EV step 1 EV: Compensation with 1 EV step

	Unit of measuring distance
	m: meters ft: feet
	AF-assist illumination (☞E-27)
	ON: Activate AF-assist illumination OFF: Cancel AF-assist illumination
	Version of firmware (☞H-12)
	
	Reset custom setting Reset custom setting except unit of measuring distance, color filters and version of firmware to default setting.
	YES: Reset to default NO: Do not reset

i-TTL Mode

Information obtained by monitor pre-flashes and exposure control information is integrated by the camera to automatically adjust flash output levels.

- To take pictures using the SB-700 set in i-TTL mode, see “Basic Operations” (□B-7).
- Either the i-TTL balanced fill-flash mode or the standard i-TTL mode option is available depending on the camera settings. The SB-700 does not have i-TTL mode type selection.

i-TTL balanced fill-flash

The flash output level is automatically adjusted for well-balanced exposure of the main subject and background. **TTL|BL** appears on the LCD.

Standard i-TTL

The main subject is correctly exposed regardless of background brightness. This is useful when you want to highlight the main subject. **TTL** appears on the LCD.

Camera's metering mode and i-TTL mode

- When the camera's metering mode is changed to spot metering while i-TTL balanced fill-flash is in use, the i-TTL mode automatically changes to the standard i-TTL mode.
- The i-TTL mode automatically changes to i-TTL balanced fill-flash, after changing the camera's metering mode to matrix or center-weighted.

i-TTL Mode

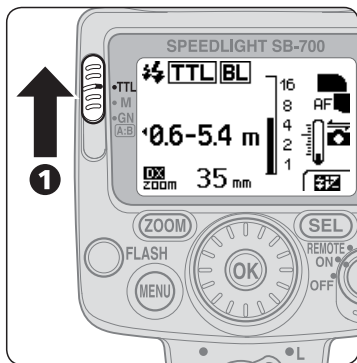

Setting i-TTL mode

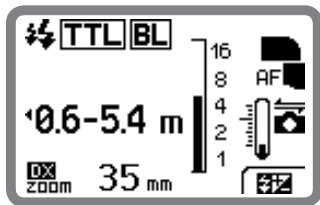

- 1 Set the mode selector to [TTL].

i-TTL mode LCD sample



-  : Monitor pre-flashes
-  : i-TTL
-  : Balanced fill-flash

SB-700 effective flash output distance range

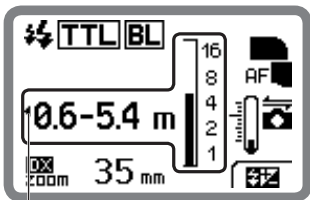

This icon means that the flash output cannot be effectively adjusted for a shorter distance.

The effective flash output distance range is indicated by numbers and a bar chart on the LCD.

- The actual flash-to-subject distance should be within the range displayed.
- The range varies depending on the camera's image area setting, illumination pattern, ISO sensitivity, zoom head position and aperture. For more information, see "Specifications." (□H-18)

Auto setting of ISO sensitivity, aperture and focal length

When using the SB-700 with a CLS-compatible camera and a CPU lens, ISO sensitivity, aperture and focal length are automatically set according to the lens and camera information.

- For more information about ISO sensitivity range, see the camera user's manual.

i-TTL Mode

When insufficient flash output for correct exposure is indicated

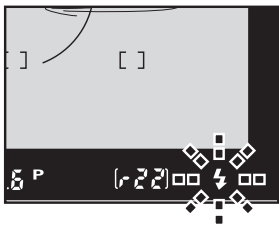
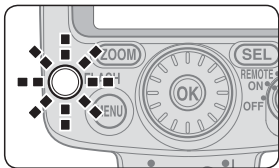

- When the flash-ready indicators on the SB-700 and in the camera's viewfinder blink for approx. 3 seconds after a picture is taken, underexposure due to insufficient flash output may have occurred.
- To compensate, use a wider aperture or higher ISO sensitivity, or move the flash unit closer to the subject and reshoot.
- Underexposure due to insufficient flash output is indicated by the exposure value (-0.3 EV to -3.0 EV) on the SB-700's LCD panel for approx. 3 seconds.

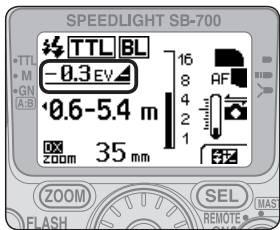

Manual Flash Mode

In manual flash mode, aperture and flash output level are manually selected. This allows for control of exposure and flash-to-subject distance.

- The flash output level can be set from M1/1 (full output) to M1/128 to suit creative preferences.
- Underexposure due to insufficient flash output is not indicated in manual flash mode.

Manual Flash Mode

Setting manual flash mode

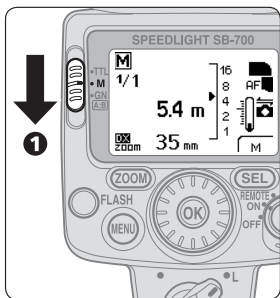

- 1 Set the mode selector to [M].

Manual flash mode LCD sample

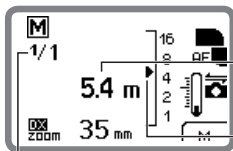

Effective flash output distance (numerical indicator)

Effective flash output distance (▶)

Flash output level

Taking a picture in manual flash mode

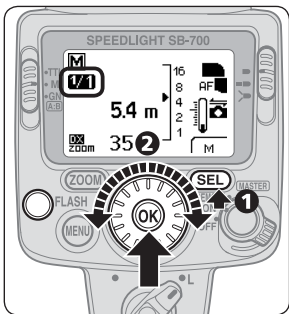

- 1 Press the [SEL] button to highlight the flash output level.
- 2 Set the flash output level by rotating the selector dial, and then press the [OK] button.
 - Flash output level can be set with the [SEL] button as well.
 - Make the flash-to-subject distance equal to the effective flash output distance indicated.
- 3 Confirm the flash-ready indicator is on, and then shoot.

Manual Flash Mode

■ Setting the flash output level

Highlight the flash output level, and then rotate the selector dial to change the flash output level.

Selector dial rotated
counterclockwise

Selector dial rotated
clockwise

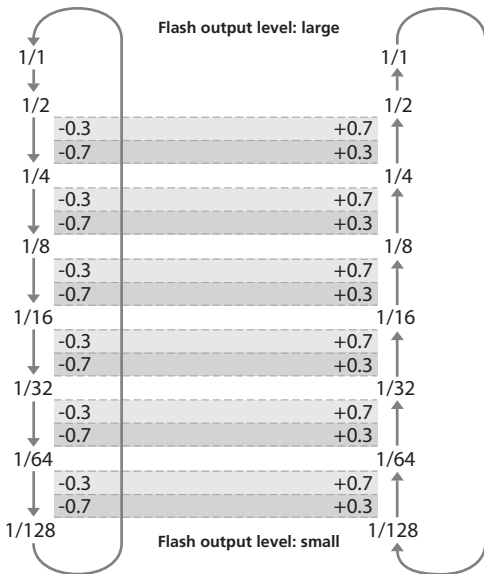

- When the selector dial is rotated counterclockwise, the indicated denominator increases (flash output level decreases). When the selector dial is rotated clockwise, the indicated denominator decreases (flash output level increases).
- The flash output level changes in $\pm 1/3$ EV steps except between 1/1 and 1/2. 1/32 -0.3 and 1/64 +0.7 represent the same flash output level.
- In default setting, the flash compensation step between 1/1 and 1/2 is ± 1 EV step. This step can be changed to $\pm 1/3$ EV steps using a custom setting (B-21). With some cameras, and when using faster shutter speeds with a flash output level higher than M1/2, actual flash output may decrease to M1/2 level.

Distance-priority Manual Flash Mode

In this flash mode, when the flash-to-subject distance value is entered, the SB-700 automatically controls flash output level according to the camera settings.

Setting distance-priority manual flash mode

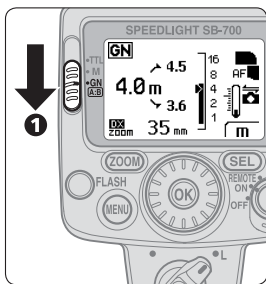

- 1 Set the mode selector to [GN].

Distance-priority manual flash mode LCD sample (at flash-to-subject distance of 4 m)

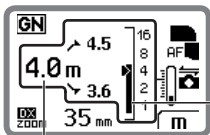

Flash-to-subject distance
(numerical indicator)

Flash-to-subject distance (▶) and effective flash output distance range indicator (bar)
When the flash-to-subject distance appears on the effective flash output distance range indicator, the SB-700 fires with appropriate flash output.

Distance-priority Manual Flash Mode

- Taking a picture in distance-priority manual flash mode

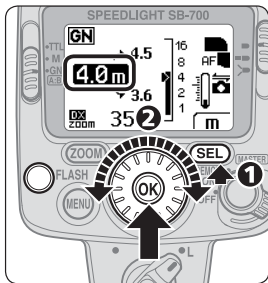

- 1 Press the [SEL] button to highlight flash-to-subject distance.
- 2 Set the flash-to-subject distance with the selector dial, and then press the [OK] button.

- The flash-to-subject distance can be set with the [SEL] button as well.
- The flash-to-subject distance varies depending on ISO sensitivity within a range of between 0.3 m and 20 m.
- When the flash-to-subject distance (▶) appears on the effective flash output distance range indicator (bar), the SB-700 fires with appropriate flash output.

- 3 Confirm the flash-ready indicator is on, and then shoot.

✓ When the bounce flash warning indicator is displayed

- Distance-priority manual flash is not possible when the SB-700's flash head is tilted up or rotated to the right or left.
- The below indicator appears.
- Set the flash head at front or tilt it down, or set the flash mode to i-TTL.



Flash-to-subject distance range in distance-priority manual flash mode

- Flash-to-subject distance range of between 0.3 m and 20 m
- If the desired flash-to-subject distance is not displayed, select a shorter flash-to-subject distance. E.g., if the flash-to-subject distance is 2.7 m, select 2.5 m.

Distance-priority Manual Flash Mode

✓ When insufficient flash output for correct exposure is indicated

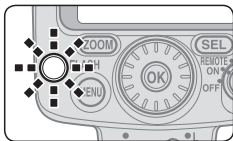

- When the flash-ready indicators on the SB-700 and in the camera's viewfinder blink for approx. 3 seconds after a picture is taken, underexposure due to insufficient flash output may have occurred.
- To compensate, use a wider aperture or higher ISO sensitivity and reshoot.

SB-700 Wireless Multiple Flash-unit Photography Setup

With the SB-700, “Advanced” and “SU-4” wireless flash operations are possible.

- With the SB-700’s default setting, flash photography with Advanced Wireless Lighting is possible. Advanced Wireless Lighting is recommended for standard multiple flash-unit photography.

SB-700 Wireless Multiple Flash-unit Photography Setup

Advanced Wireless Lighting

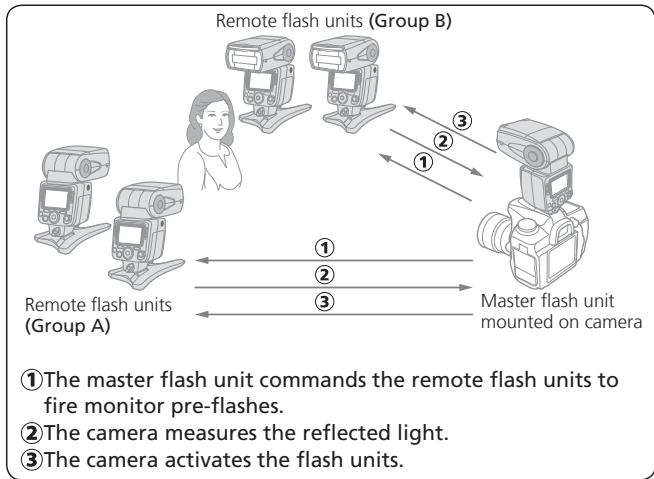

- The SB-700 mounted on a camera is the master flash unit.
- When the SB-700 is the master flash unit, up to two groups (A and B) of remote flash units can be set up.
- Single or several remote flash units can be allocated for one group.
- The remote flash unit flash mode is the same flash mode set on the master flash unit.

SU-4 type wireless multiple flash-unit photography

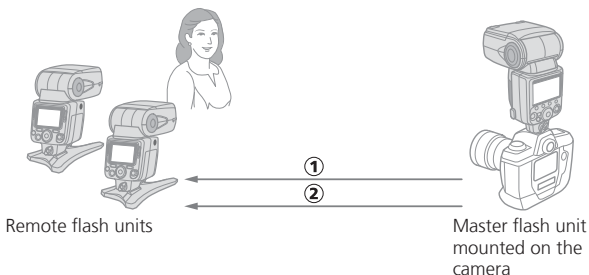

- ① Remote flash units start firing triggered by the master flash unit firing (in AUTO mode or M mode).
- ② Remote flash units stop firing when the master flash unit stops firing (in AUTO mode).

- The Speedlight mounted on the camera or the camera's built-in flash can be used as the master flash unit.
- The SB-700 can only be used as a remote flash unit.
- Be sure to cancel the master flash unit monitor pre-flash function or select a master flash unit flash mode that does not activate monitor pre-flashes.
- The flash mode is set on each flash unit. Set the same flash mode on each remote flash unit.

SB-700 Wireless Multiple Flash-unit Functions

		When used in master mode MASTER	When used in remote mode REMOTE
Flash photography with Advanced Wireless Lighting	Flash mode	<ul style="list-style-type: none"> • i-TTL TTL • Manual flash M • Quick wireless control A:B 	The SB-700 fires with the flash mode set on the master flash unit.
	Repeating flash photography* ¹	Not possible	Possible
	Group	2 groups (A and B)	Up to 3 groups (A, B, C)
	Channel* ²	4 channels (1 – 4)	4 channels (1 – 4)
SU-4 type wireless multiple flash-unit photography		Not possible	Possible (AUTO, M, OFF)

*1 See the master flash unit Speedlight (SB-910, SB-900, SB-800) or the Wireless Speedlight Commander (SU-800) user's manual for details of repeating flash photography.

*2 One of four channels can be used. Remote flash units can be triggered by other master flash units. Use a different channel number if another photographer is using the same type of wireless remote flash setup close by.

✓ Notes on canceling the flash of the master flash unit

When the master flash unit flash function is canceled and only the remote flash units fire, the master flash unit emits a number of weak light signals to trigger the remote flash units. This operation will normally not affect the correct exposure of the subject, although the exposure might be affected if the subject is close and a high ISO sensitivity has been set. To limit this effect, bounce the light by tilting up the master flash unit's flash head.

Setting the Master Flash Unit

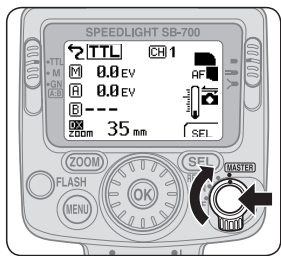

❶ Set the power switch/
wireless mode switch for
multiple flash units to
[MASTER].

- Turn the switch while holding
down the lock release in the
center.

Master mode LCD sample (i-TTL mode)

Master mode

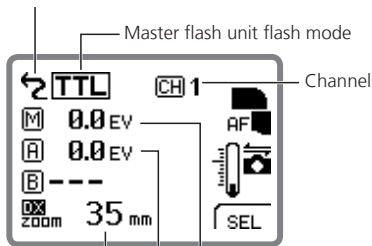

Master flash unit flash mode

Channel

Master flash unit flash compensation value

Remote flash unit flash compensation value

Master flash unit zoom head position

Master mode LCD sample (manual flash mode)

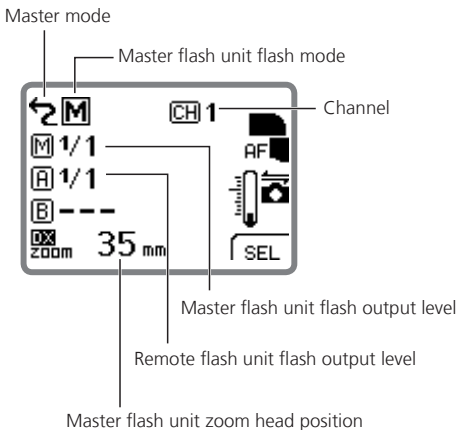

Setting the Remote Flash Unit

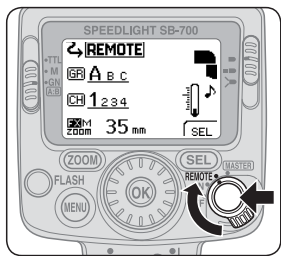

① Set the power switch/
wireless mode switch for
multiple flash units to
[REMOTE].

- Turn the switch while holding
down the lock release in the
center.

Remote mode LCD sample (Advanced Wireless Lighting)

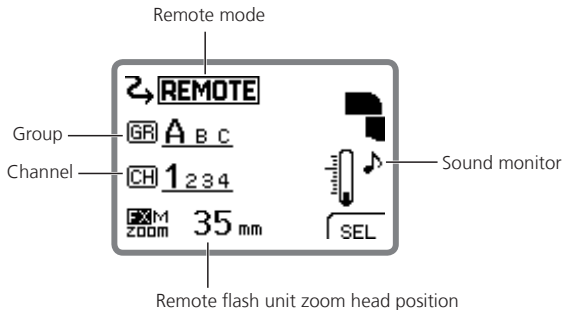

Advanced Wireless Lighting Operation

Taking a picture with Advanced Wireless Lighting

1. Master flash unit setting (flash mode, flash compensation value and channel)

[Setting i-TTL mode and channel 1 (example)]

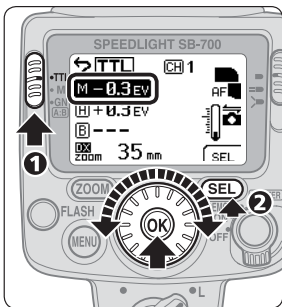

1 Set the mode selector to [TTL].

- In order to set the manual flash mode, set the mode selector to [M].

2 Press the [SEL] button to select the master flash unit, choose a flash compensation value with the selector dial, and then press the [OK] button.

- Set the flash output level if the flash mode is set to manual flash.

3 Repeat procedure 2 above to set the flash compensation values of the remote flash unit groups (A and B).

- Set the flash output level if the flash mode is set to manual flash.

Advanced Wireless Lighting Operation

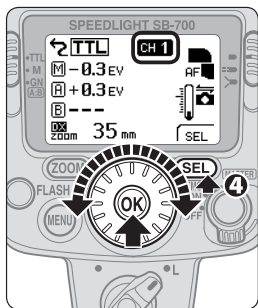

- 4 Press the [SEL] button to highlight the channel, choose CH 1 with the selector dial, and then press the [OK] button.

D Canceling the flash function

- In i-TTL mode, highlight the flash compensation value and rotate the selector dial counterclockwise. Press the [OK] button when the flash compensation value becomes "---" (flash function canceled) after "-3.0EV."
- In manual flash mode, highlight the flash output level and rotate the selector dial. Press the [OK] button when the flash output level becomes "---" (flash function canceled). "---" appears between "1/128" and "1/1."

2. Remote flash unit setting (group, channel and zoom head position)

[Setting group A and channel 1 (example)]

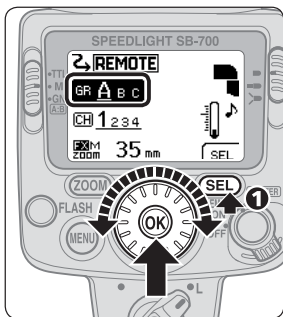

- 1 Press the [SEL] button to highlight the group, choose A for group with the selector dial, and then press the [OK] button.**
 - Group name and channel number being set appears larger.
- 2 Press the [SEL] button to highlight the channel, choose 1 for channel number with the selector dial, and then press the [OK] button.**
 - Be sure to choose the same channel number as set on the master flash unit.

Advanced Wireless Lighting Operation

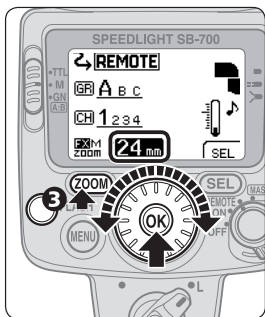

- 3 Press the [ZOOM] button to highlight the zoom head position, choose a zoom head position with the selector dial, and then press the [OK] button.
- 4 Confirm the flash-ready indicator is on, and then shoot.

Quick Wireless Control Mode

The flash output level ratios of two remote flash unit groups (A and B) can be easily balanced in quick wireless control mode.

- The master flash unit does not fire in quick wireless control mode.

Setting quick wireless control mode

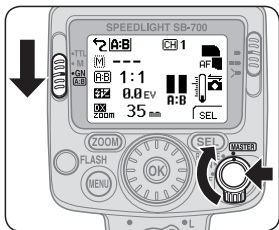

- 1 Set the power switch/
wireless mode switch for
multiple flash units to
[MASTER], and set the
mode selector to [A:B].

- Turn the switch while holding
down the lock release in the
center.

Quick wireless control mode LCD sample

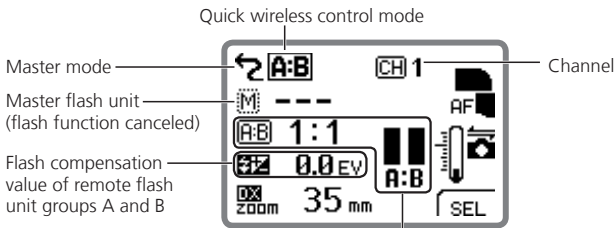

Quick Wireless Control Mode

Taking a picture in quick wireless control mode

1. Master flash unit setting (flash output level ratios, flash compensation value and channel)

[Setting flash output level ratio of 1 : 2 and channel 1 (example)]

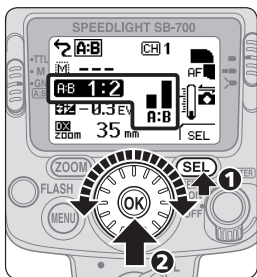

① Press the [SEL] button to highlight the flash output level ratio of remote flash unit groups A and B.

② Set the flash output level ratio to 1 : 2 with the selector dial and press the [OK] button.

- The flash output level ratio can be set within a range of 8 : 1 – 1 : 8.
- The flash function in one of the remote flash unit groups A and B can be canceled.
- Set the flash compensation value if necessary.

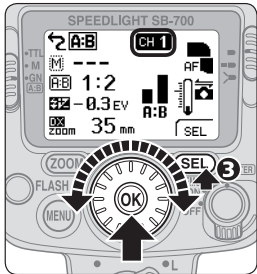

- 3** Press the [SEL] button to highlight the channel, choose CH 1 with the selector dial, and then press the [OK] button.

Quick Wireless Control Mode

2. Remote flash unit setting (group, channel and zoom head position)

[Setting group A and channel 1 (example)]

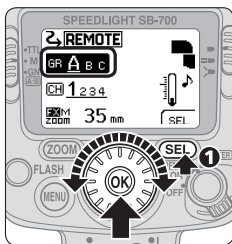

1 Press the [SEL] button to highlight the group, choose A for group with the selector dial, and then press the [OK] button.

- Set the group A or B.
- The selected channel number and group indicator appear larger on the LCD.

2 Press the [SEL] button to highlight the channel, choose 1 for channel number with the selector dial, and then press the [OK] button.

- Be sure to choose the same channel number as set on the master flash unit.

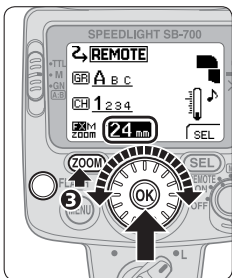

- 3 Press the [ZOOM] button to highlight the zoom head position, choose a zoom head position with the selector dial, and then press the [OK] button.
- 4 Confirm the flash-ready indicator is on, and then shoot.

SU-4 Type Wireless Multiple Flash-unit Photography

SU-4 type wireless multiple flash-unit photography is particularly suited to photographing fast-moving subjects.

- The SB-700 can only be used as a remote flash unit in SU-4 type wireless multiple flash-unit photography.

■ Setting SU-4 type wireless multiple flash-unit photography

① Set the SU-4 type wireless multiple flash-unit photography in custom setting.

- See “Custom Functions and Settings.” (□B-20)

② Set the power switch/wireless mode switch for multiple flash units to [REMOTE].

- Turn the switch while holding down the lock release in the center.

LCD sample

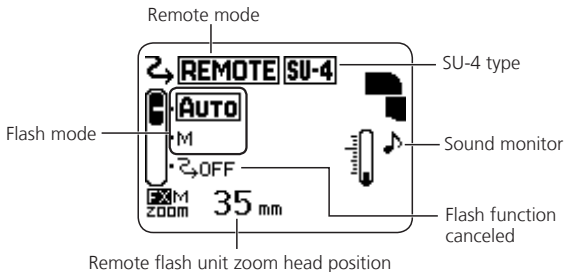

SU-4 Type Wireless Multiple Flash-unit Photography

Flash modes for remote flash units

SU-4 type wireless multiple flash-unit photography can operate in AUTO (auto), M (manual) and OFF (flash function canceled) modes.

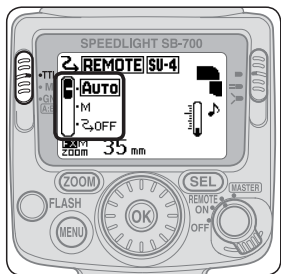

Flash mode can be set with the mode selector.

- Set the mode selector to [TTL] for AUTO (auto), [M] for M (manual), [GN] for OFF (flash function canceled).

AUTO (auto) mode:

- In AUTO mode, the remote flash units start and stop firing in sync with the master flash unit.
- Total flash output level of the master and remote flash units is controlled.
- The maximum distance the SB-700's light sensor can detect is approx. 7 m (23 ft) in front of the master flash unit.

M (manual) mode:

- In M mode, the remote flash units start firing in sync with the master flash unit, but do not stop firing in sync with the master flash unit.
- Flash output levels of the master and remote flash units are separately set.
- The maximum distance the SB-700's light sensor can detect is approx. 40 m (131 ft) in front of the master flash unit.
- The flash output level can be set from M1/1 to M1/128.

OFF (flash function canceled) mode:

- Remote flash units do not fire, even when the master flash unit fires.

✓ To prevent the remote flash units from firing accidentally

Do not leave the remote flash units' power on. Ambient electrical noise caused by static electricity or other such electromagnetic waves can trigger them to fire accidentally. Always turn the power off.

SU-4 Type Wireless Multiple Flash-unit Photography

Setting a remote flash unit for SU-4 type wireless multiple flash-unit photography

[Setting AUTO mode (example)]

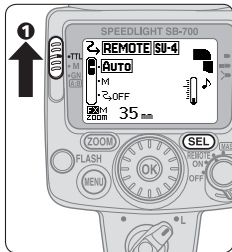

① Set the mode selector to [TTL].

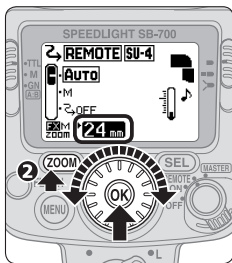

② Press the [ZOOM] button to highlight the zoom head position, choose a zoom head position with the selector dial, and then press the [OK] button.

Setting flash output level in M mode

In M mode, set the flash output level with the [SEL] button.

Remote Flash Units

Remote flash unit setting

- The standby function of the SB-700, SB-910, SB-900, SB-800, SB-600, SB-500 and SB-R200 is canceled when remote mode is set. Make sure that there is sufficient battery power.
- Set the zoom head position of the remote flash units wider than the image area, so that the subject will receive sufficient illumination even when the angle of the flash head is off axis from the subject. When the flash-to-subject distance is very short, set the zoom head position wide enough to achieve sufficient light.

Setting up the remote flash units

- In most cases, position the remote flash unit(s) closer to the subject than the camera, so that light from the master flash unit can reach the light sensor window for wireless remote flash of the remote flash unit(s). This is particularly important when holding a remote flash unit in the hand.

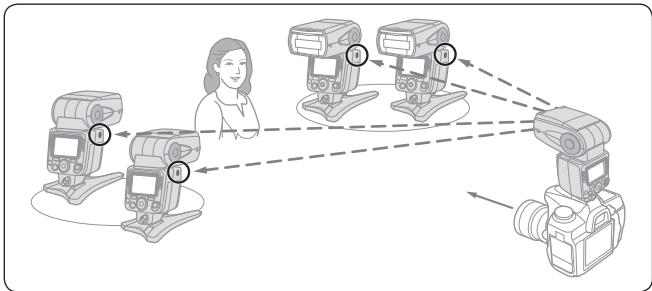

Remote Flash Units

- As a basic guide, the effective distance between the master and remote flash units is approx. 10 m (33 ft) or less in the front position, and approx. 7 m (23 ft) at both sides (in Advanced Wireless Lighting). These ranges vary slightly depending on ambient light.
- There is no limit to the number of remote flash units that can be used together. However, when using many remote flash units, light may be unintentionally picked up by the light sensor of the master flash unit and interfere with correct functioning. The practical number of remote flash units for wireless multiple flash-unit photography is three. In Advanced Wireless Lighting, for practical purposes, the number of remote flash units should be limited to three for one group.

- Place all remote flash units in the same group close together and facing the same direction.

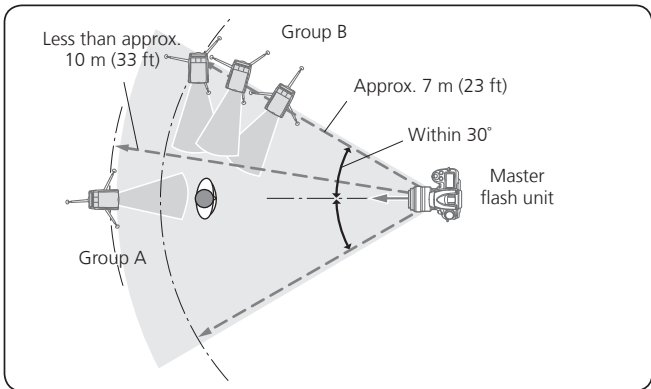

- An obstacle between the master flash unit and remote flash units can interfere with transmission of data.
- Take care not to let light from the remote flash unit enter the camera lens.

Remote Flash Units

- Use the provided Speedlight Stand AS-22 for stable placement of remote flash units. Attach and detach the SB-700 to and from the AS-22 in the same way it is attached to/detached from the camera's accessory shoe.

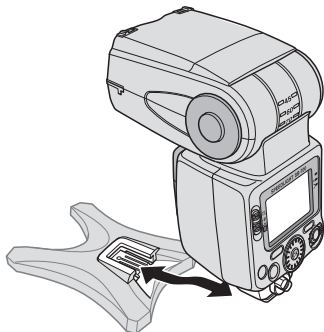

- Be sure to press the master flash unit test firing button to test fire remote flash units after setting up.
- Be sure to confirm the remote flash unit flash-ready indicator is on before photographing.

Checking Status in Wireless Multiple Flash-unit Photography

The flash-ready indicator on the SB-700 and the sound monitor can be used to check that wireless multiple flash-unit photography is operating during and after taking a picture.

- When the SB-700 is used as a wireless remote flash unit, the sound monitor can be used to check operational status. This function can be activated or canceled using custom setting (B-20). It is set to activate as the default.

Checking flash operation using the flash-ready indicator or sound monitor

Master flash unit	Remote flash unit		Speedlight status
Flash-ready indicator	Flash-ready indicator	Sound monitor	
Lights up	The back indicator lights up and the front indicator blinks.	One beep	Ready to fire
Goes out and lights up when ready to fire	The back indicator lights up and the front indicator blinks or goes out.	Two short beeps	Fired properly

Checking Status in Wireless Multiple Flash-unit Photography

Master flash unit	Remote flash unit		Speedlight status
Flash-ready indicator	Flash-ready indicator	Sound monitor	
Blinks for approx. 3 sec.	Quickly blinks for approx. 3 sec.	Three long beeps for approx. 3 sec.	<p>Insufficient flash output for correct exposure*¹ Underexposure due to insufficient flash output may have occurred. To compensate, use a wider aperture or higher ISO sensitivity, or move the flash unit closer to the subject and reshoot.</p>
Goes out and lights up when ready to fire	Quickly blinks for approx. 6 sec.	High and low tone beeps alternate for approx. 6 sec.	<ul style="list-style-type: none"> • Auto aperture flash mode or non-TTL auto flash mode is set on the master flash unit. Change the flash mode to an operable flash mode. • The remote flash unit light sensor has failed to receive the command light from the master flash unit. This is because the light sensor cannot detect when to stop firing in sync with the master flash unit, either due to a reflection from the remote flash unit itself or light from another remote flash unit that may have entered the light sensor window. Change the direction or position of the remote flash unit and reshoot.

*1 Indicators shown below appear when underexposure due to insufficient flash output may have occurred.

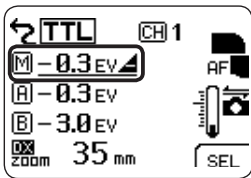

Master flash unit

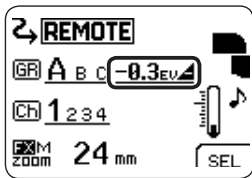

Remote flash unit

E Functions

This section explains the SB-700 functions that support flash photography and camera functions.

- For detailed information regarding camera functions and settings, refer to the camera user's manual.

	Switching illumination patterns (☐☐E-2)	
	Bounce flash operation (☐☐E-5)	
	Taking close-up photographs (☐☐E-13)	
Functions	Flash photography with color filters (☐☐E-17)	Fluorescent filter (included) Incandescent filter (included) SJ-4 color filters (optional)
	Flash photography support functions (☐☐E-23)	Flash compensation Power zoom function AF-assist illumination Test firing Modeling illumination Standby function Thermal cut-out
	Functions to be set on the camera (☐☐E-32)	Auto FP high-speed sync FV lock Slow sync Red-eye reduction/red-eye reduction slow sync Rear-curtain sync

Switching Illumination Patterns

In flash photography, the center of the image is most illuminated, while the edges are darker. The SB-700 provides three types of illumination patterns with different light falloff at edges. Select the suitable pattern according to the photography environment.

Standard



- The basic illumination pattern for common flash photography environments

Switching Illumination Patterns

Center-weighted



- The center-weighted pattern provides larger guide numbers at the center of the image than the standard illumination pattern (the light falloff at the edge will be greater than the standard illumination pattern).
- Suitable for shots, such as portraits, in which the light falloff at the edge of an image can be ignored.

Even



- The light falloff at the edge of the image is less than with the standard illumination pattern.
- Suitable for group photographs, in which sufficient light is required without light falloff at the edges.

To set illumination pattern

The illumination pattern can be set using the illumination pattern selector.

- The selected illumination pattern is indicated with an icon on the LCD.

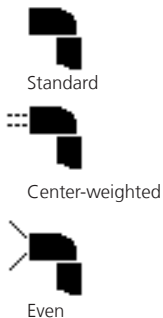
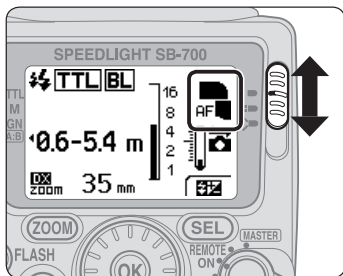

Bounce Flash Operation

Bounce flash is a photographic technique using light that is bounced off a ceiling or wall using a tilted or rotated flash head. This provides the effects listed below compared to those with direct light from a flash unit:

- Overexposure to a subject that is closer than other subjects can be reduced.
- Background shadows can be softened.
- Shine in faces, hair and clothes can be reduced.

The shadows can be softened further using the Nikon Diffusion Dome.

- For more details and comparative example photos, see the separate booklet, "A collection of example photos."

Setting the flash head

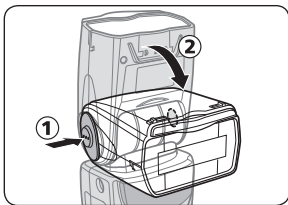

Tilt or rotate the SB-700's flash head by holding down the flash head tilting/rotating lock release button.

- The SB-700's flash head tilts up 90° and down 7°, and rotates horizontally 180° to the left and right.
- Set the flash head at a click stop at the angles shown.

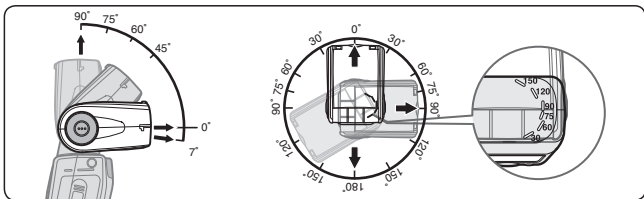

Bounce Flash Operation

■ Setting flash head tilting/rotating angles, and choosing a reflecting surface

- Good results are most easily achieved when the flash head is tilted up to use the ceiling as a reflecting surface.
- Rotate the flash head horizontally to get the same effect when the camera is held in the vertical position.
- Illumination can be softened further when the light is bounced off a ceiling or wall behind the camera, as opposed to in front of the camera.
- Select white or highly reflective surfaces to bounce the light off. Otherwise, image colors will be influenced by the color of the reflecting surface.
- Take care not to let light from the flash unit illuminate the subject directly.
- The effective distance between the flash head and the reflecting surface is approx. 1 m to 2 m (3.3 ft to 6.6 ft) depending on photographic conditions.
- If the reflecting surface is not close enough, a piece of A4-size white paper can be used instead. Please check the subject is exposed to the bounced light before taking a picture.

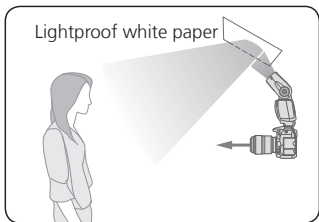
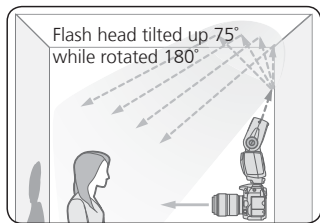
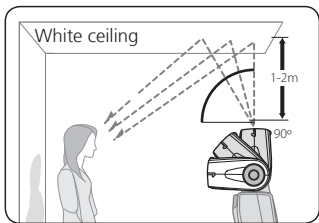

Bounce Flash Operation

Nikon Diffusion Dome

- By attaching the included Nikon Diffusion Dome over the flash head, light can be further diffused during bounce flash photography to create extremely soft light with virtually no shadow.
- The same effect can be achieved with the camera in either horizontal or vertical position.
- Light is more effectively diffused when the built-in wide panel is used. (E-14)

Functions

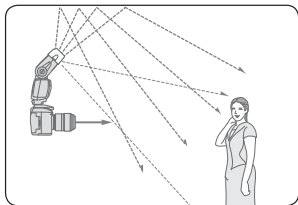

Attaching the Nikon Diffusion Dome

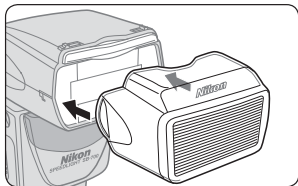

Attach the Nikon Diffusion Dome as shown in the diagram, with the Nikon logo facing up.

Zoom head position indicator

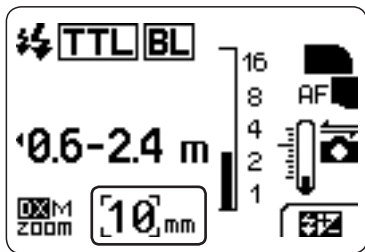

- When the Nikon Diffusion Dome is attached and when the camera's image area is set to FX format, the zoom head position is automatically set at 12 mm, 14 mm or 17 mm. When the camera's image area is set to DX format, the zoom head position is automatically set at 8 mm, 10 mm or 11 mm. The zoom head position differs depending on the illumination pattern. (E-2, H-20)

Bounce Flash Operation

Taking a picture with bounce flash

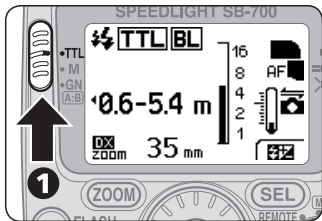

1 Set the mode selector to [TTL].

2 Set the camera's aperture, shutter speed, etc.

- Refer to "Setting the aperture in bounce flash operation."

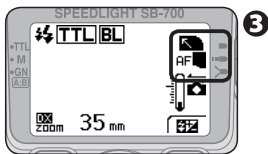

3 Adjust the flash head and shoot.

Setting the aperture in bounce flash operation

- In bounce flash, there is a light loss compared with normal flash photography (with flash head adjusted to front). Therefore, a two- or three-step wider aperture (smaller f-number) should be used. Adjust according to results.
- When the flash head is adjusted to other than the front position, the SB-700 LCD does not display the effective flash output distance range indicator. To ensure correct exposure, first confirm the effective flash output distance range and aperture with the flash head in the front position. Next, set this aperture on the camera.

Using the built-in bounce card

- In bounce flash photography, use the SB-700's built-in bounce card to make a portrait subject's eyes look more vibrant by reflecting the light in them.
- Tilt the flash head up 90°.

Setting the built-in bounce card

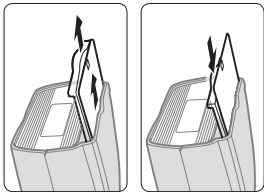

Pull out the bounce card and the built-in wide panel and, while holding the bounce card, slide the built-in wide panel back into place inside the flash head.

- To insert the bounce card, pull out the built-in wide panel again and slide both back into place together.

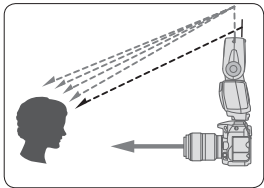

Taking Close-up Photographs

When the flash-to-subject distance is less than approx. 2 m (6.6 ft), tilting down the flash head is recommended to ensure sufficient illumination of the lower part of the subject in close-up photography.

- The bounce-down icon appears and the effective flash output distance range is underlined with a dotted line when the flash head is tilted down.
- With the built-in wide panel, the flash from the SB-700 is diffused. This softens shadows and prevents overexposure.
- When using a long lens, be careful that the light from the flash is not obstructed by the lens barrel.
- Vignetting may occur in close-up flash photography due to the illumination pattern, lens in use, focal length setting, etc. Therefore, make test shots if taking an important picture.

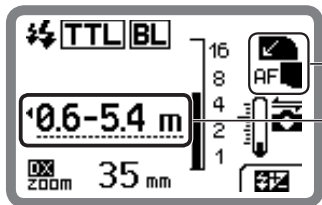
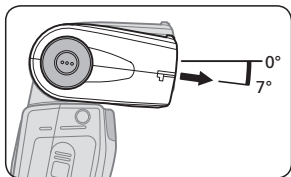

Bounce-down icon

Dotted underline indicates the flash head is tilted down.

■ Setting the built-in wide panel

- ① Carefully pull the built-in wide panel all the way out and position it over the flash head.
- ② Slide the bounce card back into place inside the flash head.
 - To replace the built-in wide panel, lift it up and slide it into the flash head as far as it will go.

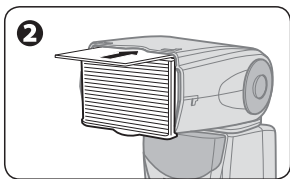
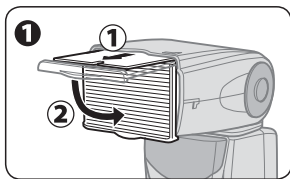

Taking Close-up Photographs

- When the built-in wide panel is attached and the camera's image area is set to FX format, the zoom head position is automatically set at 12 mm, 14 mm or 17 mm. When the camera's image area is set to DX format, the zoom head position is automatically set at 8 mm, 10 mm or 11 mm. The zoom head position differs depending on the illumination pattern. (□E-2, H-20)

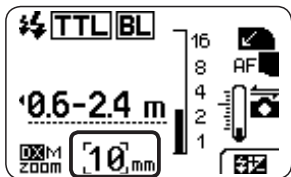

Taking close-ups with bounce-down flash

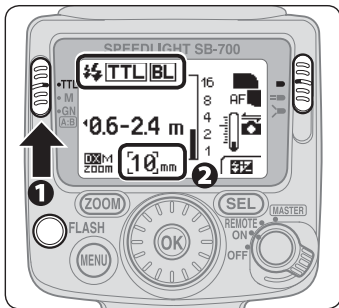

1 Set the SB-700's flash mode.

2 Position the built-in wide panel.

3 Tilt the flash head down.

- The flash-to-subject distance is underlined.

4 Confirm the flash-ready indicator is on, and then shoot.

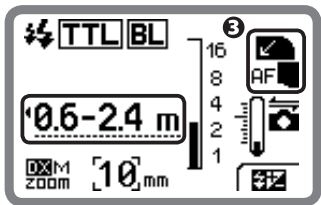

Flash Photography with Color Filters

Color compensation filters, a fluorescent and an incandescent filter, are included with the SB-700 for use with flash photography under incandescent/tungsten and fluorescent lighting.

- For photo examples with colors balanced using color compensation filters, see the separate booklet, "A collection of example photos."
- Color filters (Color Filter Set SJ-4) that change the color of the light emitted by the SB-700 are separately available. (□H-13)

Using color compensation filters and color filters



Filters	Purpose
Fluorescent filter (Fluorescent Filter SZ-3FL), included	Balance the color of light from the flash to match that of fluorescent lighting
Incandescent filter (Incandescent Filter SZ-3TN), included	Balance the color of light from the flash to match that of incandescent or tungsten lighting
Color filters (Color Filter Set SJ-4), optional	Create interesting effects by changing the color of the light emitted by the flash

How to attach color compensation filters (included)

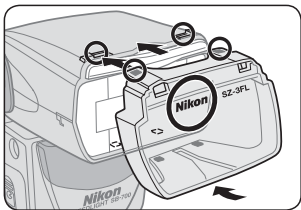

1 Place the filter on the flash head and insert into the slit at the top.

- Place the filter with the Nikon logo facing up, as shown in the diagram.

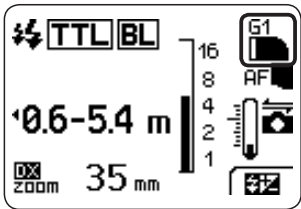

2 Check the LCD.

- Filter type is displayed.
- The information is transmitted to the camera from the SB-700.

G1



Fluorescent filter

A1



Incandescent filter

Flash Photography with Color Filters

How to attach SJ-4 color filters (optional)

Functions

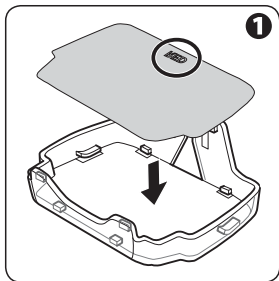

1 Attach the filter to the filter holder (SZ-3) as shown in the diagram.

- Insert the filter with the name of the color filter at bottom.
- The filter should be inserted with the name of the color filter facing out.
- Insert the edges of the filter between the filter holder and the filter attachment tabs.
- Attach the filter to the filter holder without creasing the filter or leaving any gaps.

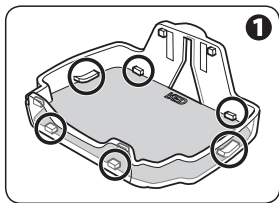

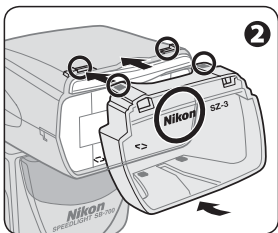



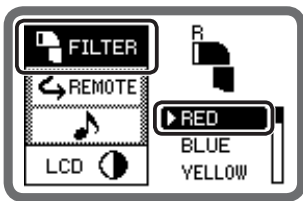

2 Place the filter holder on the flash head with the Nikon logo facing up, as shown in the diagram, and insert it into the slit at the top.

- Once the filter holder is attached, the LCD panel shows the color filter setting display.
- Be sure to attach the filter to the filter holder before placing the filter holder on the flash head.



3 Set the color.

- In custom settings, select the color of the filter attached. (□B-20)

 RED	 YELLOW
 BLUE	 AMBER

Flash Photography with Color Filters

Notes on using SJ-4 color filters

- These filters are consumable items. Replace them when they deteriorate or their colors fade.
- The heat generated from the flash head can warp the filters. However, this will not affect their performance.
- Scratches on the filters will have no effect on performance unless the filters fade in color.
- To remove dust or dirt, wipe the filter lightly with a soft, clean cloth.

Balancing light from the flash using color compensation filters and color filters

When a color compensation filter is attached to the SB-700 while the camera's white balance is set to auto or flash, filter information is automatically transmitted to the camera, and the camera's optimum white balance is automatically adjusted to give the correct color temperature.

- When a SJ-4 color filter is attached to the SB-700, set the camera's white balance to auto, flash or direct sunlight.
- When using the SB-700 with a camera not equipped with filter detection (D2 series, D1 series, D200, D100, D80, D70 series, D60, D50, D40 series), set the camera's white balance according to the filter in use while referring to the following table.
- For more details on white balance, see your camera user's manual.

■ White balance depends on camera in use

Camera	D4S, D4, Df, D810, D800 series, D750, D610, D600, D7200, D7100, D7000, D5500, D5300, D5200, D5100, D3300, D3200	D3X, D3S, D3 ^{*1} , D700, D300S, D300 ^{*2} , D90, D5000, D3100, D3000	D2 series, D1X, D1H, D200, D100, D80, D70 series, D60, D40 series	D1, D50
Filter				
SZ-3FL	Auto, flash	Auto, flash	Not compatible	Not compatible
SZ-3TN	Auto, flash	Auto, flash (A6)	Incandescent (fine tune -1)	Not compatible
Color filters (RED, BLUE, YELLOW, AMBER)	Auto, flash, direct sunlight	Auto, flash, direct sunlight	Auto, flash, direct sunlight	Auto, flash, direct sunlight

- *1 D3 camera with firmware A and firmware B version 2.00 or later.
- *2 D300 camera with firmware A and firmware B version 1.10 or later.
- Please check the image results and adjust the flash compensation value and other settings accordingly.

Flash Photography Support Functions

Flash compensation

Exposure compensation for a flash-illuminated subject without affecting background exposure can be achieved by adjusting the SB-700's flash output level.

- Some plus compensation may be necessary to make the main subject brighter, and some minus compensation to make it darker.
- Flash compensation is possible in i-TTL mode.

Functions

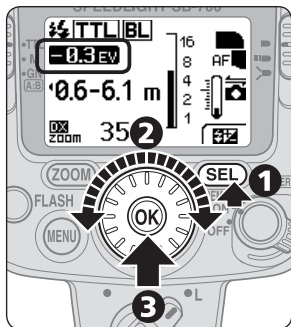

1 Press the [SEL] button to highlight the flash compensation value.

2 Turn the selector dial to set desired flash compensation value.

- The compensation value can be set in 1/3 EV steps from +3.0 EV to -3.0 EV.

3 Press the [OK] button.

Canceling flash compensation

- To cancel, turn the selector dial to return the compensation value to "0."
- Flash compensation cannot be canceled by simply turning the SB-700 off.

For digital SLR cameras with a built-in flash featuring the flash compensation function

- The flash compensation can also be set on the digital SLR camera with a built-in flash. For details, see the camera user's manual.
- If the flash is compensated on both the camera and the Speedlight, the flash output is modified by the sum total of both compensation values. In this case, the SB-700's LCD panel shows only the compensation value set on the SB-700.

Flash Photography Support Functions

Power zoom function

The SB-700 automatically adjusts the zoom head position to match the lens focal length.

- Zoom head positions automatically adjusted differ depending on the settings. For more details, refer to “Specifications.” (□H-20)

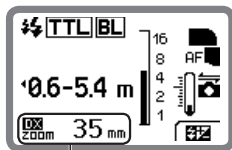



Power zoom function activated

zooM	Power zoom
zooM ^M	Manual setting of zoom head position
14 _{mm}	Nikon Diffusion Dome attached Built-in wide panel in use
16 _{mm}	Zoom head position at the maximum wide-angle position
120 _{mm}	Zoom head position at the maximum telephoto position

■ Setting the zoom head position manually

In order to change the zoom head position to one that does not match the focal length, the zoom head position must be adjusted manually.

- An “” above the “**zoom**” indicator appears on the LCD panel when the zoom head position is set manually.
- Press the [ZOOM] button and then turn the selector dial to set the zoom head position.
- Turn the selector dial clockwise to increase the value, and counter-clockwise to decrease the value.
- The zoom head position can also be adjusted with the [ZOOM] button. In this case, the value increases each time the [ZOOM] button is pressed. Note that the value returns to the widest angle value after the highest telephoto value has been reached.
- In order to reactivate the power zoom function, press the [ZOOM] button to display “” and then press the [SEL] button.

Flash Photography Support Functions

AF-assist illumination

When light is too low for normal autofocus operation, the SB-700's AF-assist illumination enables autofocus photography.

- The SB-700's AF-assist illumination is compatible with the multi-point AF system.
- AF-assist illumination cannot be used with cameras that are not compatible with CLS and COOLPIX cameras.

Notes on using the AF-assist illumination

- AF-assist illumination can be used if an AF lens is mounted and the camera's focus mode is set to S (single-servo AF with focus priority), AF-A, or AF.
- The effective flash-to-subject distance with AF-assist illumination is approx. 1 m to 10 m (3.3 ft to 33 ft) for the center of the image with a 50 mm f/1.8 lens. The flash-to-subject distance varies depending on lens in use.
- Suitable lens focal length is between 24 mm and 135 mm. Focus area in which autofocusing is possible is:

D7000 camera focus area with the focal length range of between 24 mm and 135 mm

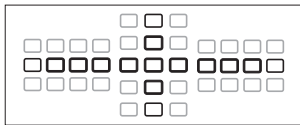

- AF-assist illuminator will not light up if the camera's autofocus is locked or the SB-700's flash-ready indicator does not come on.
- Refer to the camera user's manual for more information.

■ AF-assist illumination

The SB-700's AF-assist illumination can be activated or canceled in the custom setting. (□B-22)



AF: AF-assist illumination activated. (Default)



: AF-assist illumination canceled. No "AF" appears.

✓ When autofocus is not possible while using the AF-assist illumination

If the focus indicator does not appear in the camera's viewfinder even though AF-assist illuminator turns on, focus manually.

✎ Using the SB-700 off-camera

When using the SB-700 off-camera with the TTL Remote Cord SC-29, autofocus in low light is possible because the SC-29 features an AF-assist illumination function. (□H-14)

Flash Photography Support Functions

For cameras with a built-in flash

- Even when the camera's AF-assist illumination is set to activate, the SB-700's AF-assist illumination is given priority and the camera's AF-assist illuminator does not light up.
- The camera's AF-assist illuminator lights up only when the SB-700's AF-assist illumination is canceled.

Test firing

Pressing the test firing button determines whether the SB-700 fires properly.

- The flash output level varies during test firing depending on settings and flash mode.

Modeling illumination

The flash fires repeatedly at a reduced flash output level. This is useful for checking the illumination and shadows cast on a subject before actually taking the picture.

- When the depth-of-field preview button on a camera compatible with modeling illumination is pressed, modeling illuminator fires. For details, see the camera user's manual.
- The flash fires as a modeling illuminator for up to approx. 1 second.

■ Advanced Wireless Lighting

- When the camera's depth-of-field preview button is pressed, the master flash unit (with the flash function activated) and all other remote flash units fire as modeling illuminators at the set flash output level at the selected mode.

■ SU-4 type wireless multiple flash-unit photography

- When the camera's depth-of-field preview button is pressed, only the master flash unit fires as the modeling illuminator.
- The remote flash units also fire according to the modeling illumination of the master flash unit, but these are not modeling illuminations.

■ Standby function

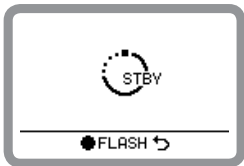

If the SB-700 and camera are not used for a specified time, the standby function is automatically activated to conserve battery power.

- The standby function is activated when the camera's exposure meter is turned off (default setting).
- The standby activation lead time can be adjusted with the custom setting (B-21).

To cancel standby

- Press the camera's shutter-release button halfway.
- Turn the power switch/wireless mode switch for multiple flash units to [ON], [REMOTE] or [MASTER].
- Press the test firing button.

Flash Photography Support Functions

Thermal cut-out

The SB-700 features a function that offers protection against damage to the flash panel and body from overheating. This function does not stop the flash head temperature rising. Be careful not to let the SB-700 overheat during continuous flash use.

- A temperature warning indicator appears when the temperature of the flash panel and body rises as a result of the flash being fired numerous times in quick succession.
- If the temperature continues to rise, the thermal cut-out indicator appears and all operations are suspended before the heat can damage the flash panel and body.

Functions

Indicator at normal temperature

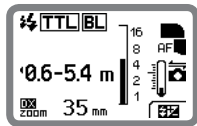

Temperature warning indicator

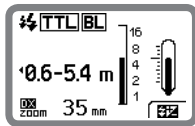

Thermal cut-out indicator



- High
- Wait until the SB-700 cools down.
 - Operation can be resumed once the warning is no longer displayed.
 - On rare occasions, the thermal cut-out indicator might appear or disappear without the temperature changing depending on the zoom head position. This is not a malfunction.

Functions to Be Set on the Camera

The following functions are available when used with cameras so equipped. Set these functions on the camera. They cannot be set on the SB-700 directly.

- For detailed information regarding camera functions and settings, refer to the camera user's manual.

Auto FP high-speed sync

High-speed flash synchronization at a compatible camera's highest shutter speed is possible.

- Auto FP high-speed sync mode is automatically set when the shutter speed exceeds the camera's highest flash sync speed.
- This is useful when a wider aperture is required to achieve shallow depth of field to blur the background.
- Auto FP high-speed sync also operates in Advanced Wireless Lighting.
- Available flash modes are i-TTL, manual flash, and distance-priority manual flash.
- For effective flash output distance range for i-TTL mode and the guide numbers in the auto FP high-speed sync mode, refer to "Specifications." (□H-25)

Functions to Be Set on the Camera

Flash value lock (FV lock)

The SB-700 sets the flash output to locked flash exposure. This maintains the subject's illumination, even if the composition changes.

- The flash exposure level (brightness) remains the same even when the aperture is changed or lens is zoomed in and out, because the flash output level automatically changes.
- Several frames can be shot during FV lock operation.
- FV lock also functions in Advanced Wireless Lighting.
- The available flash modes are i-TTL and quick wireless control.
- FV stands for flash value, meaning flash illuminated subject exposure.

Slow sync

The flash is controlled at a slow shutter speed to obtain the correct exposure for both the main subject and background in low-light situations.

- Since slow shutter speeds are normally used, use of a tripod is recommended to prevent camera shake.

Red-eye reduction/red-eye reduction slow sync

To prevent subject's eyes from appearing red in color pictures shot in low light, the SB-700 fires three flashes at reduced output moments before the picture is taken.

- With red-eye reduction slow sync, red-eye reduction is combined with slow-sync flash.
- Since slow shutter speeds are normally used in red-eye reduction slow sync, use of a tripod is recommended to prevent camera shake.

Rear-curtain sync

In normal flash photography, when photographing fast-moving subjects at slow shutter speeds at night, pictures can appear unnatural because the subject frozen by the flash appears behind or within the blurred movement. Rear-curtain sync flash creates a picture in which the blur of a moving subject appears behind the subject and not in front.

- In front-curtain sync, the flash fires immediately after the front curtain is fully open; in rear-curtain sync, the flash fires moments before the rear curtain starts to close.
- Since slow shutter speeds are usually used, use a tripod to prevent camera shake.



Front-curtain sync



Rear-curtain sync

F For Use with Non-CLS-compatible SLR Cameras

Using the SB-700 with non-CLS-compatible SLR cameras is possible, although some functions may not be operable.

- Operable SB-700 functions vary depending on camera in use.
- See the camera user's manual as well.

Differences between CLS-compatible and non-CLS-compatible Cameras

	CLS-compatible cameras	Non-CLS-compatible cameras
Camera communication  icon	Displayed	Not displayed
Operable flash mode	<ul style="list-style-type: none">• i-TTL• Manual flash• Distance-priority manual flash	<ul style="list-style-type: none">• Manual flash
Advanced Wireless Lighting	Possible	Not possible
SU-4 type wireless multiple flash-unit photography	Possible The SB-700 can only be used as a remote flash unit.	Possible The SB-700 can only be used as a remote flash unit.
Flash photography using color filters	Possible (filter information transferred to the camera compatible with filter detection)	Possible (filter information not transferred)
FV lock	Possible	Not possible

	CLS-compatible cameras	Non-CLS-compatible cameras
Auto FP high-speed sync	Possible	Not possible
Red-eye reduction	Possible	Not possible
Rear-curtain sync	Possible	Possible
AF-assist illumination	Possible (supporting multi-point AF)	Not possible
Firmware update	Possible (with compatible cameras only)	Not possible

G For Use with COOLPIX Cameras

Using the SB-700 with COOLPIX cameras listed below is possible, although some functions may not be operable.

CLS-compatible COOLPIX cameras (A, P7800, P7700, P7100, P7000, P6000)

i-TTL-compatible COOLPIX cameras (P5100, P5000, E8800, E8700, E8400)

- See the camera user's manual as well.

For Use with COOLPIX Cameras

Flash modes and functions when used with COOLPIX cameras

	CLS-compatible COOLPIX cameras	i-TTL-compatible COOLPIX cameras
Operable flash mode	<ul style="list-style-type: none">• Standard i-TTL• Manual flash• Distance-priority manual flash	
Operable wireless mode for multiple flash units*1	<ul style="list-style-type: none">• Advanced Wireless Lighting*2• SU-4 type (The SB-700 can only be used as a remote flash unit.)	<ul style="list-style-type: none">• SU-4 type (The SB-700 can only be used as a remote flash unit.)
FV lock	Not possible	
Auto FP high-speed sync	Not possible	
AF-assist illumination	Not possible	
Firmware update	Not possible	

*1 Note that wireless multiple flash-unit photography using the COOLPIX's built-in flash as a master flash unit and the SB-700 as a remote flash unit is not possible.

*2 Quick wireless control is not possible.

CLS-compatible COOLPIX cameras

- Wireless multiple flash-unit photography is possible when an SB-700, SB-800, SB-900, SB-910 or Wireless Speedlight Commander SU-800 is mounted on the COOLPIX camera accessory shoe as the master flash unit, and flash units such as the SB-700, SB-600, SB-500, SB-800, SB-900 or SB-910 are set to remote mode.
- For more information of camera settings, see the camera user's manual.

Adjusting the zoom head position when used with CLS-compatible COOLPIX cameras

The power zoom function automatically adjusts the zoom head position to match the lens focal length. In this case, **zoom AUTO** appears on the LCD panel, but the zoom head position does not appear on the LCD panel.

H Tips on Speedlight Care and Reference Information

This section explains troubleshooting, Speedlight care, specifications and optional accessories.

Troubleshooting

If a warning indicator appears, use the following chart to determine the cause of the problem before taking the Speedlight to a retailer or Nikon representative for repair.



Problems with the SB-700





Problem	Cause	Solution	☐
The power cannot be turned on.	The batteries are not correctly installed.	Insert the batteries correctly.	B-8
	Battery power is weak.	Replace the batteries.	B-10
The flash-ready indicator does not light up.	The standby function is activated.	<ul style="list-style-type: none">• Press the camera shutter-release button halfway.• Turn the SB-700 on.	E-30
	Battery power is weak.	Replace the batteries.	B-10
The effective flash output distance range does not appear.	The flash head is not set to the front position.	Set the flash head to the front position.	B-13
	Aperture information has not been received from the camera.	<ul style="list-style-type: none">• Check camera settings.• Detach and attach the SB-700 on a camera.	—
	The SB-700 cannot receive focal length information from the camera.	Turn the SB-700 and camera off, and then turn them on again.	—

Problem	Cause	Solution	
Zoom head position is not set automatically.	The built-in wide panel is in use or the Nikon Diffusion Dome is attached.	Remove the built-in wide panel or the Nikon Diffusion Dome.	E-14 E-9
	Power zoom function is canceled.	Activate the power zoom function.	E-25
Remote flash unit does not fire.	The distance between the master flash unit and the remote flash unit is too long, or there is an obstacle between them.	Redo the setup of the master flash unit and remote flash units.	D-23 D-24 D-25
	The light from the master flash unit does not enter the remote flash unit light sensor window for wireless remote flash.		
The SB-700 does not work properly.	Microcomputer may have malfunctioned if this occurs even when fresh batteries are properly installed.	<ul style="list-style-type: none"> • Replace the batteries while the SB-700 is on. • If the problem continues, contact your retailer or Nikon representative. 	B-8
Nonstandard display			
The SB-700 does not operate.	Thermal cut-out is active.	Wait until the SB-700 cools down.	E-31

Troubleshooting

Warning indicators

Warning indicator	Cause	Solution	
 Battery power weak indicator appears.	All operations have stopped due to low battery power.	Replace the batteries.	B-10
 Thermal cut-out indicator appears.	All operations have been suspended because the SB-700 has overheated and could become damaged.	Allow the SB-700 to cool down.	E-31
 Safety circuit activation indicator appears.	All functions other than the power switch are inoperable because of power abnormalities.	Turn off the power, remove the batteries, and contact your retailer or Nikon representative.	—
The flash-ready indicator blinks after firing.	Underexposure may have occurred.	Use a wider aperture or move the flash unit closer to the subject and reshoot.	C-5 C-15 D-28
The remote flash unit beeps for approx. 3 seconds.	Underexposure may have occurred.	Use a wider aperture, move the flash unit closer to the subject or change the position of the flash unit and reshoot.	D-28

Warning indicator	Cause	Solution	
 <p>Incompatible camera warning (CLS-compatible)</p>	<p>The power switch/wireless mode switch for multiple flash units is set to [MASTER] when used with a camera not compatible with Advanced Wireless Lighting multiple flash-unit photography.</p>	<p>Set the power switch/wireless mode switch for multiple flash units to [ON].</p>	F-1
 <p>Incompatible camera warning (non-CLS-compatible)</p>	<p>The mode selector is set to [TTL] or [GN], or the power switch/wireless mode switch for multiple flash units is set to [MASTER] when used with a non-CLS-compatible camera.</p>	<p>Set the power switch/wireless mode switch for multiple flash units to [ON] and the mode selector to [M].</p>	F-1
 <p>Bounce flash warning</p>	<p>Distance-priority manual flash mode was set while the flash head was tilted up or rotated to the right or left.</p>	<ul style="list-style-type: none"> Return the flash head to the front position or tilt it downward. Set the flash mode to i-TTL or manual flash. 	C-14
	<p>Power zoom function does not work properly.</p>	<ul style="list-style-type: none"> Turn the SB-700 off and on again. If the warning indicator remains, contact your retailer or Nikon representative. 	—

Troubleshooting

If the built-in wide panel is broken

- The built-in wide panel may break if subjected to strong knocks while on the flash head.
- In this case, contact your retailer or Nikon representative.
- If the built-in wide panel is broken, it is no longer possible to set the zoom head position to the desired position.

Guide Number, Aperture and Flash-to-subject Distance

The guide number (GN) indicates the amount of light generated by a flash unit. As the number increases, the flash output becomes greater and the light extends further.

There is a relation represented by an equation, guide number (m or ft; for ISO 100) = flash-to-subject distance (m or ft) × f-number of aperture. The SB-700's guide number is 28 m (92 ft) (for ISO 100, zoom head position: 35 mm, FX format, illumination pattern: standard, temperature: 20 °C/68 °F). When ISO sensitivity is 100 and f-number of aperture is 8, the illumination of the SB-700 reaches 3.5 m (11 ft), which is determined by the equation, flash-to-subject distance (3.5 m or 11 ft) = guide number (28 m or 92 ft) / f-number of aperture (8).

- For ISO sensitivities other than 100, multiply the guide number by the factors (ISO sensitivity factors) shown in the table below.

ISO	25	50	100	200	400	800	1600	3200	6400
Factor	0.5	0.71	1	1.4	2	2.8	4	5.6	8

- See “Specifications” for more details. (□H-21)



Determining aperture and flash-to-subject distance for correct exposure

f-number of aperture =
guide number (GN for ISO 100; m or ft) ×
ISO sensitivity factor / flash-to-subject distance (m or ft)

Flash-to-subject distance (m or ft) =
guide number (GN for ISO 100; m or ft) ×
ISO sensitivity factor / f-number of aperture

Tips on Speedlight Care



WARNING

Never use thinner, benzene, or other active agents when cleaning the Speedlight, as this may damage the Speedlight or cause it to catch fire. Using these agents may also impair your health.

■ Cleaning

- Dirt on the flash panel can cause it to break when the flash is fired. Clean the flash panel regularly.
- Use a blower brush to remove dirt and dust from the SB-700 and clean it with a soft, clean cloth. After using the SB-700 near saltwater, wipe the flash unit with a soft, clean cloth moistened slightly with plain water to remove the salt, then dry it using a dry cloth.
- On rare occasions, the LCD may turn on or go dark, due to static electricity. This is not a malfunction. The display will soon return to normal.
- Do not drop the SB-700 or hit it against a hard surface, as this may damage its precision mechanisms. Do not apply strong pressure to the LCD panel.

Storage

- Store the SB-700 in a cool, dry place to prevent malfunctions due to high humidity, as well as the growth of mold or mildew.
- Keep the SB-700 away from chemicals such as camphor or naphthalene. Avoid exposing the SB-700 to magnetic waves from TVs and radios.
- Do not use or leave the SB-700 in locations subject to high temperatures such as those encountered near a heater or stove, as this may cause damage.
- When not using the SB-700 for more than two weeks, be sure to remove the batteries to prevent malfunctions due to battery leakage.
- Take the SB-700 out once a month, insert the batteries and fire the unit several times to refresh the capacitor.

Operating location

- An extreme temperature change can cause condensation to form inside the SB-700. When subjecting the SB-700 to sudden and extreme temperature changes, place it inside an airtight container such as plastic bag. Leave it inside the container for a while before exposing it gradually to the outside temperature.
- Avoid exposing the SB-700 to strong magnetism or radio waves from TVs or high-voltage power transmission towers, as this may cause it to malfunction.

Notes on Batteries

- Because flash consumes a large amount of battery power, batteries may not operate properly before reaching the end of their stated lifespan or the number of charges/discharges as specified by the battery manufacturer.
- When installing batteries, turn off the power of the Speedlight and never reverse the polarity of the batteries.
- If the battery terminals become soiled, remove dirt and smudges before use, as this may cause malfunction.
- Depending on battery specifications, when batteries become hot, the SB-700's safety circuits are activated, cutting off power. This often occurs when the flash unit is operated repeatedly. Battery power will recover when the temperature returns to normal.
- Battery power tends to weaken as the temperature drops. It also gradually decreases when batteries are not used for a long time and recovers after a short break following intensive use. Be sure to check battery power and replace the batteries with fresh ones if you notice any delays in the recycling time.

- Do not store batteries in locations subject to high temperatures and high humidity.
- Be sure to read the user's manuals for your rechargeable batteries and battery charger for detailed information on how to handle and recharge the batteries.
- Never attempt to charge batteries that are not rechargeable batteries, as they could explode.



**Recycling
rechargeable
batteries**

To protect the environment, do not dispose of used rechargeable batteries yourself. Instead, take these batteries to your nearest recycling center.

About the LCD Panel

Characteristics of the LCD panel

- Due to the directional characteristics of LCDs, the LCD panel is difficult to read when viewed from above. However, it can be seen clearly from a somewhat lower angle.
- The LCD panel becomes darker at high temperatures (approx. 60 °C/140 °F), but returns to normal at normal temperatures (20 °C/68 °F).
- The LCD's response time slows down at low temperatures, but returns to normal at normal temperatures (20 °C/68 °F).

LCD panel illuminator ON/OFF

Any button or switch will turn on the SB-700 illuminator (when the SB-700 power is on) to make the LCD panel easier to read.

- The illuminator goes off if the SB-700 is not operated for 16 seconds.
- The SB-700's LCD panel illuminator turns on when the camera's control panel illuminator is turned on.

Adjusting the LCD panel's contrast

The contrast of the LCD panel can be adjusted in the custom setting (□B-21).

- There are nine contrast levels.

Updating Firmware

The latest Nikon firmware can be downloaded from the Nikon website. Firmware is updated through a camera compatible with SB-700 firmware updates.

- For users in the U.S.A.:

<http://www.nikonusa.com/>

- For users in Europe and Africa:

<http://www.europe-nikon.com/support/>

- For users in Asia, Oceania and the Middle East:

<http://www.nikon-asia.com/>

- Additional information may be available from the Nikon representative in your area. See the URL below for contact information:

<http://imaging.nikon.com/>

- SB-700 firmware can be updated through a D3 camera with firmware A and firmware B version 2.00 or later.
- SB-700 firmware can be updated through a D300 camera with firmware A and firmware B version 1.10 or later.
- See the custom setting section to determine which version of firmware you are using (B-22).
- If your camera is not compatible with firmware updates, please contact a Nikon representative in your area.

Cameras not compatible with SB-700 firmware updates

D2 series, D1 series, D200, D100, D80, D70 series, D60, D50, D40 series

Optional Accessories

■ Speedlight Stand AS-22

Same as that provided with this SB-700.

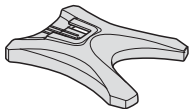

■ Color Filter Set SJ-4

A filter holder, a total of 12 filters in 4 colors and a filter case are included.

- RED
- BLUE
- YELLOW
- AMBER
- Color filters are consumable items and subject to a gradual deterioration in color due to the heat generated when the flash fires. Therefore, it is recommended to check and replace these filters when necessary.

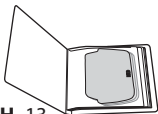

H-13

■ Water Guard WG-AS1, WG-AS2, WG-AS3

Used to protect the camera's accessory shoe contact when the SB-700 is mounted on a Nikon digital SLR camera.

WG-AS1: for D3 series

WG-AS2: for D300 series

WG-AS3: for D700



■ Wireless Slave Flash Controller SU-4

Useful for wireless multiple flash-unit photography, the SU-4 features a built-in, movable light sensor and an accessory shoe for attachment of a remote flash unit. The SU-4's light sensor triggers the remote flash unit to fire in sync with the master flash unit.



■ TTL Remote Cord SC-28/17 (approx. 1.5 m/ 4.9 ft)

The SC-28/17 enables i-TTL mode when the SB-700 is used off-camera. The flash shoe comes with a tripod socket.

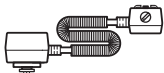

■ TTL Remote Cord SC-29 (approx. 1.5 m/4.9 ft)

The SC-29 enables i-TTL mode when the SB-700 is used off-camera. The SC-29 features an AF-assist illumination function.

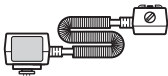

Specifications

Electronic construction	Automatic Insulated Gate Bipolar Transistor (IGBT) and series circuitry
Guide number (at 35 mm zoom head position, in FX format, standard illumination pattern, 20 °C/68 °F)	28/92 (ISO 100, m/ft), 39/128 (ISO 200, m/ft)
Effective flash output distance range (in i-TTL mode)	0.6 m to 20 m (2 ft to 66 ft) (varies depending on camera's image area setting, illumination pattern, ISO sensitivity, zoom head position, and lens aperture in use)
Illumination pattern	There are three illumination patterns: standard, even and center-weighted The light distribution angle is automatically adjusted to the camera's image area in both FX and DX formats
Available flash mode	<ul style="list-style-type: none">• i-TTL• Manual flash• Distance-priority manual flash
Other available functions	Test firing, monitor pre-flashes, AF-assist illumination for multi-point AF, and modeling illumination
Nikon Creative Lighting System	A number of flash operations are available with compatible cameras: i-TTL mode, Advanced Wireless Lighting, FV lock, flash color information communication, auto FP high-speed sync and AF-assist illumination for multi-point AF
Multiple flash-unit photography operation	<ul style="list-style-type: none">• Advanced Wireless Lighting• SU-4 type wireless multiple flash-unit photography (in remote mode)

Flash exposure control set on the camera	Camera's sync modes: slow sync, red-eye reduction slow sync, front-curtain sync, rear-curtain sync, rear-curtain slow sync Photography functions: auto FP high-speed sync, FV lock, red-eye reduction
Bounce capability	Flash head tilts down to 7° or up to 90° with click-stops at -7°, 0°, 45°, 60°, 75°, 90° Flash head rotates horizontally 180° to the left and right with click-stops at 0°, 30°, 60°, 75°, 90°, 120°, 150°, 180°
Power ON/OFF	Rotate the power switch/wireless mode switch for multiple flash units to turn the SB-700 on or off Standby function can also be set
Power source	Use four AA-type batteries of the same brand from any of the following types: <ul style="list-style-type: none"> • 1.5 V alkaline AA batteries • 1.5 V lithium AA batteries • Rechargeable 1.2 V Ni-MH AA batteries For minimum number of flashes and recycling time of each battery, see □H-27
Flash-ready indicator	The SB-700 is fully recycled: lights up Insufficient flash output for correct exposure (in i-TTL or distance-priority manual flash mode): blinks
Flash-ready indicator (in remote mode)	The SB-700 is fully recycled: blinks Insufficient flash output for correct exposure (in i-TTL mode or AUTO mode in SU-4 type wireless multiple flash-unit photography): blinks

Specifications

Flash duration (approx.)	1/1042 sec. at M1/1 (full) output 1/1136 sec. at M1/2 output 1/2857 sec. at M1/4 output 1/5714 sec. at M1/8 output 1/10000 sec. at M1/16 output 1/18182 sec. at M1/32 output 1/25000 sec. at M1/64 output 1/40000 sec. at M1/128 output
Mounting foot lock lever	Provides secure attachment of the SB-700 to camera's accessory shoe using locking plate and locking pin to prevent unintentional detachment
Flash compensation	-3.0 EV to +3.0 EV in increments of 1/3 EV steps in i-TTL mode
Custom setting	11 items
Other functions	Thermal cut-out, firmware update
Dimensions (W × H × D)	Approx. 71 × 126 × 104.5 mm (2.8 × 5.0 × 4.1 in.)
Weight	Approx. 450 g (15.9 oz.) (with four 1.5 V alkaline AA batteries) Approx. 360 g (12.7 oz.) (Speedlight only)
Accessories supplied	Speedlight Stand AS-22, Nikon Diffusion Dome SW-14H, Incandescent Filter SZ-3TN, Fluorescent Filter SZ-3FL, Soft Case SS-700

- These performance specifications are applicable when fresh batteries are used at normal temperatures (20 °C/68 °F).
- Specifications and design are subject to change without any notice.
- Products and brand names are trademarks or registered trademarks of their respective companies.

Effective flash output distance range (for i-TTL mode)

The effective flash output distance range of the SB-700 is between 0.6 m and 20 m (2 ft and 66 ft). The effective flash output distance range differs depending on the camera's image area, illumination pattern, ISO sensitivity, zoom head position and aperture.

- The following table is for FX format and standard illumination pattern.
- The effective flash output distance range for each setting can be seen on the LCD panel (C-4).

Specifications

■ In FX format, standard illumination pattern

Aperture (f)	ISO sensitivity								Zoom head position (mm)										
	12800	6400	3200	1600	800	400	200	100	148A/ WP	148A	14WP	24	28	35	50	70	85	105	120
1.4									4.9 - 2.0	7 - 2.0	7 - 2.0	12 - 2.0	13 - 2.0	14 - 2.0	16 - 2.0	17 - 2.0	18 - 2.0	19 - 2.0	19 - 2.0
2	1.4								3.5 - 2.0	4.9 - 2.0	4.9 - 2.0	8 - 2.0	8.8 - 2.0	9.8 - 2.0	11 - 2.0	12 - 2.0	13 - 2.0	14 - 2.0	14 - 2.0
2.8	2	1.4							2.5 - 2.0	3.5 - 2.0	3.5 - 2.0	5.7 - 2.0	6.2 - 2.0	7 - 2.0	7.6 - 2.0	8.5 - 2.0	8.8 - 2.0	9.3 - 2.0	9.3 - 2.0
4	2.8	2	1.4						1.8 - 2.0	2.5 - 2.0	2.5 - 2.0	4 - 2.0	4.4 - 2.0	4.9 - 2.0	5.4 - 2.0	6 - 2.0	6.2 - 2.0	6.6 - 2.0	6.6 - 2.0
5.6	4	2.8	2	1.4					1.3 - 1.9	1.8 - 2.0	1.8 - 2.0	2.9 - 2.0	3.1 - 2.0	3.5 - 2.0	3.8 - 2.0	4.3 - 2.0	4.4 - 2.0	4.7 - 2.0	4.7 - 2.0
8	5.6	4	2.8	2	1.4				0.9 - 1.3	1.3 - 1.9	1.3 - 1.9	2 - 2.0	2.2 - 2.0	2.5 - 2.0	2.7 - 2.0	3 - 2.0	3.1 - 2.0	3.3 - 2.0	3.3 - 2.0
11	8	5.6	4	2.8	2	1.4			0.7 - 9.7	0.9 - 1.3	0.9 - 1.3	1.5 - 2.0	1.6 - 2.0	1.8 - 2.0	1.9 - 2.0	2.2 - 2.0	2.2 - 2.0	2.4 - 2.0	2.4 - 2.0
16	11	8	5.6	4	2.8	2	1.4		0.6 - 6.9	0.7 - 9.7	0.7 - 9.7	1 - 1.6	1.1 - 1.7	1.3 - 1.9	1.4 - 2.0	1.5 - 2.0	1.6 - 2.0	1.7 - 2.0	1.7 - 2.0
22	16	11	8	5.6	4	2.8	2		0.6 - 4.8	0.6 - 6.9	0.6 - 6.9	0.7 - 1.1	0.8 - 1.2	0.9 - 1.3	1 - 1.5	1.1 - 1.6	1.1 - 1.7	1.2 - 1.8	1.2 - 1.8
32	22	16	11	8	5.6	4	2.8		0.6 - 3.4	0.6 - 4.8	0.6 - 4.8	0.6 - 8	0.6 - 8.7	0.7 - 9.7	0.7 - 10	0.8 - 11	0.8 - 12	0.9 - 13	0.9 - 13
	32	22	16	11	8	5.6	4		0.6 - 2.4	0.6 - 3.4	0.6 - 3.4	0.6 - 5.6	0.6 - 6.1	0.6 - 6.9	0.6 - 7.5	0.6 - 8.4	0.6 - 8.7	0.6 - 9.2	0.6 - 9.2
		32	22	16	11	8	5.6		0.6 - 1.7	0.6 - 2.4	0.6 - 2.4	0.6 - 4	0.6 - 4.3	0.6 - 4.8	0.6 - 5.3	0.6 - 5.9	0.6 - 6.1	0.6 - 6.5	0.6 - 6.5
			32	22	16	11	8		0.6 - 1.2	0.6 - 1.7	0.6 - 1.7	0.6 - 2.8	0.6 - 3	0.6 - 3.4	0.6 - 3.7	0.6 - 4.2	0.6 - 4.3	0.6 - 4.6	0.6 - 4.6
				32	22	16	11		0.6 - 0.8	0.6 - 1.2	0.6 - 1.2	0.6 - 2	0.6 - 2.1	0.6 - 2.4	0.6 - 2.6	0.6 - 2.9	0.6 - 3	0.6 - 3.2	0.6 - 3.2
					32	22	16		0.6 - 0.6	0.6 - 0.8	0.6 - 0.8	0.6 - 1.4	0.6 - 1.5	0.6 - 1.7	0.6 - 1.8	0.6 - 2.1	0.6 - 2.1	0.6 - 2.3	0.6 - 2.3
						32	22		-	0.6 - 0.6	0.6 - 0.6	0.6 - 1	0.6 - 1	0.6 - 1.2	0.6 - 1.3	0.6 - 1.4	0.6 - 1.5	0.6 - 1.6	0.6 - 1.6
							32		-	-	-	0.6 - 0.7	0.6 - 0.7	0.6 - 0.8	0.6 - 0.9	0.6 - 1	0.6 - 1	0.6 - 1.1	0.6 - 1.1

Effective flash output distance range (m)

H BA: With the Nikon Diffusion Dome attached
WP: With the built-in wide panel in place

Angle of coverage (in FX format)

Zoom head position set	Angle of coverage (°)	
	Vertical	Horizontal
12 (BA/WP) ^{*1}	120	130
14 (BA/WP) ^{*2}	110	120
17 (BA/WP) ^{*3}	100	110
24 ^{*4}	60	78
28	53	70
35	45	60
50	34	46
70	26	36
85	23	31
105 ^{*5}	20	27
120 ^{*5}	18	25

Angle of coverage (in DX format)

Zoom head position set	Angle of coverage (°)	
	Vertical	Horizontal
8 (BA/WP) ^{*1}	120	130
10 (BA/WP) ^{*2}	110	120
11 (BA/WP) ^{*3}	100	110
16 ^{*4}	60	78
17 ^{*4}	57	75
18 ^{*4}	55	72
20	50	67
24	44	58
28	39	52
35	32	44
50	25	34
70	20	27
85 ^{*5}	17	24
105 ^{*3}	16	22
120 ^{*3}	15	21

BA: With the Nikon Diffusion Dome attached

WP: With the built-in wide panel in place

*1 Center-weighted illumination pattern

*2 Standard illumination pattern

*3 Even illumination pattern

*4 Standard or center-weighted illumination pattern

*5 Standard or even illumination pattern

Specifications

Guide number table

The SB-700 guide numbers differ depending on the camera's image area, illumination pattern, ISO sensitivity, zoom head position and flash output level.

ISO 100; m

Zoom head position (mm)	FX format			DX format		
	Standard illumination	Center-weighted illumination	Even illumination	Standard illumination	Center-weighted illumination	Even illumination
8 (BA+WP)	-	-	-	-	10	-
8 (BA)	-	-	-	-	14	-
8 (WP)	-	-	-	-	14	-
10 (BA+WP)	-	-	-	10	-	-
10 (BA)	-	-	-	14	-	-
10 (WP)	-	-	-	14	-	-
11 (BA+WP)	-	-	-	-	-	10
11 (BA)	-	-	-	-	-	14
11 (WP)	-	-	-	-	-	14
12 (BA+WP)	-	10	-	-	-	-
12 (BA)	-	14	-	-	-	-
12 (WP)	-	14	-	-	-	-
14 (BA+WP)	10	-	-	-	-	-
14 (BA)	14	-	-	-	-	-
14 (WP)	14	-	-	-	-	-
16	-	-	-	23	25	-
17 (BA+WP)	-	-	10	-	-	-
17 (BA)	-	-	14	-	-	-
17 (WP)	-	-	14	-	-	-
17	-	-	-	23.5	26	-
18	-	-	-	24.5	27	-

Zoom head position (mm)	FX format			DX format		
	Standard illumination	Center-weighted illumination	Even illumination	Standard illumination	Center-weighted illumination	Even illumination
20	–	–	–	26	28.5	23
24	23	25	–	28	30	24
28	25	28	23	29	31.5	26
35	28	30	24	31.5	33	28.5
50	31	33	28	34.5	36	32
70	34	36	31	37	38	36
85	35.5	38	34	38	–	37
105	37	–	36	–	–	37.5
120	38	–	37	–	–	38

BA: With the Nikon Diffusion Dome attached

WP: With the built-in wide panel in place

Specifications

Guide number table (in FX format)

■ Standard illumination pattern, at ISO 100; m/ft

Flash output level	Zoom head position (mm)										
	14			24	28	35	50	70	85	105	120
	WP + BA	BA	WP								
1/1	10/ 32.8	14/ 45.9	14/ 45.9	23/ 75.5	25/ 82	28/ 91.9	31/ 101.7	34/ 111.5	35.5/ 116.5	37/ 121.4	38/ 124.7
1/2	7.1/ 23.3	9.9/ 32.5	9.9/ 32.5	16.3/ 53.5	17.7/ 58.1	19.8/ 65	21.9/ 71.8	24/ 78.7	25.1/ 82.3	26.2/ 86	26.9/ 88.3
1/4	5/ 16.4	7/ 23	7/ 23	11.5/ 37.7	12.5/ 41	14/ 45.9	15.5/ 50.9	17/ 55.8	17.8/ 58.4	18.5/ 60.7	19/ 62.3
1/8	3.5/ 11.5	4.9/ 16.1	4.9/ 16.1	8.1/ 26.6	8.8/ 28.9	9.9/ 32.5	11/ 36.1	12/ 39.4	12.6/ 41.3	13.1/ 43	13.4/ 44
1/16	2.5/ 8.2	3.5/ 11.5	3.5/ 11.5	5.8/ 19	6.3/ 20.7	7/ 23	7.8/ 25.6	8.5/ 27.9	8.9/ 29.2	9.3/ 30.5	9.5/ 31.2
1/32	1.8/ 5.9	2.5/ 8.2	2.5/ 8.2	4.1/ 13.5	4.4/ 14.4	4.9/ 16.1	5.5/ 18	6/ 19.7	6.3/ 20.7	6.5/ 21.3	6.7/ 22
1/64	1.3/ 4.3	1.8/ 5.9	1.8/ 5.9	2.9/ 9.5	3.1/ 10.2	3.5/ 11.5	3.9/ 12.8	4.3/ 14.1	4.4/ 14.4	4.6/ 15.1	4.8/ 15.7
1/128	0.9/ 3	1.2/ 3.9	1.2/ 3.9	2/ 6.6	2.2/ 7.2	2.5/ 8.2	2.7/ 8.9	3/ 9.8	3.1/ 10.2	3.3/ 10.8	3.4/ 11.2

BA: With the Nikon Diffusion Dome attached

WP: With the built-in wide panel in place

Guide number table (in DX format)

■ Standard illumination pattern, at ISO 100; m/ft

Flash output level	Zoom head position (mm)												
	10			16	17	18	20	24	28	35	50	70	85
	WP +BA	BA	WP										
1/1	10/ 32.8	14/ 45.9	14/ 45.9	23/ 75.5	23.5/ 77.1	24.5/ 80.4	26/ 85.3	28/ 91.9	29/ 95.1	31.5/ 103.3	34.5/ 113.2	37/ 121.4	38/ 124.7
1/2	7.1/ 23.3	9.9/ 32.5	9.9/ 32.5	16.3/ 53.5	17/ 55.8	17.7/ 58.1	18.7/ 61.4	19.8/ 65	20.5/ 67.3	21.9/ 71.8	24/ 78.7	26.2/ 86	26.9/ 88.3
1/4	5/ 16.4	7/ 23	7/ 23	11.5/ 37.7	12/ 39.4	12.5/ 41	13.3/ 43.6	14/ 45.9	14.5/ 47.6	15.5/ 50.9	17/ 55.8	18.5/ 60.7	19/ 62.3
1/8	3.5/ 11.5	4.9/ 16.1	4.9/ 16.1	8.1/ 26.6	8.5/ 27.9	8.8/ 28.9	9.4/ 30.8	9.9/ 32.5	10.3/ 33.8	11/ 36.1	12/ 39.4	13.1/ 43	13.4/ 44
1/16	2.5/ 8.2	3.5/ 11.5	3.5/ 11.5	5.8/ 19	6/ 19.7	6.3/ 20.7	6.6/ 21.7	7/ 23	7.3/ 23.9	7.8/ 25.6	8.5/ 27.9	9.3/ 30.5	9.5/ 31.2
1/32	1.8/ 5.9	2.5/ 8.2	2.5/ 8.2	4.1/ 13.5	4.2/ 13.8	4.4/ 14.4	4.7/ 15.4	4.9/ 16.1	5.1/ 16.7	5.5/ 18	6/ 19.7	6.5/ 21.3	6.7/ 22
1/64	1.3/ 4.3	1.8/ 5.9	1.8/ 5.9	2.9/ 9.5	3/ 9.8	3.1/ 10.2	3.3/ 10.8	3.5/ 11.5	3.6/ 11.8	3.9/ 12.8	4.3/ 14.1	4.6/ 15.1	4.8/ 15.7
1/128	0.9/ 3	1.2/ 3.9	1.2/ 3.9	2/ 6.6	2.1/ 6.9	2.2/ 7.2	2.3/ 7.5	2.5/ 8.2	2.6/ 8.5	2.7/ 8.9	3/ 9.8	3.3/ 10.8	3.4/ 11.2

BA: With the Nikon Diffusion Dome attached

WP: With the built-in wide panel in place

Specifications

Guide number table (with auto FP high-speed sync)

■ Standard illumination pattern, at ISO 100; m/ft (in FX format)

Flash output level	Zoom head position (mm)										
	14			24	28	35	50	70	85	105	120
	WP + BA	BA	WP								
1/1	3.6/ 11.8	5.1/ 16.7	5.1/ 16.7	8.4/ 27.6	9.1/ 29.9	10.2/ 33.5	11.3/ 37.1	12.4/ 40.7	12.9/ 42.3	13.5/ 44.3	13.8/ 45.3
1/2	2.6/ 8.5	3.7/ 12.1	3.7/ 12.1	6/ 19.7	6.5/ 21.3	7.3/ 23.9	8/ 26.2	8.8/ 28.9	9.2/ 30.2	9.6/ 31.5	9.8/ 32.2
1/4	1.9/ 6.2	2.6/ 8.5	2.6/ 8.5	4.2/ 13.8	4.6/ 15.1	5.1/ 16.7	5.7/ 18.7	6.2/ 20.3	6.5/ 21.3	6.8/ 22.3	7/ 23
1/8	1.3/ 4.3	1.9/ 6.2	1.9/ 6.2	3/ 9.8	3.3/ 10.8	3.7/ 12.1	4/ 13.1	4.4/ 14.4	4.6/ 15.1	4.8/ 15.7	4.9/ 16.1
1/16	1/ 3.3	1.3/ 4.3	1.3/ 4.3	2.1/ 6.9	2.3/ 7.5	2.6/ 8.5	2.9/ 9.5	3.1/ 10.2	3.3/ 10.8	3.4/ 11.2	3.5/ 11.5
1/32	0.7/ 2.3	1/ 3.3	1/ 3.3	1.5/ 4.9	1.7/ 5.6	1.9/ 6.2	2/ 6.6	2.2/ 7.2	2.3/ 7.5	2.4/ 7.9	2.5/ 8.2
1/64	0.5/ 1.6	0.7/ 2.3	0.7/ 2.3	1.1/ 3.6	1.1/ 3.6	1.3/ 4.3	1.5/ 4.9	1.6/ 5.2	1.7/ 5.6	1.7/ 5.6	1.8/ 5.9
1/128	0.4/ 1.3	0.5/ 1.6	0.5/ 1.6	0.8/ 2.6	0.9/ 3	1/ 3.3	1/ 3.3	1.1/ 3.6	1.2/ 3.9	1.2/ 3.9	1.3/ 4.3

- Guide numbers in the above tables are for when the SB-700 is used with a D3 camera with a 1/500 sec. shutter speed.
- Guide number with auto FP high-speed sync varies depending on the camera's shutter speed. For example, when the shutter speed is changed from 1/500 sec. to 1/1000 sec., the guide number decreases 1 step. The faster the shutter speed, the smaller the guide number.

BA: With the Nikon Diffusion Dome attached

WP: With the built-in wide panel in place

■ Standard illumination pattern, at ISO 100; m/ft (in DX format)

Flash output level	Zoom head position (mm)												
	10			16	17	18	20	24	28	35	50	70	85
	WP +BA	BA	WP										
1/1	3.6/ 11.8	5.1/ 16.7	5.1/ 16.7	8.4/ 27.6	8.6/ 28.2	8.9/ 29.2	9.5/ 31.2	10.2/ 33.5	10.6/ 34.8	11.5/ 37.7	12.6/ 41.3	13.5/ 44.3	13.8/ 45.3
1/2	2.6/ 8.5	3.7/ 12.1	3.7/ 12.1	6/ 19.7	6.1/ 20	6.3/ 20.7	6.7/ 22	7.3/ 23.9	7.5/ 24.6	8.2/ 26.9	8.9/ 29.2	9.6/ 31.5	9.8/ 32.2
1/4	1.9/ 6.2	2.6/ 8.5	2.6/ 8.5	4.2/ 13.8	4.3/ 14.1	4.5/ 14.8	4.8/ 15.7	5.1/ 16.7	5.3/ 17.4	5.8/ 19	6.3/ 20.7	6.8/ 22.3	7/ 23
1/8	1.3/ 4.3	1.9/ 6.2	1.9/ 6.2	3/ 9.8	3/ 9.8	3.1/ 10.2	3.4/ 11.2	3.7/ 12.1	3.8/ 12.5	4.1/ 13.5	4.5/ 14.8	4.8/ 15.7	4.9/ 16.1
1/16	1/ 3.3	1.3/ 4.3	1.3/ 4.3	2.1/ 6.9	2.2/ 7.2	2.2/ 7.2	2.4/ 7.9	2.6/ 8.5	2.7/ 8.9	2.9/ 9.5	3.2/ 10.5	3.4/ 11.2	3.5/ 11.5
1/32	0.7/ 2.3	1/ 3.3	1/ 3.3	1.5/ 4.9	1.6/ 5.2	1.6/ 5.2	1.7/ 5.6	1.9/ 6.2	1.9/ 6.2	2.1/ 6.9	2.3/ 7.5	2.4/ 7.9	2.5/ 8.2
1/64	0.5/ 1.6	0.7/ 2.3	0.7/ 2.3	1.1/ 3.6	1.1/ 3.6	1.1/ 3.6	1.2/ 3.9	1.3/ 4.3	1.4/ 4.6	1.5/ 4.9	1.6/ 5.2	1.6/ 5.2	1.8/ 5.9
1/128	0.4/ 1.3	0.5/ 1.6	0.5/ 1.6	0.8/ 2.6	0.8/ 2.6	0.8/ 2.6	0.8/ 2.6	0.9/ 3	1/ 3.3	1.1/ 3.6	1.2/ 3.9	1.2/ 3.9	1.3/ 4.3

- Guide numbers in the above tables are for when the SB-700 is used with a D3 camera with a 1/500 sec. shutter speed.
- Guide number with auto FP high-speed sync varies depending on the camera's shutter speed. For example, when the shutter speed is changed from 1/500 sec. to 1/1000 sec., the guide number decreases 1 stop. The faster the shutter speed, the smaller the guide number.

BA: With the Nikon Diffusion Dome attached

WP: With the built-in wide panel in place

Specifications

Min. number of flashes/recycling time of each battery

Batteries	Min. recycling time (approx.)*	Min. number of flashes*/recycling time*
Alkaline (1.5 V)	2.5 sec.	160/2.5–30 sec.
Evolta (1.5 V)	2.5 sec.	230/2.5–30 sec.
Lithium (1.5 V)	3.5 sec.	330/3.5–120 sec.
Ni-MH (2600 mAh)	2.5 sec.	260/2.5–30 sec.
Ni-MH (eneloop)	2.5 sec.	230/2.5–30 sec.

* When firing the Speedlight at full output once every 30 seconds (120 seconds with lithium batteries).

- While AF-assist illumination, power zoom and LCD panel illumination are off.
- With fresh batteries. Performance may vary depending on battery freshness or battery specifications.
- Evolta is a registered trade mark of Panasonic Corporation.

Index

- Refer to “Speedlight Parts” (□B-1) for names of parts.

A

A:BD-13
AccessoriesH-13
Advanced Wireless Lighting
.....D-2, D-9
AF-assist illumination E-27
Angle of coverage.....H-20
ApertureC-4
AUTO (auto) mode.....D-20
Auto FP high-speed sync E-32

B

Batteries B-9, H-9
Bounce flash photography E-5
Bounce flash warningH-4
Bounce-down flash E-16
Built-in bounce card..... E-12
Built-in wide panel E-14

C

Center-weighted
(illumination pattern)..... E-3
Channel.....D-4
Close-up photography E-13
CLS.....A-6

CLS-compatible cameras.....A-4
CLS-compatible COOLPIX
cameras G-1
Color compensation filter..... E-17
Color filter E-17
Color Filter Set SJ-4.....H-13
Continuous flash firing..... B-7
COOLPIX..... G-1
CPU lensA-5
Custom settings..... B-17

D

Default settings.....A-6
Distance-priority manual
flash mode.....C-11
DX format.....A-6

E

Effective flash output
distanceA-6
Effective flash output
distance rangeA-6
Effective flash output distance
range tableH-18
Even (illumination pattern) E-3

Index

F

- Filter holder SZ-3..... E-19
- Firmware update.....H-12
- Firmware version..... B-22
- Flash compensation E-23
- Flash compensation value E-23
- Flash function canceled.....D-21
- Flash head B-13, E-6
- Flash head tilting/rotating
 - lock release button..... E-6
- Flash mode C-1, C-6, C-11
- Flash output level.....C-9
- Flash-ready indicator
 - B-15, D-27
- Flash-ready indicator
 - (in remote mode)D-27
- Fluorescent filter E-17
- Front-curtain sync E-34
- FV lock..... E-33
- FX formatA-6
- FX/DX format (image area).....A-6

G

- GN (distance-priority manual flash mode).....C-11
- GN (guide number).....H-6

- Group.....D-4
- Guide numberH-6
- Guide number table.....H-21

I

- Illumination pattern E-2
- Illumination pattern selector... B-6
- Image area (FX/DX format).....A-6
- Incandescent filter..... E-17
- Insufficient flash output for
 - correct exposure C-5, C-15
- ISO sensitivity..... C-4, H-6
- ISO sensitivity factorsH-6
- i-TTL balanced fill-flash.....C-2
- i-TTL mode.....C-1
- i-TTL-compatible COOLPIX cameras G-1

L

- LCD panel.....H-11
- LCD panel illuminatorH-11
- Light sensor window for
 - wireless remote flash.....D-23
- Lock release B-6
- Low battery power
 - indicatorB-10

M

- M (manual) modeD-21
- Manual flash modeC-6
- MASTER.....D-6
- Master flash unit.....A-8, D-6
- Master mode D-4, D-6
- Menu button
([MENU] button)..... B-6
- Metering mode.....C-2
- Min. recycling timeH-27
- Mode selector..... B-6
- Modeling illumination E-29
- Monitor pre-flashes.....A-7
- Mounting foot..... B-11
- Mounting foot lock lever..... B-11
- Multiple flash-unit
photographyD-1

N

- Nikon Creative
Lighting System CLS.....A-6
- Nikon Diffusion Dome..... E-9
- Non-CLS-compatible
SLR camera F-1

O

- OFF (flash function canceled)
modeD-21
- OK button ([OK] button) B-6

P

- Power zoom function..... E-25

Q

- Quick wireless controlD-13

R

- Rear-curtain sync E-34
- Recycling time.....H-27
- Red-eye reduction..... E-34
- Red-eye reduction slow
sync E-34
- REMOTED-8
- Remote flash unit.....A-8
- Remote mode D-4, D-8
- Replacing batteries..... B-10
- Reset B-22

Index

S

- Select button ([SEL] button).... B-6
- Selector dial B-6
- Slow sync..... E-33
- Sound monitor.....D-27
- Sound monitor setting B-20
- Speedlight Stand AS-22D-26
- Standard
(illumination pattern)..... E-2
- Standard i-TTL.....C-2
- Standby function E-30
- Standby function setting B-21
- SU-4 type wireless multiple
flash-unit photography
..... D-3, D-18

T

- Test firing E-29
- Thermal cut-out..... E-31
- TTL remote cord.....H-14

U

- Underexposure due to
insufficient flash
output C-5, C-15, D-28

W

- Warning indicatorH-3
- Water guardH-13
- Wireless mode switch for
multiple flash units..... D-6, D-8
- Wireless multiple
flash-unit photography.....D-1
- Wireless Slave Flash
Controller SU-4.....H-13

Z

- Zoom button
([ZOOM] button) B-6
- Zoom head position E-25



A series of 17 horizontal lines spaced evenly down the page, providing a template for handwriting practice.

Nikon

No reproduction in any form of this manual, in whole or in part (except for brief quotation in critical articles or reviews), may be made without written authorization from NIKON CORPORATION.



NIKON CORPORATION

Printed in Europe

© 2010 Nikon Corporation

TT5E05(11)

8MSA3911-05