

# **Nikon**

## Quick Start Guide

Confirming the Package Contents	3
First Steps	6
Shooting and Playback	15
Using ViewNX 2	22
Other Functions	27
For Your Safety	33

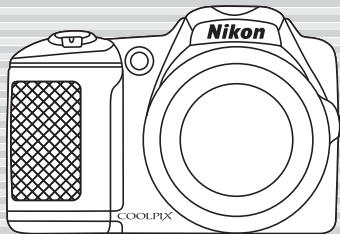

En

### COOLPIX L830

Thank you for purchasing a Nikon COOLPIX L830 digital camera. This guide introduces the procedures necessary for first time use of this camera.

To ensure proper use, please read and thoroughly understand the information in "For Your Safety" (pages 33-36) before using the camera.



### **Downloading the "Reference Manual"**

Refer to the *Reference Manual* (PDF format) for more detailed information. The *Reference Manual* can be downloaded from the Nikon website, and it can be viewed using Adobe Reader.

Downloading and viewing the "Reference Manual".

- 1 Start the computer and access the URL below.  
<http://nikonimglib.com/manual/>
- 2 Select a language and the product name, and download the *Reference Manual*.
- 3 Double-click the downloaded icon.

## **Nikon User Support**

Visit the site below to register your camera and keep up-to-date with the latest product information. You will find answers to frequently asked questions (FAQs) and can contact us for technical assistance.

**<http://www.europe-nikon.com/support>**

### **An Important Notice about Accessories**

Nikon COOLPIX digital camera is designed to the highest standards and includes complex electronic circuitry. Only Nikon accessories, such as battery chargers, batteries, and AC adapters are certified by Nikon specifically for your Nikon COOLPIX camera and are engineered and tested to operate within the requirements of the electronic circuitry of our cameras.

# Confirming the Package Contents

In the event that any items are missing, please contact the store where you purchased the camera.



COOLPIX L830 Digital Camera



Camera Strap

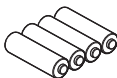

LR6/L40 (AA-size)  
alkaline batteries (x4)\*



Lens Cap LC-CP28  
(with cord)



USB Cable UC-E16

- *Quick Start Guide* (this guide)
- Warranty

\* The included batteries are for trial use only.

**NOTE:** A Secure Digital (SD) memory card, hereafter referred to as a “memory card,” is not included with the camera.

## Parts of the Camera

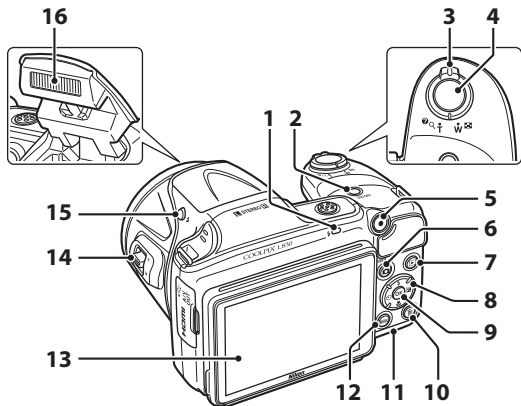

**1** Flash lamp

**2** Power switch/power-on lamp

**3** Zoom control

**4** Shutter-release button

**5** ● (movie-record) button

**6** 📷 (shooting mode) button

**7** ▶ (playback) button

**8** Multi selector

**9** Ⓞ (apply selection) button

**10** 🗑 (delete) button

**11** Battery-chamber/memory card slot cover

**12** MENU (menu) button

**13** Monitor

**14** Side zoom control

**15** ⚡ (flash pop-up) button

**16** Flash

## Changing the Angle of the Monitor

The angle of the monitor can be lowered down to approx. 85° or raised upward to approx. 90°. This is convenient when taking images with the camera held at high or low positions.

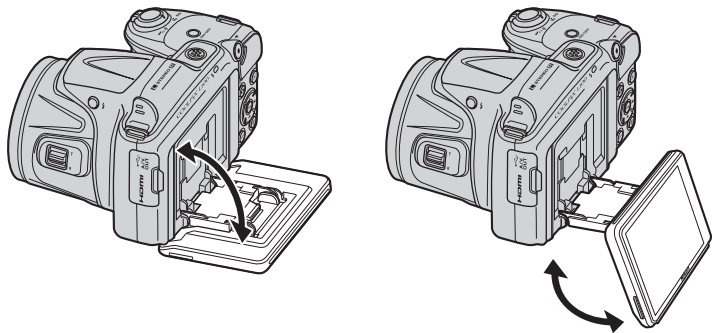

# First Steps

## Step 1 Attach the Camera Strap and Lens Cap

Attach the lens cap to the camera strap, and then attach the strap to the camera.

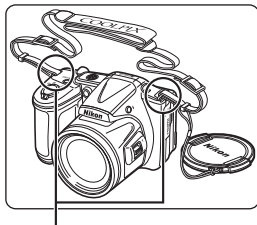
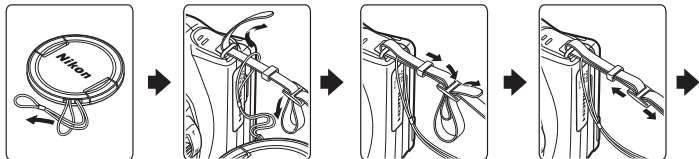

Attach them at two places.

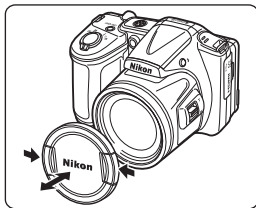

## Step 2 Insert the Batteries and a Memory Card

If a memory card is inserted, images are saved on the memory card when you take images. If a memory card is not inserted, images are saved in the camera's internal memory.

**2.1** Open the battery-chamber/memory card slot cover.

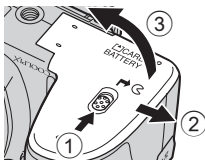

**2.2** Insert the batteries and the memory card.

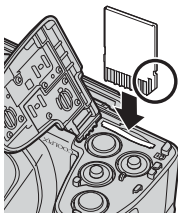
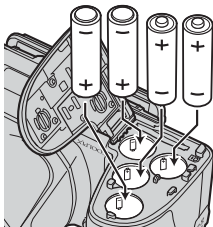

### Removing the memory card

Press the card in to partially eject the card. The card can then be removed by hand.

Slide the memory card in until it clicks into place.

### **When Inserting Batteries or a Memory Card**

- Confirm that the positive (+) and negative (-) terminals are oriented correctly.
- Inserting the memory card upside down or backwards could damage the camera and the memory card. Make sure that the memory card is correctly oriented.

### **Removing the Batteries and the Memory Card**

- Turn the camera off and make sure that the power-on lamp and the monitor have turned off, and then open the battery-chamber/memory card slot cover.
- Hold the camera upside down to prevent the batteries from falling out.
- The camera, batteries, and memory card may be hot immediately after using the camera.

### **Applicable Batteries**

- Four LR6/L40 (AA-size) alkaline batteries
- Four FR6/L91 (AA-size) lithium batteries
- Four EN-MH2 rechargeable Ni-MH (nickel metal hydride) batteries

Performance of alkaline batteries may vary greatly depending on the manufacturer. Choose a reliable brand.

See the *Reference Manual* for more information.



- 
- 2.3** Close the battery-chamber/memory card slot cover.  
Slide the cover while securely holding down the area marked ②.

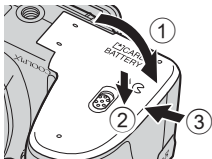



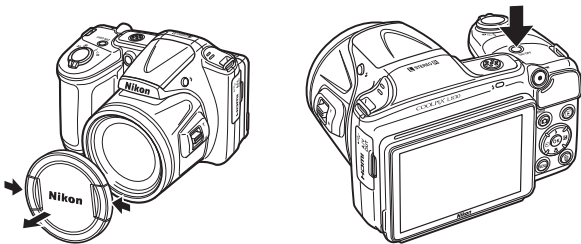

### **Step 3 Turn On the Camera**

Remove the lens cap and press the power switch.

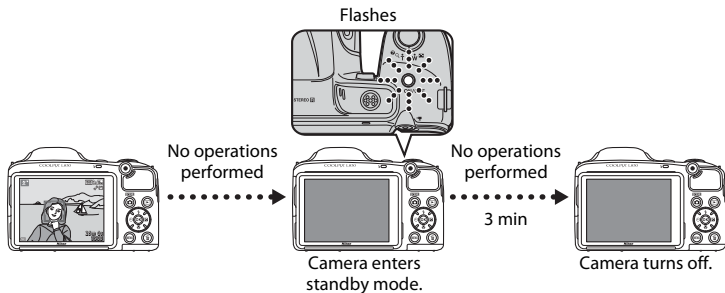

## The Auto Off Function



- The time that elapses before the camera enters standby mode is about 30 seconds. The time can be changed using the **Auto off** setting in the setup menu.
- While the camera is in standby mode, the monitor turns back on if you perform any of the following operations:
  - Press the power switch, shutter-release button,  (shooting mode) button,  (playback) button, or  (movie-record) button

## step 4 **Select a Language and Set the Camera Clock**

When the camera is turned on for the first time, the language-selection screen and the date and time setting screen for the camera clock are displayed. Use the multi selector to make the settings.

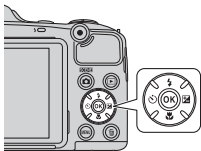

**4.1**

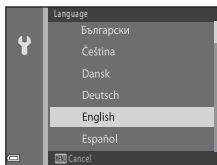

Use the multi selector ▲▼ to select the desired language and press the **OK** button.

**4.2**

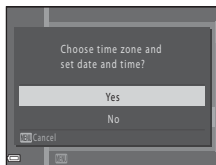

Select **Yes** and press the **OK** button.

## 4.3

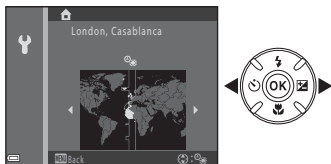

Select your home time zone and press the **OK** button.

## Daylight Saving Time

If daylight saving time is in effect, press ▲ to enable the daylight saving time function.

- When the daylight saving time function is enabled, ☀ is displayed above the map.
- To turn off the daylight saving time function press ▼.

## 4.4

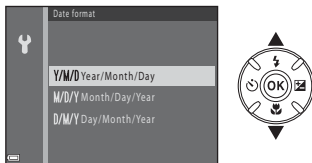

Select the date format and press the **OK** button.

## 4.5

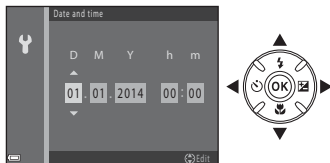

Set the date and time.

- Select a field: Press ◀▶ (changes between **D**, **M**, **Y**, **h**, and **m**).
- Edit the date and time: Press ▲▼.
- Confirm the setting: Select **m** and press the **OK** button.

## 4.6

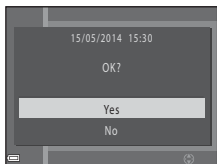

Select **Yes** and press the **OK** button.

## 4.7

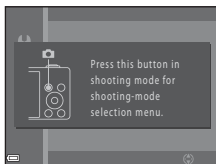

Make sure that the lens cap has been removed and then press the **SCENE** button.

- The shooting-mode selection screen is displayed.

## 4.8

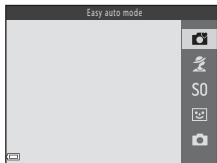

When **Easy auto mode** is displayed, press the **OK** button.

- The camera enters the shooting mode and you can take images in easy auto mode.

The next step explains basic shooting operations using **SCENE** (easy auto) mode.

## **Imprinting the Shooting Date on Printed Images**

After setting the date and time, enable print date from the **Print date** option in the  (setup) menu.

Display the  (setup) menu (30) using the following procedure and change the settings. Press the **MENU** button → press the multi selector  → press  to select the  (setup) menu icon and press the  button → press  to select **Print date** and press the  button.

## **Changing the Language Setting and the Date and Time Setting**



Follow the procedure above and select **Language** or **Time zone and date**.

: This icon indicates that more information is available elsewhere in this guide.

# Shooting and Playback

## Step 1 Check the Battery Level and the Number of Exposures Remaining

### Battery level indicator

Display	Description
	The battery level is high.
	The battery level is low.
Battery exhausted.	The camera cannot capture images. Replace the batteries.



Battery level indicator

Number of exposures remaining

### Number of Exposures Remaining

The number of images that can be taken is displayed.

**N** is displayed when no memory card is inserted in the camera, and images are saved in the internal memory.

## Step 2 *Frame a Picture*

### 2.1 Hold the camera steady.

- Keep fingers and other objects away from the lens, flash, AF-assist illuminator, microphone, and speaker.

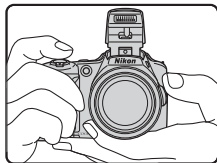

### Using the Flash

In situations where you want to use the flash, such as in dark locations or when the subject is backlit, press the  (flash pop-up) button to raise the flash.

- When the flash is lowered,  is displayed to indicate that the flash does not fire.
- Push the flash down gently to lower the flash until it clicks into place when not in use.

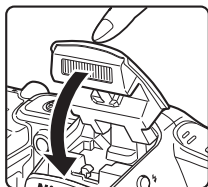
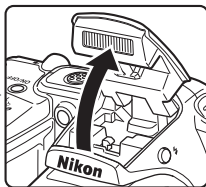
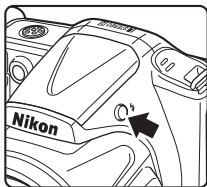



## 2.2 Frame the picture.

- When the camera automatically determines the scene mode, the shooting mode icon changes.



### Using the Zoom

Move the zoom control.

- To zoom in closer to the subject, move toward **T** (telephoto).
- To zoom out and view a larger area, move toward **W** (wide-angle).

When you turn the camera on, the zoom moves to the maximum wide-angle position.

- The side zoom control can also be moved toward **T** or **W** to operate the zoom.

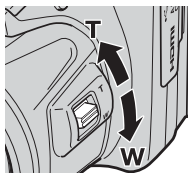
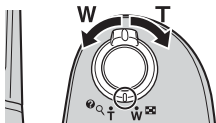

## Step 3 **Focus and Shoot**

- 3.1** Press the shutter-release button halfway, stopping when you feel resistance.
- When the subject is in focus, the focus area glows green (multiple focus areas can glow green).
  - When you are using digital zoom, the camera focuses on the subject in the center of the frame and the focus area is not displayed. When the camera has focused, the focus indicator glows green.
  - If the focus area or focus indicator flashes, the camera is unable to focus. Modify the composition and try pressing the shutter-release button halfway again.

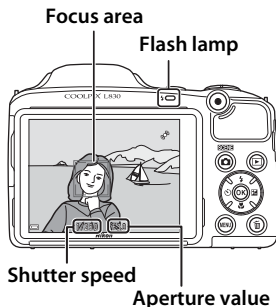
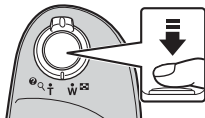

### **Flash lamp**

The status of the flash can be confirmed by pressing the shutter-release button halfway.

	On	The flash fires when you press the shutter-release button all the way down.
	Flashing	The flash is charging.*
	Off	The flash does not fire when an image is taken.

\* If the battery level is low, the monitor turns off while the flash is charging.

---





**3.2** Without lifting your finger, press the shutter-release button the rest of the way down.

- The shutter is released and the image is saved to the memory card or internal memory.
- If you press the shutter-release button with too much force, the camera may shake, causing images to be blurred. Press the button gently.



## Step 4 **Play Back Images**

Press the  (playback) button. The camera enters playback mode.

- To display previous or subsequent images, use the multi selector   .
- To return to shooting mode, press the  button or shutter-release button.

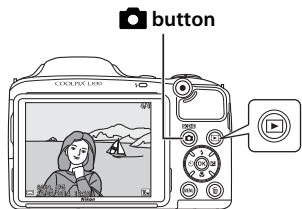



**Display the previous image**





**Display the next image**

## Deleting Images

To delete the image currently displayed in the monitor, press the  (delete) button.

When the deletion screen is displayed, use the multi selector   to select **Current image** and press the  button.

When the confirmation dialog is displayed, select **Yes** and press the  button to delete the image that is displayed.

- After pressing the  button, select **Erase selected images** and select multiple images to be deleted. Select **All images** to delete all images.
- **Deleted images cannot be recovered.** To cancel without deleting, select **No** in the confirmation dialog and press the  button.

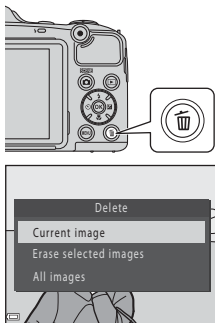

# Using ViewNX 2

Install ViewNX 2 to upload, view, edit, and share photos and movies.

## Your Imaging Toolbox

ViewNX 2™



## Installing ViewNX 2

An Internet connection is required.

For system requirements and other information, see the Nikon website for your region.

---

**1** Download the ViewNX 2 installer.

Start the computer and download the installer from:

*<http://nikonimglib.com/nvnx/>*

---

**2** Double-click the downloaded file.

---

**3** Follow the on-screen instructions.

---

**4** Exit the installer.

Click **Yes** (Windows) or **OK** (Mac).

# Transferring Images to the Computer

## 1 Choose how images will be copied to the computer.

Choose one of the following methods:

- **Direct USB connection:** Turn the camera off and ensure that the memory card is inserted in the camera. Connect the camera to the computer using the USB cable. Turn the camera on.  
To transfer images that are saved in the camera's internal memory, remove the memory card from the camera before connecting it to the computer.

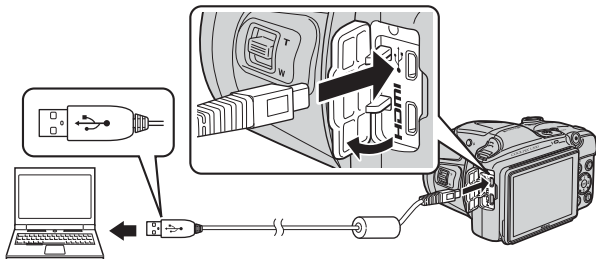

- **SD card slot:** If your computer is equipped with an SD card slot, the card can be inserted directly in the slot.
- **SD card reader:** Connect a card reader (available separately from third-party suppliers) to the computer and insert the memory card.

If a message is displayed prompting you to choose a program, select Nikon Transfer 2.



- **When using Windows 7**

If the dialog shown at right is displayed, follow the steps below to select Nikon Transfer 2.

- 1 Under **Import pictures and videos**, click **Change program**. A program selection dialog will be displayed; select **Import File using Nikon Transfer 2** and click **OK**.
- 2 Double-click **Import File**.



If the memory card contains a large number of images, it may take a while for Nikon Transfer 2 to start. Wait until Nikon Transfer 2 starts.

## ✓ Connecting the USB Cable

The connection may not be recognized if the camera is connected to the computer via a USB hub.

## 2 Transfer images to the computer.

- Click **Start Transfer**.

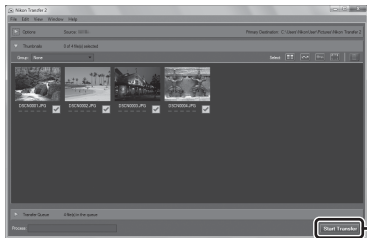

Start Transfer

- At default settings, all the images on the memory card will be copied to the computer.

---

### 3 Terminate the connection.

- If the camera is connected to the computer, turn the camera off and disconnect the USB cable. If you are using a card reader or card slot, choose the appropriate option in the computer operating system to eject the removable disk corresponding to the memory card, and then remove the card from the card reader or card slot.

## Viewing Images

---

### Start ViewNX 2.

- Images are displayed in ViewNX 2 when transfer is complete.
- Consult online help for more information on using ViewNX 2.

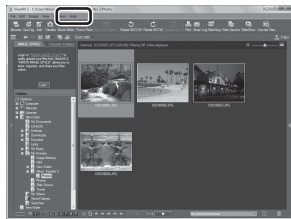

### Starting ViewNX 2 Manually

- **Windows:** Double-click the **ViewNX 2** shortcut on the desktop.
- **Mac:** Click the **ViewNX 2** icon in the Dock.

# Other Functions

## Flash Mode, Self-Timer, Macro Mode, and Exposure Compensation

Use the multi selector in shooting mode to apply the following settings. Availability depends on the setting.

### Flash Mode

The flash modes available are **⚡AUTO** (auto), **⚡👁** (auto with red-eye reduction), **⚡** (fill flash), and **⚡SLOW** (slow sync) modes.

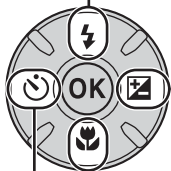
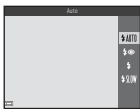

### Exposure Compensation

Overall image brightness can be adjusted by setting exposure compensation before taking images.



### Macro Mode

The camera can focus at a closer distance when the zoom is at a position where **🌸** and the zoom indicator glow green.

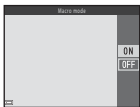

### Self-Timer

The camera is equipped with a ten- or two-second timer for self-portraits.





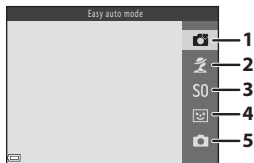
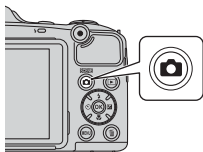

## Selecting a Shooting Mode

Press the  button in shooting mode to display the shooting-mode selection screen.

Use the multi selector   to select the desired shooting mode and press the  button.





1.  Easy auto mode
2.  Scene mode\*
3. **SO** Special effects mode\*
4.  Smart portrait mode
5.  Auto mode

\* The icon displayed varies depending on which scene or effect was selected last.

## Auto Mode

Used for general shooting.

Image mode, white balance, continuous shooting, ISO sensitivity, color options, and AF area mode in the shooting menu ( 30) can be set for shooting. You can also change the flash mode setting ( 27).

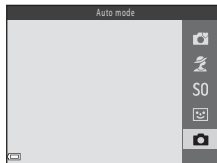

## Scene Mode

Camera settings are automatically optimized according to the scene that you select.

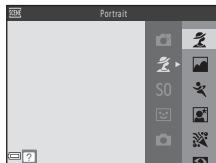

## Recording Movies

You can record movies by simply pressing the



(movie-record) button. Press the



(movie-record) button to start movie recording.

Press the ● (movie-record) button again to end recording.

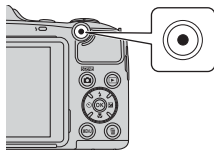

## Using Camera Menus

A variety of shooting and playback settings can be adjusted from the camera menu.

Press the **MENU** button to display the menu for the current mode and use the multi selector to select a menu option (📖 4).

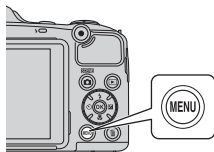

Select one of the menu icons on the left side of the monitor to display the contents of the corresponding menu.

Press the **MENU** button again to exit the menu.

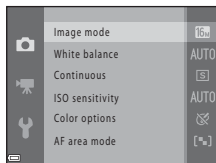

## Switching Between Menus

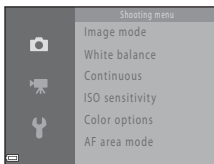

Press the multi selector **◀**. The current menu icon is displayed in yellow.

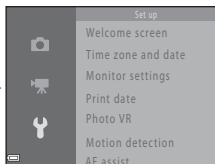

Press **▲▼** to select the desired menu icon, and press either the **OK** button or **▶**.

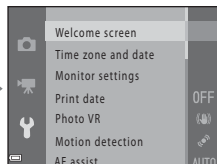







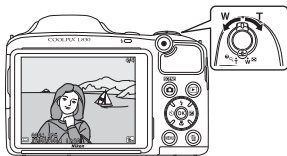

The menu options become selectable.

## Playback Mode

The following options are available in full-frame playback mode.



To	Use	Description
Select images		Press the multi selector <b>▲▼◀▶</b> to display previous or subsequent images. Press and hold <b>▲▼◀▶</b> to scroll through the images quickly.
View thumbnails/ enable calendar display	<b>W</b> 	Displays images thumbnails. Move the zoom control toward <b>W</b>  in the thumbnail playback mode to switch to the calendar display.
Zoom during playback	<b>T</b> 	Magnifies the image displayed in the monitor. Press the <b>OK</b> button to return to full-frame playback mode.
Play back movies		Plays back the movie currently displayed.
Delete image		Allows you to delete images.
Display menus	<b>MENU</b>	Displays the menu for the selected mode.

To	Use	Description
Switch to shooting mode		Press the  button or shutter-release button to switch to shooting mode.
		



# For Your Safety

To prevent damage to your Nikon product or injury to yourself or to others, read the following safety precautions in their entirety before using this equipment. Keep these safety instructions where all those who use the product will read them.



This icon marks warnings, information that should be read before using this Nikon product, to prevent possible injury.

## WARNINGS

### **Turn off in the event of malfunction**

Should you notice smoke or an unusual smell coming from the camera or AC adapter, unplug the AC adapter and remove the batteries immediately, taking care to avoid burns. Continued operation could result in injury. After removing or disconnecting the power source, take the equipment to a Nikon-authorized service representative for inspection.

### **Do not disassemble**

Touching the internal parts of the camera or AC adapter could result in injury.

Repairs should be performed only by qualified technicians. Should the camera or AC adapter break open as the result of a fall or other accident, take the product to a Nikon-authorized service representative for inspection, after unplugging the product and/or removing the batteries.

### **Do not use the camera or AC adapter in the presence of flammable gas**

Do not use electronic equipment in the presence of flammable gas, as this could result in explosion or fire.

**⚠ Handle the camera strap with care**  
Never place the strap around the neck of an infant or child.

**⚠ Keep out of reach of children**  
Particular care should be taken to prevent infants from putting the batteries or other small parts into their mouths.

**⚠ Do not remain in contact with the camera, battery charger, or AC adapter for extended periods while the devices are on or in use**

Parts of the devices become hot. Leaving the devices in direct contact with the skin for extended periods may result in low-temperature burns.

**⚠ Do not leave the product where it will be exposed to extremely high temperatures, such as in an enclosed automobile or in direct sunlight**

Failure to observe this precaution could cause damage or fire.

**⚠ Observe caution when handling batteries**

Batteries may leak or explode if improperly handled. Observe the following precautions when handling batteries for use in this product:

- Before replacing the batteries, turn the product off. If you are using an AC adapter, be sure it is unplugged.
- Use only the batteries approved for use in this product (📖8). Do not combine old and new batteries or batteries of different makes or types.
- When charging Nikon EN-MH2 rechargeable Ni-MH batteries, use only the specified charger and charge the batteries four at a time. When replacing the batteries with EN-MH2-B2 batteries (available separately), purchase two sets (total of four batteries).
- The EN-MH2 rechargeable batteries are for use with Nikon digital cameras only, and are compatible with COOLPIX L830.
- Insert batteries in the correct orientation.
- Do not short or disassemble batteries or attempt to remove or break battery insulation or casing.

- Do not expose batteries to flame or to excessive heat.
  - Do not immerse in or expose to water.
  - Do not transport or store with metal objects such as necklaces or hairpins.
  - Batteries are prone to leakage when fully discharged. To avoid damage to the product, be sure to remove the batteries when no charge remains.
  - Discontinue use immediately should you notice any change in the batteries, such as discoloration or deformation.
  - If liquid from damaged batteries comes in contact with clothing or skin, rinse immediately with plenty of water.
- Do not damage, modify, forcibly tug or bend the power cable, place it under heavy objects, or expose it to heat or flame. Should the insulation be damaged and the wires become exposed, take it to a Nikon-authorized service representative for inspection. Failure to observe these precautions could result in fire or electric shock.
  - Do not handle the plug or battery charger with wet hands. Failure to observe this precaution could result in electric shock.
  - Do not use with travel converters or adapters designed to convert from one voltage to another or with DC-to-AC inverters. Failure to observe this precaution could damage the product or result in overheating or fire.

 **Observe the following precautions when handling the Battery Chargers (available separately)**

- Keep dry. Failure to observe this precaution could result in fire or electric shock.
- Dust on or near the metal parts of the plug should be removed with a dry cloth. Continued use could result in fire.
- Do not handle the power cable or go near the battery charger during lightning storms. Failure to observe this precaution could result in electric shock.

 **Use appropriate cables**

When connecting cables to the input and output jacks, use only the cables provided or sold by Nikon for the purpose, to maintain compliance with product regulations.

**⚠ Handle moving parts with care**

Be careful that your fingers or other objects are not pinched by the lens cover or other moving parts.

**⚠ Observe caution when using the flash**

Using the flash close to your subject's eyes could cause temporary visual impairment. The flash should be no less than 1 m (3 ft 4 in.) from the subject. Particular care should be observed when photographing infants.

**⚠ Do not operate the flash with the flash window touching a person or object**

Failure to observe this precaution could result in burns or fire.

**⚠ Avoid contact with liquid crystal**

Should the monitor break, care should be taken to avoid injury caused by broken glass and to prevent liquid crystal from the monitor touching the skin or entering the eyes or mouth.

**⚠ Turn the power off when using inside an airplane or the hospital**

Turn the power off while inside the airplane during take off or landing. Do not use wireless network functions while in the air. Follow the instructions of the hospital when using while in a hospital. The electromagnetic waves emitted by this camera may disrupt the electronic systems of the airplane or the instruments of the hospital. If you are using an Eye-Fi card, remove it from the camera before boarding an aircraft or entering a hospital.

# Notices

## Notice for Customers in Europe

This symbol indicates that electrical and electronic equipment is to be collected separately.



The following apply only to users in European countries:

- This product is designated for separate collection at an appropriate collection point. Do not dispose of as household waste.
- Separate collection and recycling helps conserve natural resources and prevent negative consequences for human health and the environment that might result from incorrect disposal.
- For more information, contact the retailer or the local authorities in charge of waste management.

This symbol on the batteries indicates that the batteries are to be collected separately. The following apply only to users in European countries:



- All batteries, whether marked with this symbol or not, are designated for separate collection at an appropriate collection point. Do not dispose of as household waste.
- For more information, contact the retailer or the local authorities in charge of waste management.

## Caring for the Camera

To ensure continued enjoyment of this Nikon product, observe the precautions described below in addition to the warnings in “For Your Safety” (📖33-36) when using or storing the device.

### ✔ Do Not Drop

The product may malfunction if subjected to strong shock or vibration.

### ✔ Handle the Lens and All Moving Parts with Care

Do not apply force to the lens, lens cover, monitor, memory card slot, or battery chamber. These parts are easily damaged. Applying force to the lens cover could result in camera malfunction or damage to the lens. Should the monitor break, care should be taken to avoid injury caused by broken glass and to prevent the liquid crystal from the display touching the skin or entering the eyes or mouth.

### ✔ Keep Dry

The device will be damaged if immersed in water or subjected to high humidity.

### ✔ Avoid Sudden Changes in Temperature

Sudden changes in temperature, such as when entering or leaving a heated building on a cold day, can cause condensation to form inside the device. To prevent condensation, place the device in a carrying case or a plastic bag before exposing it to sudden changes in temperature.

### ✔ Keep away from Strong Magnetic Fields

Do not use or store this device in the vicinity of equipment that generates strong electromagnetic radiation or magnetic fields. Strong static charge or the magnetic fields produced by equipment such as radio transmitters could interfere with the monitor, damage data saved on the memory card, or affect the product’s internal circuitry.

## ✔ **Do Not Point the Lens at Strong Light Sources for Extended Periods**

Avoid pointing the lens at the sun or other strong light sources for extended periods when using or storing the camera. Intense light may cause deterioration of the image sensor, producing a white blur effect in photographs.

## ✔ **Turn the Product off Before Removing or Disconnecting the Power Source**

Do not remove the batteries while the product is on, or while images are being saved or deleted. Forcibly cutting power in these circumstances could result in loss of data or in damage to product memory or internal circuitry.

## ✔ **Notes About the Monitor**

- Monitors and electronic viewfinders are constructed with extremely high precision; at least 99.99% of pixels are effective, with no more than 0.01% being missing or defective. Hence while these displays may contain pixels that are always lit (white, red, blue, or green) or always off (black), this is not a malfunction and has no effect on images recorded with the device.
- Images in the monitor may be difficult to see under bright lighting.
- The monitor is lit by an LED backlight. Should the monitor begin to dim or flicker, contact your Nikon-authorized service representative.

## ✔ **About the Manuals**

Nikon will not be held liable for any damages resulting from the use of this product.

## Before Taking Important Pictures

Before taking pictures on important occasions (such as at weddings or before taking the camera on a trip), take a test shot to ensure that the camera is functioning normally. Nikon will not be held liable for damages or lost profits that may result from product malfunction.

## Disposing of Data Storage Devices

Please note that deleting images or formatting data storage devices such as memory cards or built-in camera memory does not completely erase the original image data. Deleted files can sometimes be recovered from discarded storage devices using commercially available software, potentially resulting in the malicious use of personal image data. Ensuring the privacy of such data is the user's responsibility.

Before discarding a data storage device or transferring ownership to another person, erase all data using commercial deletion software, or format the device and then completely refill it with images containing no private information (for example, pictures of empty sky). Be sure to also replace any pictures selected for the **Select an image** option in the **Welcome screen** setting. Care should be taken to avoid injury or damage to property when physically destroying data storage devices.



## AVC Patent Portfolio License

This product is licensed under the AVC Patent Portfolio License for the personal and noncommercial use of a consumer to (i) encode video in compliance with the AVC standard (“AVC video”) and/or (ii) decode AVC video that was encoded by a consumer engaged in a personal and non-commercial activity and/or was obtained from a video provider licensed to provide AVC video. No license is granted or shall be implied for any other use.

Additional information may be obtained from MPEG LA, L.L.C.

See <http://www.mpegla.com>.

## Trademark Information

- Microsoft, Windows and Windows Vista are either registered trademarks or trademarks of Microsoft Corporation in the United States and/or other countries.
- Mac, OS X, the iFrame logo and the iFrame symbol are trademarks or registered trademarks of Apple Inc. in the U.S. and other countries.
- Adobe and Acrobat are registered trademarks of Adobe Systems Inc.

- SDXC, SDHC and SD Logos are trademarks of SD-3C, LLC.



- PictBridge is a trademark.
- HDMI, HDMI logo and High-Definition Multimedia Interface are trademarks or registered trademarks of HDMI Licensing LLC.

## HDMI

- All other trade names mentioned in this manual or the other documentation provided with your Nikon product are trademarks or registered trademarks of their respective holders.

## FreeType License (FreeType2)

Portions of this software are copyright © 2012 The FreeType Project (<http://www.freetype.org>). All rights reserved.

## MIT License (HarfBuzz)

Portions of this software are copyright © 2014 The HarfBuzz Project (<http://www.freedesktop.org/wiki/Software/HarfBuzz>). All rights reserved.

# **Warranty Terms**

## **- Nikon Europe Service Warranty**

Dear Nikon Customer,

We thank you for your purchasing this Nikon product. Should your Nikon product require warranty service, please contact the dealer from whom it was purchased or a member of our authorized service network within the sales territory of Nikon Europe BV (Europe/ Africa and Russia).

In order to avoid any unnecessary inconvenience, we advise you to read the user manuals carefully before contacting the dealer or our authorized service network.

Your Nikon equipment is guaranteed against any manufacturing defects for one full year from the date of original purchase. If during this period of guarantee the product proves defective due to improper material or workmanship, our authorized service network within the sales territory of Nikon Europe BV will, without charge for labor and parts, repair the product in the terms and conditions set as below. Nikon reserves the right (at its sole discretion) to replace or repair the product.

- 1.** This warranty is only provided upon presentation of the completed warranty card and original invoice or purchase receipt indicating the date of purchase, product type and dealer's name, together with the product. Nikon reserves the right to refuse free-of-charge warranty service if the above documents cannot be presented or if the information contained in it is incomplete or illegible.
- 2.** This warranty will not cover:
  - necessary maintenance and repair or replacement of parts due to normal wear and tear.

- modifications to upgrade the product from its normal purpose as described in user manuals, without the prior written consent of Nikon.
  - transport costs and all risks of transport relating directly or indirectly to the warranty of the products.
  - any damage resulting from modifications or adjustments which may be made to the product, without the prior written consent of Nikon, in order to comply with local or national technical standards in force in any other country than the ones for which the product was originally designed and/or manufactured.
3. The warranty will not be applicable in the case of:
- damage caused by misuse including but not limited to failure to use the product for its normal purpose or according to the user instructions on the proper use and maintenance, and to installation or use of the product inconsistent with the safety standards in force in the country where it is used.
  - damage caused by accidents including but not limited to lightning, water, fire, misuse or neglect.
  - defacing, illegibility or removal of the model or serial number on the product.
  - damage resulting from repairs or adjustments which have been conducted by unauthorized service organizations or persons.
  - defects in any system into which the product is incorporated or with which it is used.
4. This service warranty does not affect the consumer's statutory rights under applicable national laws in force, nor the consumer's right against the dealer arising from their sales/purchase contract.

**Notice:** An overview of all authorized Nikon Service Stations can be found online by following this Link (URL = <http://www.europe-nikon.com/service/>).

**NIKON CORPORATION**

---

© 2014 Nikon Corporation

CT3L01(11)  
*6MN34711-01*