

Nikon

DIGITAL CAMERA

COOLPIX S3700



Reference Manual

Introduction	⇒ i
Table of Contents	⇒ xiv
Parts of the Camera	⇒ 1
Preparing for Shooting	⇒ 6
Basic Shooting and Playback Operations	⇒ 11
Shooting Features	⇒ 19
Playback Features	⇒ 50
Recording and Playing Back Movies	⇒ 60
Using Menus	⇒ 64
Using the Wi-Fi (Wireless LAN) Function	⇒ 100
Connecting the Camera to a TV, Printer, or Computer	⇒ 104
Technical Notes	⇒ 113

Introduction



Read This First

To get the most from this Nikon product, be sure to read “For Your Safety” (📖vi–viii) and “Wi-Fi (Wireless LAN Network)” (📖xi), and all other instructions thoroughly and keep them where they will be read by all who use the camera.

- If you want to start using the camera right away, see “Preparing for Shooting” (📖6) and “Basic Shooting and Playback Operations” (📖11).

Other Information

- Symbols and Conventions

Symbol	Description
	This icon marks cautions and information that should be read before using the camera.
	This icon marks notes and information that should be read before using the camera.
	This icon marks other pages containing relevant information.

- SD, SDHC, and SDXC memory cards are referred to as “memory cards” in this manual.
- The setting at the time of purchase is referred to as the “default setting.”
- The names of menu items displayed in the camera monitor, and the names of buttons or messages displayed on a computer monitor appear in bold.
- In this manual, images are sometimes omitted from monitor display samples so that monitor indicators can be more clearly shown.

How to Attach the Camera Strap

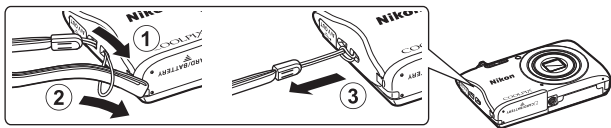

Information and Precautions

Life-Long Learning

As part of Nikon's "Life-Long Learning" commitment to ongoing product support and education, continually updated information is available online at the following websites:

- For users in the U.S.A.: <http://www.nikonusa.com/>
- For users in Europe: <http://www.europe-nikon.com/support/>
- For users in Asia, Oceania, the Middle East, and Africa: <http://www.nikon-asia.com/>

Visit these websites to keep up-to-date with the latest product information, tips, answers to frequently asked questions (FAQs), and general advice on digital imaging and photography. Additional information may be available from the Nikon representative in your area. Visit the website below for contact information.

<http://imaging.nikon.com/>

Use Only Nikon Brand Electronic Accessories

Nikon COOLPIX cameras are designed to the highest standards and include complex electronic circuitry. Only Nikon brand electronic accessories (including battery chargers, batteries, Charging AC Adapter, and AC adapters) certified by Nikon specifically for use with this Nikon digital camera are engineered and proven to operate within the operational and safety requirements of this electronic circuitry.

THE USE OF NON-NIKON ELECTRONIC ACCESSORIES COULD DAMAGE THE CAMERA AND MAY VOID YOUR NIKON WARRANTY.

The use of third-party rechargeable Li-ion batteries not bearing the Nikon holographic seal could interfere with normal operation of the camera or result in the batteries overheating, igniting, rupturing, or leaking.

Holographic seal: Identifies this device as an authentic Nikon product.



For more information about Nikon brand accessories, contact a local authorized Nikon dealer.

Before Taking Important Pictures

Before taking pictures on important occasions (such as at weddings or before taking the camera on a trip), take a test shot to ensure that the camera is functioning normally. Nikon will not be held liable for damages or lost profits that may result from product malfunction.

About the Manuals

- No part of the manuals included with this product may be reproduced, transmitted, transcribed, stored in a retrieval system, or translated into any language in any form, by any means, without Nikon's prior written permission.
- Illustrations and monitor content shown in this manual may differ from the actual product.
- Nikon reserves the right to change the specifications of the hardware and software described in these manuals at any time and without prior notice.
- Nikon will not be held liable for any damages resulting from the use of this product.
- While every effort was made to ensure that the information in these manuals is accurate and complete, we would appreciate it were you to bring any errors or omissions to the attention of the Nikon representative in your area (address provided separately).

Notice Concerning Prohibition of Copying or Reproduction

Note that simply being in possession of material that was digitally copied or reproduced by means of a scanner, digital camera or other device may be punishable by law.

• **Items prohibited by law from being copied or reproduced**

Do not copy or reproduce paper money, coins, securities, government bonds or local government bonds, even if such copies or reproductions are stamped "Sample." The copying or reproduction of paper money, coins, or securities which are circulated in a foreign country is prohibited. Unless the prior permission of the government was obtained, the copying or reproduction of unused postage stamps or post cards issued by the government is prohibited.

The copying or reproduction of stamps issued by the government and of certified documents stipulated by law is prohibited.

• **Cautions on certain copies and reproductions**

The government has issued cautions on copies or reproductions of securities issued by private companies (shares, bills, checks, gift certificates, etc.), commuter passes, or coupon tickets, except when a minimum of necessary copies are to be provided for business use by a company. Also, do not copy or reproduce passports issued by the government, licenses issued by public agencies and private groups, ID cards and tickets, such as passes and meal coupons.

• **Comply with copyright notices**

The copying or reproduction of copyrighted creative works such as books, music, paintings, woodcut prints, maps, drawings, movies, and photographs is governed by national and international copyright laws. Do not use this product for the purpose of making illegal copies or to infringe copyright laws.

Disposing of Data Storage Devices

Please note that deleting images or formatting data storage devices such as memory cards or built-in camera memory does not completely erase the original image data. Deleted files can sometimes be recovered from discarded storage devices using commercially available software, potentially resulting in the malicious use of personal image data. Ensuring the privacy of such data is the user's responsibility.

Before discarding a data storage device or transferring ownership to another person, erase all data using commercial deletion software, or format the device and then completely refill it with images containing no private information (for example, images of empty sky). Care should be taken to avoid injury or damage to property when physically destroying data storage devices.

To delete the Wi-Fi settings, select **Restore default settings** in the Wi-Fi options menu (📖64).

Conformity Marking

Follow the procedure below to display some of the conformity markings that the camera complies with.

Press the **MENU** button → 🍷 menu icon → Conformity marking → Ⓞ button

For Your Safety

To prevent damage to your Nikon product or injury to yourself or to others, read the following safety precautions in their entirety before using this equipment. Keep these safety instructions where all those who use the product will read them.

The consequences that could result from failure to observe the precautions listed in this section are indicated by the following symbol:



This icon marks warnings, information that should be read before using this Nikon product, to prevent possible injury.

WARNINGS

Turn off in the event of malfunction

Should you notice smoke or an unusual smell coming from the camera or Charging AC Adapter, unplug the Charging AC Adapter and remove the battery immediately, taking care to avoid burns. Continued operation could result in injury. After removing or disconnecting the power source, take the equipment to a Nikon-authorized service representative for inspection.

Do not disassemble

Touching the internal parts of the camera or Charging AC Adapter could result in injury. Repairs should be performed only by qualified technicians. Should the camera or Charging AC Adapter break open as the result of a fall or other accident, take the product to a Nikon-authorized service representative for inspection, after unplugging the product and/or removing the battery.

Do not use the camera or Charging AC Adapter in the presence of flammable gas

Do not use electronic equipment in the presence of flammable gas, as this could result in explosion or fire.

Handle the camera strap with care

Never place the strap around the neck of an infant or child.

Keep out of reach of children

Particular care should be taken to prevent infants from putting the battery or other small parts into their mouths.

 **Do not remain in contact with the camera, Charging AC Adapter, or AC adapter for extended periods while the devices are on or in use**

Parts of the devices become hot. Leaving the devices in direct contact with the skin for extended periods may result in low-temperature burns.

 **Do not leave the product where it will be exposed to extremely high temperatures, such as in an enclosed automobile or in direct sunlight**

Failure to observe this precaution could cause damage or fire.

 **Observe caution when handling the battery**

The battery may leak, overheat, or explode if improperly handled. Observe the following precautions when handling the battery for use in this product:

- Before replacing the battery, turn the product off. If you are using the Charging AC Adapter/AC adapter, be sure it is unplugged.
- Use only a Rechargeable Li-ion Battery EN-EL19 (included). Charge the battery by using a camera that supports battery charging. To perform this operation, use either Charging AC Adapter EH-70P/EH-70PCH/EH-72P/EH-72PCH (included) or the **Charge by computer** function. The Battery Charger MH-66 (available separately) is also available to charge the battery without using a camera.
- When inserting the battery, do not attempt to insert it upside down or backwards.
- Do not short or disassemble the battery or attempt to remove or break the battery insulation or casing.
- Do not expose the battery to flame or to excessive heat.
- Do not immerse in or expose to water.
- Put the battery in a plastic bag, etc. in order to insulate it before transporting. Do not transport or store with metal objects such as necklaces or hairpins.
- The battery is prone to leakage when fully discharged. To avoid damage to the product, be sure to remove the battery when no charge remains.
- Discontinue use immediately should you notice any change in the battery, such as discoloration or deformation.
- If liquid from the damaged battery comes in contact with clothing or skin, rinse immediately with plenty of water.

 **Observe the following precautions when handling the Charging AC Adapter**

- Keep dry. Failure to observe this precaution could result in fire or electric shock.
- Dust on or near the metal parts of the plug should be removed with a dry cloth. Continued use could result in fire.
- Do not handle the plug or go near the Charging AC Adapter during lightning storms. Failure to observe this precaution could result in electric shock.

- Do not damage, modify, forcibly tug or bend the USB cable, place it under heavy objects, or expose it to heat or flames. Should the insulation be damaged and the wires become exposed, take it to a Nikon-authorized service representative for inspection. Failure to observe these precautions could result in fire or electric shock.
- Do not handle the plug or Charging AC Adapter with wet hands. Failure to observe this precaution could result in electric shock.
- Do not use with travel converters or adapters designed to convert from one voltage to another or with DC-to-AC inverters. Failure to observe this precaution could damage the product or cause overheating or fire.

 **Use appropriate cables**

When connecting cables to the input and output jacks, use only the cables provided or sold by Nikon for the purpose, to maintain compliance with product regulations.

 **Do not touch the moving parts of the lens**

Failure to observe this precaution could result in injury.

 **Handle moving parts with care**

Be careful that your fingers or other objects are not pinched by the lens cover or other moving parts.

 **Using the flash close to your subject's eyes could cause temporary visual impairment**

The flash should be no less than 1 meter (3 ft 4 in.) from the subject. Particular care should be observed when photographing infants.

 **Do not operate the flash with the flash window touching a person or object**

Failure to observe this precaution could result in burns or fire.

 **Avoid contact with liquid crystal**

Should the monitor break, care should be taken to avoid injury caused by broken glass and to prevent liquid crystal from the monitor touching the skin or entering the eyes or mouth.

 **Follow the instructions of airline and hospital personnel**

Notices

Notices for Customers in the U.S.A.

IMPORTANT SAFETY INSTRUCTIONS - SAVE THESE INSTRUCTIONS.

DANGER - TO REDUCE THE RISK OF FIRE OR ELECTRIC SHOCK, CAREFULLY FOLLOW THESE INSTRUCTIONS

For connection to a supply not in the U.S.A., use an attachment plug adapter of the proper configuration for the power outlet if needed.

The power supply unit is intended to be correctly orientated in a vertical or floor mount position.

Federal Communications Commission (FCC) Radio Frequency Interference Statement

This equipment has been tested and found to comply with the limits for a Class B digital device, pursuant to Part 15 of the FCC rules. These limits are designed to provide reasonable protection against harmful

interference in a residential installation. This equipment generates, uses, and can radiate radio frequency energy and, if not installed and used in accordance with the instructions, may cause harmful interference to radio communications. However, there is no guarantee that interference will not occur in a particular installation. If this equipment does cause harmful interference to radio or television reception, which can be determined by turning the equipment off and on, the user is encouraged to try to correct the interference by one or more of the following measures:

- Reorient or relocate the receiving antenna.
- Increase the separation between the equipment and receiver.
- Connect the equipment into an outlet on a circuit different from that to which the receiver is connected.
- Consult the dealer or an experienced radio/television technician for help.



CAUTIONS

Modifications

The FCC requires the user to be notified that any changes or modifications made to this device that are not expressly approved by Nikon Corporation may void the user's authority to operate the equipment.

Interface Cables

Use the interface cables sold or provided by Nikon for your equipment. Using other interface cables may exceed the limits of Class B Part 15 of the FCC rules.

Notice for Customers in the State of California

WARNING

Handling the cord on this product will expose you to lead, a chemical known to the State of California to cause birth defects or other reproductive harm.

Wash hands after handling.

Nikon Inc.,

1300 Walt Whitman Road, Melville, New York 11747-3064, U.S.A.

Tel: 631-547-4200

Notice for Customers in Canada

CAN ICES-3(B) / NMB-3(B)

Notices for Customers in Europe

CAUTIONS

RISK OF EXPLOSION IF BATTERY IS REPLACED BY AN INCORRECT TYPE.

DISPOSE OF USED BATTERIES ACCORDING TO THE INSTRUCTIONS.

This symbol indicates that electrical and electronic equipment is to be collected separately.

The following apply only to users in European countries:

- This product is designated for separate collection at an appropriate collection point. Do not dispose of as household waste.
- Separate collection and recycling helps conserve natural resources and prevent negative consequences for human health and the environment that might result from incorrect disposal.
- For more information, contact the retailer or the local authorities in charge of waste management.



This symbol on the battery indicates that the battery is to be collected separately.

The following apply only to users in European countries:

- All batteries, whether marked with this symbol or not, are designated for separate collection at an appropriate collection point. Do not dispose of as household waste.
- For more information, contact the retailer or the local authorities in charge of waste management.



Wi-Fi (Wireless LAN Network)

This product is controlled by the United States Export Administration Regulations, and you are required to obtain permission from the United States government if you export or re-export this product to any country to which the United States embargoes goods. The following countries were subject to embargo: Cuba, Iran, North Korea, Sudan, and Syria. Since the target countries are subject to change, please contact the United States Department of Commerce for the latest information.

Restrictions on Wireless Devices

The wireless transceiver included in this product conforms to wireless regulations in the country of sale and is not for use in other countries (products purchased in the EU or EFTA can be used anywhere within the EU and EFTA). Nikon does not accept liability for use in other countries. Users who are unsure as to the original country of sale should consult with their local Nikon service center or Nikon-authorized service representative. This restriction applies to wireless operation only and not to any other use of the product.

Notice for Customers in the U.S.A. and Canada

Federal Communications Commission (FCC) and Industry of Canada (IC)

Declaration of Conformity

This device complies with Part 15 of FCC Rules and Industry Canada licence-exempt RSS standard(s). Operation is subject to the following two conditions: (1) this device may not cause interference, and (2) this device must accept any interference, including interference that may cause undesired operation of this device.

FCC/IC RF Exposure Statement

This transmitter must not be co-located or operated in conjunction with any other antenna or transmitter.

The available scientific evidence does not show that any health problems are associated with using low power wireless devices. There is no proof, however, that these low power wireless devices are absolutely safe. Low power wireless devices emit low levels of radio frequency energy (RF) in the microwave range while being used. Whereas high levels of RF can produce health effects (by heating tissue), exposure of low-level RF that does not produce heating effects causes no known adverse health effects. Many studies of low-level RF exposures have not found any biological effects. Some studies have suggested that some biological effects might occur, but such findings have not been confirmed by additional research.

COOLPIX S3700, which is equipped with a WSDB-686GN (FCC ID:2AAD3AA1G0J0 / IC ID:4634A-2150EC) Wireless LAN Module, has been tested and found to comply with FCC/IC radiation exposure limits set forth for an uncontrolled environment and meets the FCC radio frequency (RF) Exposure Guidelines in Supplement C to OET65 and RSS-102 of the IC radio frequency (RF) Exposure rules. Please refer to the SAR test report that was uploaded to FCC website.

Declaration of Conformity (Europe)

Hereby, Nikon Corporation, declares that COOLPIX S3700 is in compliance with the essential requirements and other relevant provisions of Directive 1999/5/EC. The declaration of conformity may be consulted at http://imaging.nikon.com/support/pdf/DoC_S3700.pdf.

Notice for Customers in Jamaica

This product contains a Type Approved Module by Jamaica: "SMA – WSDB-686GN"

Precautions when Using Radio Transmissions



Always keep in mind that radio transmission or reception of data is subject to interception by third parties. Note that Nikon is not responsible for data or information leaks that may occur during data transfer.

Personal Information Management and Disclaimer

- User information registered and configured on the product, including wireless LAN connection settings and other personal information, is susceptible to alteration and loss resulting from operational error, static electricity, accident, malfunction, repair or other handling. Always keep separate copies of important information. Nikon is not responsible for any direct or indirect damages or lost profits resulting from alteration or loss of content that is not attributable to Nikon.
- Before discarding this product or transferring it to another owner, perform **Reset all** in the setup menu (📖64) to delete all user information registered and configured with the product, including wireless LAN connection settings and other personal information.

Table of Contents

Introduction	i
Read This First	i
Other Information.....	i
How to Attach the Camera Strap.....	ii
Information and Precautions.....	iii
For Your Safety	vi
WARNINGS.....	vi
Notices.....	ix
Wi-Fi (Wireless LAN Network).....	xi
<hr/>	
Parts of the Camera	1
The Camera Body.....	1
The Monitor	3
Shooting Mode	3
Playback Mode	5
<hr/>	
Preparing for Shooting.....	6
Insert the Battery and Memory Card	6
Removing the Battery or Memory Card.....	6
Memory Cards and Internal Memory.....	6
Charge the Battery	7
Turn the Camera On and Set the Display Language, Date, and Time	9
<hr/>	
Basic Shooting and Playback Operations.....	11
Shooting with Scene Auto Selector Mode.....	11
Using the Zoom.....	13
The Shutter-release Button.....	13
Play Back Images.....	14
Delete Images	15
Changing the Shooting Mode	17
Using the Flash, Self-timer, Etc.....	18
Recording Movies.....	18
<hr/>	
Shooting Features.....	19
 (Scene Auto Selector) Mode.....	19
Scene Mode (Shooting Suited to Scenes).....	20
Tips and Notes.....	21
Shooting with Panorama Assist	24

Playback with Panorama Assist	26
Special Effects Mode (Applying Effects When Shooting)	27
Smart Portrait Mode (Enhancing Human Faces When Shooting)	29
Using Smile Timer	30
Using Self-Collage	31
 (Auto) Mode	33
Using the Creative Slider	33
Flash Mode	35
Self-timer	37
Macro Mode (Taking Close-up Pictures)	39
Exposure Compensation (Adjusting Brightness)	40
Default Settings (Flash, Self-timer, Etc.)	41
Focusing	43
Using Face Detection	43
Using Skin Softening	44
Using Target Finding AF	45
Subjects Not Suitable for Autofocus	46
Focus Lock	47
Functions That Cannot Be Used Simultaneously When Shooting	48
<hr/>	
Playback Features	50
Playback Zoom	50
Thumbnail Playback/Calendar Display	51
List by Date Mode	52
Editing Images (Still Images)	53
Before Editing Images	53
Quick Effects: Changing Hue or Mood	53
Quick Retouch: Enhancing Contrast and Saturation	54
D-Lighting: Enhancing Brightness and Contrast	55
Red-eye Correction: Correcting Red-eye When Shooting with the Flash	55
Glamour Retouch: Enhancing Human Faces	56
Small Picture: Reducing the Size of an Image	58
Crop: Creating a Cropped Copy	59
<hr/>	
Recording and Playing Back Movies	60
Operations During Movie Playback	63
<hr/>	
Using Menus	64
The Shooting Menu (for  (Auto) Mode)	66
Image Mode (Image Size and Quality)	66
White Balance (Adjusting Hue)	68

Continuous Shooting	70
ISO Sensitivity	71
AF Area Mode	72
Autofocus Mode	75
The Smart Portrait Menu	76
Self-Collage	76
Blink Proof	77
The Playback Menu	78
Mark for Wi-Fi Upload	78
Slide Show	79
Protect	80
Rotate Image	80
Copy (Copy Between the Memory Card and Internal Memory)	81
The Image Selection Screen	82
The Movie Menu	83
Movie Options	83
Autofocus Mode	84
Movie VR	85
Wind Noise Reduction	85
The Wi-Fi Options Menu	86
Operating the Text Input Keyboard	87
The Setup Menu	88
Time Zone and Date	88
Monitor Settings	90
Date Stamp	92
Photo VR	93
AF Assist	94
Digital Zoom	94
Sound Settings	95
Auto Off	95
Format Card/Format Memory	96
Language	97
Video Mode	97
Charge by Computer	98
Reset All	99
Conformity Marking	99
Firmware Version	99
Using the Wi-Fi (Wireless LAN) Function	100
Installing the Software on the Smart Device	100
Connecting the Smart Device to the Camera	101

Preselecting Images in the Camera That You Want to Transfer to a Smart Device	103
<hr/>	
Connecting the Camera to a TV, Printer, or Computer	104
Connecting the Camera to a TV (Playback on a TV)	106
Connecting the Camera to a Printer (Direct Print).....	107
Connecting the Camera to a Printer	107
Printing Images One at a Time	108
Printing Multiple Images	109
Using ViewNX 2 (Transferring Images to a Computer)	111
Installing ViewNX 2	111
Transferring Images to a Computer	111
<hr/>	
Technical Notes.....	113
Caring for the Product	114
The Camera.....	114
The Battery	115
The Charging AC Adapter.....	116
Memory Cards.....	117
Cleaning and Storage.....	118
Cleaning.....	118
Storage	118
Error Messages.....	119
Troubleshooting	123
File Names	130
Optional Accessories	131
Specifications	132
Approved Memory Cards.....	137
Index.....	139



A series of horizontal dashed lines spanning the width of the page, intended for handwriting practice.

Parts of the Camera

The Camera Body

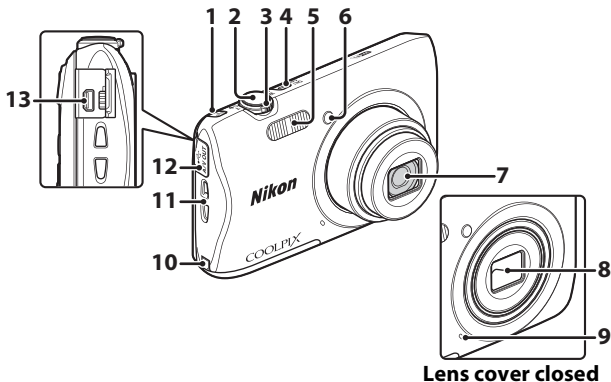

1	(Wi-Fi) button.....	101	7	Lens	
2	Shutter-release button.....	12	8	Lens cover	
	Zoom control.....	13	9	Built-in microphone	
	W : Wide-angle.....	13		Power connector cover (for	
3	T : Telephoto.....	13	10	connection with optional AC	
	Thumbnail playback.....	51		adapter)	
	Playback zoom.....	50	11	Eyelet for camera strap.....	ii
	Help.....	20	12	Connector cover.....	104
4	Power switch/power-on lamp.....	9	13	USB/audio/video output	
5	Flash.....	35		connector.....	104
6	Self-timer lamp.....	38			
	AF-assist illuminator				

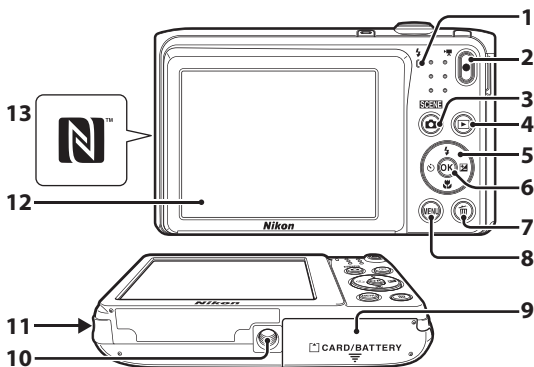

- | | | | |
|----------|---|-----------|---|
| 1 | Charge lamp.....7 | 8 | MENU (menu) button..... 64 |
| | Flash lamp.....35 | 9 | Battery-chamber/
memory card slot cover6 |
| 2 | ● (movie-record) button.....18 | 10 | Tripod socket 134 |
| 3 | 📷 (shooting mode) button
.....17, 20, 27, 29, 33 | 11 | Speaker |
| 4 | ▶ (playback) button14 | 12 | Monitor.....3 |
| 5 | Multi selector64 | 13 | N-Mark (NFC antenna)..... 102 |
| 6 | Ⓞ (apply selection) button.....64 | | |
| 7 | 🗑 (delete) button15 | | |

The Monitor

The information that is displayed in the monitor during shooting and playback changes depending on the camera's settings and state of use.

By default, information is displayed when the camera is turned on and when you operate the camera, and turns off after a few seconds (when **Photo info** is set to **Auto info** in **Monitor settings** (📖90)).

Shooting Mode

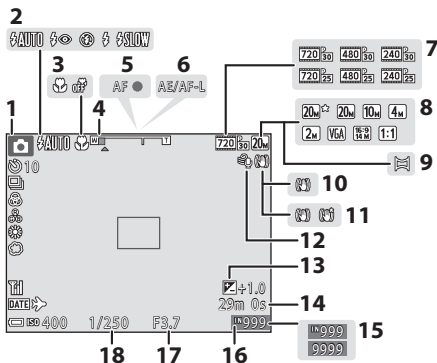

1	Shooting mode	17, 20, 27, 29, 33	11	Movie VR icon.....	85
2	Flash mode.....	35	12	Wind noise reduction.....	85
3	Macro mode.....	39	13	Exposure compensation value	40
4	Zoom indicator.....	13, 39	14	Remaining movie recording time	18
5	Focus indicator.....	12	15	Number of exposures remaining	10
6	AE/AF-L indicator.....	25	16	(still images).....	10
7	Movie options.....	83	17	Internal memory indicator.....	10
8	Image mode.....	66	18	Aperture value.....	13
9	Panorama assist.....	24		Shutter speed.....	13
10	Photo VR icon.....	93			

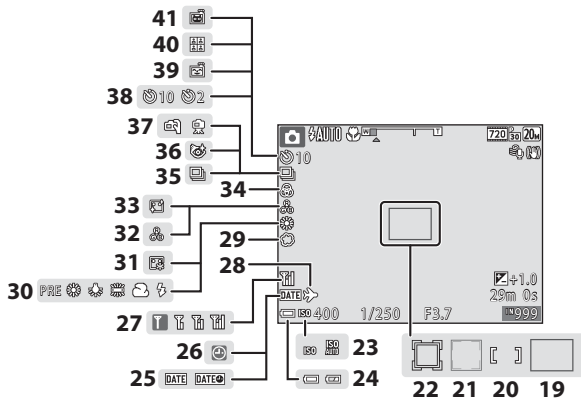

19	Focus area (target finding AF)	45, 73	29	Soft	29
20	Focus area (manual or center)	47, 72	30	White balance	68
21	Focus area (face detection, pet detection)	23, 29, 43, 72	31	Foundation makeup	29
22	Focus area (subject tracking)	73, 74	32	Hue	33
23	ISO sensitivity	71	33	Skin softening	29
24	Battery level indicator	10	34	Vividness	29, 33
25	Date stamp	92	35	Continuous shooting mode	70
26	"Date not set" indicator	124	36	Blink proof icon	77
27	Wi-Fi communication indicator	101	37	Hand-held/tripod	21
28	Travel destination icon	88	38	Self-timer indicator	37
			39	Smile timer	30
			40	Self-Collage	31
			41	Pet portrait auto release	23

Playback Mode

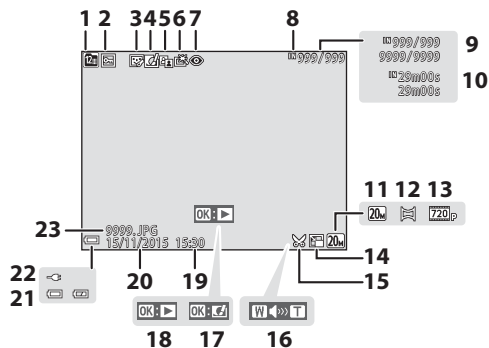

1	List by date icon	52	13	Movie options	83
2	Protect icon	80	14	Small picture icon	58
3	Glamour retouch icon	56	15	Crop icon	50, 59
4	Quick effects icon	53	16	Volume indicator	63
5	D-Lighting icon	55	17	Quick effects guide	
6	Quick retouch icon	54	18	Panorama assist playback guide	
7	Red-eye correction icon	55		Movie playback guide	
8	Internal memory indicator		19	Time of recording	
9	Current image number/ total number of images		20	Date of recording	
10	Movie length or elapsed playback time		21	Battery level indicator	10
11	Image mode	66	22	Charging AC Adapter connection indicator	
12	Panorama assist	24	23	File number and type	130

Preparing for Shooting

Insert the Battery and Memory Card

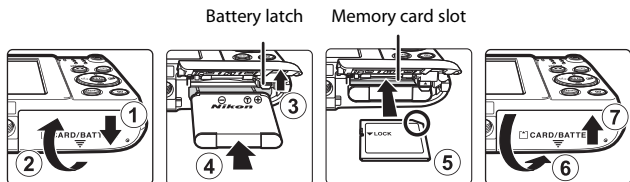

- With the battery's positive and negative terminals oriented correctly, move the orange battery latch (3), and fully insert the battery (4).
- Slide the memory card in until it clicks into place (5).
- Be careful not to insert the battery or memory card upside-down or backward, as this could cause a malfunction.

Formatting a Memory Card

The first time you insert a memory card that has been used in another device into this camera, make sure to format it with this camera. Insert the memory card into the camera, press the **MENU** button, and select **Format card** in the setup menu (64).

Removing the Battery or Memory Card

Turn the camera off and make sure that the power-on lamp and monitor have turned off, and then open the battery-chamber/memory card slot cover.

- Move the battery latch to eject the battery.
- Gently push the memory card into the camera to partially eject the memory card.
- Be careful when handling the camera, battery, and memory card immediately after using the camera, as they may become hot.

Memory Cards and Internal Memory

Camera data, including images and movies, can be saved either on a memory card or in the camera's internal memory. To use the camera's internal memory, remove the memory card.

Charge the Battery

- 1 With the battery installed, connect the camera to an electrical outlet.

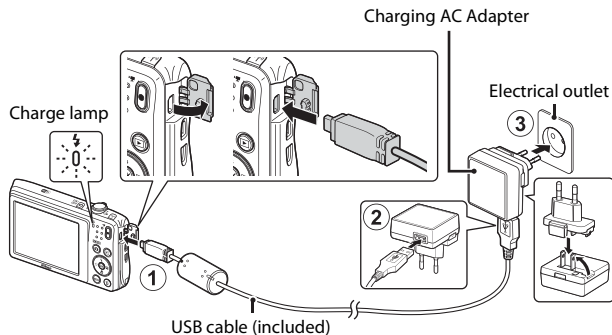

If a plug adapter* is included with your camera, securely connect it to the Charging AC Adapter. Once the two are connected, attempting to forcibly remove the plug adapter could damage the product.

- * The shape of the plug adapter varies according to the country or region in which the camera was purchased. This step can be omitted if the plug adapter comes permanently bonded to the Charging AC Adapter.
- The charge lamp slowly flashes green to indicate that the battery is charging.
- When charging is complete, the charge lamp turns off. It takes about 2 hours 40 minutes to charge a fully exhausted battery.
- The battery cannot be charged when the charge lamp quickly flashes green, possibly due to one of the reasons described below.
 - The ambient temperature is not suited to charging.
 - The USB cable or Charging AC Adapter is not properly connected.
 - The battery is damaged.

- 2 Disconnect the Charging AC Adapter from the electrical outlet and then disconnect the USB cable.

Notes About the USB Cable

Make sure that the plugs are properly oriented. Do not insert or remove the plugs at an angle when connecting or disconnecting them.

Turning the Camera On While Charging

If you press the power switch while charging with the Charging AC Adapter, the camera turns on in playback mode, and captured images can be played back. Shooting is not possible.

Charging Using a Computer or Battery Charger

- You can also charge the battery by connecting the camera to a computer.
- You can use the Battery Charger MH-66 (available separately) to charge the battery without using the camera.

Turn the Camera On and Set the Display Language, Date, and Time

When the camera is turned on for the first time, the language-selection screen and the date and time setting screen for the camera clock are displayed.

1 Press the power switch to turn on the camera.

- The monitor turns on.
- To turn the camera off, press the power switch again.

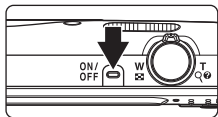

2 Use the multi selector ▲▼ to select the desired language and press the OK button.

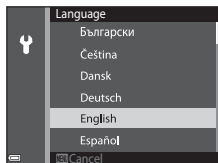

3 Select **Yes** and press the OK button.

4 Select your home time zone and press the OK button.

- Press ▲ to display  above the map and enable daylight saving time. Press ▼ to disable it.

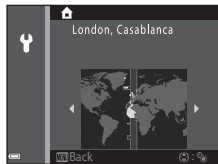

5 Use ▲▼ to select the date format and press the OK button.

6 Set the date and time, and press the **OK** button.

- Use **◀▶** to select a field and then use **▲▼** to set the date and time.
- Select the minute field and press the **OK** button to confirm the setting.

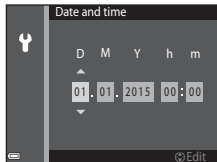

7 When the confirmation dialog is displayed, use **▲▼** to select **Yes** and press the **OK** button.

- When settings are finished, the lens extends.
- The shooting screen is displayed, and you can take pictures in scene auto selector mode.
- Battery level indicator
 - : The battery level is high.
 - : The battery level is low.
- Number of exposures remaining
 - is displayed when no memory card is inserted in the camera, and images are saved in the internal memory.

Number of exposures remaining



Battery level indicator

Changing the Language or the Date and Time Setting

- You can change these settings using the **Language** and **Time zone and date** settings in the **Y** setup menu (64).
- You can enable or disable daylight saving time in the **Y** setup menu by selecting **Time zone and date** followed by **Time zone**. Press the multi-selector **▶** and then **▲** to enable daylight saving time and move the clock forward one hour, or **▼** to disable daylight saving time and move the clock back one hour.

The Clock Battery

- The camera's clock is powered by a built-in backup battery. The backup battery charges when the main battery is inserted into the camera or when the camera is connected to an optional AC adapter, and it can run the clock for several days after about 10 hours of charging.
- If the camera's backup battery becomes exhausted, the date and time setting screen is displayed when the camera is turned on. Set the date and time again (9).

Basic Shooting and Playback Operations

Shooting with Scene Auto Selector Mode

1 Hold the camera steady.

- Keep fingers and other objects away from the lens, flash, AF assist-illuminator, microphone, and speaker.
- When taking pictures in portrait ("tall") orientation, turn the camera so that the flash is above the lens.

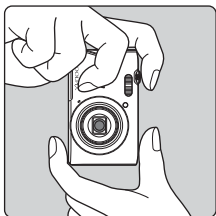
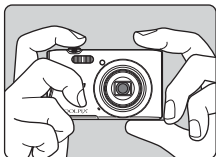

2 Frame the picture.

- Move the zoom control to change the zoom lens position.
- When the camera recognizes the shooting scene, the shooting mode icon changes accordingly.

Zoom out Zoom in

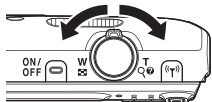

Shooting mode icon

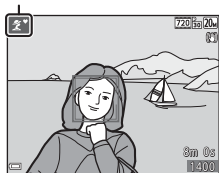

3 Press the shutter-release button halfway.

- When the subject is in focus, the focus area or focus indicator is displayed in green.
- When you are using digital zoom, the camera focuses in the center of the frame and the focus area is not displayed.
- If the focus area or focus indicator flashes, the camera is unable to focus. Modify the composition and try pressing the shutter-release button halfway again.

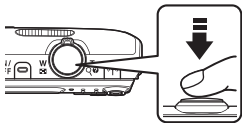

4 Without lifting your finger, press the shutter-release button the rest of the way down.



✓ Notes About Saving Images or Movies

The indicator showing the number of exposures remaining or the indicator showing the remaining recording time flashes while images or movies are being saved. **Do not open the battery-chamber/memory card slot cover or remove the battery or memory card** while an indicator is flashing. Doing this could result in loss of data, or in damage to the camera or the memory card.

📎 The Auto Off Function

- When no operations are performed for about one minute, the monitor turns off, the camera enters standby mode, and then the power-on lamp flashes. The camera turns off after remaining in standby mode for about three minutes.
- To turn the monitor back on while the camera is in standby mode, perform an operation such as pressing the power switch or shutter-release button.

📎 When Using a Tripod

- We recommend using a tripod to stabilize the camera in the following situations:
 - When shooting in dim lighting with the flash mode (📖18) set to Ⓡ (off)
 - When the zoom is at a telephoto position
- When using a tripod to stabilize the camera during shooting, set **Photo VR** to **Off** in the setup menu (📖64) to prevent potential errors caused by this function.

Using the Zoom

When you move the zoom control, the zoom lens position changes.

- To zoom in: Move toward **T**
- To zoom out: Move toward **W**

When you turn the camera on, the zoom moves to the maximum wide-angle position.

- A zoom indicator is displayed on the shooting screen when the zoom control is moved.
- Digital zoom, which allows you to further magnify the subject up to approximately 4x the maximum optical zoom ratio, can be activated by moving and holding the zoom control toward **T** when the camera is zoomed in to the maximum optical zoom position.

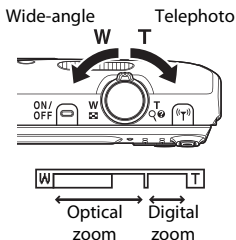



Digital Zoom

The zoom indicator changes to blue when the digital zoom is activated, and it changes to yellow when the zoom magnification is increased further.

- Zoom indicator is blue: Image quality is not noticeably reduced by using the Dynamic Fine Zoom.
- Zoom indicator is yellow: There may be cases in which image quality is noticeably reduced.
- The indicator remains blue across a wider area when the image size is smaller.
- The zoom indicator may not change to blue when using certain continuous shooting settings or other settings.

The Shutter-release Button

<p>Press halfway</p> 	<p>To set focus and exposure (shutter speed and aperture value), press the shutter-release button lightly until you feel a slight resistance. Focus and exposure remain locked while the shutter-release button is pressed halfway.</p>
<p>Press all the way</p> 	<p>Press the shutter-release button all the way to release the shutter and take a picture. Do not use force when pressing the shutter-release button, as this may result in camera shake and blurred images. Press the button gently.</p>

Play Back Images

- 1** Press the  (playback) button to enter playback mode.

- If you press and hold down the  button while the camera is turned off, the camera turns on in playback mode.





- 2** Use the multi selector to select an image to display.

- Press and hold down  to scroll through the images quickly.
- To return to shooting mode, press the  button or shutter-release button.

Display the previous image



Display the next image

- When  is displayed in full-frame playback mode, you can press the  button to apply an effect to the image.



- Move the zoom control toward **T** () in full-frame playback mode to zoom in on an image.



- In full-frame playback mode, move the zoom control toward **W** () to switch to thumbnail playback mode and display multiple images on the screen.



Delete Images

- 1 Press the  (delete) button to delete the image currently displayed in the monitor.



- 2 Use the multi selector   to select the desired deletion method and press the  button.
 - To exit without deleting, press the **MENU** button.

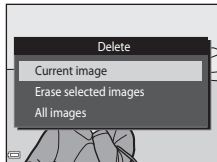

- 3 Select **Yes** and press the  button.
 - Deleted images cannot be recovered.

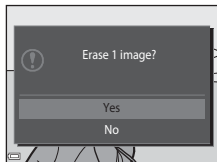

Deleting the Image Captured While in Shooting Mode

When using shooting mode, press the  button to delete the last image that was saved.

Operating the Erase Selected Images Screen

1 Use the multi selector ◀▶ to select an image to be deleted, and then use ▲ to display 🗑️.

- To undo the selection, press ▼ to remove 🗑️.
- Move the zoom control (📖1) toward **T** (🔍) to switch to full-frame playback or **W** (📐) to switch to thumbnail playback.



2 Add 🗑️ to all images that you want to delete and then press the Ⓞ button to confirm the selection.

- A confirmation dialog is displayed. Follow the on-screen instructions to complete operations.



Changing the Shooting Mode



The shooting modes described below are available.

- **SCN Scene auto selector**
The camera automatically recognizes the shooting scene when you frame a picture, making it easier to take pictures using settings that suit the scene.
- **SO Scene mode**
Camera settings are optimized according to the scene that you select.
- **SO Special effects**
Effects can be applied to images during shooting.
- **Smart portrait**
Use glamour retouch to enhance human faces during shooting, and use the smile timer or self-collage function to take pictures.
- **Auto mode**
Used for general shooting. Settings can be changed to suit the shooting conditions and the type of shot that you want to capture.

- 1** When the shooting screen is displayed, press the  (shooting mode) button.



- 2** Use the multi selector   to select a shooting mode and press the  button.

- When scene mode or special effects mode is selected, press  to select a scene mode or effect before pressing the  button.

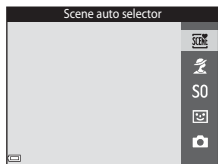

Using the Flash, Self-timer, Etc.

When the shooting screen is displayed, you can press the multi selector ▲ (⚡) ◀ (⌚) ▼ (🌸) ▶ (📷) to set the functions described below.



- **⚡ Flash mode**
You can select a flash mode to match the shooting conditions.
- **⌚ Self-timer**
The camera releases the shutter 10 seconds or 2 seconds after you press the shutter-release button.
- **🌸 Macro mode**
Use macro mode when you take close-up pictures.
- **📷 Exposure compensation**
You can adjust overall image brightness.

The functions that can be set vary depending on the shooting mode.

Recording Movies

Display the shooting screen and press the ● (▶) (movie-record) button to start recording a movie. Press the ● (▶) (movie-record) button again to end recording.

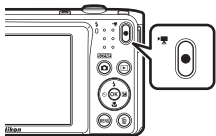

- To play back a movie, select a movie in full-frame playback mode and press the Ⓞ (OK) button.













Shooting Features

(Scene Auto Selector) Mode

The camera automatically recognizes the shooting scene when you frame a picture, making it easier to take pictures using settings that suit the scene.

Enter shooting mode →  (shooting mode) button →  (scene auto selector) mode →  button

When the camera automatically recognizes the shooting scene, the shooting mode icon displayed on the shooting screen changes accordingly.

	Portrait (for taking close-up portraits of one or two people)
	Portrait (for taking portraits of large numbers of people, or images in which the background takes up a large portion of the frame)
	Landscape
	Night portrait (for taking close-up portraits of one or two people)
	Night portrait (for taking portraits of large numbers of people, or images in which the background takes up a large portion of the frame)
	Night landscape
	Close-up
	Backlighting (for taking pictures of subjects other than people)
	Backlighting (for taking portrait pictures)
	Other scenes

Notes About (Scene Auto Selector) Mode





- Depending on shooting conditions, the camera may not select the desired scene mode. In this case, select another shooting mode ([17](#)).
- When the digital zoom is in effect, the shooting mode icon changes to .

Functions Available in (Scene Auto Selector) Mode

















- Flash mode ([35](#))
- Self-timer ([37](#))
- Exposure compensation ([40](#))
- Image mode ([66](#))

Scene Mode (Shooting Suited to Scenes)

When a scene is selected, camera settings are automatically optimized for the selected scene.

Enter shooting mode →  (shooting mode) button →  (second icon from the top*) →  →  → select a scene →  button

* The icon of the last scene selected is displayed.

 Portrait (default setting)	 Dusk/dawn ^{1, 2, 3}
 Landscape ^{1, 2}	 Night landscape ^{1, 2, 3} (📖21)
 Sports ² (📖21)	 Close-up (📖21)
 Night portrait ³	 Food (📖22)
 Party/indoor ² (📖21)	 Fireworks show ^{1, 3} (📖22)
 Beach ²	 Backlighting ² (📖22)
 Snow ²	 Panorama assist (📖24)
 Sunset ^{2, 3}	 Pet portrait (📖23)

¹ The camera focuses at infinity.

² The camera focuses on the area in the center of the frame.

³ Use of a tripod is recommended, because the shutter speed is slow. Set **Photo VR** (📖93) to **Off** in the setup menu when using a tripod to stabilize the camera during shooting.

Displaying a Description of Each Scene Mode (Help Display)

Select a scene and move the zoom control (📖1) toward **T** (👤) to view a description of that scene. To return to the previous screen, move the zoom control toward **T** (👤) again.

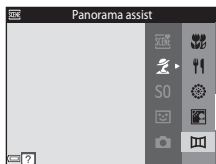

Tips and Notes





Sports

- While the shutter-release button is held all the way down, the camera shoots up to about 6 images continuously at a rate of about 1.1 fps (when image mode is set to **20M**).
- The frame rate for continuous shooting may vary depending on the current image mode setting, the memory card used, or shooting conditions.
- Focus, exposure, and hue are fixed at the values determined with the first image in each series.



Party/indoor

- To avoid the effects of camera shake, hold the camera steady. Set **Photo VR** (📖93) to **Off** in the setup menu when using a tripod to stabilize the camera during shooting.









Night landscape

- On the screen displayed when  **Night landscape** is selected, select  **Hand-held** or  **Tripod**.
-  **Hand-held** (default setting): Select this option to produce shots with reduced blurring and noise even when the camera is hand-held.
-  **Tripod**: Select this option when using a tripod or other means to stabilize the camera when shooting.
 - Vibration reduction is disabled even when **Photo VR** (📖93) in the setup menu is set to **On**.

Close-up

- Macro mode (📖39) is enabled and the camera automatically zooms to the closest position at which it can focus.
- You can move the focus area. Press the  button, use the multi selector  to move the focus area, and press the  button to apply the setting.

Food

- Macro mode () is enabled and the camera automatically zooms to the closest position at which it can focus.
- You can adjust hue by using the multi selector  . The hue setting is saved in the camera's memory even after the camera is turned off.
- You can move the focus area. Press the  button, use the multi selector     to move the focus area, and press the  button to apply the setting.







Fireworks show

- The shutter speed is fixed at four seconds.
- The zoom is restricted to four fixed positions.



Backlighting

- The flash always fires.

Pet portrait

- When you point the camera at a dog or cat, the camera detects the pet's face and focuses on it. By default, the camera detects a dog or cat face and automatically releases the shutter (pet portrait auto release).
- On the screen displayed when  **Pet portrait** is selected, select  **Single** or  **Continuous**.
 -  **Single**: The camera captures one image when a dog or cat face is detected.
 -  **Continuous**: The camera captures three images continuously when a dog or cat face is detected.

Pet Portrait Auto Release

- Press the multi selector  to change the **Pet portrait auto release** setting.
 - : The camera detects a dog or cat face and automatically releases the shutter.
 - **OFF**: The camera does not release the shutter automatically, even if a dog or cat face is detected. Press the shutter-release button. The camera also detects human faces when **OFF** is selected.
- **Pet portrait auto release** is set to **OFF** after five bursts have been taken.
- Shooting is also possible by pressing the shutter-release button, regardless of the **Pet portrait auto release** setting. When  **Continuous** is selected, you can take pictures continuously while holding down the shutter-release button all the way.

Focus Area

- When the camera detects a face, the face is displayed inside a yellow border. When the camera acquires focus on a face displayed inside a double border (focus area), the double border changes to green. If no faces are detected, the camera focuses on the subject in the center of the frame.
- Under some shooting conditions, the pet face may not be detected and other subjects may be displayed inside a border.

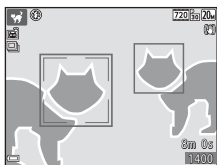

Shooting with Panorama Assist

The use of a tripod makes it easier to frame a picture. When using a tripod to stabilize the camera during shooting, set **Photo VR** (📖93) to **Off** in the setup menu.

Enter shooting mode → 📷 (shooting mode) button → 📷 (second icon from the top*) → ▶▶▶ ▲▼ → 📷 (Panorama assist) → OK button

* The icon of the last scene selected is displayed.

- 1 Use the multi selector ◀▶ to select the direction in which images are joined, and press the OK button.

- If necessary, apply flash mode (📖35), self-timer (📖37), macro mode (📖39) and exposure compensation (📖40) settings in this step.
- Press the OK button to reselect the direction.



- 2 Frame the first portion of the panorama scene and take the first picture.

- The camera focuses on the subject in the center of the frame.
- About one third of the image is displayed as translucent.



- 3 Take the next picture.

- Match the outline of the next image so that one third of the frame overlaps the previous image, and press the shutter-release button.



4 Press the **OK** button when shooting is complete.

- The camera returns to step 1.



✓ Notes About Panorama Assist

- Up to three images can be taken and combined in a panorama series. Shooting automatically ends after the third image is taken.
- A panorama image may not be saved if the translucent portion of an image is not properly aligned with the subject when taking the next image.
- The range of the image seen in the saved image is narrower than that seen in the monitor at the time of shooting.
- If shooting ends after only the first image is taken, the camera cannot scroll the playback of the image (📖26).
- Shooting for the panorama series is terminated if the auto off function (📖95) initiates standby mode during shooting. Setting the time allowed to elapse before the auto off function is enabled to a longer setting is recommended.
- Images cannot be deleted while shooting in panorama assist mode. When shooting a new image, return to step 1 and start over again.

📌 AE/AF-L Indicator

In panorama assist scene mode, exposure, white balance, and focus for all images in a panorama are fixed at the values for the first image in each series. When the first image is taken, **AE/AF-L** is displayed to indicate that exposure, white balance, and focus are locked.



Playback with Panorama Assist

Switch to playback mode (📖14), display an image captured using panorama assist in full-frame playback mode, and then press the **OK** button to scroll the image in the direction that was used when shooting.

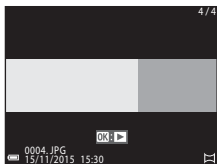

Playback controls are displayed in the monitor during playback.

Use the multi selector **◀▶** to select a control, and then press the **OK** button to perform the operations described below.

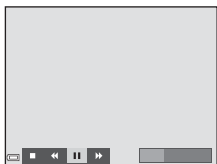

Function	Icon	Description
Rewind		Hold down the OK button to scroll backward quickly.
Advance		Hold down the OK button to scroll forward quickly.
Pause		Pause playback. The operations listed below can be performed while paused.
		Hold down the OK button to rewind.
		Hold down the OK button to scroll.
		Resume automatic scrolling.
End		Switch to full-frame playback mode.

✓ Notes About Panorama Assist Images





- The images cannot be edited on this camera.
- This camera may not be able to scroll the playback of, or zoom in on, panorama assist images captured with another make or model of digital camera.

✓ Notes About Printing Panorama Images







The entire image may not be able to be printed depending on the printer's settings. Additionally, printing may not be possible depending on the printer.

Special Effects Mode (Applying Effects When Shooting)

Effects can be applied to images during shooting.

Enter shooting mode →  (shooting mode) button → **S0** (third icon from the top*) →  →  →  → select an effect →  button

* The icon of the last effect selected is displayed.

Type	Description
S0 Soft (default setting)	Softens the image by adding a slight blur to the entire image.
SE Nostalgic sepia	Adds a sepia tone and reduces the contrast to simulate the qualities of an old photograph.
 High-contrast monochrome	Changes the image to black and white and gives it sharp contrast.
 Selective color	Creates a black and white image in which only the specified color remains.
POP Pop	Increases the color saturation of the entire image to create a bright look.
 Cross process	Gives the image a mysterious appearance based on a specific color.
 1 Toy camera effect 1	Gives the entire image a yellowish hue and darkens the image periphery.
 2 Toy camera effect 2	Decreases the color saturation of the entire image and darkens the image periphery.
 Mirror	Creates a bilaterally symmetric image whose right half is an inverted mirror image of the left half.

- The camera focuses on the area in the center of the frame.
- When **Selective color** or **Cross process** is selected, use the multi selector ▲▼ to select the desired color, and press the **OK** button to apply the color. To change the color selection, press the **OK** button again.



Smart Portrait Mode (Enhancing Human Faces When Shooting)

You can take a picture with the glamour retouch function to enhance human faces.

Enter shooting mode → 📷 (shooting mode) button → 😊 Smart portrait mode → Ⓞ button

1 Press the multi selector ▶.



2 Apply an effect.

- Use ◀▶ to select the desired effect.
- Use ▲▼ to select the amount of effect.
- You can simultaneously apply multiple effects.
👤 Skin softening, 🎨 Foundation makeup, 🌸 Soft, 🌟 Vividness, 📏 Brightness (Exp. +/-)
- Select ✕ Exit to hide the slider.
- After configuring the desired effects, press the Ⓞ button to apply them.

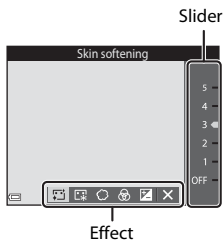

3 Frame the picture and press the shutter-release button.

✓ Notes About Smart Portrait Mode

The amount of effect may differ between the image on the shooting screen and the saved image.

Functions Available in Smart Portrait Mode

- Glamour retouch (📖29)
- Smile timer (📖30)
- Self-Collage (📖31)
- Flash mode (📖35)
- Self-timer (📖37)
- Smart portrait menu (📖76)

Using Smile Timer

Enter shooting mode → 📷 (shooting mode) button → 😊 Smart portrait mode → Ⓞ button

When you press the multi selector ◀ to select **Smile timer** and press the Ⓞ button, the camera automatically releases the shutter whenever a smiling face is detected.

- Set the glamour retouch function before selecting smile timer (📖29).
- When you press the shutter-release button to take a picture, smile timer is terminated.

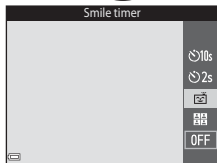

✓ Notes About Smile Timer

Under some shooting conditions, the camera may be unable to detect faces or smiles (📖43). The shutter-release button can also be used for shooting.

✎ When the Self-timer Lamp Flashes

When using smile timer, the self-timer lamp flashes when the camera detects a face and flashes quickly immediately after the shutter is released.

Using Self-Collage

The camera can capture a series of four or nine images at intervals and save them as a one-frame image (a collage image).



Enter shooting mode → (shooting mode) button → Smart portrait mode → button

1 Press the multi selector to select Self-Collage, and press the button.

- A confirmation dialog is displayed.
- When you press the **MENU** button and select **Self-Collage** before pressing , you can configure the settings for **Number of shots**, **Interval**, and **Shutter sound** (76).
- If you want to apply glamour retouch when shooting, set the effect before selecting self-collage (29).



2 Take a picture.

- When you press the shutter-release button, a countdown starts (about five seconds) and the shutter is automatically released.
- The camera automatically releases the shutter for the remaining pictures. A countdown starts about three seconds before shooting.
- The number of shots is indicated by  in the monitor. It is displayed in green during shooting and it changes to white after shooting.
- When the camera finishes taking the specified number of shots, the collage image is saved.
- Each captured image is saved as an individual image separate from the collage image.

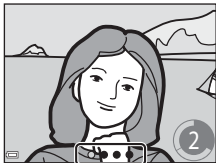



Notes About Self-Collage

- If you press the shutter-release button before the camera takes the specified number of shots, shooting is canceled and the collage image is not saved. The pictures that were taken before shooting was canceled are saved as individual images.
- This function may not be available to use in combination with other functions (48).





(Auto) Mode

Used for general shooting. Settings can be adjusted to suit the shooting conditions and the type of shot you want to capture.

Enter shooting mode →  (shooting mode) button →  (auto) mode →  button



- You can change how the camera selects the area of the frame to focus on by changing the **AF area mode** setting (72).
The default setting is **Target finding AF** (45).

Functions Available in (Auto) Mode

- Creative slider (33)
- Flash mode (35)
- Self-timer (37)
- Macro mode (39)
- Shooting menu (66)

Using the Creative Slider

You can adjust the brightness (exposure compensation), vividness, and hue when shooting.

Enter shooting mode →  (shooting mode) button →  (auto) mode →  button

- 1 Press the multi selector ►.



2 Use ◀▶ to select an item.

- **Hue**: Adjust the hue (reddish/bluish) of the entire image.
- **Vividness**: Adjust the vividness of the entire image.
- **Brightness (Exp. +/-)**: Adjust the brightness of the entire image.

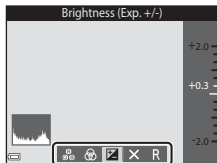

3 Use ▲▼ to adjust the level.

- You can preview the results on the monitor.
- To set another item, return to step 2.
- Select **Exit** to hide the slider.
- To cancel all settings, select **R Reset** and press the **OK** button. Return to step 2 and adjust the settings again.

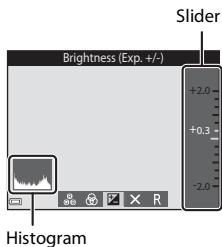

4 Press the **OK** button when setting is complete.

- The settings are applied and the camera returns to the shooting screen.

Creative Slider Settings

- This function may not be available to use in combination with other functions (48).
- The settings for brightness (exposure compensation), vividness and hue are saved in the camera's memory even after the camera is turned off.
- See "Using the Histogram" (40) for more information.

Flash Mode

You can select a flash mode to match the shooting conditions.

- 1 Press the multi selector ▲ (⚡).



- 2 Select the desired flash mode (📖36) and press the **OK** button.

- If the setting is not applied by pressing the **OK** button within a few seconds, the selection will be canceled.

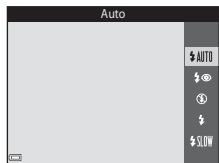

The Flash Lamp

- The status of the flash can be confirmed by pressing the shutter-release button halfway.
 - On: The flash fires when you press the shutter-release button all the way down.
 - Flashing: The flash is charging. The camera cannot shoot images.
 - Off: The flash does not fire when a picture is taken.
- If the battery level is low, the monitor turns off while the flash is charging.

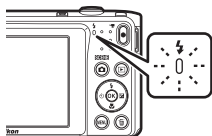

Available Flash Modes

AUTO Auto

The flash fires when necessary, such as in dim lighting.

- The flash mode icon on the shooting screen is displayed only immediately after the setting is made.

Auto with red-eye reduction

Reduce “red-eye” in portraits caused by the flash.

Off

The flash does not fire.

- We recommend using a tripod to stabilize the camera when shooting in dark surroundings.

Fill flash

The flash fires whenever a picture is taken. Use to “fill-in” (illuminate) shadows and backlit subjects.

SLOW Slow sync

Suited to evening and night portraits that include background scenery. The flash fires when necessary to illuminate the main subject; slow shutter speeds are used to capture background at night or under dim lighting.

The Flash Mode Setting

- The setting may not be available with some shooting modes (41).
- The setting applied in  (auto) mode is saved in the camera’s memory even after the camera is turned off.

Red-eye Reduction

If the camera detects red eye while saving an image, the affected area is processed to reduce red-eye before the image is saved.

Note the following when shooting:

- More time than usual is required to save images.
- Red-eye reduction may not produce the desired results in some situations.
- In rare cases, red-eye reduction may be applied unnecessarily to other areas of the image. In these cases, select another flash mode and take the picture again.

Self-timer

The camera is equipped with a self-timer that releases the shutter 10 seconds or 2 seconds after you press the shutter-release button.

Set **Photo VR** (📖93) to **Off** in the setup menu when using a tripod to stabilize the camera during shooting.

1 Press the multi selector ◀ (👁).



2 Select 🕒10s or 🕒2s, and press the OK button.

- 🕒10s (10 seconds): Use on important occasions, such as weddings.
- 🕒2s (2 seconds): Use to prevent camera shake.
- If the setting is not applied by pressing the OK button within a few seconds, the selection will be canceled.
- When the shooting mode is **Pet portrait** scene mode, 🐾 (pet portrait auto release) is displayed (📖23). The self-timer cannot be used.
- When the shooting mode is smart portrait mode, you can also use 😊 **Smile timer** (📖30) and 📷 **Self-Collage** (📖31) in addition to the self-timer.

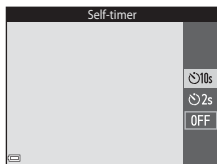

3 Frame the picture and press the shutter-release button halfway.

- Focus and exposure are set.

4 Press the shutter-release button the rest of the way down.

- Countdown starts. The self-timer lamp flashes and then glows steadily about one second before the shutter is released.
- When the shutter is released, the self-timer is set to **OFF**.
- To stop the countdown, press the shutter-release button again.

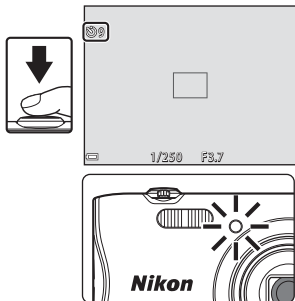

Macro Mode (Taking Close-up Pictures)

Use macro mode when taking close-up pictures.

- 1 Press the multi selector ▼ (🌿).



- 2 Select **ON** and press the **OK** button.

- If the setting is not applied by pressing the **OK** button within a few seconds, the selection will be canceled.



- 3 Move the zoom control to set the zoom ratio to a position where  and the zoom indicator are displayed in green.



- When the zoom ratio is set to a position where the zoom indicator is displayed in green, the camera can focus on subjects as close as approximately 9 cm (3.6 in.) from the lens.
When the zoom is at the position where  is displayed, the camera can focus on subjects as close as approximately 2 cm (0.8 in.) from the lens.

✓ Notes About Using the Flash

The flash may be unable to light the entire subject at distances of less than 50 cm (1 ft 8 in.).

📌 The Macro Mode Setting

- The setting may not be available with some shooting modes (📖41).
- If the setting is applied in  (auto) mode, it will remain saved in the camera's memory even after the camera is turned off.

Exposure Compensation (Adjusting Brightness)

You can adjust overall image brightness.

- 1 Press the multi selector ► (⊕).



- 2 Select a compensation value and press the OK button.

- To brighten the image, set a positive (+) value.
- To darken the image, set a negative (-) value.
- The compensation value is applied, even without pressing the OK button.
- When the shooting mode is smart portrait mode, the glamour retouch screen is displayed instead of the exposure compensation screen (📖29).
- When the shooting mode is 📷 (auto) mode, the creative slider is displayed instead of the exposure compensation screen (📖33).

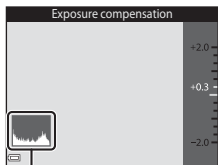

Histogram

Exposure Compensation Value

- The setting may not be available with some shooting modes (📖41).
- If the setting is applied in 📷 (auto) mode, it will remain saved in the camera's memory even after the camera is turned off.











































Using the Histogram







A histogram is a graph showing the distribution of tones in the image. Use as a guide when using exposure compensation and shooting without the flash.





- The horizontal axis corresponds to pixel brightness, with dark tones to the left and bright tones to the right. The vertical axis shows the number of pixels.
- Increasing the exposure compensation value shifts the tone distribution to the right, and decreasing it shifts the tone distribution to the left.

Default Settings (Flash, Self-timer, Etc.)

Default settings for each shooting mode are listed below.

	Flash ( 35)	Self-timer ( 37)	Macro ( 39)	Exposure compensation ( 40)
 (scene auto selector)	 AUTO ¹	Off	Off ²	0.0
 (scene)				
 (portrait)	 	Off	Off ³	0.0
 (landscape)	 ³	Off	Off ³	0.0
 (sports)	 ³	Off ³	Off ³	0.0
 (night portrait)	  ⁴	Off	Off ³	0.0
 (party/indoor)	  ⁵	Off	Off ³	0.0
 (beach)	 AUTO	Off	Off ³	0.0
 (snow)	 AUTO	Off	Off ³	0.0
 (sunset)	 ³	Off	Off ³	0.0
 (dusk/dawn)	 ³	Off	Off ³	0.0
 (night landscape)	 ³	Off	Off ³	0.0
 (close-up)		Off	On ³	0.0
 (food)	 ³	Off	On ³	0.0
 (fireworks show)	 ³	Off ³	Off ³	0.0 ³
 (backlighting)	 ³	Off	Off ³	0.0
 (panorama assist)		Off	Off	0.0
 (pet portrait)	 ³	 ⁶	Off	0.0

	Flash (35)	Self-timer (37)	Macro (39)	Exposure compensation (40)
 (special effects)		Off	Off	0.0
 (smart portrait)		Off ⁷	Off ³	– ⁸
 (auto)		Off	Off	– ⁹







- ¹ The camera automatically selects the flash mode appropriate for the scene it has selected.  (off) can be selected manually.
- ² Cannot be changed. The camera enters macro mode when  is selected.
- ³ Cannot be changed.
- ⁴ Cannot be changed. The flash mode setting is fixed at fill flash with red-eye reduction.
- ⁵ Slow sync with red-eye reduction flash mode may be used.
- ⁶ Self-timer cannot be used. Pet portrait auto release can be turned on or off ([23](#)).
- ⁷  **Smile timer** ([30](#)) and  **Self-Collage** ([31](#)) can be used in addition to self-timer.
- ⁸ Glamour retouch is displayed ([29](#)).
- ⁹ Creative slider is displayed ([33](#)).

Focusing

The focus area varies depending on the shooting mode.

Using Face Detection

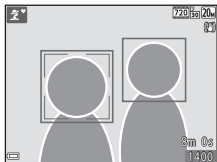

In the following shooting modes, the camera uses face detection to automatically focus on human faces.

-   **Portrait**,   **Night portrait**, or  **Backlighting** in  (scene auto selector) mode (19)
- **Portrait** or **Night portrait** scene mode (20)
- Smart portrait mode (29)
- When **AF area mode** (72) in  (auto) mode (33) is set to **Face priority**.



If the camera detects more than one face, a double border is displayed around the face that the camera focuses on, and single borders are displayed around the other faces.

If the shutter button is pressed halfway when no faces are detected:

- In  (scene auto selector) mode, the focus area changes depending on the scene.
- In **Portrait** and **Night portrait** scene modes or in smart portrait mode, the camera focuses in the center of the frame.
- In  (auto) mode, the camera selects the focus area containing the subject closest to the camera.

Notes About Face Detection

- The camera's ability to detect faces depends on a variety of factors, including the direction in which the faces are looking.
- The camera cannot detect faces in the following situations:
 - When faces are partially hidden by sunglasses or otherwise obstructed
 - When faces take up too much or too little of the frame

Using Skin Softening

When the shutter is released while using one of the shooting modes listed below, the camera detects human faces and processes the image to soften facial skin tones (up to three faces).

- Smart portrait mode (📖29)
 - The amount of **Skin softening** effect can be adjusted.
- **SCENE** (scene auto selector) mode (📖19)
- **Portrait** or **Night portrait** scene mode (📖20)

Editing functions such as **Skin softening** can be applied to saved images by using **Glamour retouch** (📖56) even after shooting.

✔ Notes About Skin Softening

- It may take more time than usual to save images after shooting.
- Under some shooting conditions, the desired skin softening results may not be achieved, and skin softening may be applied to areas of the image where there are no faces.

Using Target Finding AF

When **AF area mode** (📖72) in 📷 (auto) mode is set to **Target finding AF**, the camera focuses in the manner described below when you press the shutter-release button halfway.

- The camera detects the main subject and focuses on it. When the subject is in focus, the focus area is displayed in green. If a human face is detected, the camera automatically sets focus priority on it.

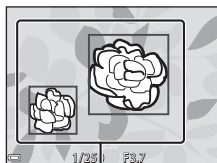

Focus areas

- If no main subject is detected, the camera automatically selects one or more of the nine focus areas containing the subject closest to the camera. When the subject is in focus, the focus areas that are in focus are displayed in green.

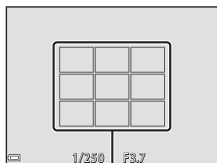

Focus areas

✓ Notes About Target Finding AF

- Depending on shooting conditions, the subject that the camera determines to be the main subject may vary.
- The main subject may not be detected when using certain **White balance** settings.
- The camera may not detect the main subject appropriately in the following situations:
 - When the subject is very dark or bright
 - When the main subject lacks clearly defined colors
 - When the shot is framed so that the main subject is at the edge of the monitor
 - When the main subject is composed of a repeating pattern

Subjects Not Suitable for Autofocus

The camera may not focus as expected in the following situations. In rare cases, the subject may not be in focus despite the fact that the focus area or the focus indicator is displayed in green:

- Subject is very dark
- Objects of sharply differing brightness are included in the scene (e.g. the sun behind the subject makes that subject appear very dark)
- No contrast between the subject and surroundings (e.g. a portrait subject wearing a white shirt is standing in front of a white wall)
- Several objects are at different distances from the camera (e.g. the subject is inside a cage)
- Subjects with repeating patterns (window blinds, buildings with multiple rows of similarly shaped windows, etc.)
- Subject is moving rapidly

In the situations noted above, try pressing the shutter-release button halfway to refocus several times, or focus on another subject positioned at the same distance from the camera as the actual desired subject, and use focus lock (📖47).

Focus Lock

Focus lock shooting is recommended when the camera does not activate the focus area that contains the desired subject.

1 Set **AF area mode** to **Center** in  (auto) mode (72).

2 Position the subject in the center of the frame and press the shutter-release button halfway.

- The camera focuses on the subject and the focus area is displayed in green.
- Exposure is also locked.

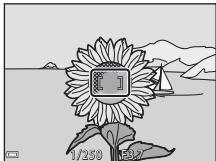

3 Without lifting your finger, recompose the picture.

- Make sure to maintain the same distance between the camera and the subject.

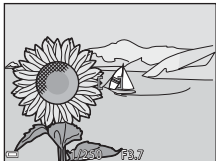

4 Press the shutter-release button the rest of the way down to take the picture.



Functions That Cannot Be Used Simultaneously When Shooting

Some functions cannot be used with other menu options.

Restricted function	Option	Description
Flash mode	Continuous (📖70)	When Continuous is selected, the flash cannot be used.
	Blink proof (📖77)	When Blink proof is set to On , the flash cannot be used.
Self-timer	AF area mode (📖72)	When Subject tracking is selected, the self-timer cannot be used.
Macro mode	AF area mode (📖72)	When Subject tracking is selected, macro mode cannot be used.
Image mode	ISO sensitivity (📖71)	When 3200 is selected, the image mode setting of only 4M 2272×1704 , 2M 1600×1200 , or VGA 640×480 can be selected. If any image mode setting other than above is selected, the image mode setting is automatically changed to 4M 2272×1704 when ISO sensitivity is set to 3200 .
White balance	Hue (Using the creative Slider) (📖33)	When Hue is adjusted using the creative slider, White balance setting is not available in the shooting menu.
AF area mode	Digital zoom (📖94)	When digital zoom is in effect, the camera focuses in the center of the frame regardless of the AF area mode setting.
Blink proof	Self-Collage (📖31)	When Self-Collage is set, Blink proof is disabled.

Restricted function	Option	Description
Digital zoom	AF area mode (📖72)	When Subject tracking is selected, digital zoom cannot be used.
Shutter sound	Continuous (📖70)	When Continuous is selected, the shutter sound is disabled.

✔ Notes About Digital Zoom

- Depending on the shooting mode or the current settings, digital zoom may not be available (📖94).
- When digital zoom is in effect, the camera focuses in the center of the frame.

Playback Features

Playback Zoom

Moving the zoom control toward **T** (Q playback zoom) in full-frame playback mode (📖14) zooms in on the image.

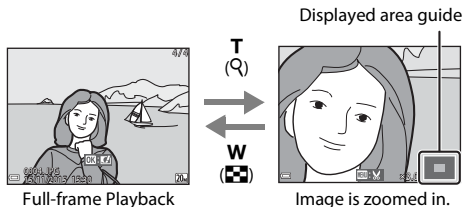

- You can change the magnification rate by moving the zoom control toward **W** (📐) or **T** (Q).
- To view a different area of the image, press the multi selector ▲▼◀▶.
- When a zoomed image is displayed, press the **OK** button to return to full-frame playback mode.

Cropping Images

When a zoomed image is displayed, you can press the **MENU** button to crop the image to include only the visible portion and save it as a separate file (📖59).

Thumbnail Playback/Calendar Display

Moving the zoom control toward **W** (🗄️ thumbnail playback) in full-frame playback mode (📖14) displays images as thumbnails.







- You can change the number of thumbnails displayed by moving the zoom control toward **W** (🗄️) or **T** (🔍).
- While using thumbnail playback mode, press the multi selector ▲▼◀▶ to select an image and then press the **OK** button to display that image in full-frame playback mode.
- While using calendar display mode, press ▲▼◀▶ to select a date and then press the **OK** button to display the images captured on that day.



✓ Notes About Calendar Display





Images captured when the camera's date is not set are treated as images captured on January 1, 2015.

List by Date Mode

Press the  button (playback mode) →  button →  List by date →  button

Use the multi selector ▲▼ to select a date and then press the  button to play back the images captured on the selected date.

- Functions in the playback menu () can be used for the images in the selected shooting date (except **Copy**).
- The following operations are available while the shooting date selection screen is displayed.
 - **MENU** button: The functions listed below are available.
 - Slide show
 - Protect*
 - * The same settings can be applied to all images captured on the selected date.
 -  button: Deletes all images captured on the selected date.

List by date		
	20/11/2015	[3]
	15/11/2015	[2]
	10/11/2015	[1]
	05/11/2015	[10]

Notes About List by Date Mode

- Up to the most recent 29 dates can be selected. If images exist for more than 29 dates, all images saved earlier than the most recent 29 dates will be combined under **Others**.
- The 9,000 most recent images can be displayed.
- Images captured when the camera's date is not set are treated as images captured on January 1, 2015.

Editing Images (Still Images)

Before Editing Images

You can easily edit images on this camera. Edited copies are saved as separate files.

Edited copies are saved with the same shooting date and time as the original.

Restrictions on Image Editing

- An image can be edited up to 10 times.
- You may not be able to edit images of a certain size or with certain editing functions.

Quick Effects: Changing Hue or Mood

Process images with a variety of effects.

Painting, Photo illustration, Soft portrait, Portrait (color + B&W), Fisheye, Cross screen, or Miniature effect can be selected.

- 1 Display the image to which you want to apply an effect in full-frame playback mode and press the  button.



2 Use the multi selector ▲▼◀▶ to select the desired effect and press the **OK** button.

- Move the zoom control (📄1) toward **T** (🔍) to switch to full-frame playback or **W** (🖼️) to switch to thumbnail playback.
- To exit without saving the edited image, press the **MENU** button.

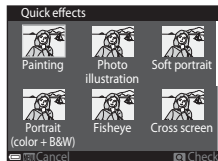

3 Select **Yes** and press the **OK** button.

- An edited copy is created.

Quick Retouch: Enhancing Contrast and Saturation



Press the **▶** button (playback mode) → select an image → **MENU** button
→ Quick retouch → **OK** button

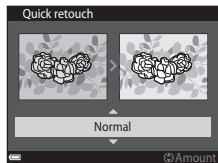

Use the multi selector ▲▼ to select the amount of effect applied and press the **OK** button.

- The edited version is displayed on the right.
- To exit without saving the copy, press **◀**.



D-Lighting: Enhancing Brightness and Contrast



Press the  button (playback mode) → select an image → MENU button → D-Lighting →  button

Use the multi selector   to select **OK** and press the  button.

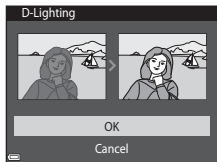
- The edited version is displayed on the right.
- To exit without saving the copy, select **Cancel** and press the  button.



Red-eye Correction: Correcting Red-eye When Shooting with the Flash

Press the  button (playback mode) → select an image → MENU button → Red-eye correction →  button

Preview the result and press the  button.

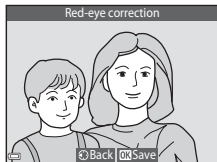

- To exit without saving the copy, press the multi selector .





Notes About Red-eye Correction

- Red-eye correction can only be applied to images when red-eye is detected.
- Red-eye correction can be applied to pets (dogs or cats) even if their eyes are not red.
- Red-eye correction may not produce the desired results in some images.
- In rare cases, red-eye correction may be applied unnecessarily to other areas of the image.



Glamour Retouch: Enhancing Human Faces

Press the  button (playback mode) → select an image → MENU button → Glamour retouch →  button

1 Use the multi selector  to select the face that you want to retouch and press the  button.

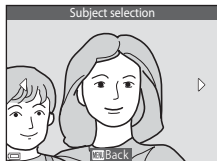











- When only one face is detected, proceed to step 2.



2 Use  to select the effect, use  to select the effect level, and press the  button.

- You can simultaneously apply multiple effects.

Adjust or check the settings for all effects before pressing the  button.

 (Small face),  (Skin softening),  (Foundation makeup),  (Glare reduction),  (Hide eye bags),  (Big eyes),  (Whiten eyes),  (Eye shadow),  (Mascara),  (Whiten teeth),  (Lipstick),  (Redden cheeks)

- Press the MENU button to return to the screen for selecting a person.

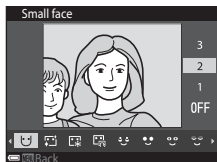

3 Preview the result and press the  button.

- To change the settings, press  to return to step 2.
- To exit without saving the edited image, press the MENU button.

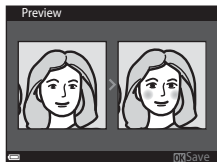

4 Select **Yes** and press the **OK** button.

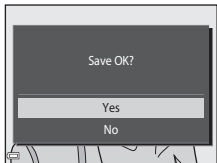

- An edited copy is created.





✓ Notes About Glamour Retouch

- Only one face at a time can be edited. To retouch another face in the same image, select the edited copy of the image and make additional changes.
- Depending on the direction in which faces are looking, or the brightness of faces, the camera may be unable to accurately detect faces, or the glamour retouch function may not perform as expected.
- If no faces are detected, a warning is displayed and the screen returns to the playback menu.
- The glamour retouch function is available only for images captured at an ISO sensitivity of 1600 or lower, and the image size of 640 × 480 or larger.

Small Picture: Reducing the Size of an Image

Press the  button (playback mode) → select an image → MENU button → Small picture →  button

1 Use the multi selector   to select the desired copy size and press the  button.

- Images captured at an image mode setting of  **5120×2880** are saved at a size of 640 × 360, and images captured at an image mode setting of  **3864×3864** are saved at 480 × 480. Press the  button to proceed to step 2.

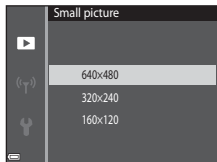

2 Select **Yes** and press the  button.

- An edited copy is created (compression ratio of approximately 1:8).

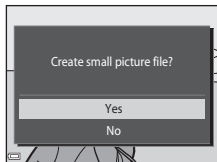

Crop: Creating a Cropped Copy

1 Move the zoom control to enlarge the image (📖50).

2 Adjust the image so that only the portion that you want to keep is displayed, and then press the **MENU** (menu) button.

- Move the zoom control toward **T** (📖) or **W** (📖) to adjust the magnification rate. Set a magnification rate at which **MENU**:✂️ is displayed.
- Use the multi selector ▲▼◀▶ to scroll to the portion of the image that you want to display.

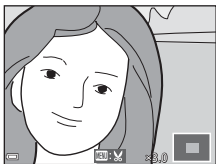

3 Check that the desired cropping area is displayed, and then press the **OK** button.

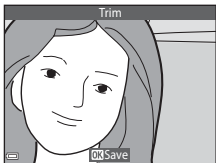

4 Select **Yes** and press the **OK** button.

- An edited copy is created.



Image Size

- The aspect ratio (horizontal and vertical ratio) of a cropped image is the same as that of the original image.
- An image that is cropped to a size of 320 × 240 or smaller is displayed at a small size on the playback screen.

Recording and Playing Back Movies

1 Display the shooting screen.

- Check the remaining amount of movie recording time.

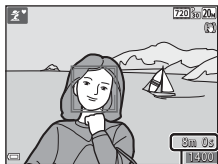

Remaining movie recording time

2 Press the (movie-record) button to start movie recording.

- The camera focuses in the center of the frame.

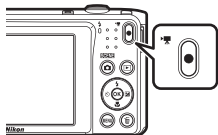

3 Press the (movie-record) button again to end recording.

4 Select a movie in full-frame playback mode and press the button to play it back.

- An image with a movie options icon is a movie.

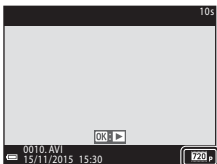

Movie options

Area Captured in Movies

- The area that is captured in a movie varies depending on the **Movie options** settings in the movie menu.
- If **Photo info** in **Monitor settings** (📖90) in the setup menu is set to **Movie frame+auto info**, you can confirm the area that will be captured in a movie before you start recording.

Maximum Movie Recording Time

Individual movie files cannot exceed 2 GB in size or 29 minutes in length, even when there is sufficient free space on the memory card for longer recording.

- The remaining recording time for a single movie is displayed on the shooting screen.
- The actual remaining recording time may vary depending on the movie content, subject movement, or type of memory card.
- Memory cards with an SD Speed Class rating of 6 or faster are recommended when recording movies (📖137). Movie recording may stop unexpectedly when memory cards with a lower Speed Class rating are used.

Notes About Camera Temperature

- The camera may become hot when shooting movies for an extended period of time or when the camera is used in a hot area.
- If the inside of the camera becomes extremely hot when recording movies, the camera will automatically stop recording.

The amount of time remaining until the camera stops recording (🔊10s) is displayed.

After the camera stops recording, it turns itself off.

Leave the camera off until the inside of the camera has cooled.

Notes About Movie Recording

✓ Notes About Saving Images or Movies

The indicator showing the number of exposures remaining or the indicator showing the remaining recording time flashes while images or movies are being saved. **Do not open the battery-chamber/memory card slot cover or remove the battery or memory card** while an indicator is flashing. Doing this could result in loss of data, or in damage to the camera or the memory card.

✓ Notes About Recorded Movies

- There may be some degradation in image quality when digital zoom is used.
- The sounds of zoom control operation, zoom, autofocus lens drive movement, movie vibration reduction, and aperture operation when brightness changes may be recorded.
- Smear (📖115) visible in the monitor with movie recording will be recorded with movies. Avoiding bright objects such as the sun, reflections of the sun, and electric lights when recording movies is recommended.
- Depending on the distance to the subject or the amount of zoom applied, colored stripes may appear on subjects with repeating patterns (fabrics, lattice windows, etc.) during movie recording and playback. This occurs when the pattern in the subject and the layout of the image sensor interfere with each other; it is not a malfunction.

✓ Notes About Vibration Reduction During Movie Recording

- When **Movie VR** (📖85) in the movie menu is set to **On (hybrid)**, the angle of view (i.e., the area visible in the frame) becomes narrower during movie recording.
- When using a tripod to stabilize the camera during shooting, set **Movie VR** to **Off** to prevent potential errors caused by this function.

✓ Notes About Autofocus for Movie Recording

Autofocus may not perform as expected (📖46). Should this occur, try the following:

1. Set **Autofocus mode** in the movie menu to **Single AF** (default setting) before starting movie recording.
2. Frame another subject (positioned at the same distance from the camera as the intended subject) in the center of the frame, press the **●** (📷 movie-record) button to start recording, and modify the composition.

Operations During Movie Playback

To adjust the volume, move the zoom control while a movie is playing (📖1).

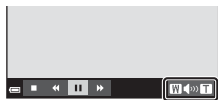

Volume indicator

Playback controls are displayed in the monitor. The operations described below can be performed by using the multi selector ◀▶ to select a control and then pressing the Ⓚ button.



When paused

Function	Icon	Description	
Rewind	◀	Hold down the Ⓚ button to rewind the movie.	
Advance	▶	Hold down the Ⓚ button to advance the movie.	
Pause	⏸	Pause playback. The operations listed below can be performed while paused.	
		◀⏮	Rewind the movie one frame. Hold down the Ⓚ button for continuous rewinding.
		⏭▶	Advance the movie one frame. Hold down the Ⓚ button for continuous advancing.
End	■	Return to full-frame playback mode.	

Using Menus

You can set the menus listed below by pressing the **MENU** (menu) button.

- **📷 Shooting menu**

Available by pressing the **MENU** button when the shooting screen is displayed.

Allows you to change image size and quality, continuous shooting settings, etc.

- **▶ Playback menu**

Available by pressing the **MENU** button when viewing images in full-frame playback mode or thumbnail playback mode.

Allows you to edit images, play slide shows, etc.

- **🎬 Movie menu**

Available by pressing the **MENU** button when the shooting screen is displayed.

Allows you to change movie recording settings.

- **📶 Wi-Fi options menu**

Allows you to configure Wi-Fi settings for connecting the camera and a smart device.

- **🔧 Setup menu**

Allows you to adjust basic camera functions such as date and time, display language, etc.

1 Press the **MENU** (menu) button.

- The menu is displayed.



2 Press the multi selector ◀.

- The current menu icon is displayed in yellow.

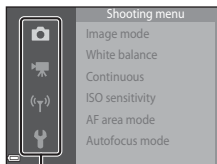

Menu icons

3 Select a menu icon and press the **OK** button.

- The menu options become selectable.

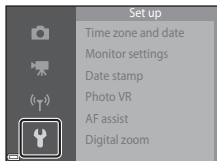

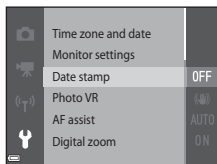

4 Select a menu option and press the **OK** button.

- Certain menu options cannot be set depending on the current shooting mode or the state of the camera.



5 Select a setting and press the **OK** button.

- The setting you selected is applied.
- When you are finished using the menu, press the **MENU** button.
- When a menu is displayed, you can switch to shooting mode by pressing the shutter-release button,  button, or  button.

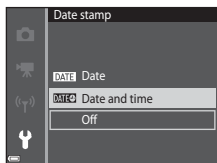

The Shooting Menu (for (Auto) Mode)









Image Mode (Image Size and Quality)

Enter shooting mode* → MENU button → Image mode →  button

* This setting can also be changed in shooting modes other than auto. The changed setting is also applied to other shooting modes.

Select the combination of image size and compression ratio to be used when saving images.

The higher the image mode setting, the larger the size at which it can be printed, and the lower the compression ratio, the higher the quality of the images, but the number of images that can be saved is reduced.

Option*	Compression ratio	Aspect ratio (horizontal to vertical)
 5152×3864★	Approx. 1:4	4:3
 5152×3864 (default setting)	Approx. 1:8	4:3
 3648×2736	Approx. 1:8	4:3
 2272×1704	Approx. 1:8	4:3
 1600×1200	Approx. 1:8	4:3
 640×480	Approx. 1:8	4:3
 5120×2880	Approx. 1:8	16:9
 3864×3864	Approx. 1:8	1:1

* The numerical values indicate the number of pixels that are captured.
Example:  **5152×3864** = approx. 20 megapixels, 5152 × 3864 pixels

Notes About Printing Images at 1:1 Aspect Ratio

Change the printer setting to "Border" when printing images at a 1:1 aspect ratio. Some printers may not be able to print images at a 1:1 aspect ratio.





Notes About Image Mode

This function may not be available to use in combination with other functions (48).





Number of Images That Can Be Saved

- The approximate number of images that can be saved can be checked in the monitor when shooting (10).
- Note that due to JPEG compression, the number of images that can be saved may vary greatly depending on the image content, even when using memory cards with the same capacity and the same image mode setting. In addition, the number of images that can be saved may vary depending on the make of the memory card.
- If the number of exposures remaining is 10,000 or more, the number of exposures remaining display shows "9999".

White Balance (Adjusting Hue)

Enter shooting mode →  (shooting mode) button →  (auto) mode
→  button → MENU button → White balance →  button

Adjust white balance to suit the light source or weather conditions in order to make the colors in images match what you see with your eyes.

Option	Description
AUTO Auto (default setting)	White balance is automatically adjusted.
PRE Preset manual	Use when the desired result is not achieved with Auto , Incandescent , etc. (📖69).
 Daylight	Use under direct sunlight.
 Incandescent	Use under incandescent lighting.
 Fluorescent	Use under fluorescent lighting.
 Cloudy	Use under overcast skies.
 Flash	Use with the flash.

Notes About White Balance

- Set the flash to  (off) when white balance is set to any setting other than **Auto** and **Flash** (📖35).
- This function may not be available to use in combination with other functions (📖48).

Using Preset Manual

Use the procedure below to measure the white balance value under the lighting used during shooting.

1 Place a white or gray reference object under the lighting that will be used during shooting.

2 Use the multi selector ▲▼ to select **Preset manual** in the **White balance** menu, and press the **OK** button.

- The camera zooms in to the position for measuring white balance.

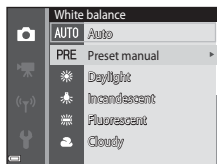

3 Select **Measure**.

- To apply the last measured value, select **Cancel** and press the **OK** button.

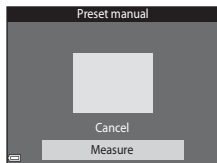

4 Frame the white or gray reference object in the measuring window, and press the **OK** button to measure the value.

- The shutter is released and measurement is complete (no image is saved).

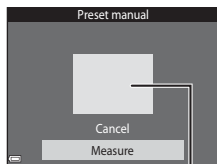







Measuring window

✓ Notes About Preset Manual

A value for flash lighting cannot be measured with **Preset manual**. When shooting using the flash, set **White balance** to **Auto** or **Flash**.

Continuous Shooting





Enter shooting mode →  (shooting mode) button →  (auto) mode
→  button → MENU button → Continuous →  button

Option	Description
 Single (default setting)	One image is captured each time the shutter-release button is pressed.
 Continuous	While the shutter-release button is held all the way down, images are captured continuously. <ul style="list-style-type: none">• The frame rate for continuous shooting is about 1.1 fps and the maximum number of continuous shots is about 6 (when image mode is set to  5152×3864).

Notes About Continuous Shooting

- Focus, exposure, and white balance are fixed at the values determined with the first image in each series.
- It may take some time to save the images after shooting.
- This function may not be available to use in combination with other functions ( 48).

ISO Sensitivity

Enter shooting mode →  (shooting mode) button →  (auto) mode
→  button → MENU button → ISO sensitivity →  button

A higher ISO sensitivity allows darker subjects to be captured. Additionally, even with subjects of similar brightness, pictures can be taken at faster shutter speeds, and blurring caused by camera shake and subject movement can be reduced.

- When a higher ISO sensitivity is set, images may contain noise.

Option	Description
AUTO Auto (default setting)	Sensitivity is automatically selected from the range of ISO 80 to 1600.
ISO AUTO Fixed range auto	Select the range in which the camera automatically adjusts ISO sensitivity, from ISO 80-400 or ISO 80-800 .
80, 100, 200, 400, 800, 1600, 3200	Sensitivity is locked at the specified value.

Notes About ISO Sensitivity

This function may not be available to use in combination with other functions (48).

Notes About ISO 3200

When **ISO sensitivity** is set to **3200**, the available **Image mode** settings are limited to **4M** **2272×1704**, **2M** **1600×1200**, and **VGA** **640×480**.  is displayed next to the ISO sensitivity indicator in the monitor.



ISO Sensitivity Display on the Shooting Screen



- When **Auto** is selected, **ISO** is displayed when the ISO sensitivity increases.
- When **Fixed range auto** is selected, the maximum value for ISO sensitivity is displayed.

AF Area Mode

Enter shooting mode → (shooting mode) button → (auto) mode
 → button → MENU button → AF area mode → button

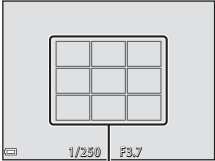
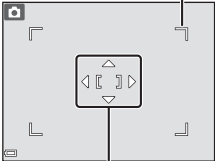
Set how the camera selects the focus area for autofocus.

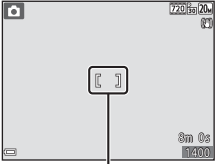

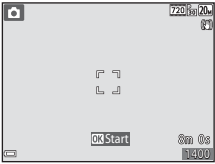
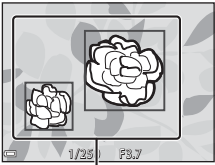



Option	Description
Face priority	<p>When the camera detects a human face, it focuses on that face. See "Using Face Detection" (📖43) for more information.</p>  <p>Focus area</p> <p>When framing a composition with no human subjects or detected faces, the camera automatically selects one or more of the nine focus areas containing the subject closest to the camera when the shutter-release button is pressed halfway.</p>  <p>Focus areas</p>
Manual	<p>Use the multi selector to move the focus area to where you want to focus.</p> <ul style="list-style-type: none"> To use the multi selector to configure the flash mode or other settings, press the button. To return to moving the focus area, press the button again. <p>Scope of movable focus area</p>  <p>Focus area</p>

Option	Description
<p>[▪] Center</p>	<p>The camera focuses on the subject in the center of the frame.</p>  <p>The image shows a camera's viewfinder with a central focus area bracket. A line points from the text 'Focus area' below to the bracket. The viewfinder also displays technical information: '720'1/20' in the top right, '8m 0s' and '1/400' in the bottom right, and a camera icon in the top left.</p> <p style="text-align: center;">Focus area</p>
<p> Subject tracking</p>	<p>Use this function to take pictures of moving subjects. Register the subject on which the camera focuses. The focus area automatically moves to track the subject. See “Using Subject Tracking” (📖74) for more information.</p>  <p>The image shows a camera's viewfinder with four registration points (L-shaped brackets) forming a square in the center. A line points from the text 'Focus area' below to these points. The viewfinder also displays technical information: '720'1/20' in the top right, '8m 0s' and '1/400' in the bottom right, and 'OK Start' in the bottom center. A camera icon is in the top left.</p> <p style="text-align: center;">Focus area</p>
<p>[▪▪] Target finding AF (default setting)</p>	<p>When the camera detects the main subject, it focuses on that subject. See “Using Target Finding AF” (📖45) for more information.</p>  <p>The image shows a camera's viewfinder with two focus areas. A larger square focus area is centered on a flower, and a smaller square focus area is positioned to its left. A line points from the text 'Focus areas' below to the larger focus area. The viewfinder also displays technical information: '1/25' and 'F3.7' at the bottom. A camera icon is in the top left.</p> <p style="text-align: center;">Focus areas</p>



Notes About AF Area Mode

- When digital zoom is in effect, the camera focuses in the center of the frame regardless of the **AF area mode** setting.
- This function may not be available to use in combination with other functions (📖48).

Using Subject Tracking

Enter shooting mode →  (shooting mode) button →  (auto) mode
→  button → MENU button → AF area mode →  button →
 Subject tracking →  button → MENU button

1 Register a subject.

- Align the subject that you want to track with the border in the center of the monitor and press the  button.
- When the subject is registered, a yellow border (focus area) is displayed around it and the camera begins tracking the subject.
- If the subject cannot be registered, the border is displayed in red. Change the composition and try registering the subject again.
- To cancel subject registration, press the  button.
- If the camera can no longer track the registered subject, the focus area disappears. Register the subject again.

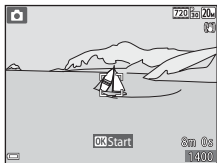

2 Press the shutter-release button fully to take the picture.



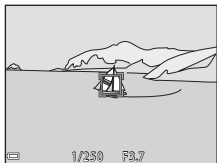

- If the shutter-release button is pressed while the focus area is not displayed, the camera focuses on the subject in the center of the frame.



Notes About Subject Tracking

- If you perform operations such as zooming while the camera is tracking the subject, the registration is canceled.
- Subject tracking may not be possible in certain shooting conditions.

Autofocus Mode

Enter shooting mode →  (shooting mode) button →  (auto) mode
→  button → MENU button → Autofocus mode →  button

Set how the camera focuses when shooting still images.

Option	Description
AF-S Single AF (default setting)	The camera focuses only when the shutter-release button is pressed halfway.
AF-F Full-time AF	The camera continues focusing even when the shutter-release button is not pressed halfway. The sound of lens drive movement is heard while the camera focuses.



Autofocus Mode for Movie Recording

Autofocus mode for movie recording can be set with **Autofocus mode** (84) in the movie menu.

The Smart Portrait Menu





- See “Image Mode (Image Size and Quality)” (📖66) for information about **Image mode**.

Self-Collage

Enter shooting mode → 📷 (shooting mode) button → 😊 Smart portrait mode → Ⓞ button → MENU button → Self-Collage → Ⓞ button

Option	Description
Number of shots	Set the number of shots that the camera automatically captures (number of captured images for an aggregated image). <ul style="list-style-type: none">• 4 (default setting) or 9 can be selected.
Interval	Set the interval time between each shot. <ul style="list-style-type: none">• Short, Medium (default setting), or Long can be selected.
Shutter sound	Set whether to activate the shutter sound when shooting with the self-collage function. <ul style="list-style-type: none">• Standard, SLR, Magic (default setting), or Off can be selected.• The shutter sound is not produced when Shutter sound is set to Off in Sound settings in the setup menu.

Blink Proof

Enter shooting mode →  (shooting mode) button →  Smart portrait mode →  button → MENU button → Blink proof →  button

Option	Description
 On	<p>The camera automatically releases the shutter twice with every shot and saves one image in which the subject's eyes are open.</p> <ul style="list-style-type: none">• If the camera saved an image in which the subject's eyes may have been closed, the dialog shown on the right is displayed for a few seconds.• The flash cannot be used.
Off (default setting)	Turns the blink proof off.





Notes About Blink Proof

This function may not be available to use in combination with other functions ( 48).

The Playback Menu

- See “Editing Images (Still Images)” (📖53) for information about image editing functions.

Mark for Wi-Fi Upload



Press the  button (playback mode) → MENU button → Mark for Wi-Fi upload →  button

Select images in the camera that you want to transfer to a smart device in advance before transferring them.

On the image selection screen (📖82), select or deselect images for the **Mark for Wi-Fi upload** function.



Note that when you select **Reset all** (📖99) in the setup menu or **Restore default settings** (📖86) in the Wi-Fi options menu, the Mark for Wi-Fi upload settings that you made are canceled.

Slide Show

Press the  button (playback mode) → MENU button → Slide show →  button



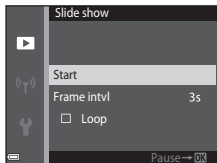

Play back images one by one in an automated “slide show.” When movie files are played back in the slide show, only the first frame of each movie is displayed.

1 Use the multi selector to select **Start** and press the button.

- The slide show begins.
- To change the interval between images, select **Frame intvl**, press the  button, and specify the desired interval time before selecting **Start**.
- To repeat the slide show automatically, select **Loop** and press the  button before selecting **Start**.
- The maximum playback time is up to about 30 minutes even if **Loop** is enabled.





2 End or restart the slide show.



- The screen shown on the right is displayed after the slide show ends or is paused. To exit the show, select  and then press the  button. To resume the slide show, select  and then press the  button.



Operations During Playback

- Use the multi selector  to display the previous/next image. Press and hold to rewind/fast forward.
- Press the  button to pause or end the slide show.

Protect



Press the  button (playback mode) → MENU button → Protect →  button

The camera protects selected images from accidental deletion.



Select images to protect or cancel protection from the image selection screen (82).

Note that formatting the memory card or the camera's internal memory permanently deletes all data including protected files (96).

Rotate Image

Press the  button (playback mode) → MENU button → Rotate image →  button

Specify the orientation in which saved images are displayed during playback. Still images can be rotated 90 degrees clockwise or 90 degrees counterclockwise.

Select an image from the image selection screen (82). When the Rotate image screen is displayed, press the multi selector  to rotate the image 90 degrees.



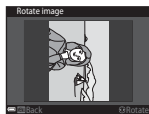

Rotate 90 degrees
counterclockwise



Rotate 90 degrees
clockwise



Press the  button to finalize display orientation, and save orientation information with the image.

Copy (Copy Between the Memory Card and Internal Memory)

Press the  button (playback mode) → MENU button → Copy →  button

Images can be copied between a memory card and the internal memory.

- When a memory card that contains no images is inserted and the camera is switched to playback mode, **Memory contains no images.** is displayed. In that case, press the MENU button to select **Copy**.

- 1 Use the multi selector   to select a destination option to which images are copied and press the  button.

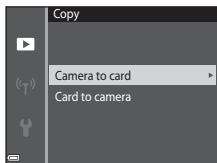

- 2 Select a copy option and press the  button.

- When you choose **Selected images**, use the image selection screen to specify images (82).

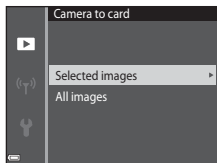

Notes About Copying Images

- Only files in formats that this camera can record can be copied.
- Operation is not guaranteed with images captured with another make of camera or that have been modified on a computer.

The Image Selection Screen

When an image selection screen such as the one shown on the right is displayed while operating the camera, follow the procedures described below to select the images.

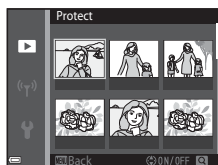

1 Use the multi selector ◀▶ to select an image.

- Move the zoom control (📖1) toward **T** (🔍) to switch to full-frame playback or **W** (📐) to switch to thumbnail playback.
- Only one image can be selected for **Rotate image**. Proceed to step 3.

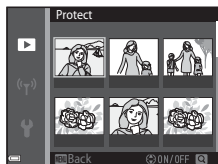

2 Use ▲▼ to select or deselect (or to specify the number of copies).

- When an image is selected, an icon is displayed below the image. Repeat steps 1 and 2 to select additional images.





3 Press the (OK) button to apply image selection.

- When a confirmation dialog is displayed, follow the on-screen instructions to operate.







The Movie Menu





Movie Options

Enter shooting mode → MENU button →  menu icon → Movie options
→  button



Select the desired movie option to record. The movie options that can be selected vary depending on the **Video mode** setting (197).

- Memory cards with an SD Speed Class rating of 6 or faster are recommended for recording movies (137).

Option (Image size/Frame rate)	Image size	Aspect ratio (horizontal to vertical)
 720/30p  720/25p (default setting*)	1280 × 720	16:9
 480/30p  480/25p	640 × 480	4:3
 240/30p  240/25p	320 × 240	4:3

* When recording in the internal memory, the default setting is  **480/30p** or  **480/25p**, and  **720/30p** or  **720/25p** cannot be selected.



Autofocus Mode

Enter shooting mode → MENU button →  menu icon → Autofocus mode →  button



Set how the camera focuses in movie mode.

Option	Description
AF-S Single AF (default setting)	Focus is locked when movie recording starts. Select this option when the distance between the camera and subject will remain fairly consistent during movie recording.
AF-F Full-time AF	The camera focuses continuously during movie recording. Select this option when the distance between the camera and subject will change significantly during recording. The sound of the camera focusing may be heard in the recorded movie. Use of Single AF is recommended to prevent the sound of the camera focusing from interfering with recording.

Movie VR

Enter shooting mode → MENU button →  menu icon → Movie VR →  button



Select the vibration reduction setting used when recording movies.
Select **Off** when using a tripod to stabilize the camera during shooting.

Option	Description
 * On (hybrid) (default setting)	Performs optical compensation for camera shake using lens shift VR and simultaneously performs electronic VR using image processing. The angle of view (i.e., the area visible in the frame) becomes narrower.
 On	Performs compensation for camera shake using lens shift VR.
Off	Compensation is not performed.

Notes About Movie VR

- The effects of camera shake may not be completely eliminated in some situations.

Wind Noise Reduction

Enter shooting mode → MENU button →  menu icon → Wind noise reduction →  button

Option	Description
 On	Reduces the sound that is produced when wind passes over the microphone during movie recording. Other sounds may become difficult to hear during playback.
Off (default setting)	Wind noise reduction is disabled.

The Wi-Fi Options Menu

Press the **MENU** button → «**T**» menu icon → **OK** button

Configure the Wi-Fi (wireless LAN) settings to connect the camera and a smart device.

Option	Description
Connect to smart device	Select when wirelessly connecting the camera and a smart device. See "Using the Wi-Fi (Wireless LAN) Function" (📖100) for more information.
Upload from camera	Select when wirelessly connecting the camera and a smart device. See "Using the Wi-Fi (Wireless LAN) Function" (📖100) for more information. <ul style="list-style-type: none">• Before establishing the wireless connection, select the images to upload on the image selection screen (📖82). After images are selected, the SSID and password of the camera are displayed on the screen.
Disable Wi-Fi	Select to terminate the wireless connection between the camera and a smart device. See "Using the Wi-Fi (Wireless LAN) Function" (📖100) for more information.
Options	SSID: Change the SSID. The SSID configured here is displayed on the smart device. Set a 1- to 24-character alphanumeric SSID.
	Auth./encryp.: Select whether or not to encrypt the communications between the camera and the connected smart device. Communications are not encrypted when Open (default setting) is selected.
	Password: Set the password. Set an 8- to 16-character alphanumeric password.
	Channel: Select the channel used for wireless connections.
Current settings	Display the current settings.
Restore default settings	Restore the Wi-Fi settings to their default values. The wireless connection is terminated if this option is performed while Wi-Fi is connected.

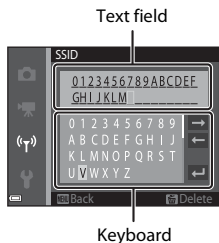

Operating the Text Input Keyboard

- Use the multi selector ▲▼◀▶ to select alphanumeric characters. Press the **OK** button to enter the selected character in the text field and move the cursor to the next space.
- To move the cursor in the text field, select ← or → on the keyboard, and press the **OK** button.
- To delete one character, press the **🗑** button.
- To apply the setting, select ↩ on the keyboard and press the **OK** button.







The Setup Menu

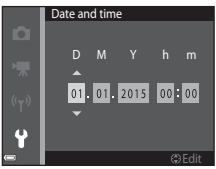

Time Zone and Date

Press the MENU button →  menu icon → Time zone and date →  button



Set the camera clock.

Option	Description
Date and time	<ul style="list-style-type: none">• Select a field: Press the multi selector .• Edit the date and time: Press .• Apply the setting: Select the minute setting and press the  button. 
Date format	Select Year/Month/Day , Month/Day/Year , or Day/Month/Year .
Time zone	Set time zone and daylight saving time. <ul style="list-style-type: none">• When Travel destination () is set after having set the home time zone () the time difference between the travel destination and the home time zone is automatically calculated, and the date and time are saved for the selected region.

Setting the Time Zone

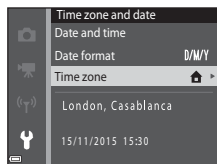
- 1 Use the multi selector   to select **Time zone** and press the  button.



2 Select  **Home time zone** or  **Travel destination** and press the  button.



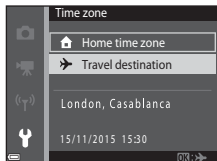

- The date and time displayed in the monitor changes depending on whether the home time zone or travel destination is selected.

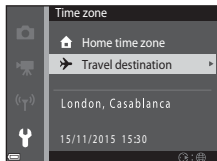

3 Press .



4 Use   to select the time zone.

- Press  to enable daylight saving time function, and  is displayed. Press  to disable the daylight saving time function.
- Press the  button to apply the time zone.
- If the correct time is not displayed for the home or travel destination time zone setting, set the appropriate time in **Date and time**.

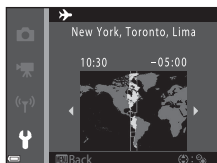







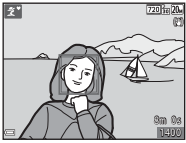

Monitor Settings

Press the MENU button →  menu icon → Monitor settings →  button

Option	Description
Photo info	Set whether or not to display information in the monitor.
Image review	Set whether or not to display the captured image immediately after shooting. <ul style="list-style-type: none">• Default setting: On
Brightness	Adjust the brightness. <ul style="list-style-type: none">• Default setting: 3

Photo Info

	Shooting mode	Playback mode
Show info		
Auto info (default setting)	The same information as shown in Show info is displayed, and it is hidden as shown in Hide info if no operations are performed for a few seconds. The information is displayed again when an operation is performed.	
Hide info		

	Shooting mode	Playback mode
Framing grid+auto info	 <p>In addition to the information shown in Auto info, a framing grid is displayed to help frame pictures. The framing grid is not displayed while recording movies.</p>	 <p>Same as Auto info.</p>
Movie frame+auto info	 <p>In addition to the information shown in Auto info, a frame is displayed before movie recording begins that represents the area that will be captured when recording movies. The movie frame is not displayed while recording movies.</p>	 <p>Same as Auto info.</p>

Date Stamp

Press the **MENU** button → **Y** menu icon → Date stamp → **OK** button

The shooting date and time can be stamped on images when shooting. The information can be printed even when using a printer that does not support the date imprinting function.



Option	Description
DATE Date	Date is stamped on images.
DATE Date and time	Date and time are stamped on images.
Off (default setting)	Date and time are not stamped on images.



Notes About Date Stamp

- Stamped dates form a permanent part of image data and cannot be deleted. The date and time cannot be stamped on images after they have been captured.
- The date and time cannot be stamped in the following situations:
 - When using **Panorama assist** scene mode
 - When shooting movies
- The stamped date and time may be difficult to read when using a small image size.

Printing a Shooting Date on Images Without a Date Stamp

You can transfer images to a computer and use the ViewNX 2 software (111) to imprint the shooting date on the images when they are printed.

Photo VR

Press the **MENU** button →  menu icon → Photo VR →  button



Select the vibration reduction setting used when shooting still images. Select **Off** when using a tripod to stabilize the camera during shooting.

Option	Description
 On (default setting)	Compensation for camera shake is performed using lens shift VR.
Off	Compensation is not performed.

Notes About Photo VR



- After turning on the camera or after switching from playback mode to shooting mode, wait for the shooting mode screen to be displayed completely before taking pictures.
- Images in the camera monitor may be displayed blurry immediately after shooting.
- The effects of camera shake may not be completely eliminated in some situations.

AF Assist

Press the MENU button →  menu icon → AF assist →  button

Option	Description
AUTO Auto (default setting)	The AF-assist illuminator automatically lights up when you press the shutter-release button under dim lighting. The illuminator has a range of about 2.0 m (6 ft 6 in.) at the maximum wide-angle position and about 1.5 m (4 ft 11 in.) at the maximum telephoto position. <ul style="list-style-type: none">Note that for some scene modes or focus areas, the AF-assist illuminator may not light.
Off	The AF-assist illuminator does not light.

Digital Zoom

Press the MENU button →  menu icon → Digital zoom →  button

Option	Description
On (default setting)	Digital zoom is enabled.
Off	Digital zoom is disabled.

Notes About Digital Zoom



- Digital zoom cannot be used in the following shooting modes:
 - Portrait**, **Night portrait**, or **Pet portrait** scene mode
 - Smart portrait mode
- Digital zoom cannot be used in other shooting modes when using certain settings (49).

Sound Settings

Press the MENU button →  menu icon → Sound settings →  button

Option	Description
Button sound	<p>When On (default setting) is selected, the camera produces one beep when operations are performed, two beeps when focus is acquired on the subject, and three beeps when an error occurs. The start-up sound is also produced.</p> <ul style="list-style-type: none">• Sounds are disabled when using Pet portrait scene mode.
Shutter sound	<p>When On (default setting) is selected, the shutter sound is produced when the shutter is released.</p> <ul style="list-style-type: none">• The shutter sound is not produced when using continuous shooting mode, when recording movies, or when using Pet portrait scene mode.

Auto Off

Press the MENU button →  menu icon → Auto off →  button

Set the amount of time that elapses before the camera enters standby mode (12).

You can select **30 s**, **1 min** (default setting), **5 min**, or **30 min**.

Setting the Auto Off Function

The time that passes before the camera enters standby mode is fixed in the following situations:

- When a menu is displayed: 3 minutes (when auto off is set to **30 s** or **1 min**)
- When shooting using **Pet portrait auto release**: 5 minutes (when auto off is set to **30 s** or **1 min**)
- When shooting using **Smile timer**: 5 minutes (when auto off is set to **30 s** or **1 min**)
- When the AC Adapter EH-62G is connected: 30 minutes
- When an audio video cable is connected: 30 minutes

Format Card/Format Memory

Press the **MENU** button → **Y** menu icon → Format card/Format memory → **OK** button

Use this option to format a memory card or the internal memory.

Formatting the memory cards or internal memory permanently deletes all data. Data that has been deleted cannot be recovered. Make sure to save important images to a computer before formatting.

Formatting a Memory Card

- Insert a memory card into the camera.
- Select **Format card** in the setup menu and then press the **OK** button.

Formatting the Internal Memory

- Remove the memory card from the camera.
- Select **Format memory** in the setup menu and then press the **OK** button.

To start formatting, select **Format** on the screen that is displayed and press the **OK** button.

- Do not turn the camera off or open the battery-chamber/memory card slot cover during formatting.
- This setting cannot be selected while Wi-Fi is connected.

Language

Press the **MENU** button → **Y** menu icon → Language → **OK** button

Select a language for display of camera menus and messages.

Video Mode

Press the **MENU** button → **Y** menu icon → Video mode → **OK** button



Adjust settings necessary for connection to a TV.

Select from **NTSC** and **PAL**.

Both **NTSC** and **PAL** are standards for analog color television broadcasting.

- The available frame rates in **Movie options** (📖83) vary depending on the video mode setting.

Charge by Computer

Press the MENU button →  menu icon → Charge by computer →  button

Option	Description
AUTO Auto (default setting)	When the camera is connected to a computer that is running ( 104), the battery inserted into the camera is automatically charged using power supplied by the computer.
Off	The battery inserted into the camera is not charged when the camera is connected to a computer.

Notes About Charging with a Computer

- When connected to a computer, the camera turns on and starts charging. If the camera is turned off, charging stops.
- About 3 hours are required to charge a fully exhausted battery. Charging time increases when images are transferred while the battery is charging.
- The camera turns off automatically if there is no communication with the computer for 30 minutes after the battery has finished charging.

When the Charge Lamp Quickly Flashes Green

Charging cannot be performed, possibly due to one of the reasons described below.

- The ambient temperature is not suited to charging. Charge the battery indoors with an ambient temperature of 5°C to 35°C (41°F to 95°F).
- The USB cable is not connected correctly, or the battery is faulty. Make sure the USB cable is connected correctly or replace the battery if necessary.
- The computer is in sleep mode and is not supplying power. Wake up the computer.
- The battery cannot be charged because the computer cannot supply power to the camera due to the computer's settings or its specifications.

Reset All

Press the **MENU** button → **Y** menu icon → **Reset all** → **OK** button

When **Reset** is selected, the camera's settings are restored to their default values.

- Some settings, such as **Time zone and date** or **Language**, are not reset.
- This setting cannot be selected while Wi-Fi is connected.

Resetting File Numbering

To reset file numbering to "0001", delete all images saved on the memory card or in the internal memory (📖15) before selecting **Reset all**.

Conformity Marking

Press the **MENU** button → **Y** menu icon → **Conformity marking** → **OK** button

View some of the conformity markings that the camera complies with.

Firmware Version

Press the **MENU** button → **Y** menu icon → **Firmware version** → **OK** button

View the current camera firmware version.

- This setting cannot be selected while Wi-Fi is connected.

Using the Wi-Fi (Wireless LAN) Function

You can perform the following functions if you install the dedicated software “Wireless Mobile Utility” on your smart device that runs on Android OS or iOS, and connect it to the camera.

Take Photos

You can capture still images using the two methods described below.

- Release the shutter on the camera and save the captured images to a smart device.
- Use a smart device to remotely release the camera shutter and save images to the smart device.

View Photos

Images that are saved in the camera’s memory card can be transferred and viewed on your smart device. You can also preselect the images in the camera that you want to transfer to your smart device.

Notes

Security settings such as the password are not configured at the time of purchase. It is the user’s responsibility to configure the appropriate security settings in **Options** in the Wi-Fi options menu (📖64) if necessary.

Installing the Software on the Smart Device

1 Use your smart device to connect to the Google Play Store, App Store or other online apps marketplace and search for “Wireless Mobile Utility.”

- Check the user’s manual provided with your smart device for further details.

2 Check the description and other information and install the software.

User’s Manual for Wireless Mobile Utility

Download the user’s manual from the website below.

- Android OS: <http://nikonimglib.com/ManDL/WMAU/>
- iOS: <http://nikonimglib.com/ManDL/WMAU-ios/>

To establish a connection with the camera, press the (📶) (Wi-Fi) button on the camera, turn on the Wi-Fi function of the smart device, and then start the “Wireless Mobile Utility” on the smart device while “Negotiating... Please wait.” is displayed on the camera.

Connecting the Smart Device to the Camera

- 1 Press the (Wi-Fi) button on the camera.



- The screen shown on the right is displayed.
- If no connection confirmation is received from the smart device within three minutes, **No access.** is displayed and the camera returns to the Wi-Fi options screen.
- You can also select **Connect to smart device** in the Wi-Fi options menu to display the screen shown on the right.



- 2 Set the Wi-Fi setting on the smart device to On.

- Check the user's manual provided with your smart device for further details.
- After the network names (SSIDs) that can be used for the smart device are displayed, select the SSID displayed on the camera.
- When **Auth./encrypt.** in the Wi-Fi options menu is set to **WPA2-PSK-AES**, the message for entering a password is displayed. Enter the password that is displayed on the camera.

- 3 While "Negotiating... Please wait." is displayed on the camera, start the "Wireless Mobile Utility" installed on the smart device.

- The screen for selecting "Take photos" or "View photos" is displayed.
- When the message "Cannot connect to camera." is displayed, return to step 1 and retry the procedure.
- "Installing the Software on the Smart Device" (100).

Touching an NFC-compatible Smart Device to the Camera for a Wi-Fi Connection

When you use an Android OS smart device that is compatible with near field communication (NFC) functions, you can establish a Wi-Fi connection and start the "Wireless Mobile Utility" by touching the NFC antenna of the smart device to the  (N-Mark) on the camera.

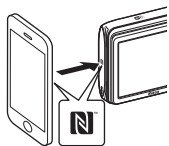

To Terminate the Wi-Fi Connection

Perform one of the operations described below.

- Turn off the camera.
- Select **Disable Wi-Fi** in the Wi-Fi options menu on the camera (except when the camera is operated by remote control).
- Set the Wi-Fi setting on the smart device to Off.

Notes About Wi-Fi Connection

- Wi-Fi connection operations are disabled in the following situations:
 - When using the camera's USB connection
 - While recording movies
 - While the camera is processing data such as saving images or recording movies
 - When the camera is connected to a smart device
- Select **Disable Wi-Fi** in areas where the use of radio waves is prohibited.
- When Wi-Fi is connected, **Auto off** is disabled.
- When Wi-Fi is connected, the battery drains faster than normal.
- If the battery level is low, the Wi-Fi connection is disconnected.

Security Settings

If no security settings (encryption and password) are configured for the camera's Wi-Fi function, unauthorized third parties may access the network and cause harm. We strongly recommend performing the required security settings before using the Wi-Fi function.

Use **Options** in the Wi-Fi options menu (86) to perform the security settings.

Preselecting Images in the Camera That You Want to Transfer to a Smart Device

You can preselect images in the camera that you want to transfer to a smart device. Movies cannot be preselected for transfer.

1 Select images to transfer.

You can preselect the images to transfer to a smart device in the following menus:

- **Mark for Wi-Fi upload** in the playback menu (📖78)
- **Upload from camera** in the Wi-Fi options menu (📖86)

When using **Upload from camera**, the SSID and password of the camera are displayed after images are selected.

2 Connect the camera and smart device (📖101).

When you tap “View Photos” in the “Wireless Mobile Utility”, the confirmation screen is displayed and the specified images are transferred to the smart device.

Preselecting Images to Transfer During Playback

While the camera is in playback mode, press the (📶) (Wi-Fi) button or use the NFC function to establish a Wi-Fi connection, and preselect the displayed images that you want to transfer.

- In full-frame playback mode, you can add one image at a time.
- In thumbnail playback mode, you can add one image that is selected by the cursor.
- In calendar display mode, you can add all images that were captured on the selected date.

This operation is not available when you use **Connect to smart device** in the Wi-Fi options menu to establish the Wi-Fi connection.

Connecting the Camera to a TV, Printer, or Computer

You can enhance your enjoyment of images and movies by connecting the camera to a TV, printer, or computer.

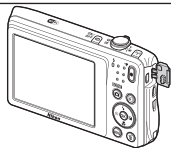
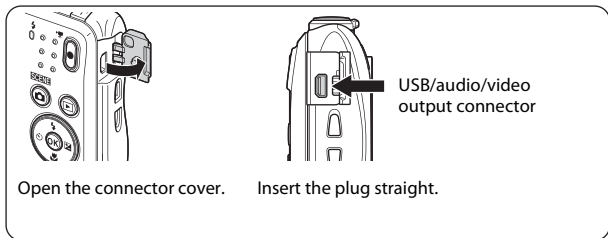

- Before connecting the camera to an external device, make sure the remaining battery level is sufficient and turn the camera off. Before disconnecting, make sure to turn the camera off.
- If the AC Adapter EH-62G (available separately) is used, this camera can be powered from an electrical outlet. Do not use any other make or model of AC adapter as it may cause the camera to heat up or malfunction.
- For information about the connection methods and subsequent operations, refer to the documentation included with the device in addition to this document.



Images and movies captured with the camera can be viewed on a TV.

Connection method: Connect the video and audio plugs of an optional audio video cable to the TV's input jacks.



If you connect the camera to a PictBridge-compatible printer, you can print images without using a computer.

Connection method: Connect the camera directly to the printer's USB port with the USB cable.



You can transfer images to a computer to perform simple retouching and manage image data.

Connection method: Connect the camera to the computer's USB port with the USB cable.

- Before connecting to a computer, install ViewNX 2 on the computer (📖111).
- If any USB devices that draw the power from the computer are connected, disconnect them from the computer before you connect the camera to it. Connecting the camera and other USB-powered devices to the same computer simultaneously may cause a camera malfunction or excessive power supply from the computer, which could damage the camera or memory card.

Connecting the Camera to a TV (Playback on a TV)

1 Turn off the camera and connect it to the TV.

- Connect the yellow plug to the video-in jack and the white plug to the audio-in jack on the TV.
- Make sure that the plugs are properly oriented. Do not insert or remove the plugs at an angle when connecting or disconnecting them.

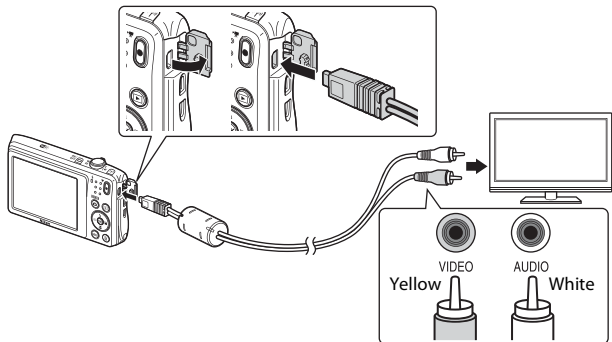

2 Set the TV's input to external video input.

- See the documentation provided with your TV for details.

3 Hold down the (playback) button to turn on the camera.

- Images are displayed on the TV.
- The camera monitor does not turn on.

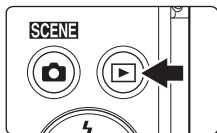

Connecting the Camera to a Printer (Direct Print)

Users of PictBridge-compatible printers can connect the camera directly to the printer and print images without using a computer.

Connecting the Camera to a Printer

- 1 Turn on the printer.
- 2 Turn off the camera and connect it to the printer using the USB cable.
 - Make sure that the plugs are properly oriented. Do not insert or remove the plugs at an angle when connecting or disconnecting them.

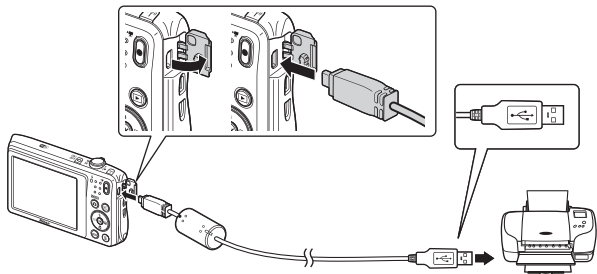

- 3 The camera is automatically turned on.
 - The **PictBridge** startup screen (①) is displayed in the camera monitor, followed by the **Print selection** screen (②).

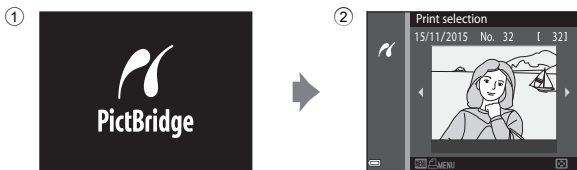

✓ If the PictBridge Startup Screen Is Not Displayed

When **Auto** is selected for **Charge by computer** (📖98), it may be impossible to print images with direct connection of the camera to some printers. If the PictBridge startup screen is not displayed after the camera is turned on, turn the camera off and disconnect the USB cable. Set **Charge by computer** to **Off** and reconnect the camera to the printer.

Printing Images One at a Time

1 Use the multi selector ◀▶ to select the desired image and press the **OK** button.

- Move the zoom control toward **W** (📐) to switch to thumbnail playback or **T** (🔍) to switch to full-frame playback.

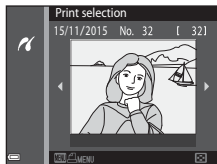

2 Use ▲▼ to select **Copies** and press the **OK** button.

- Use ▲▼ to set the desired number of copies (up to nine) and press the **OK** button.

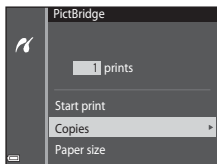

3 Select **Paper size** and press the **OK** button.

- Select the desired paper size and press the **OK** button.
- To print with the paper size setting configured on the printer, select **Default**.
- The paper size options available on the camera vary depending on the printer that you use.

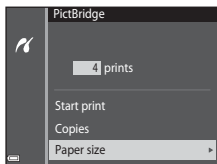

4 Select **Start print** and press the **OK** button.

- Printing starts.

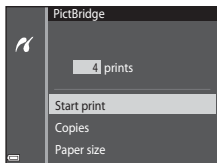

Printing Multiple Images

- 1 When the **Print selection** screen is displayed, press the **MENU** (menu) button.

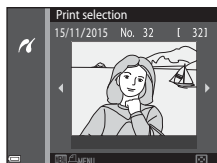

- 2 Use the multi selector ▲▼ to select **Paper size** and press the **OK** button.

- Select the desired paper size and press the **OK** button.
- To print with the paper size setting configured on the printer, select **Default**.
- The paper size options available on the camera vary depending on the printer that you use.
- To exit the print menu, press the **MENU** button.

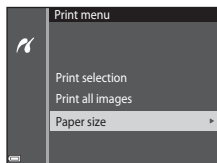

- 3 Select **Print selection** or **Print all images** and press the **OK** button.

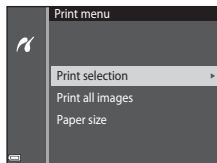

Print selection

Select images (up to 99) and the number of copies (up to 9) of each.

- Use the multi selector ◀▶ to select images, and use ▲▼ to specify the number of copies to be printed.
- Images selected for printing are indicated by  and the number of copies to be printed. To cancel the print selection, set the number of copies to 0.
- Move the zoom control toward **T** (🔍) to switch to full-frame playback or **W** (🖼️) to switch to thumbnail playback.
- Press the **OK** button when setting is complete. When the screen for confirming the number of print copies is displayed, select **Start print** and press the **OK** button to start printing.

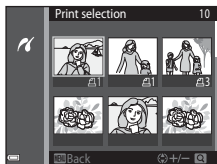

Print all images

One copy each of all images saved in the internal memory, or on the memory card, is printed.

- When the screen for confirming the number of print copies is displayed, select **Start print** and press the **OK** button to start printing.

Using ViewNX 2 (Transferring Images to a Computer)

Installing ViewNX 2

ViewNX 2 is free software that enables you to transfer images and movies to your computer so that you can view, edit, or share them. To install ViewNX 2, download the ViewNX 2 installer from the website below and follow the on-screen installation instructions.

<http://nikonimglib.com/nvnx/>

For system requirements and other information, see the Nikon website for your region.

Transferring Images to a Computer

1 Prepare a memory card that contains images.

You can use any of the methods below to transfer images from the memory card to a computer.

- **SD memory card slot/card reader:** Insert the memory card into the card slot of your computer or the card reader (commercially available) that is connected to the computer.
- **Direct USB connection:** Turn the camera off and ensure that the memory card is inserted in the camera. Connect the camera to the computer using the USB cable.

The camera automatically turns on.

To transfer images that are saved in the camera's internal memory, remove the memory card from the camera before connecting it to the computer.

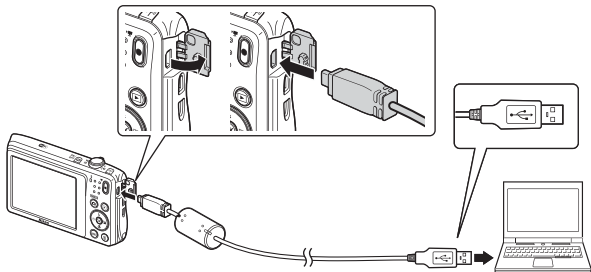

If a message is displayed prompting you to choose a program, select Nikon Transfer 2.

• When using Windows 7

If the dialog shown at right is displayed, follow the steps below to select Nikon Transfer 2.

- 1 Under **Import pictures and videos**, click **Change program**. A program selection dialog will be displayed; select **Import File using Nikon Transfer 2** and click **OK**.
- 2 Double-click **Import File**.



If the memory card contains a large number of images, it may take a while for Nikon Transfer 2 to start. Wait until Nikon Transfer 2 starts.

✓ Notes About Connecting the USB Cable

Operation is not guaranteed if the camera is connected to the computer via a USB hub.

2 After Nikon Transfer 2 starts, click **Start Transfer**.

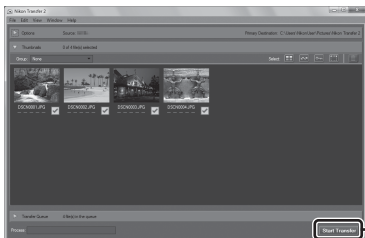

- Image transfer begins. When image transfer is complete, ViewNX 2 starts and the transferred images are displayed.
- Consult online help for more information on using ViewNX 2.

3 Terminate the connection.

- If you are using a card reader or card slot, choose the appropriate option in the computer operating system to eject the removable disk corresponding to the memory card and then remove the memory card from the card reader or card slot.
- If the camera is connected to the computer, turn the camera off and disconnect the USB cable.

Technical Notes

Caring for the Product	114
The Camera.....	114
The Battery.....	115
The Charging AC Adapter	116
Memory Cards.....	117
Cleaning and Storage	118
Cleaning.....	118
Storage	118
Error Messages	119
Troubleshooting	123
File Names.....	130
Optional Accessories.....	131
Specifications	132
Approved Memory Cards	137
Index.....	139

Caring for the Product

Observe the precautions described below in addition to the warnings in “For Your Safety” (📖vi–viii) when using or storing the device.

The Camera

Do Not Apply Strong Impact to the Camera

The product may malfunction if subjected to strong shock or vibration. In addition, do not touch or apply force to the lens or lens cover.

Keep Dry

The device will be damaged if immersed in water or subjected to high humidity.

Avoid Sudden Changes in Temperature

Sudden changes in temperature, such as when entering or leaving a heated building on a cold day, can cause condensation to form inside the device. To prevent condensation, place the device in a carrying case or a plastic bag before exposing it to sudden changes in temperature.

Keep Away from Strong Magnetic Fields

Do not use or store this device in the vicinity of equipment that generates strong electromagnetic radiation or magnetic fields. Doing so could result in loss of data or camera malfunction.

Do Not Point the Lens at Strong Light Sources for Extended Periods

Avoid pointing the lens at the sun or other strong light sources for extended periods when using or storing the camera. Intense light may cause the image sensor to deteriorate or produce a white blur effect in photographs.

Turn the Product Off Before Removing or Disconnecting the Power Source or Memory Card

Do not remove the battery while the product is on, or while images are being saved or deleted. Forcibly cutting power in these circumstances could result in loss of data or in damage to product memory or internal circuitry.

Notes About the Monitor

- Monitors and electronic viewfinders are constructed with extremely high precision; at least 99.99% of pixels are effective, with no more than 0.01% being missing or defective. Hence while these displays may contain pixels that are always lit (white, red, blue, or green) or always off (black), this is not a malfunction and has no effect on images recorded with the device.
- Images in the monitor may be difficult to see under bright lighting.
- Do not apply pressure to the monitor, as this could cause damage or malfunction. Should the monitor break, care should be taken to avoid injury caused by broken glass and to prevent the liquid crystal from the display touching the skin or entering the eyes or mouth.

Notes About Smear

White or colored streaks may be visible when bright subjects are framed in the monitor. This phenomenon, known as “smear,” occurs when extremely bright light strikes the image sensor; it is characteristic of image sensors and does not indicate a malfunction. Smear may also take the form of partial discoloration in the monitor during shooting. It does not appear in images saved with the camera except in the cases of movies. When recording movies, we recommend that you avoid bright subjects such as the sun, reflected sunlight, and electric lights.

The Battery

Precautions for Use

- Note that the battery may become hot after use.
- Do not use the battery at ambient temperatures below 0°C (32°F) or above 40°C (104°F) as this could cause damage or malfunction.
- If you notice any abnormalities such as excessive heat, smoke, or an unusual smell coming from the battery, immediately discontinue use and consult your retailer or Nikon-authorized service representative.
- After removing the battery from the camera or optional battery charger, put the battery in a plastic bag, etc. in order to insulate it.

Charging the Battery

Check the battery level before using the camera and replace or charge the battery if necessary.

- Charge the battery indoors with an ambient temperature of 5°C to 35°C (41°F to 95°F) before use.
- A high battery temperature may prevent the battery from charging properly or completely, and may reduce battery performance. Note that the battery may become hot after use; wait for the battery to cool before charging. When charging the battery inserted into this camera using the Charging AC Adapter or a computer, the battery is not charged at battery temperatures below 0°C (32°F) or above 45°C (113°F).
- Do not continue charging once the battery is fully charged as this will result in reduced battery performance.
- The battery temperature may increase during charging. However, this is not a malfunction.

Carrying Spare Batteries

Whenever possible, carry fully charged spare batteries when taking pictures on important occasions.

Using the Battery When Cold

On cold days, the capacity of batteries tends to decrease. If an exhausted battery is used at a low temperature, the camera may not turn on. Keep spare batteries in a warm place and exchange as necessary. Once warmed, a cold battery may recover some of its charge.

Battery Terminals

Dirt on the battery terminals may prevent the camera from functioning. Should the battery terminals become dirty, wipe them off with a clean, dry cloth before use.

Charging an Exhausted Battery

Turning the camera on or off while an exhausted battery is inserted in the camera may result in reduced battery life. Charge the exhausted battery before use.

Storing the Battery

- Always remove the battery from the camera or optional battery charger when it is not being used. Minute amounts of current are drawn from the battery while it is in the camera, even when not in use. This may result in excessive battery drain and complete loss of function.
- Recharge the battery at least once every six months and completely exhaust it before returning it to storage.
- Put the battery in a plastic bag, etc. in order to insulate it and store it in a cool place. The battery should be stored in a dry location with an ambient temperature of 15°C to 25°C (59°F to 77°F). Do not store the battery in hot or extremely cold locations.

Battery Life

A marked drop in the time a fully charged battery retains its charge, when used at room temperature, indicates that the battery needs to be replaced. Purchase a new battery.

Recycling Used Batteries

Replace the battery when it no longer holds a charge. Used batteries are a valuable resource. Please recycle used batteries in accordance with local regulations.

The Charging AC Adapter

- The Charging AC Adapter EH-70P/EH-70PCH/EH-72P/EH-72PCH is for use only with compatible devices. Do not use with another make or model of device.
- Do not, under any circumstances, use another make or model of AC adapter other than Charging AC Adapter EH-70P/EH-70PCH/EH-72P/EH-72PCH or USB-AC adapter. Failure to observe this precaution could result in overheating or in damage to the camera.
- The EH-70P/EH-70PCH/EH-72P/EH-72PCH is compatible with AC 100–240 V, 50/60 Hz electrical outlets. When using in other countries, use a plug adapter (commercially available) as necessary. For more information about plug adapters, consult your travel agency.

Memory Cards

Precautions for Use

- Use only Secure Digital memory cards. See “Approved Memory Cards” (📖137) for recommended memory cards.
- Be sure to follow the precautions described in the documentation included with the memory card.
- Do not put labels or stickers on memory cards.

Formatting

- Do not format the memory card using a computer.
- The first time you insert a memory card that has been used in another device into this camera, be sure to format it with this camera. We recommend formatting new memory cards with this camera before using them with this camera.
- **Note that formatting a memory card permanently deletes all images and other data on the memory card.** Be sure to make copies of any images you wish to keep before formatting the memory card.
- If the message **Card is not formatted. Format card?** is displayed when the camera is turned on, the memory card must be formatted. If there is data that you do not want to delete, select **No**. Copy the necessary data to a computer, etc. If you want to format the memory card, select **Yes**. The confirmation dialog will be displayed. To start formatting, press the **OK** button.
- Do not perform the following during formatting, while data is being written to or deleted from the memory card, or during data transfer to a computer. Failure to observe this precaution could result in the loss of data or in damage to the camera or memory card:
 - Open the battery-chamber/memory card slot cover to remove/insert the battery or memory card.
 - Turn off the camera.
 - Disconnect the AC adapter.

Cleaning and Storage

Cleaning

Do not use alcohol, thinner, or other volatile chemicals.

Lens	Avoid touching glass parts with your fingers. Remove dust or lint with a blower (typically a small device with a rubber bulb attached to one end that is pumped to produce a stream of air out the other end). To remove fingerprints or other stains that cannot be removed with a blower, wipe the lens with a soft cloth, using a spiral motion that starts at the center of the lens and working toward the edges. If this fails, clean the lens using a cloth lightly dampened with commercial lens cleaner.
Monitor	Remove dust or lint with a blower. To remove fingerprints and other stains, clean the monitor with a soft, dry cloth, being careful not to apply pressure.
Body	Use a blower to remove dust, dirt, or sand, then wipe gently with a soft, dry cloth. After using the camera at the beach or other sandy or dusty environment, wipe off any sand, dust, or salt with a dry cloth lightly dampened with fresh water and dry thoroughly. Note that foreign matter inside the camera could cause damage not covered by the warranty.

Storage



Remove the battery if the camera will not be used for an extended period. To prevent mold or mildew, take the camera out of storage at least once a month. Turn the camera on and release the shutter a few times before putting the camera away again. Do not store the camera in any of the following locations:

- Places that are poorly ventilated or subject to humidity of over 60%
- Exposed to temperatures above 50°C (122°F) or below -10°C (14°F)
- Next to equipment that produces strong electromagnetic fields, such as televisions or radios

For storing the battery, follow the precautions in “The Battery” (📖115) in “Caring for the Product” (📖114).









Error Messages

Refer to the table below if an error message is displayed.

Display	Cause/Solution	
Battery temperature is elevated. The camera will turn off.	The camera turns off automatically. Wait until the camera or battery temperature has cooled before resuming use.	–
The camera will turn off to prevent overheating.		
Memory card is write protected.	The write-protect switch is in the “lock” position. Slide the write-protect switch to the “write” position.	–
This card cannot be used.	An error occurred while accessing the memory card. <ul style="list-style-type: none"> • Use an approved memory card. • Check that the terminals are clean. • Confirm that the memory card is correctly inserted. 	6, 137
This card cannot be read.		
Card is not formatted. Format card?	The memory card has not been formatted for use in the camera. Formatting deletes all data saved on the memory card. If you need to keep copies of any images, make sure to select No and save the copies to a computer or other medium before formatting the memory card. Select Yes and press the  button to format the memory card.	117
Out of memory.	Delete images or insert a new memory card.	6, 15

Display	Cause/Solution	
Image cannot be saved.	An error occurred while saving the image. Insert a new memory card or format the memory card or internal memory.	96
	The camera has run out of file numbers. Insert a new memory card or format the memory card or internal memory.	96
	There is insufficient space to save the copy. Delete images from the destination.	15
Image cannot be modified.	Check that the images can be edited.	53, 128
Cannot record movie.	A time-out error occurred while saving the movie on the memory card. Select a memory card with a faster write speed.	62, 137
Memory contains no images.	There are no images in the internal memory or on the memory card.	6
	<ul style="list-style-type: none"> • Remove the memory card to play back images in the internal memory. • To copy the images saved in the camera's internal memory to the memory card, press the MENU button to select Copy in the playback menu. 	81
File contains no image data.	The file was not created or edited with this camera.	–
This file cannot be played back.	The file cannot be viewed on this camera. View the file using a computer or the device used to create or edit this file.	
All images are hidden.	There are no images available for a slide show, etc.	79
This image cannot be deleted.	The image is protected. Disable protection.	80

Display	Cause/Solution	
No access.	<p>The camera could not receive the signal from the smart device. Establish the wireless connection again.</p> <ul style="list-style-type: none"> • Press the (W) (Wi-Fi) button. • Touch an NFC-compatible smart device to the camera. • Select Connect to smart device in the Wi-Fi options menu. 	86, 101
Could not connect.	<p>The camera failed to establish the connection while receiving the signals from the smart device. Set a different channel in Channel under Options in the Wi-Fi options menu, and establish the wireless connection again.</p>	86, 101
Wi-Fi connection terminated.	<p>The Wi-Fi connection is disconnected in the following situations:</p> <ul style="list-style-type: none"> • When the reception is poor • When the battery level is low • When a cable is connected or disconnected, or a memory card is removed or inserted <p>Use a fully charged battery, disconnect the TV, computer, and printer from the camera, and establish the wireless connection again.</p>	86, 101
Lens error. Try again after turning the camera off and on.	<p>If the error persists, contact your retailer or Nikon-authorized service representative.</p>	123
Communications error	<p>An error occurred while communicating with the printer. Turn the camera off and reconnect the USB cable.</p>	107
System error	<p>An error occurred in the camera's internal circuitry. Turn the camera off, remove and reinsert the battery, and turn the camera on. If the error persists, contact your retailer or Nikon-authorized service representative.</p>	123

Display	Cause/Solution	
Printer error: check printer status.	After solving the problem, select Resume and press the  button to resume printing.*	–
Printer error: check paper.	Load the specified size of paper, select Resume , and press the  button to resume printing.*	–
Printer error: paper jam.	Remove the jammed paper, select Resume , and press the  button to resume printing.*	–
Printer error: out of paper.	Load the specified size of paper, select Resume , and press the  button to resume printing.*	–
Printer error: check ink.	There is a problem with the printer's ink. Check the ink, select Resume , and press the  button to resume printing.*	–
Printer error: out of ink.	Replace the ink cartridge, select Resume , and press the  button to resume printing.*	–
Printer error: file corrupt.	There is a problem with the image file to be printed. Select Cancel and press the  button to cancel printing.	–



* See the documentation provided with your printer for further guidance and information.

Troubleshooting

If the camera fails to function as expected, check the list of common problems below before consulting your retailer or Nikon-authorized service representative.



Power, Display, Settings Issues



Problem	Cause/Solution	
The camera is on but does not respond.	Wait for recording to end. If the problem persists, turn the camera off. If the camera does not turn off, remove and reinsert the battery or batteries or, if you are using an AC adapter, disconnect and reconnect the AC adapter. Note that although any data currently being recorded will be lost, data that have already been recorded will not be affected by removing or disconnecting the power source.	–
The camera cannot be turned on.	The battery is exhausted.	6, 7, 116
The camera turns off without warning.	<ul style="list-style-type: none">• The camera automatically turns off to save power (auto off function).• The camera and battery may not work properly at low temperatures.• The inside of the camera has become hot. Leave the camera off until the inside of the camera has cooled, and then try turning it on again.	12 115 –
The monitor is blank.	<ul style="list-style-type: none">• The camera is off.• The camera automatically turns off to save power (auto off function).• The flash lamp flashes while the flash is charging. Wait until charging is complete.• The camera is connected to a TV or computer.• The camera and smart device are connected using a Wi-Fi connection and the camera is being operated by remote control.	9 12 – – –
The camera becomes hot.	The camera may become hot when used for an extended period of time to shoot movies or when used in a hot environment; this is not a malfunction.	–







Problem	Cause/Solution	
The battery inserted in the camera cannot be charged.	<ul style="list-style-type: none"> • Confirm all connections. • When connected to a computer, the camera may not charge for any of the reasons described below. <ul style="list-style-type: none"> - Off is selected for Charge by computer in the setup menu. - Battery charging stops if the camera is turned off. - Battery charging is not possible if the camera's display language and date and time have not been set, or the date and time were reset after the camera's clock battery was exhausted. Use the Charging AC Adapter to charge the battery. - Battery charging may stop when the computer enters sleep mode. - Depending on the computer specifications, settings, and status, battery charging may not be possible. 	7 64, 98 – 9, 10 – –
The monitor is hard to read.	<ul style="list-style-type: none"> • Adjust the monitor brightness. • The monitor is dirty. Clean the monitor. 	90 118
 flashes on the screen. Date and time of recording are not correct.	<ul style="list-style-type: none"> • If the camera clock has not been set,  flashes on the shooting screen, and images and movies saved before the clock is set are dated "00/00/0000 00:00" and "01/01/2015 00:00" respectively. Set the correct time and date for Time zone and date in the setup menu. • The camera clock is not as accurate as ordinary watches or clocks. Periodically compare the time of the camera clock with that of a more accurate timepiece, and reset as required. 	4, 88
No indicators displayed in monitor.	Hide info is selected for Photo info in Monitor settings in the setup menu.	90
Date stamp not available.	Time zone and date has not been set in the setup menu.	88
Date not stamped on images even when Date stamp is enabled.	<ul style="list-style-type: none"> • The current shooting mode does not support Date stamp. • The date cannot be stamped on movies. 	92

Problem	Cause/Solution	
Screen for setting time zone and date is displayed when the camera is turned on.	The clock battery is exhausted; all settings were restored to their default values.	9, 10
The camera settings reset.		
The camera makes sound.	When Autofocus mode is set to Full-time AF or while in some shooting modes, the camera may produce an audible focusing sound.	17, 75, 84

Shooting Issues

Problem	Cause/Solution	
Cannot switch to shooting mode.	The camera cannot be switched to shooting mode while connected to a power outlet via the Charging AC Adapter.	104
Cannot take pictures or record movies.	<ul style="list-style-type: none"> When the camera is in playback mode, press the  button, shutter-release button, or  button. 	1, 14
	<ul style="list-style-type: none"> When menus are displayed, press the MENU button. 	64
	<ul style="list-style-type: none"> The flash is charging while the flash lamp is flashing. 	35
	<ul style="list-style-type: none"> The battery is exhausted. 	6, 7, 116
The camera cannot focus.	<ul style="list-style-type: none"> The subject is too close. Try shooting using scene auto selector mode, Close-up scene mode, or macro mode. The subject is hard to focus on. Set AF assist in the setup menu to Auto. Turn the camera off and then on again. 	17, 18, 19, 21, 39, 46, 94, –
Images are blurred.	<ul style="list-style-type: none"> Use the flash. Increase the ISO sensitivity value. Use Photo VR when taking still images, and use Movie VR when recording movies. Use a tripod to stabilize the camera (using the self-timer at the same time is more effective). 	35, 71, 85, 93, 37

Problem	Cause/Solution	
Streaks of light or partial discoloration are visible in the monitor.	Smear may occur when extremely bright light strikes the image sensor. When recording movies, avoiding bright objects, such as the sun, reflections of the sun, and electric lights is recommended.	62, 115
Bright specks appear in images captured with flash.	The flash is reflecting off particles in the air. Set the flash mode setting to  (off).	35
Flash does not fire.	<ul style="list-style-type: none"> • The flash mode is set to  (off). • A scene mode that restricts the flash is selected. • A function that restricts the flash is enabled. 	35 41 48
Optical zoom cannot be used.	Optical zoom cannot be used while recording movies.	62
Digital zoom cannot be used.	<ul style="list-style-type: none"> • Digital zoom is set to Off in the setup menu. • Digital zoom cannot be used with certain shooting modes or when using certain settings in other functions. 	94 49, 94
Image mode not available.	A function that restricts Image mode is enabled.	48
No sound when the shutter is released.	Off is selected for Shutter sound in Sound settings in the setup menu. No sound is produced with some shooting modes and settings, even when On is selected.	95
AF-assist illuminator does not light.	Off is selected for AF assist in the setup menu. AF-assist illuminator may not light depending on the position of the focus area or the current scene mode, even when Auto is selected.	94
Images appear smeared.	The lens is dirty. Clean the lens.	118
Colors are unnatural.	White balance or hue is not adjusted properly.	22, 68
Randomly spaced bright pixels ("noise") appear in image.	The subject is dark and the shutter speed is too slow, or ISO sensitivity is too high. Noise can be reduced by: <ul style="list-style-type: none"> • Using the flash • Specifying a lower ISO sensitivity setting 	35 71

Problem	Cause/Solution	
Randomly spaced bright pixels ("noise") appear in movies.	When recording movies in dim lighting, the image may contain noise. This occurs when the ISO sensitivity increases, and it does not indicate a malfunction.	–
Images are too dark (underexposed).	<ul style="list-style-type: none"> • The flash mode is set to  (off). • The flash window is blocked. • The subject is beyond the range of the flash. • Adjust exposure compensation. • Increase ISO sensitivity. • The subject is backlit. Select Backlighting scene mode or set the flash mode setting to  (fill flash). 	35 11 133 40 71 22, 35
Images are too bright (overexposed).	Adjust exposure compensation.	40
Unexpected results when flash set to  (auto with red-eye reduction).	Use any scene mode other than Night portrait , and change the flash mode to any setting other than  (auto with red-eye reduction) and try taking the picture again.	35, 41
Skin tones are not softened.	<ul style="list-style-type: none"> • In some shooting conditions, facial skin tones may not be softened. • For images containing four or more faces, try using the Skin softening effect in Glamour retouch in the playback menu. 	44 56
Saving images takes time.	<p>It may take more time to save images in the following situations:</p> <ul style="list-style-type: none"> • When the noise reduction function is in operation, such as when shooting in a dark environment • When the flash mode is set to  (auto with red-eye reduction) • When the skin softening function is applied while shooting • When using continuous shooting mode 	– 36 44, 76 70
Colored circles or light streaks appear in the monitor or images.	When shooting with backlighting or when a very strong light source (such as sunlight) is in the frame, colored circles or light streaks (ghosting) may occur. Change the position of the light source, or frame the image so that the light source does not enter the frame, and try again.	–

Playback Issues

Problem	Cause/Solution	
File cannot be played back.	<ul style="list-style-type: none"> • This camera may not be able to play back images saved with another make or model of digital camera. • This camera cannot play back movies recorded with another make or model of digital camera. • This camera may not be able to play back data edited on a computer. 	–
Cannot zoom in on image.	<ul style="list-style-type: none"> • Playback zoom cannot be used with movies. • For small images, the magnification rate displayed on the screen may not be compatible with the actual magnification rate. • This camera may not be able to zoom in on images captured with another make or model of digital camera. 	–
Cannot edit images.	<ul style="list-style-type: none"> • Some images cannot be edited. Images that have already been edited may not be edited again. • There is not enough free space on the memory card or in the internal memory. • This camera is unable to edit images captured with other cameras. • Editing functions used for images are not available for movies. 	26, 53 – – –
Images are not displayed on TV.	<ul style="list-style-type: none"> • Video mode is not correctly set in the setup menu. • The memory card contains no images. • Remove the memory card to play back images in the internal memory. 	64, 97 – 6
Nikon Transfer 2 does not start when the camera is connected to a computer.	<ul style="list-style-type: none"> • The camera is off. • The battery is exhausted. • The USB cable is not correctly connected. • The camera is not recognized by the computer. • The computer is not set to start Nikon Transfer 2 automatically. For more information about Nikon Transfer 2, refer to help information contained in ViewNX 2. 	– 98, 104 104, 111 – –

Problem	Cause/Solution	
The PictBridge startup screen is not displayed when the camera is connected to a printer.	With some PictBridge-compatible printers, the PictBridge startup screen may not be displayed and it may be impossible to print images when Auto is selected for Charge by computer in the setup menu. Set Charge by computer to Off and reconnect the camera to the printer.	64, 98
Images to be printed are not displayed.	<ul style="list-style-type: none"> • The memory card contains no images. • Remove the memory card to print images in the internal memory. 	– 6
Cannot select paper size with the camera.	<p>The camera cannot be used to select the paper size in the following situations, even when printing from a PictBridge-compatible printer. Use the printer to select the paper size.</p> <ul style="list-style-type: none"> • The printer does not support the paper sizes specified by the camera. • The printer automatically selects the paper size. 	–

File Names

Images or movies are assigned file names as follows.

File name: DSCN0001.JPG

(1) (2) (3)

(1) Identifier	Not shown on the screen of the camera. <ul style="list-style-type: none">• DSCN: Original still images, movies• SSCN: Small picture copies• RSCN: Cropped copies• FSCN: Images created by an image editing function other than crop and small picture
(2) File number	Assigned in ascending order, starting with "0001" and ending with "9999."
(3) Extension	Indicates file format. <ul style="list-style-type: none">• .JPG: Still images• .AVI: Movies

Optional Accessories

Battery charger

Battery Charger MH-66

It takes about 1 hour and 50 minutes to charge a fully exhausted battery.

AC adapter

AC Adapter EH-62G

(connect as shown)

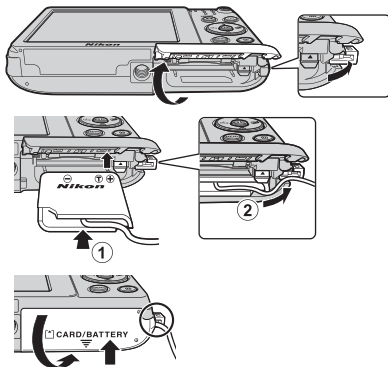

Make sure that the power connector cable is fully inserted in the power connector slot before inserting the AC adapter into the battery chamber. In addition, make sure that the power connector cable is fully inserted in the battery chamber slot before closing the battery-chamber/memory card slot cover. If part of the cable protrudes from the slots, the cover or cable may be damaged when the cover is closed.

Audio video cable

Audio Video Cable EG-CP14

Availability may vary with country or region.
See our website or brochures for the latest information.

Specifications

Nikon COOLPIX S3700 Digital Camera

Type	Compact digital camera
Number of effective pixels	20.1 million (Image processing may reduce the number of effective pixels.)
Image sensor	¹ /2.3-in. type CCD; approx. 20.48 million total pixels
Lens	NIKKOR lens with 8x optical zoom
Focal length	4.5–36.0 mm (angle of view equivalent to that of 25–200 mm lens in 35mm [135] format)
f/-number	f/3.7–6.6
Construction	8 elements in 7 groups
Digital zoom magnification	Up to 4x (angle of view equivalent to that of approx. 800 mm lens in 35mm [135] format)
Vibration reduction	Lens shift (still images) Lens shift and electronic VR (movies)
Autofocus (AF)	Contrast-detect AF
Focus range	<ul style="list-style-type: none">• [W]: Approx. 50 cm (1 ft 8 in.)–∞, [T]: Approx. 1.5 m (5 ft)–∞• Macro mode: Approx. 2 cm (0.8 in.)–∞ (wide-angle position) (All distances measured from center of front surface of lens)
Focus-area selection	Face priority, center, manual with 99 focus areas, subject tracking, target finding AF
Monitor	6.7 cm (2.7-in.), approx. 230k-dot, TFT LCD with anti-reflection coating and 5-level brightness adjustment
Frame coverage (shooting mode)	Approx. 97% horizontal and vertical (compared to actual picture)
Frame coverage (playback mode)	Approx. 99% horizontal and vertical (compared to actual picture)

Storage		
Media		Internal memory (approx. 25 MB), SD/SDHC/SDXC memory card
File system		DCF and Exif 2.3 compliant
File formats		Still images: JPEG Movies: AVI (Motion-JPEG compliant)
Image size (pixels)		<ul style="list-style-type: none"> • 20M (High) [5152 × 3864 ★] • 20M [5152 × 3864] • 10M [3648 × 2736] • 4M [2272 × 1704] • 2M [1600 × 1200] • VGA [640 × 480] • 16:9 (14M) [5120 × 2880] • 1:1 [3864 × 3864]
ISO sensitivity (Standard output sensitivity)		<ul style="list-style-type: none"> • ISO 80–1600 • ISO 3200 (available when using Auto mode)
Exposure		
Metering mode		Matrix, center-weighted (digital zoom less than 2×), spot (digital zoom 2× or more)
Exposure control		Programmed auto exposure and exposure compensation (-2.0 – +2.0 EV in steps of 1/3 EV)
Shutter		Mechanical and CCD electronic shutter
Speed		<ul style="list-style-type: none"> • 1/1500–1 s • 4 s (Fireworks show scene mode)
Aperture		Electronically-controlled ND filter (-3 AV) selection
Range		2 steps (f/3.7 and f/10.5 [W])
Self-timer		Can be selected from 10 s and 2 s
Flash		
Range (approx.) (ISO sensitivity: Auto)		[W]: 0.5–2.8 m (1 ft 8 in.–9 ft 2 in.) [T]: 1.5 m (4 ft 11 in.)
Flash control		TTL auto flash with monitor preflashes

Interface	
USB connector	Hi-Speed USB <ul style="list-style-type: none"> • Supports Direct Print (PictBridge) • Also used as audio/video output connector (NTSC or PAL can be selected for video output.)
Wi-Fi (Wireless LAN)	
Standards	IEEE 802.11b/g/n (standard wireless LAN protocol)
Range (line of sight)	Approx. 10 m (10 yd)
Operating frequency	2412–2462 MHz (1-11 channels)
Data rates (actual measured values)	IEEE 802.11b: 5 Mbps IEEE 802.11g: 20 Mbps IEEE 802.11n: 20 Mbps
Security	Open/WPA2
Access protocols	Infrastructure
Supported languages	Arabic, Bengali, Bulgarian, Chinese (Simplified and Traditional), Czech, Danish, Dutch, English, Finnish, French, German, Greek, Hindi, Hungarian, Indonesian, Italian, Japanese, Korean, Marathi, Norwegian, Persian, Polish, Portuguese (European and Brazilian), Romanian, Russian, Serbian, Spanish, Swedish, Tamil, Telugu, Thai, Turkish, Ukrainian, Vietnamese
Power sources	One Rechargeable Li-ion Battery EN-EL19 (included) AC Adapter EH-62G (available separately)
Charging time	Approx. 2 h 40 min (when using Charging AC Adapter EH-70P/EH-70PCH/EH-72P/EH-72PCH and when no charge remains)
Battery life¹	
Still images	Approx. 240 shots when using EN-EL19
Movies (actual battery life for recording) ²	Approx. 50 min when using EN-EL19
Tripod socket	1/4 (ISO 1222)
Dimensions (W × H × D)	Approx. 95.9 × 58.0 × 20.1 mm (3.8 × 2.3 × 0.8 in.) (excluding projections)
Weight	Approx. 118 g (4.2 oz) (including battery and memory card)

Operating environment

Temperature	0°C–40°C (32°F–104°F)
Humidity	85% or less (no condensation)

- Unless otherwise stated, all figures assume a fully-charged battery and an ambient temperature of $23 \pm 3^\circ\text{C}$ ($73.4 \pm 5.4^\circ\text{F}$) as specified by the Camera and Imaging Products Association (CIPA).
- ¹ Battery life may vary depending on conditions of use, such as the interval between shots or the length of time that menus and images are displayed.
 - ² Individual movie files cannot exceed 2 GB in size or 29 minutes in length. Recording may end before this limit is reached if camera temperature becomes elevated.

Rechargeable Li-ion Battery EN-EL19

Type	Rechargeable lithium-ion battery
Rated capacity	DC 3.7 V, 700 mAh
Operating temperature	0°C–40°C (32°F–104°F)
Dimensions (W × H × D)	Approx. 31.5 × 39.5 × 6 mm (1.3 × 1.6 × 0.3 in.)
Weight	Approx. 14.5 g (0.5 oz)

Charging AC Adapter EH-70P/EH-70PCH

Rated input	AC 100–240 V, 50/60 Hz, 0.07–0.044 A
Rated output	DC 5.0 V, 550 mA
Operating temperature	0°C–40°C (32°F–104°F)
Dimensions (W × H × D)	Approx. 55 × 22 × 54 mm (2.2 × 0.9 × 2.2 in.) (excluding plug adapter) For Argentina: Approx. 55 × 63 × 59 mm (2.2 × 2.5 × 2.4 in.) For India: Approx. 55 × 63.5 × 59 mm For Korea: Approx. 55 × 59 × 66.5 mm
Weight	Approx. 47 g (1.7 oz) (excluding plug adapter) For Argentina, India, and Korea: Approx. 72 g (2.6 oz)

Charging AC Adapter EH-72P/EH-72PCH

Rated input	AC 100–240 V, 50/60 Hz, 0.07–0.04 A
Rated output	DC 5.0 V, 550 mA
Operating temperature	0°C–40°C (32°F–104°F)
Dimensions (W × H × D)	Approx. 55 × 22 × 54 mm (2.2 × 0.9 × 2.2 in.) (excluding plug adapter) For Argentina: Approx. 55 × 63 × 59 mm (2.2 × 2.5 × 2.4 in.) For India: Approx. 55 × 63.5 × 59 mm For Korea: Approx. 55 × 67 × 59 mm
Weight	Approx. 46 g (1.7 oz) (excluding plug adapter) For Argentina, India, and Korea: Approx. 71 g (2.6 oz)

- Nikon will not be held liable for any errors this manual may contain.
- The appearance of this product and its specifications are subject to change without notice.

Approved Memory Cards

The following Secure Digital (SD) memory cards have been tested and approved for use in this camera.

- Memory cards with an SD Speed Class rating of 6 or faster are recommended for recording movies. When using a memory card with a lower Speed Class rating, movie recording may stop unexpectedly.

	SD memory card	SDHC memory card	SDXC memory card
SanDisk	–	4 GB, 8 GB, 16 GB, 32 GB	64 GB, 128 GB
TOSHIBA	–	4 GB, 8 GB, 16 GB, 32 GB	64 GB
Panasonic	2 GB	4 GB, 8 GB, 16 GB, 32 GB	64 GB
Lexar	–	8 GB, 16 GB, 32 GB	64 GB, 128 GB

- Contact the manufacturer for details on the above cards. We cannot guarantee camera performance when using memory cards made by other manufacturers.
- If you use a card reader, make sure that it is compatible with your memory card.

Trademark Information

- Windows is either a registered trademark or trademark of Microsoft Corporation in the United States and/or other countries.
- Adobe, the Adobe logo, and Reader are either trademarks or registered trademarks of Adobe Systems Incorporated in the United States and/or other countries.
- SDXC, SDHC, and SD Logos are trademarks of SD-3C, LLC.



- PictBridge is a trademark.
- Wi-Fi and the Wi-Fi logo are trademarks or registered trademarks of the Wi-Fi Alliance.
- Android and Google Play are trademarks or registered trademarks of Google, Inc.
- The N-Mark is a trademark or registered trademark of NFC Forum, Inc. in the United States and in other countries.
- All other trade names mentioned in this manual or the other documentation provided with your Nikon product are the trademarks or registered trademarks of their respective holders.

AVC Patent Portfolio License

This product is licensed under the AVC Patent Portfolio License for the personal and non-commercial use of a consumer to (i) encode video in compliance with the AVC standard (“AVC video”) and/or (ii) decode AVC video that was encoded by a consumer engaged in a personal and non-commercial activity and/or was obtained from a video provider licensed to provide AVC video. No license is granted or shall be implied for any other use. Additional information may be obtained from MPEG LA, L.L.C. See <http://www.mpegla.com>.

FreeType License (FreeType2)

- Portions of this software are copyright © 2012 The FreeType Project (<http://www.freetype.org>). All rights reserved.

MIT License (HarfBuzz)

- Portions of this software are copyright © 2015 The HarfBuzz Project (<http://www.freedesktop.org/wiki/Software/HarfBuzz>). All rights reserved.

Index

Symbols

 Scene auto selector mode 17, 19

 Scene mode 17, 20

 Special effects mode 17, 27

 Smart portrait mode 17, 29

 Auto mode 17, 33

 Playback mode 14

 List by date mode 52

 Wi-Fi options 64, 86

 Setup menu 64, 88

T (Telephoto) 13, 14

W (Wide-angle) 13, 14



 Playback zoom 14, 50

 Thumbnail playback 14, 51

 Help 20

 Shooting mode button 2, 17

 Playback button 2, 14

 ( movie-record) button 2, 18

 Apply selection button 2

MENU Menu button 2, 64

 Delete button 2, 15

 (Wi-Fi) button 1, 100, 101

 N-Mark 2, 102

 Flash mode 18, 35

 Self-timer 18, 37

 Macro mode 18, 39

 Exposure compensation 18, 40

AE/AF-L 25

A

AC adapter 104, 131

AF area mode 72

AF assist 1, 94

Aperture value 13

Audio video cable 105, 106, 131

Auto flash 36

Auto mode 17, 33

Auto off 12, 95

Auto with red-eye reduction 36

Autofocus 62, 75, 84

Autofocus mode 75, 84

B

Backlighting  20, 22

Battery 6, 7, 10, 135

Battery chamber 131

Battery charger 8, 131

Battery latch 6

Battery level indicator 10

Battery-chamber/memory card slot cover 2

Beach  20

Blink proof 77

Brightness 90

Built-in microphone 1

Button sound 95

C

Calendar Display 51

Charge by computer 98

Charge lamp 2

Charging 7, 98

Charging AC Adapter 7, 135, 136

Close-up  20, 21

Cloudy 68

Compression ratio 66







Computer 105, 111







Conformity Marking 99





Connect to smart device 86, 101

Connector cover 1

Continuous 70

Copying images.....	81	Fluorescent.....	68
Creative Slider	33	Focus.....	72
Crop.....	59	Focus area	43
Cross process 	27	Focus indicator	3, 12
Current settings	86	Focus lock	47
D		Food 	20, 22
Date and time	9, 88	Format internal memory.....	96
Date format.....	9, 88	Format memory cards.....	6, 96
Date stamp.....	92	Formatting.....	6, 96
Daylight.....	68	Full-frame playback.....	50
Daylight saving time	9, 10, 88	Full-time AF	75, 84
Delete	15	Functions that cannot be used simultaneously	48
Digital zoom.....	13, 94	G	
Direct print.....	107	Glamour retouch	29, 56
Disable Wi-Fi	86	H	
D-Lighting	55	Help.....	20
Dusk/dawn 	20	High-contrast monochrome 	27
Dynamic Fine Zoom.....	13		
E		I	
Editing images	53	Image mode	66
EH-70P/EH-70PCH	135	Image review.....	90
EH-72P/EH-72PCH	136	Image size	66
EN-EL19	135	Incandescent.....	68
Exposure compensation.....	40	Internal memory	6
Eyelet for camera strap.....	1	Internal memory indicator.....	3, 5
E		Interval	76
Face detection	43	ISO sensitivity	71
Face priority.....	72	L	
File names.....	130	Landscape 	20
Fill flash	36	Language.....	97
Fireworks show 	20, 22	Lens.....	1, 132
Firmware version.....	99	Lens cover	1
Fixed range auto.....	71	List by date mode	52
Flash	1, 35	M	
Flash lamp	2, 35	Macro mode	39
Flash mode	35, 36	Mark for Wi-Fi upload.....	78, 103
Flash off.....	36		

Memory card.....	117, 137	Pop POP	27
Memory card slot.....	6	Portrait 	20
Monitor.....	2, 3, 118	Power switch.....	1
Monitor settings.....	90	Power-on lamp.....	1
Movie menu.....	64, 83	Preset manual.....	69
Movie options.....	83	Pressing halfway.....	13
Movie playback.....	18, 63	Print.....	105, 108, 109
Movie recording.....	18, 60	Printer.....	105, 107
Movie VR.....	85	Protect.....	80
Multi selector.....	2, 64	Q	
N		Quick effects.....	53
NFC.....	102	Quick retouch.....	54
Night landscape 	20, 21	R	
Night portrait 	20	Rechargeable Li-ion battery.....	135
Nikon Transfer 2.....	112	Red-eye correction.....	55
Nostalgic sepia SE	27	Remaining movie recording time.....	60, 61
Number of exposures remaining.....	10, 67	Reset all.....	99
Number of shots.....	76	Restore default settings.....	86
O		Rotate image.....	80
Optical zoom.....	13	S	
Optional accessories.....	131	Scene mode.....	20
Options.....	86	SD memory card.....	117, 137
P		Selective color 	27
Panorama assist playback.....	26	Self-collage.....	31
Panorama assist 	20, 24	Self-timer.....	37
Paper size.....	108, 109	Self-timer lamp.....	1, 38
Party/indoor 	20, 21	Setup menu.....	64, 88
Pet portrait auto release.....	23	Shooting.....	11, 17
Pet portrait 	20, 23	Shooting menu.....	64, 66
Photo info.....	90	Shooting mode.....	17
Photo VR.....	93	Shutter sound.....	76, 95
PictBridge.....	105, 107	Shutter speed.....	13
Playback.....	14	Shutter-release button.....	1
Playback menu.....	64, 78	Single.....	70
Playback mode.....	14	Single AF.....	75, 84
Playback zoom.....	14, 50	Skin softening.....	44

Slide show	79	Wide-angle	13
Slow sync	36	Wi-Fi button.....	1, 100, 101
Small picture	58	Wi-Fi options	64, 86
Smart portrait menu.....	64, 76	Wind noise reduction	85
Smart portrait mode	29	Wireless LAN.....	100
Smile timer.....	30	Wireless Mobile Utility	100
Snow 	20	Z	
Soft SO	27	Zoom control.....	1, 13
Sound settings.....	95	Zooming in/out.....	13
Speaker	2		
Special effects mode.....	27		
Sports 	20, 21		
Strap	ii		
Subject tracking	73, 74		
Sunset 	20		
I			
Target finding AF.....	45, 73		
Telephoto	13		
Televisions	105, 106		
Thumbnail display	14, 51		
Time difference	88		
Time zone	10, 88		
Time zone and date.....	9, 88		
Toy camera effect 1 	27		
Toy camera effect 2 	27		
Tripod socket	2, 134		
U			
Upload from camera.....	86		
USB cable	7, 105, 107, 111		
USB/audio/video output connector	1		
V			
Video mode	97		
ViewNX 2	111		
Volume	63		
W			
White balance	68		

No reproduction in any form of this manual, in whole or in part (except for brief quotation in critical articles or reviews), may be made without written authorization from NIKON CORPORATION.

NIKON CORPORATION

© 2015 Nikon Corporation



YP6B06(11)
6MN53311-06