

Nikon

DIGITAL CAMERA

1 J5

User's Manual

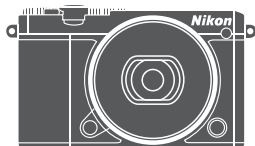

Nikon Manual Viewer 2





Install the Nikon Manual Viewer 2 app on your smartphone or tablet to view Nikon digital camera manuals, anytime, anywhere.

Nikon Manual Viewer 2 can be downloaded free of charge from the App Store and Google Play.

En

Table of Contents

Touch Controls	iv
About This Manual	v
The Reference Manual	vi
For Your Safety	vii
Notices	x
Wireless	xvi
Introduction	1
The Camera and Accessories	1
Parts of the Camera	2
Using the Touch Screen	13
First Steps	18
Taking and Viewing Photographs	25
Point-and-Shoot Photography (Auto Mode)	25
Viewing Photographs	28
Deleting Pictures	29
Recording and Viewing Movies	32
Recording Movies	32
Taking Photographs During Movie Recording	35
Viewing Movies	36
Deleting Movies	37
 Advanced Movie Options	38

 Choosing a Creative Mode	41
Choosing a Mode That Matches the Subject or Situation	42
HDR	44
Easy Panorama.....	45
Selective Color	48
Taking Photos in P, S, A, and M Modes	49
P Programmed Auto	49
S Shutter-Priority Auto	50
A Aperture-Priority Auto	51
M Manual.....	52
 Photographing Subjects in Motion (Sports Mode)	53
 Choosing the Moment (Best Moment Capture)	55
Choosing a Shot Manually (Active Selection).....	55
Choosing Your Moment (Slow View).....	59
Letting the Camera Choose the Moment (Smart Photo Selector).....	61
 Combining Photos with Brief Movie Vignettes (Motion Snapshot Mode)	65
Viewing Motion Snapshots	69
Deleting Motion Snapshots	69

More on Photography **70**

Live Image Control	70
Continuous Mode	73
Self-Timer Modes.....	75
The Built-in Flash	77
Auto Pop-up Modes	77
Manual Pop-up Modes	79
Self-Portraits.....	83
Tap Shooting Options.....	86
📷 Auto, 📷 Creative, and Self-Portrait Modes	86
🏃 Sports Mode	86
P, S, A, and M Modes.....	87
🎬+ Advanced Movie Mode.....	88

Wi-Fi **89**

What Wi-Fi Can Do for You	89
Wireless Security.....	90
Connecting via Wi-Fi.....	93
Android and iOS: Connecting via SSID	93
Android: Connecting via NFC	94
Uploading Photos to a Smart Device.....	96
Uploading Photos One at a Time	96
Uploading Multiple Selected Photos	97
Uploading Photos via NFC	98
Downloading Selected Pictures to the Smart Device.....	99

Menu Options **100**

Connecting to a Computer **104**

Copying Pictures to a Computer	104
Installing ViewNX-i.....	104
Copying Pictures to the Computer	105

Optional Accessories	108
Approved Memory Cards.....	109
Storage and Cleaning	110
Storage	110
Cleaning	110
Caring for the Camera and Battery: Cautions.....	111
Troubleshooting.....	116
Battery/Display	116
Shooting (All Modes).....	116
Movies.....	117
Tap Shooting Options.....	117
Playback	118
Wi-Fi (Wireless Networks)	118
Miscellaneous	118
Error Messages.....	119
Specifications.....	121
Nikon 1 J5 Digital Camera	121
Battery Life	132
Index.....	133

Touch Controls

Touch controls can be used for photography and a variety of other operations (☞ 13).

Photographs

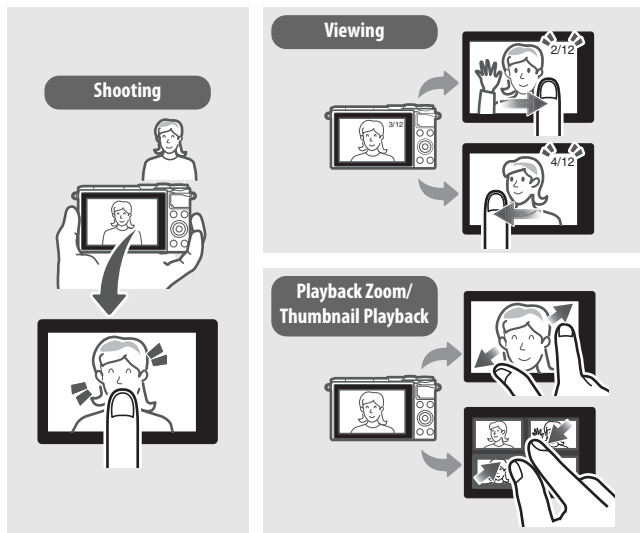

Movies

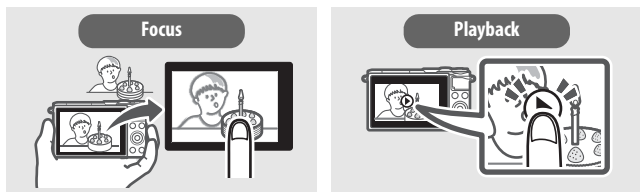

In addition to the functions listed above, touch controls can be used to adjust settings and navigate the menus.

About This Manual

For a complete guide to using your digital camera, see the *Reference Manual* (page vi). To get the most from your camera, please be sure to read this *User's Manual* thoroughly and keep it where it will be read by all who use the product.

Camera Settings

The explanations in this manual assume that default settings are used.

Symbols and Conventions

To make it easier to find the information you need, the following symbols and conventions are used:



This icon marks cautions; information that should be read before use to prevent damage to the camera.



This icon marks notes; information that should be read before using the camera.



This icon marks references to other pages in this manual.

The lens generally used in this manual for illustrative purposes is a 1 NIKKOR VR 10–30mm f/3.5–5.6 PD-ZOOM.

Nikon User Support

If you need any technical assistance with the operation of your Nikon product(s), please contact one of the Nikon representatives. For information on the Nikon representatives in your area, please visit <http://www.nikon-asia.com/support>.

For Your Safety

Before using the camera for the first time, read the safety instructions in "For Your Safety" (☞ vii–ix) and "Caring for the Camera and Battery: Cautions" (☞ 111).

The Reference Manual

For more information on using your Nikon camera, download a pdf copy of the camera *Reference Manual* from the website listed below. The *Reference Manual* can be viewed using Adobe Reader or Adobe Acrobat Reader 5.0 or later.

- 1 On your computer, launch a web browser and visit <http://downloadcenter.nikonimglib.com/>
- 2 Navigate to the page for the desired product and download the manual.

For Your Safety

To prevent damage to your Nikon product or injury to yourself or to others, read the following safety precautions in their entirety before using this equipment. Keep these safety instructions where all those who use the product will read them.

The consequences that could result from failure to observe the precautions listed in this section are indicated by the following symbol:



This icon marks warnings. To prevent possible injury, read all warnings before using this Nikon product.

■ WARNINGS

- ⚠ **Keep the sun out of the frame.** Keep the sun well out of the frame when shooting backlit subjects. Sunlight focused into the camera when the sun is in or close to the frame could cause a fire.
- ⚠ **Turn off immediately in the event of malfunction.** Should you notice smoke or an unusual smell coming from the equipment or AC adapter (available separately), unplug the AC adapter and remove the battery immediately, taking care to avoid burns. Continued operation could result in injury. After removing the battery, take the equipment to a Nikon-authorized service center for inspection.
- ⚠ **Do not use in the presence of flammable gas.** Do not use electronic equipment in the presence of flammable gas, as this could result in explosion or fire.
- ⚠ **Keep dry.** Do not immerse in or expose to water or handle with wet hands. Failure to keep the product dry could result in damage to the product, fire, or electric shock, while handling the product with wet hands could result in electric shock.
- ⚠ **Do not disassemble.** Touching the product's internal parts could result in injury. In the event of malfunction, the product should be repaired only by a qualified technician. Should the product break open as the result of a fall or other accident, remove the battery and/or AC adapter and then take the product to a Nikon-authorized service center for inspection.
- ⚠ **Keep out of reach of children.** Failure to observe this precaution could result in injury. In addition, note that small parts constitute a choking hazard. Should a child swallow any part of this equipment, consult a physician immediately.
- ⚠ **Do not place the strap around the neck of an infant or child.** Placing the camera strap around the neck of an infant or child could result in strangulation.
- ⚠ **Follow the instructions of airline and hospital personnel.**

- ⚠ Do not remain in contact with the camera, battery, or charger for extended periods while the devices are on or in use.** Parts of the device become hot. Leaving the device in direct contact with the skin for extended periods may result in low-temperature burns.
- ⚠ Do not leave the product where it will be exposed to extremely high temperatures, such as in an enclosed automobile or in direct sunlight.** Failure to observe this precaution could cause damage or fire.
- ⚠ Do not aim the flash at the operator of a motor vehicle.** Failure to observe this precaution could result in accidents.
- ⚠ Observe caution when using a flash.**
- Using the camera with the flash in close contact with the skin or other objects could cause burns.
 - Using a flash close to the subject's eyes could cause temporary visual impairment. The flash should be no less than one meter (3 ft 4 in.) from the subject. Particular care should be observed when photographing infants.
- ⚠ Avoid contact with liquid crystal.** Should the display break, care should be taken to avoid injury due to broken glass and to prevent the liquid crystal from the display touching the skin or entering the eyes or mouth.
- ⚠ Do not carry tripods with a lens or camera attached.** You could trip or accidentally strike others, resulting in injury.
- ⚠ Do not touch the moving parts of the lens.** Failure to observe this precaution could result in injury.
- ⚠ Observe proper precautions when handling batteries.** Batteries may leak, overheat, rupture, or catch fire if improperly handled. Observe the following precautions when handling batteries for use in this product:
- Use only batteries approved for use in this equipment.
 - Do not short or disassemble the battery.
 - Do not expose the battery or the camera in which it is inserted to powerful physical shocks.
 - Be sure the product is off before replacing the battery. If you are using an AC adapter, be sure it is unplugged.
 - Do not attempt to insert the battery upside down or backwards.
 - Do not expose the battery to flame or to excessive heat.
 - Do not immerse in or expose to water.
 - Replace the terminal cover when transporting the battery. Do not transport or store the battery with metal objects such as necklaces or hairpins.
 - Batteries are prone to leakage when fully discharged. To avoid damage to the product, be sure to remove the battery when no charge remains.
 - When the battery is not in use, attach the terminal cover and store in a cool, dry place.

- The battery may be hot immediately after use or when the product has been used on battery power for an extended period. Before removing the battery turn the camera off and allow the battery to cool.
- Discontinue use immediately should you notice any changes in the battery, such as discoloration or deformation.

⚠ Observe proper precautions when handling the charger:

- Keep dry. Failure to observe this precaution could result in injury or product malfunction due to fire or electric shock.
- Do not short the charger terminals. Failure to observe this precaution could result in overheating and damage to the charger.
- Dust on or near the metal parts of the plug should be removed with a dry cloth. Continued use could result in fire.
- Do not go near the charger during thunderstorms. Failure to observe this precaution could result in electric shock.
- Do not handle the plug or charger with wet hands. Failure to observe this precaution could result in injury or product malfunction due to fire or electric shock.
- Do not use with travel converters or adapters designed to convert from one voltage to another or with DC-to-AC inverters. Failure to observe this precaution could damage the product or cause overheating or fire.

⚠ Use appropriate cables. When connecting cables to the input and output jacks, use only the cables provided or sold by Nikon for the purpose to maintain compliance with product regulations.

Notices

- No part of the manuals included with this product may be reproduced, transmitted, transcribed, stored in a retrieval system, or translated into any language in any form, by any means, without Nikon's prior written permission.
- Nikon reserves the right to change the specifications of the hardware and software described in these manuals at any time and without prior notice.
- Nikon will not be held liable for any damages resulting from the use of this product.
- While every effort has been made to ensure that the information in these manuals is accurate and complete, we would appreciate it were you to bring any errors or omissions to the attention of the Nikon representative in your area (address provided separately).

Notice for Customers in Canada

CAN ICES-3 (B) / NMB-3 (B)

Notice for Customers in Europe

CAUTION: RISK OF EXPLOSION IF BATTERY IS REPLACED BY AN INCORRECT TYPE. DISPOSE OF USED BATTERIES ACCORDING TO THE INSTRUCTIONS.

This symbol indicates that electrical and electronic equipment is to be collected separately.



The following apply only to users in European countries:

- This product is designated for separate collection at an appropriate collection point. Do not dispose of as household waste.
- Separate collection and recycling helps conserve natural resources and prevent negative consequences for human health and the environment that might result from incorrect disposal.
- For more information, contact the retailer or the local authorities in charge of waste management.

This symbol on the battery indicates that the battery is to be collected separately.



The following apply only to users in European countries:

- All batteries, whether marked with this symbol or not, are designated for separate collection at an appropriate collection point. Do not dispose of as household waste.
- For more information, contact the retailer or the local authorities in charge of waste management.

Notice for Customers in the U.S.A.

The Battery Charger

IMPORTANT SAFETY INSTRUCTIONS—SAVE THESE INSTRUCTIONS

DANGER—TO REDUCE THE RISK OF FIRE OR ELECTRIC SHOCK, CAREFULLY FOLLOW THESE INSTRUCTIONS

For connection to a supply not in the U.S.A., use an attachment plug adapter of the proper configuration for the power outlet if needed. This power unit is intended to be correctly oriented in a vertical or floor mount position.

Federal Communications Commission (FCC) Radio Frequency Interference Statement

This equipment has been tested and found to comply with the limits for a Class B digital device, pursuant to Part 15 of the FCC rules. These limits are designed to provide reasonable protection against harmful interference in a residential installation. This equipment generates, uses, and can radiate radio frequency energy and, if not installed and used in accordance with the instructions, may cause harmful interference to radio communications. However, there is no guarantee that interference will not occur in a particular installation. If this equipment does cause harmful interference to radio or television reception, which can be determined by turning the equipment off and on, the user is encouraged to try to correct the interference by one or more of the following measures:

- Reorient or relocate the receiving antenna.
- Increase the separation between the equipment and receiver.
- Connect the equipment into an outlet on a circuit different from that to which the receiver is connected.
- Consult the dealer or an experienced radio/television technician for help.



Nikon
1 J5

CAUTIONS

Modifications

The FCC requires the user be notified that any changes or modifications made to this device that are not expressly approved by Nikon Corporation may void the user's authority to operate the equipment.

Interface Cables

Use the interface cables sold or provided by Nikon for your equipment. Using other interface cables may exceed the limits of Class B Part 15 of the FCC rules.

Notice for Customers in the State of California

WARNING: Handling the cord on this product may expose you to lead, a chemical known to the State of California to cause birth defects or other reproductive harm. *Wash hands after handling.*

Nikon Inc., 1300 Walt Whitman Road,
Melville, New York 11747-3064, U.S.A.
Tel.: 631-547-4200

Notice Concerning Prohibition of Copying or Reproduction

Note that simply being in possession of material that has been digitally copied or reproduced by means of a scanner, digital camera, or other device may be punishable by law.

• Items prohibited by law from being copied or reproduced

Do not copy or reproduce paper money, coins, securities, government bonds, or local government bonds, even if such copies or reproductions are stamped "Sample."

The copying or reproduction of paper money, coins, or securities which are circulated in a foreign country is prohibited.

Unless the prior permission of the government has been obtained, the copying or reproduction of unused postage stamps or post cards issued by the government is prohibited.

The copying or reproduction of stamps issued by the government and of certified documents stipulated by law is prohibited.

• Cautions on certain copies and reproductions

The government has issued cautions on copies or reproductions of securities issued by private companies (shares, bills, checks, gift certificates, etc.), commuter passes, or coupon tickets, except when a minimum of necessary copies are to be provided for business use by a company. Also, do not copy or reproduce passports issued by the government, licenses issued by public agencies and private groups, ID cards, and tickets, such as passes and meal coupons.

• Comply with copyright notices

The copying or reproduction of copyrighted creative works such as books, music, paintings, woodcuts, prints, maps, drawings, movies, and photographs is governed by national and international copyright laws. Do not use this product for the purpose of making illegal copies or to infringe copyright laws.

Disposing of Data Storage Devices

Please note that deleting images or formatting memory cards or other data storage devices does not completely erase the original image data. Deleted files can sometimes be recovered from discarded storage devices using commercially available software, potentially resulting in the malicious use of personal image data. Ensuring the privacy of such data is the user's responsibility.

Before discarding a data storage device or transferring ownership to another person, erase all data using commercial deletion software, or format the device and then completely refill it with images containing no private information (for example, pictures of empty sky). Wi-Fi settings can be reset to default values by selecting **Reset Wi-Fi settings** for **Wi-Fi connection type** in the Wi-Fi menu (□ 92). Care should be taken to avoid injury when physically destroying data storage devices.

AVC Patent Portfolio License

THIS PRODUCT IS LICENSED UNDER THE AVC PATENT PORTFOLIO LICENSE FOR THE PERSONAL AND NON-COMMERCIAL USE OF A CONSUMER TO (i) ENCODE VIDEO IN COMPLIANCE WITH THE AVC STANDARD ("AVC VIDEO") AND/OR (ii) DECODE AVC VIDEO THAT WAS ENCODED BY A CONSUMER ENGAGED IN A PERSONAL AND NON-COMMERCIAL ACTIVITY AND/OR WAS OBTAINED FROM A VIDEO PROVIDER LICENSED TO PROVIDE AVC VIDEO. NO LICENSE IS GRANTED OR SHALL BE IMPLIED FOR ANY OTHER USE. ADDITIONAL INFORMATION MAY BE OBTAINED FROM MPEG LA, L.L.C. SEE <http://www.mpegla.com>

Temperature Warnings

The camera may become warm to the touch during use; this is normal and does not indicate a malfunction. At high ambient temperatures, after extended periods of continuous use, or after several photographs have been taken in quick succession, a temperature warning may be displayed, following which the camera will turn off automatically to minimize damage to its internal circuits. Wait for the camera to cool before resuming use.

Use Only Nikon Brand Electronic Accessories

Nikon cameras are designed to the highest standards and include complex electronic circuitry. Only Nikon brand electronic accessories (including chargers, batteries, AC adapters, and lens accessories) certified by Nikon specifically for use with this Nikon digital camera are engineered and proven to operate within the operational and safety requirements of this electronic circuitry.

The use of non-Nikon electronic accessories could damage the camera and may void your Nikon warranty. The use of third-party rechargeable Li-ion batteries not bearing the Nikon holographic seal shown at right could interfere with normal operation of the camera or result in the batteries overheating, igniting, rupturing, or leaking.



For more information about Nikon brand accessories, contact a local authorized Nikon dealer.

✔ Use Only Nikon Brand Accessories

Only Nikon brand accessories certified by Nikon specifically for use with your Nikon digital camera are engineered and proven to operate within its operational and safety requirements. THE USE OF NON-NIKON ACCESSORIES COULD DAMAGE YOUR CAMERA AND MAY VOID YOUR NIKON WARRANTY.

✔ Servicing the Camera and Accessories

The camera is a precision device and requires regular servicing. Nikon recommends that the camera be inspected by the original retailer or a Nikon-authorized service representative once every one to two years, and that it be serviced once every three to five years (note that fees apply to these services). Frequent inspection and servicing are particularly recommended if the camera is used professionally. Any accessories regularly used with the camera, such as lenses, should be included when the camera is inspected or serviced.

✍ Before Taking Important Pictures

Before taking pictures on important occasions (such as at weddings or before taking the camera on a trip), take a test shot to ensure that the camera is functioning normally. Nikon will not be held liable for damages or lost profits that may result from product malfunction.

✍ Life-Long Learning

As part of Nikon's "Life-Long Learning" commitment to ongoing product support and education, continually-updated information is available on-line at the following sites:

- **For users in the U.S.A.:** <http://www.nikonusa.com/>
- **For users in Europe and Africa:** <http://www.europe-nikon.com/support/>
- **For users in Asia, Oceania, and the Middle East:** <http://www.nikon-asia.com/>

Visit these sites to keep up-to-date with the latest product information, tips, answers to frequently-asked questions (FAQs), and general advice on digital imaging and photography. Additional information may be available from the Nikon representative in your area. For contact information, visit <http://imaging.nikon.com/>

Wireless

This product, which contains encryption software developed in the United States, is controlled by the United States Export Administration Regulations and may not be exported or re-exported to any country to which the United States embargoes goods. The following countries are currently subject to embargo: Cuba, Iran, North Korea, Sudan, and Syria.

The use of wireless devices may be prohibited in some countries or regions. Contact a Nikon-authorized service representative before using the wireless features of this product outside the country of purchase.

Notices for Customers in the U. S. A.

This device complies with Part 15 of FCC Rules and Industry Canada licence-exempt RSS standard(s). Operation is subject to the following two conditions: (1) this device may not cause interference, and (2) this device must accept any interference, including interference that may cause undesired operation of the device.

FCC WARNING

The FCC requires the user to be notified that any changes or modifications made to this device that are not expressly approved by Nikon Corporation may void the user's authority to operate the equipment.

FCC Radio Frequency Interference Statement

Note: This equipment has been tested and found to comply with the limits for a Class B digital device, pursuant to part 15 of the FCC Rules. These limits are designed to provide reasonable protection against harmful interference in a residential installation. This equipment generates, uses and can radiate radio frequency energy and, if not installed and used in accordance with the instructions, may cause harmful interference to radio communications. However, there is no guarantee that interference will not occur in a particular installation. If this equipment does cause harmful interference to radio or television reception, which can be determined by turning the equipment off and on, the user is encouraged to try to correct the interference by one or more of the following measures:

- Reorient or relocate the receiving antenna.
- Increase the separation between the equipment and receiver.
- Connect the equipment into an outlet on a circuit different from that to which the receiver is connected.
- Consult the dealer or an experienced radio/TV technician for help.

Co-location

This transmitter must not be co-located or operated in conjunction with any other antenna or transmitter.

Nikon Inc., 1300 Walt Whitman Road, Melville, New York 11747-3064, U.S.A.

Tel.: 631-547-4200

Notices for Customers in Canada

This device complies with Part 15 of FCC Rules and Industry Canada licence-exempt RSS standard(s). Operation is subject to the following two conditions: (1) this device may not cause interference, and (2) this device must accept any interference, including interference that may cause undesired operation of the device.

FCC/IC RF Exposure Statement

The available scientific evidence does not show that any health problems are associated with using low power wireless devices. There is no proof, however, that these low power wireless devices are absolutely safe. Low power Wireless devices emit low levels of radio frequency energy (RF) in the microwave range while being used. Whereas high levels of RF can produce health effects (by heating tissue), exposure of low-level RF that does not produce heating effects causes no known adverse health effects. Many studies of low-level RF exposures have not found any biological effects. Some studies have suggested that some biological effects might occur, but such findings have not been confirmed by additional research. The 1 J5, which is equipped with a DW092 (FCC ID:EW4DW092 / IC ID:4634A-3149EC) wireless LAN module, has been tested and found to comply with FCC/IC radiation exposure limits set forth for an uncontrolled environment and meets the FCC radio frequency (RF) Exposure Guidelines in Supplement C to OET65 and RSS-102 of the IC radio frequency (RF) Exposure rules. Please refer to the SAR test report that was uploaded to FCC website.

Notices for Customers in Europe

Hereby, Nikon Corporation, declares that the 1 J5 is in compliance with the essential requirements and other relevant provisions of Directive 1999/5/EC. The declaration of conformity may be consulted at http://imaging.nikon.com/support/pdf/DoC_1J5.pdf



Notice for Customers in Singapore

Trade Name: Nikon Model: 1 J5

This device complies with radio-frequency regulations. The content of certification labels not affixed to the device is given below.

Complies with IDA Standards DA103423
--

Notice for Customers in Algeria

This device complies with Part 15 of FCC Rules and Industry Canada licence-exempt RSS standard(s). Operation is subject to the following two conditions: (1) this device may not cause interference, and (2) this device must accept any interference, including interference that may cause undesired operation of the device.

Co-location

This transmitter must not be co-located or operated in conjunction with any other antenna or transmitter.

FCC/IC RF Exposure Statement

The available scientific evidence does not show that any health problems are associated with using low power wireless devices. There is no proof, however, that these low power wireless devices are absolutely safe. Low power Wireless devices emit low levels of radio frequency energy (RF) in the microwave range while being used. Whereas high levels of RF can produce health effects (by heating tissue), exposure of low-level RF that does not produce heating effects causes no known adverse health effects. Many studies of low-level RF exposures have not found any biological effects. Some studies have suggested that some biological effects might occur, but such findings have not been confirmed by additional research. The 1 J5, which is equipped with a DW092 (FCC ID:EW4DW092 / IC ID:4634A-3149EC) wireless LAN module, has been tested and found to comply with FCC/IC radiation exposure limits set forth for an uncontrolled environment and meets the FCC radio frequency (RF) Exposure Guidelines in Supplement C to OET65 and RSS-102 of the IC radio frequency (RF) Exposure rules. Please refer to the SAR test report that was uploaded to FCC website.

Security

Although one of the benefits of this product is that it allows others to freely connect for the wireless exchange of data anywhere within its range, the following may occur if security is not enabled:

- Data theft: Malicious third-parties may intercept wireless transmissions to steal user IDs, passwords, and other personal information.
- Unauthorized access: Unauthorized users may gain access to the network and alter data or perform other malicious actions. Note that due the design of wireless networks, specialized attacks may allow unauthorized access even when security is enabled.

Introduction

The Camera and Accessories

The following items are included with purchase of this product or are available separately. Confirm that the package contains all items listed as included. For a complete list of the accessories available for separate purchase, see page 108.



Body Cap BF-N1000 (included)

Digital Camera Nikon 1 J5 (included)

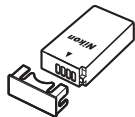

Rechargeable Li-ion Battery EN-EL24 (included with terminal cover)



Lens (supplied only if lens kit is purchased with camera)



Battery Charger MH-31 (included; plug adapter supplied in countries or regions where required; shape depends on country of sale)

Also included:

- Strap AN-N1000
- USB Cable UC-E20
- Warranty
- User's Manual (this manual)

Memory cards are sold separately.



Parts of the Camera

Take a few moments to familiarize yourself with camera controls and displays. You may find it helpful to bookmark this section and refer to it as you read through the rest of the manual.

The Camera Body

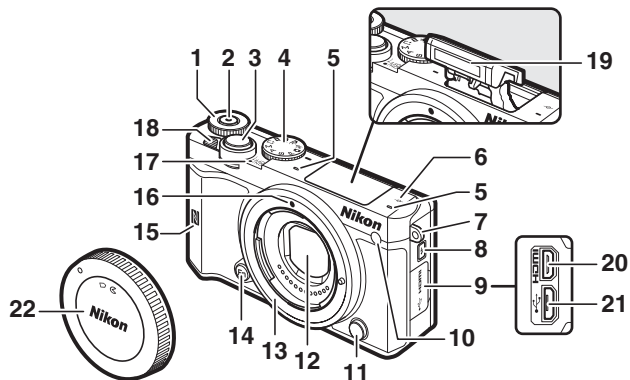

1 Command dial	28	11 Lens release button	
2 Movie-record button	33	12 Dust shield.....	110, 111
3 Shutter-release button.....	30, 35	13 Lens mount	20
4 Mode dial	6	14 Fn button	
5 Microphone.....	101	15 N-Mark (NFC antenna).....	94
6 Focal plane mark (∅)		16 Mounting mark	20
7 Eyelet for camera strap.....	18	17 Power lamp	22
8 Flash pop-up button	79	18 Power switch.....	22
9 Connector cover		19 Built-in flash.....	77
10 AF-assist illuminator	102	20 HDMI connector	
Self-timer lamp.....	76	21 USB connector.....	105
Red-eye reduction lamp	78, 80	22 Body cap	108

The Camera Body (Continued)

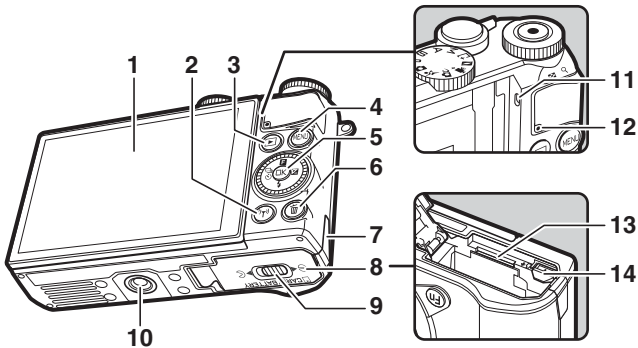

1 Tilting monitor	4, 11, 13, 83	7 Power connector cover for optional power connector	
2 (Wi-Fi) button	93, 96	8 Battery-chamber/ memory card slot cover	19
3 (playback) button	28	9 Battery-chamber/ memory card slot cover latch.....	19
4 MENU (menu) button	8	10 Tripod socket *	
5 Multi selector.....	9	11 Speaker	
(OK) button.....	9	12 Memory card access lamp.....	27
(feature)	10	13 Memory card slot.....	19
(exposure compensation)		14 Battery latch.....	19
(flash mode).....	77		
(continuous shooting/ self-timer).....	73, 75		
6 (delete) button.....	29		

* Camera does not support TA-N100 tripod mounting spacer.

Holding the Camera

When framing photographs, hold the camera as shown below.

*Hold the camera in
your right hand.*

*Keep your elbows
propped lightly
against your torso.*

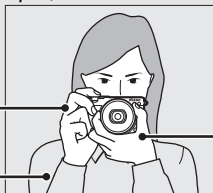

*Cradle the lens with
your left hand.*

The Monitor

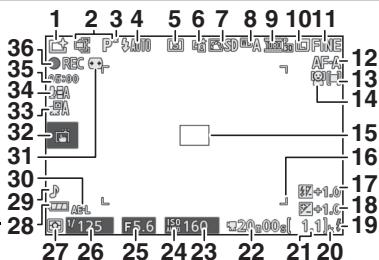
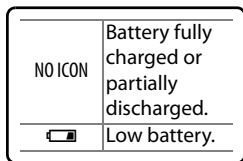

1 Shooting mode	6	20 "k" (appears when memory remains for over 1000 exposures)	
2 Live image control	70	21 Number of exposures remaining	24
Creative mode	41	Number of shots remaining	
Best moment capture selection	55	before memory buffer fills	
Advanced movie selection	38	White balance recording indicator	
Exposure mode	101	Card warning indicator	119
3 Flexible program indicator	49	22 Time available	33
4 Flash mode	78, 80	23 ISO sensitivity	101
5 Self-timer	75	24 ISO sensitivity indicator	101
Continuous mode *	53, 73	Auto ISO sensitivity indicator	
6 Active D-Lighting *	101	25 Aperture	51, 52
7 Picture Control *	101	26 Shutter speed	50, 52
8 White balance *	101	27 Metering	101
9 Frame size/frame rate *	101	28 Battery indicator *	
10 Image size *	101	29 Sound settings *	102
11 Image quality *	101	30 Autoexposure (AE) lock indicator	
12 Focus mode *	102	31 Auto distortion control	101
13 AF-area mode *	102	32 Tap shooting options	86
14 Face-priority *	31, 102	33 Auto image capture	101
15 Focus area	26, 102	34 Microphone sensitivity *	
16 AF-area brackets *		35 Time elapsed	33
17 Flash compensation	102	36 Recording indicator	33
18 Exposure compensation			
19 Flash-ready indicator	81		

* Available only when **Detailed** is selected for **Display > Shooting** in the setup menu (□ 102).

Note: Display shown with all indicators lit for illustrative purposes.

Recording Area

The area recorded during movie recording is shown by guides in the display; the appearance of the guides depends on the option selected for **Electronic VR (movies)** (p. 102) in shooting menu.

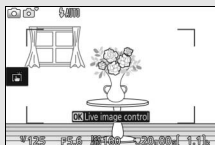

Electronic vibration reduction on

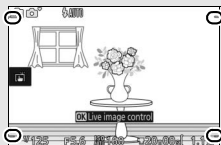

Electronic vibration reduction off



The Mode Dial

The camera offers a choice of the following shooting modes:

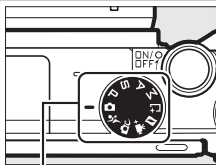



Mode dial

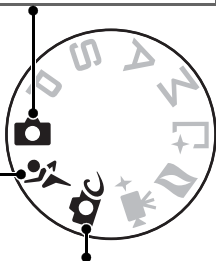

 **Auto mode** (📖 25): Let the camera pick the settings for photographs and movies.

 **Sports mode** (📖 53): The camera takes pictures continuously while the shutter-release button is pressed. Choose for sporting events and other scenes with fast-moving subjects.



 **Creative mode** (📖 41): Use special effects or match settings to the scene.

POP Pop

RETRO Retro

 High-contrast monochrome

SEPIA Nostalgic sepia

 HDR HDR

 Soft

 Easy panorama

 Miniature effect

 Selective color

 Cross process

 Toy camera effect

 Cross screen

 Fisheye

 Skin softening

 Night landscape

 Night portrait

 Landscape

 Close-up

 Portrait

P, S, A, and M modes (☞ 49): Control shutter speed and aperture for advanced photographic effects.

- **P:** Programmed auto (☞ 49)
- **S:** Shutter-priority auto (☞ 50)
- **A:** Aperture-priority auto (☞ 51)
- **M:** Manual (☞ 52)

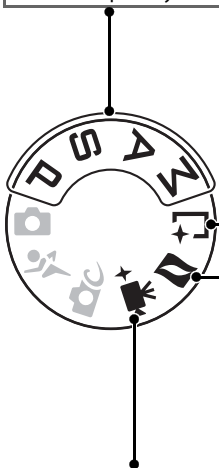

☞ Best moment capture mode (☞ 55): Choose **Active Selection** to select the best picture from 20 shots in temporary storage, **Slow view** to choose the best timing for the shot while the scene plays back in slow motion, or **Smart Photo Selector** to let the camera pick the best shot based on composition and movement.

☞ Motion Snapshot mode (☞ 65): Each time the shutter is released, the camera records a still image and about 1.6 s of movie footage. When the resulting "Motion Snapshot" is viewed on the camera, the movie will play back in slow motion over approximately 4 s, followed by the still image.

☞+ Advanced movie mode (☞ 38): Choose an exposure mode and adjust shutter-speed or aperture or record movies in slow or fast motion or with other special effects.

The MENU Button

Most shooting, playback, setup, and Wi-Fi options can be accessed from the camera menus. To view the menus, press the MENU button.

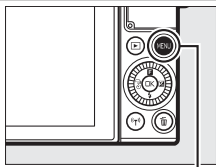

MENU button

Tabs

Choose from the following menus:

Playback menu (📖 100)

Shooting menu (📖 101)

Setup menu (📖 102)

Wi-Fi menu (📖 89, 103)

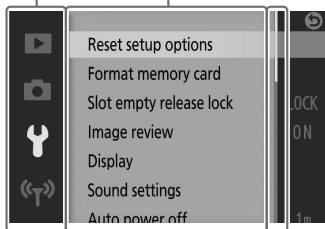

Menu options
Options in current menu.

Slider shows position in
current menu.

Using the Menus

The items listed may vary with camera settings. Items displayed in gray are not currently available. To exit the menus and return to shooting mode, press the shutter-release button halfway (📖 30).

■ Using the Menus

Use the multi selector to navigate the playback, shooting, setup, and Wi-Fi menus.

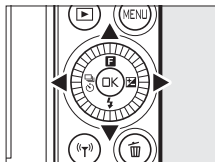

Multi selector

1 Select a menu.

Press or to highlight tabs and press to position the cursor in the highlighted menu.



2 Select an item.

Press or to highlight menu items and press to view options for the highlighted item.



3 Select an option.

Press or to highlight the desired option and press to select.

✎ Touch Controls

Slide up or down to scroll and tap menu items or icons to select options or adjust settings (📖 16).

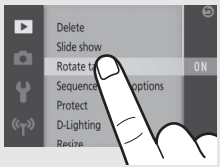

The **F** (Feature) Menu

To display the feature menu and adjust camera settings or access playback options, press **F** (feature) on the multi selector.

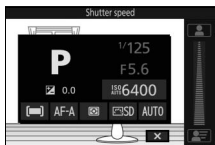

F menu (shooting mode)

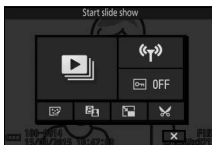

F menu (playback)

1 Select an item.

Use the multi selector to highlight an item and press **OK** to display options (to exit the **F** menu, press the shutter-release button halfway as described on page 30 or highlight **X** and press **OK**).

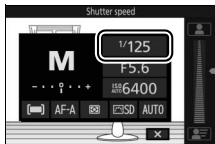

2 Select an option.

Highlight the desired option or value and press **OK** to select.

The **F** Menu

The **F** menu is context-sensitive: its contents vary with camera settings or the type of image displayed; options that are currently unavailable are shown in gray. The **F** menu is not available in auto or sports mode.

Items in the **F** menu can also be selected by tapping the monitor.

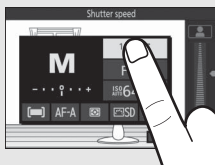

Tilting the Monitor

The monitor can be angled and rotated as shown below.

Normal use: The monitor is normally used in storage position.

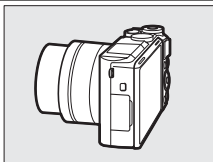

Low-angle shots: Tilt the monitor up to frame shots with the camera close to the ground. Once in the low-angle position, the monitor can be further lowered.

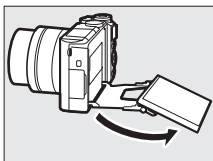
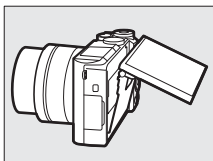
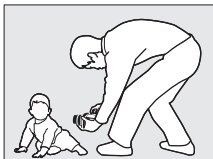
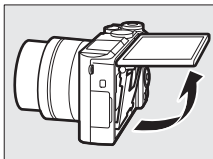

High-angle shots: Tilt the monitor down to frame shots while holding the camera over your head.

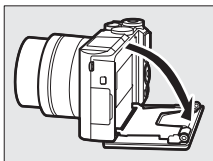

Self-portraits (83): Reverse the monitor to select self-portrait mode.

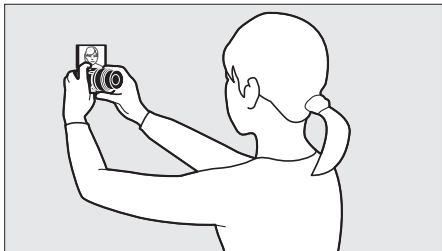
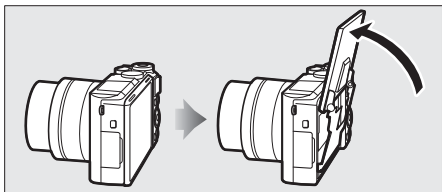

✓ Using the Monitor

Rotate the monitor gently within the limits of the hinges. *Do not use force.* Failure to observe these precautions could damage the camera or monitor. If the camera is mounted on a tripod, care should be taken to ensure that the monitor does not contact the tripod.

Do not touch the area to the rear of the monitor. Failure to observe this precaution could cause product malfunction.



Be particularly careful not to touch these areas.

Using the Touch Screen

The touch-sensitive monitor supports the following operations:

Tap

Tap the monitor.



Flick

Flick a finger a short distance across the monitor.

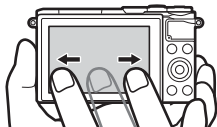

Slide

Slide a finger over the monitor.

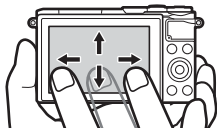

Stretch/Pinch

Place two fingers on the monitor and move them apart or pinch them together.

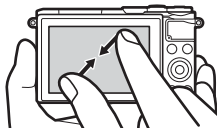
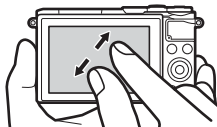

✓ The Touch Screen

The touch screen responds to static electricity and may not respond when covered with third-party protective films or when touched with fingernails or gloved hands. Do not use excessive force or touch the screen with sharp objects.

✓ Using the Touch Screen

The touch screen may not respond as expected if you attempt to operate it while leaving your palm or another finger resting on it in second location. It may not recognize other gestures if your touch is too soft, your fingers are moved too quickly or too short a distance or do not remain in contact with the screen, or if the movement of the two fingers in a pinch or stretch is not correctly coordinated.

✍ Enabling or Disabling Touch-screen Controls

Touch controls can be enabled or disabled using the **Touch-screen controls** option in the setup menu (☐ 103).

■ Taking Pictures

The touch screen can be used for the following shooting operations.

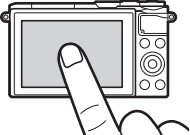
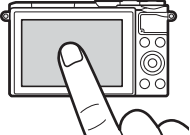
Take a picture (tap shooting)	 <p>In auto, creative, P, S, A, M, and self-portrait modes, you can focus and take a picture by tapping your subject in the display.</p>
Focus (tap shooting)	 <p>In advanced movie mode, you can focus by tapping your subject in the display.</p>

Adjust settings

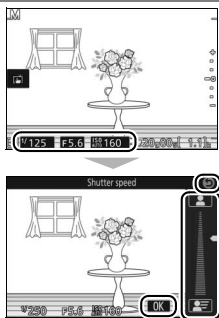

Tap highlighted icons to view settings and tap icons or sliders to change (the items available vary with camera settings). Tap **OK** to save changes and exit, or tap **⏪** to exit to the previous display without saving changes.

Tap Shooting Options

Tap shooting options can be adjusted by tapping the icon shown at right (📖 86).

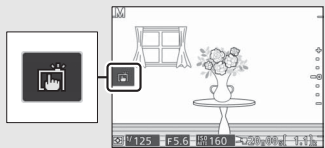

Viewing Pictures

The touch screen can be used for the following playback operations.

View other images

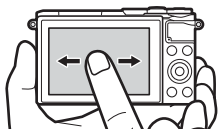





Flick left or right to view other images.

View movies or panoramas

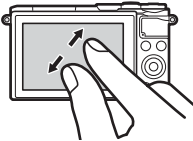

Tap the on-screen guide to start movie or panorama playback (movies are indicated by a **▶** icon). Tap the display to pause or resume.

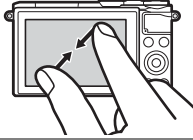
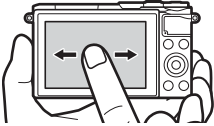
Guide

Zoom in		<p>Use stretch and pinch gestures to zoom in and out and slide to scroll. You can also double-tap a picture in full-frame playback to zoom in and double-tap again to exit zoom.</p>
 View thumbnails		<p>To “zoom out” to a thumbnail view, use a pinch gesture in full-frame playback. Use pinch and stretch to choose the number of images displayed from 4, 9, or 16 frames.</p>
View other months		<p>Flick left or right to view other months in the calendar display.</p>
Use on-screen guides		<p>Various operations can be performed by tapping on-screen guides.</p>

■ ■ Using the Menus

The touch screen can be used for the following menu operations.

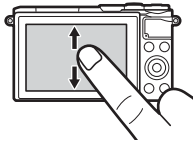
Scroll		<p>Slide up or down to scroll.</p>
---------------	---	------------------------------------

Choose a menu



Tap a menu icon to choose a menu.

**Select items/
adjust settings**

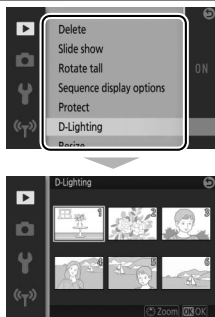

Tap menu items to display options and tap icons or sliders to change. Tap  to exit to the previous display without changing settings.





■ The **F Menu**

The touch screen can be used to adjust settings in the **F** menu.

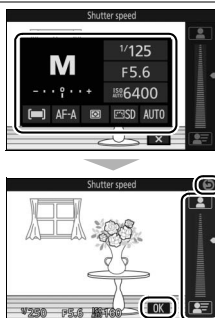
**Select items/
adjust settings**



Tap menu items to display options and tap icons or sliders to change. Tap  to save changes and exit, or tap  to exit to the previous display without changing settings.

First Steps

1 Attach the camera strap.

Attach the strap securely to the two camera eyelets.

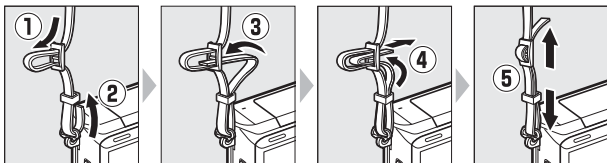

2 Charge the battery.

Insert the battery into the charger ① and plug the charger in ②. An exhausted battery fully charges in about two hours and 30 minutes. Unplug the charger and remove the battery when charging is complete.

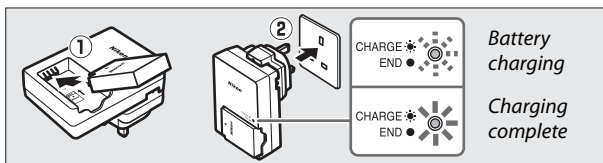

The Plug Adapter

Depending on the country or region of purchase, a plug adapter may be supplied with the charger. The shape of the adapter varies with the country or region of purchase. If a plug adapter is supplied, raise the wall plug and connect the plug adapter as shown at right, making sure the plug is fully inserted. Attempting to forcibly remove the plug adapter could damage the product.

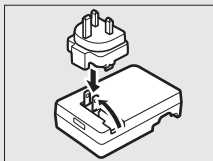

3 Insert the battery and a memory card.

The camera stores pictures on microSD, microSDHC, and microSDXC memory cards (available separately; [□ 109](#)). Before inserting the battery or memory cards, check that they are in the correct orientation. Using the battery to keep the orange battery latch pressed to one side, slide the battery in until it latches, and then slide in the memory card until it clicks into place. Do not attempt to insert the card at an angle; failure to observe this precaution could damage the product.

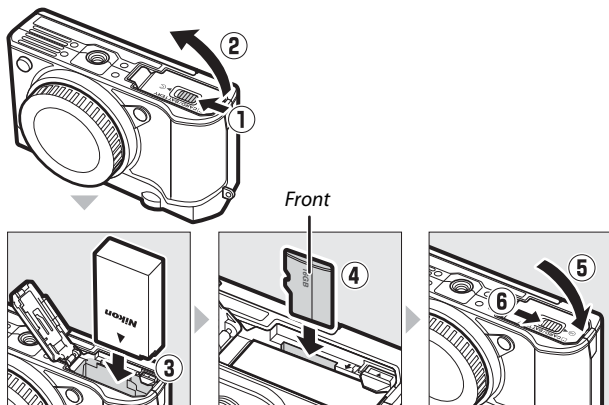

Formatting Memory Cards

If this is the first time the memory card will be used in the camera or if the card has been formatted in another device, select **Format memory card** in the setup menu and follow the on-screen instructions to format the card ([□ 102](#)). *Note that this permanently deletes any data the card may contain.* Be sure to copy any photographs and other data you wish to keep to a computer before proceeding ([□ 104](#)).

4 Attach a lens.

Be careful to prevent dust from entering the camera when the lens or body cap is removed. The lens generally used in this manual for illustrative purposes is a 1 NIKKOR VR 10–30mm f/3.5–5.6 PD-ZOOM. When using the 1 NIKKOR VR 10–30mm f/3.5–5.6 PD-ZOOM, be sure not to touch the lens cover; failure to observe this precaution could result in product malfunction.

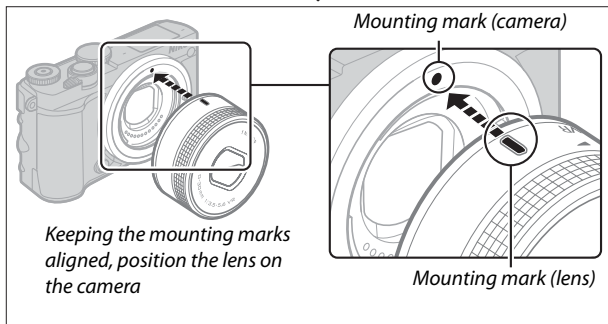
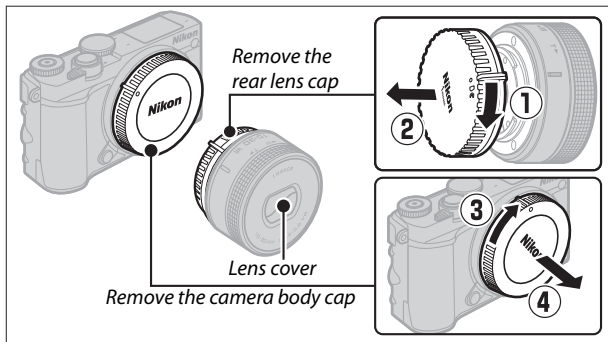

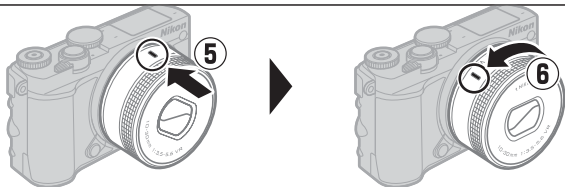

Rotate the lens as shown until it clicks into place.



Lenses with Retractable Lens Barrel Buttons

Lenses with retractable lens barrel buttons can not be used when retracted. To unlock and extend the lens, readying the camera for use, keep the retractable lens barrel button pressed (1) while rotating the zoom ring as shown (2). The lens can be retracted and the zoom ring locked by pressing the button and rotating the ring in the opposite direction. Retract the lens before removal, and be careful not to press the retractable lens barrel button while attaching or removing the lens.

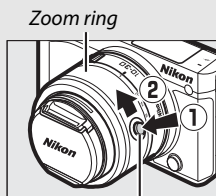

Retractable lens barrel button

The camera will turn on automatically when the retractable lens barrel lock is released; in addition, if the view through the lens is displayed or the monitor is off, the camera will turn off when the lens barrel is locked (in the case of 1 NIKKOR VR 10–30mm f/3.5–5.6 and 1 NIKKOR VR 30–110mm f/3.8–5.6 lenses, firmware version 1.10 or later is required if locking the lens barrel is to turn the camera off when the monitor is off; for information on updating lens firmware, visit the Nikon website for your area).

5 Turn the camera on.

Rotate the power switch to turn the camera on. The power lamp will briefly light green and the monitor will turn on. If the lens is equipped with a front lens cap, remove the cap before shooting. If a 1 NIKKOR VR 10–30mm f/3.5–5.6 PD-ZOOM lens is attached, the lens will automatically extend when the camera is turned on and retract when the camera is turned off.

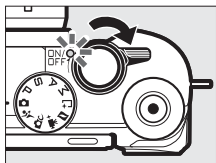

Turning the Camera Off

To turn the camera off, rotate the power switch again. The monitor will turn off.

Auto Power Off

If no operations are performed for about a minute, the display will turn off and the power lamp will start to flash. The camera can be reactivated by operating the shutter-release button. If no operations are performed for about three minutes after the display has turned off, the camera will turn off automatically.

6 Choose a language.

A language-selection dialog will be displayed the first time the camera is turned on. Use the multi selector and  button to choose a language.

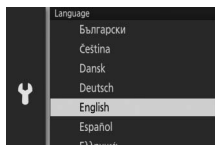

7 Set the clock.

Use the multi selector and **OK** button to set the time and date. *Note that the camera uses a 24-hour clock.*

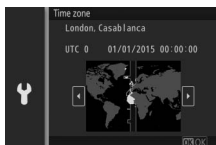

Press **←** or **→** to highlight time zone and press **OK**.

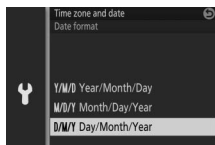

Press **↑** or **↓** to highlight date format and press **OK**.

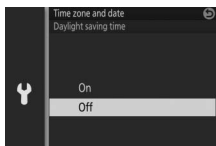

Press **↑** or **↓** to highlight daylight saving time option and press **OK**.

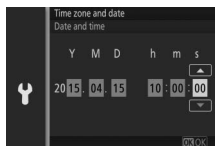

Press **←** or **→** to highlight items and press **↑** or **↓** to change. Press **OK** to exit to shooting display when setup is complete.

Note: Language and clock can be changed at any time using **Language** (📖 103) and **Time zone and date** (📖 103) options in setup menu.



8 Check the battery level and memory card capacity.

Check the battery level and number of exposures remaining in the monitor (📖 4).

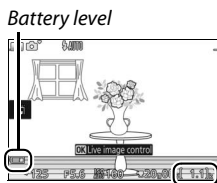

Exposures remaining



Taking and Viewing Photographs

This chapter describes how to take, view, and delete photographs in auto and creative mode.

Point-and-Shoot Photography (Auto Mode)

Follow the steps below to take photographs in auto mode, a “point-and-shoot” mode in which the camera automatically detects the subject type and adjusts settings according to the subject and situation.

1 Turn the camera on.

Rotate the power switch to turn the camera on.

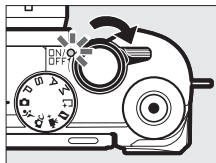

2 Select mode.

Rotate the mode dial to  (auto).

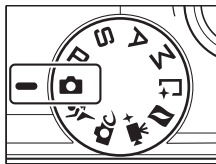

3 Ready the camera.

Hold the camera securely with both hands, being careful not to obstruct the lens, AF-assist illuminator, or microphone. Rotate the camera as shown at lower right when taking pictures in “tall” (portrait) orientation.

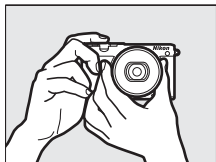

Shutter speeds slow when lighting is poor; use of the built-in flash (☞ 77) or a tripod is recommended.

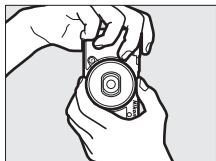

4 Frame the photograph.

Position your subject in the center of the frame. At default settings, the camera will automatically detect portrait subjects and position the focus point accordingly (☞ 31).

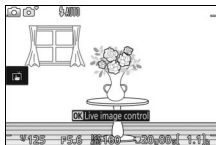

5 Focus.

Press the shutter-release button halfway to focus. If the subject is poorly lit, the flash may pop up (☞ 77) and the AF-assist illuminator (☞ 2) may light to assist the focus operation.

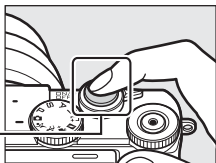

If the camera is able to focus, the selected focus area will be highlighted in green and a beep will sound (a beep may not sound if the subject is moving).

If the camera is unable to focus, the focus area will be displayed in red.

Focus area

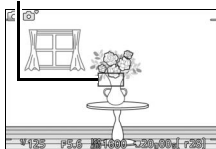

6 Shoot.

Smoothly press the shutter-release button the rest of the way down to release the shutter and record the photograph.

Pictures can also be taken using touch controls. Tap a subject anywhere in the frame to focus and release the shutter.

After the shutter is released, the memory card access lamp will light and the photograph will be displayed in the monitor for a few seconds (the photo will automatically clear from the display when the shutter-release button is pressed halfway). *Do not eject the memory card or remove the battery until the lamp has gone out and recording is complete.*

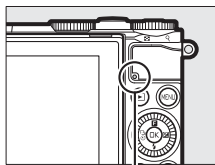
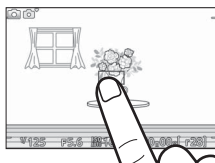
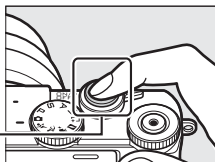

Memory card access lamp

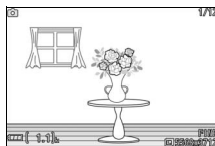

The Framing Grid

A framing grid can be displayed by selecting **On** for **Display > Grid display** in the setup menu (☰ 102).

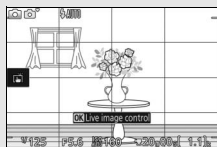

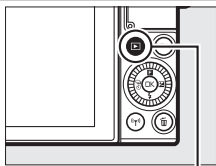

Viewing Photographs

Press  to display your most recent photograph full frame in the monitor (full-frame playback).

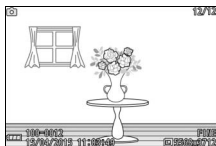

 button



Press  or  or rotate the multi selector to view additional pictures. You can also scroll through pictures by flicking left or right (book 15).

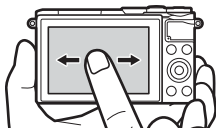

To zoom in on the center of the current image, rotate the command dial to the right. Rotate left to zoom out (you can also zoom in or out using touch controls: place two fingers on the monitor and spread them apart to zoom in or pinch them together to zoom out). To view multiple images, rotate the dial left when the picture is displayed full frame.

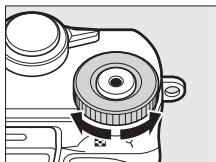

Command dial

To end playback and return to shooting mode, press the shutter-release button halfway.

Deleting Pictures

To delete the current picture, press . Note that once deleted, pictures can not be recovered.

1 Display the photograph.

Display the photograph you wish to delete as described on the preceding page.

2 Press .

A confirmation dialog will be displayed.

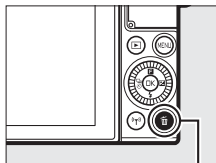

button



3 Delete the photograph.

Press again to delete the picture and return to playback, or press to exit without deleting the picture.

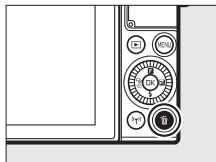

Deleting Multiple Pictures

The **Delete** option in the playback menu (100) can be used to delete all or selected pictures.

The Shutter-Release Button

The camera has a two-stage shutter-release button. The camera focuses when the shutter-release button is pressed halfway. To take the photograph, press the shutter-release button the rest of the way down.



Focus: Press halfway





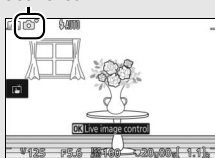

Shoot: Press the rest of the way down

Automatic Scene Selection

In auto mode, the camera automatically analyzes the subject and selects the appropriate scene. The selected scene is shown in the monitor.

Scene icon



	Portrait: Human portrait subjects.
	Landscape: Landscapes and cityscapes.
	Night portrait: Portrait subjects framed against dark backgrounds.
	Close-up: Subjects close to the camera.
	Night landscape: Poorly-lit landscapes and cityscapes.
	Auto: Subjects that do not fall into the categories listed above.

Using a Zoom Lens

Use the zoom ring to zoom in on the subject so that it fills a larger area of the frame, or zoom out to increase the area visible in the final photograph. During movie recording with the 1 NIKKOR VR 10–30mm f/3.5–5.6 PD-ZOOM, the zoom rate is unaffected by the speed with which the ring is rotated.

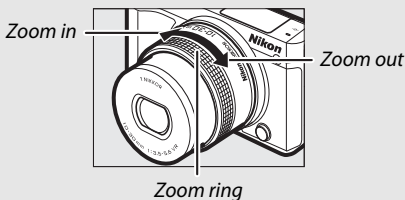

Face Priority

The camera detects and focuses on portrait subjects (face priority). A double yellow border will be displayed if a portrait subject is detected facing the camera (if multiple faces, up to a maximum of five, are detected, the camera will select the closest subject).

Press the shutter-release button halfway to focus on the subject in the double yellow border. The border will clear from the display if the camera can no longer detect the subject (because, for example, the subject has looked away).



Recording and Viewing Movies

Recording Movies

1 Turn the camera on.

Rotate the power switch to turn the camera on.

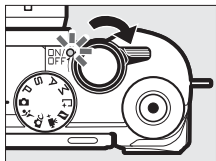

2 Choose a shooting mode.

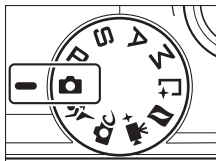

Rotate the mode dial to any of the positions shown at right.



3 Frame the opening shot.

Frame the opening shot with your subject in the center of the display.

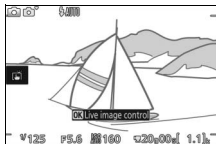

The Icon

A icon indicates that movies can not be recorded.

4 Start recording.

Press the movie-record button to begin recording. A recording indicator, the time elapsed, and the time available are displayed while recording is in progress.

Audio Recording

Be careful not to cover the microphone and note that the built-in microphone may record sounds made by the camera or lens. Except when recording time-lapse or slow-motion movies in advanced movie mode, the camera focuses continuously; to avoid recording focus noise, select **Single AF** for **Focus mode** in the movie menu (☞ 102).

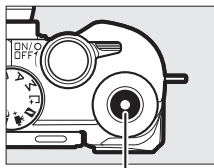

Movie-record button

*Recording indicator/
Time elapsed*



Time available

5 End recording.

Press the movie-record button again to end recording. Recording will end automatically when the maximum length is reached (☞ 40), the memory card is full, another mode is selected, the lens is removed, or the camera becomes hot (☞ xiii).

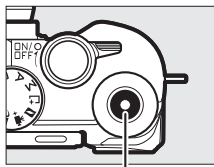

Movie-record button











Maximum Length

The camera can record movies up to 4 GB in size; note that depending on memory card write speed, shooting may end before this length is reached (☞ 109).



■ ■ Choosing a Shooting Mode

The features available in each mode are listed below.

 Auto mode (☞ 25)	Choose this mode to record HD movies while leaving the camera in charge of choosing settings. The camera automatically adjusts settings according to the subject and situation.
 Creative mode (☞ 41)	Record HD movies with the selected effect. Note, however, that the selected effect is not applied in the cases of  HDR ,  Soft ,  Easy panorama ,  Miniature effect ,  Toy camera effect , * Cross screen , and  Skin softening .
 Sports mode (☞ 53)	
P S P, S, A, and M modes A M (☞ 49)	Record HD movies in exposure mode P .
 Advanced movie mode (☞ 38)	Choose an exposure mode (☞ 101) and record HD movies at a selected shutter speed or aperture, or record movies in slow or fast motion or with other special effects.

Taking Photographs During Movie Recording

Press the shutter-release button all the way down to take a photograph without interrupting movie recording. Photographs taken during movie recording have an aspect ratio of 3 : 2.



▣ Taking Photographs During Movie Recording

Up to 20 photographs can be taken with each movie shot. Please note that photographs can not be taken with slow-motion, 4K, or time-lapse movies in advanced movie mode.



Viewing Movies

Movies are indicated by a  in full-frame playback ( 28). Press the  button or tap the  icon to start playback.

 icon/Length

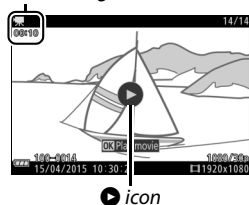

 icon



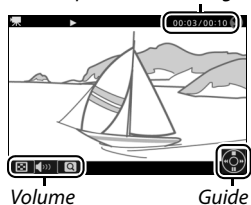







Current position/total length





Volume

Guide

The following operations can be performed:

To	Use	Description
Pause		Pause playback; the current position is shown at the top of the display. Playback can also be paused by tapping the monitor. 
Play		Resume playback when the movie is paused or during rewind/advance.
Advance/ rewind		Press  to rewind,  to advance. Speed increases with each press, from 2x to 4x to 8x to 16x. If playback is paused, the movie rewinds or advances one frame at a time; keep the button pressed for continuous rewind or advance.
Adjust volume		Rotate the command dial to adjust volume.
Return to full-frame playback	 	Press  or  to exit to full-frame playback.

Deleting Movies

To delete the current movie, press . A confirmation dialog will be displayed; press  again to delete the movie and return to playback, or press  to exit without deleting the movie. *Note that once deleted, movies can not be recovered.*

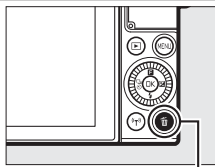

 button

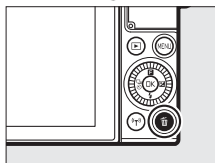

Recording Movies



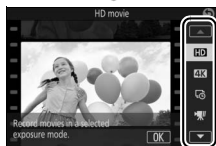
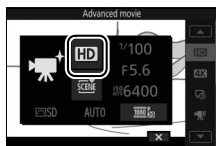

Flicker, banding, or distortion may be visible in the display and in the final movie under fluorescent, mercury vapor, or sodium lamps or with subjects that are in motion, particularly if the camera is panned horizontally or an objects moves horizontally at high speed through frame (flicker and banding can be reduced by choosing a **Flicker reduction** option that matches the frequency of the local AC power supply, but note that the slowest shutter speed available is $\frac{1}{100}$ s at **50 Hz**, $\frac{1}{60}$ s at **60 Hz**; flicker reduction is not available with slow-motion movies). Bright light sources may leave after-images when the camera is panned. Jagged edges, color fringing, moiré, and bright spots may also appear. When recording movies, avoid pointing the camera at the sun or other strong light sources. Failure to observe this precaution could result in damage to the camera's internal circuitry. The built-in flash will not fire during movie recording or when the camera is in advanced movie mode.

📹+ Advanced Movie Options

Advanced movie mode can be used not only to shoot HD movies, but also to record movies with a variety of effects. The following options can be accessed by pressing **F** and selecting **Advanced movie** in the **F** (feature) menu.

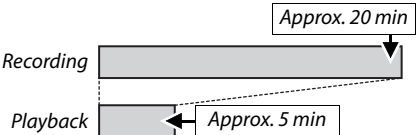

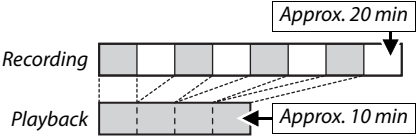
HD HD movie	Record HD movies in the exposure mode of your choice (📖 101).
4K 4K movie	Record movies at a frame size of 3840 × 2160 pixels and a frame rate of 15 fps.
📷 Time-lapse movie	<p>The camera automatically takes photographs at selected intervals and joins them together in a silent time-lapse movie.</p>
📹 Slow motion	<p>Record up to about three seconds of silent slow-motion footage. Slow-motion movies are recorded at 400 fps and play back at about 30 fps.</p>

 Fast motion	<p>Record silent fast-motion footage that plays back at about four times normal speed. Playback time is one quarter the recording time.</p> 
 Jump cut	<p>Record silent jump-cut movies. Recording pauses every other second for a drop-frame effect.</p> 
 4-second movie	<p>Record a 4-second movie clip.</p>

Adjusting Focus During Recording

To change focus during recording, tap the desired subject in the display. The camera will display the new focus area and adjust focus.

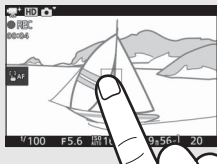

4K Movies

4K movies can be viewed on a computer and edited using ViewNX-i, the latest version of which is available for download from the website listed below. Note that a high-performance system is required; for information, see the website below.

<http://downloadcenter.nikonimglib.com/>

When the camera is connected to a 4K-movie compatible television using an HDMI cable, 4K movies will play back in Full HD (1920 × 1080 pixels, 30p). Even if the television is 4K-movie compatible, 4K movies can not be viewed by inserting the camera memory card in a television microSD card slot.



Recording Time

The following table lists the approximate maximum recording times for individual movies shot at the default frame rate in each shooting mode.

Auto, creative, P, S, A, M, sports modes	17 minutes
Advanced movie mode	
HD movie	17 minutes
4K movie	10 minutes
Time-lapse movie	25 minutes
Slow motion	3 seconds
Fast motion	20 minutes (📖 39)
Jump cut	20 minutes (📖 39)
4-second movie	4 seconds



Other Shooting Modes

The camera offers a choice of modes that can be used to match settings to the subject or situation, take photos using special effects, control shutter speed and aperture, help with hard-to-time shots, or combine photos with brief movie vignettes.

Choosing a Creative Mode

Choose creative mode to match settings to the subject or situation or take photos using special effects.

1 Select mode.

Rotate the mode dial to  (creative).

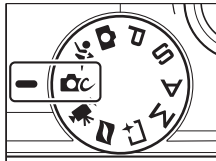

2 Choose an option.

Press **F** (feature) on the multi selector to display the **F** menu, then highlight **Creative** and press **OK**. Highlight an option suited to your subject and creative intent ( 42) and press **OK**.

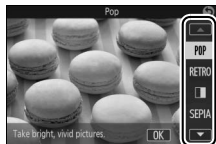
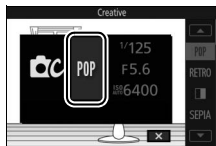

Choosing a Mode That Matches the Subject or Situation

Choose a creative mode according to the subject or situation:

Option	Description
Pop (POP)	Shoot bright, vivid pictures.
Retro (RETRO)	Choose for a faded, retro effect. Use the F (feature) menu (□ 10) to choose a hue from red and yellow.
High-contrast monochrome (□■)	Shoot in high-contrast black-and-white.
Nostalgic sepia (SEPIA)	Shoot in sepia for an antique look.
HDR (HDR)	Photograph high-contrast scenes (□ 44).
Soft (○)	Shoot photographs with a soft filter effect. Use the F menu to select the amount of softening and to choose how softening applies when a portrait subject is detected: <ul style="list-style-type: none">• Filter strength: Choose from H (high), N (normal), and L (low).• Portrait: If ON is selected and the camera detects portrait subjects (up to three), softening will be adjusted to make them stand out. If OFF is selected, softening will be applied equally to the portrait subject and the background.
Easy panorama (□)	Shoot panoramas for later viewing on the camera (□ 45).
Miniature effect (📷)	The top and bottom of each photo is blurred so that the subject appears to have been a diorama photographed at short range. Works best when shooting from a high vantage point.
Selective color (🖌️)	Take photos in which only a selected hue appears in color (□ 48).
Cross process (🌀)	Choose a base color to create photographs with different hues. Use the F menu to choose a base color from red, green, blue, and yellow.



Option	Description
Toy camera effect (📷)	Alter color saturation and reduce peripheral illumination for a toy camera effect. The following options are available in the F menu (📷 10): <ul style="list-style-type: none"> • Saturation: Choose from 📷 H (high), 📷 N (normal), and 📷 L (low). • Vignetting: Choose the amount of vignetting from 📷 H (high), 📷 N (normal), and 📷 L (low).
Cross screen (✳️)	Add starburst effects to light sources.
Fisheye (📷)	Create the effect of a fisheye lens. The following option is available in the F menu: <ul style="list-style-type: none"> • Filter strength: The level of the fisheye effect. Choose from 📷 H (high), 📷 N (normal), and 📷 L (low).
Skin softening (📷)	Soften the look of skin for up to three portrait subjects at a time. The amount of softening can be selected using the Filter strength option in the F menu; choose from 📷 (high), 📷 (normal), and 📷 (low).
Night landscape (📷)	Capture poorly-lit landscapes and cityscapes.
Night portrait (📷)	Choose for portraits taken against a poorly-lit backdrop.
Landscape (📷)	Choose for vibrant landscapes and cityscapes.
Close-up (📷)	Use for close-up shots of flowers, insects, and other small objects.
Portrait (📷)	Use for portraits with soft, natural-looking skin tones.



HDR

Details in highlights and shadows are preserved using HDR (high dynamic range). Each time the shutter-release button is fully pressed, the camera takes two shots in quick succession and combines them to preserve details in highlights and shadows in high-contrast scenes; the built-in flash does not fire. Some time may be required to process the pictures; the final photograph will be displayed when processing is complete.



Framing HDR Photographs

The edges of the image will be cropped out. The desired results may not be achieved if the camera or subject moves during shooting. Depending on the scene, shading may be uneven and shadows may appear around bright objects or halos around dark objects.

Easy Panorama

Follow the steps below to shoot panoramas. During shooting, the camera focuses using auto-area AF (📖 102); face detection (📖 31) is not available. Exposure compensation can be used, but the built-in flash will not fire.

1 Set focus and exposure.

Frame the start of the panorama and press the shutter-release button halfway. Guides will appear in the display.

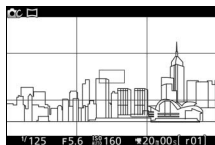

2 Start shooting.

Press the shutter-release button the rest of the way down and then lift your finger from the button. ⤴, ⤵, ⤶, and ⤷ icons will appear in the display to indicate the possible pan directions.

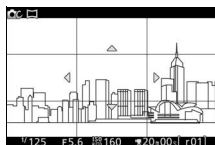



3 Pan the camera.

Slowly pan the camera up, down, left, or right as shown below. Shooting will start when the camera detects the pan direction and a progress indicator will appear in the display. Shooting ends automatically when the end of the panorama is reached.

Progress indicator



An example of how to pan the camera is shown below. Without changing your position, pan the camera in a steady curve either horizontally or vertically. Time the pan according to the option selected for **Image size** in the shooting menu: about 15 seconds are needed to complete the pan when  **Normal panorama** is selected, about 30 seconds when  **Wide panorama** is selected.

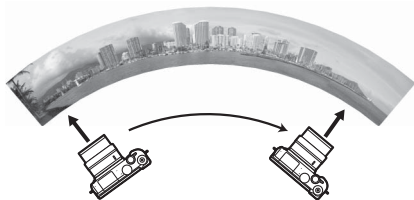



Panoramas

High-distortion wide-angle lenses may fail to produce the desired results. An error message will be displayed if the camera is panned too quickly or unsteadily. Note that because panoramas are composed of multiple images, the joins between images may be visible and the desired results may not be achieved with moving subjects or with neon lights or other subjects that exhibit rapid changes in color or brightness, subjects that are too close to the camera, poorly-lit subjects, and subjects such as the sky or sea that are a solid color or contain simple repeating patterns.







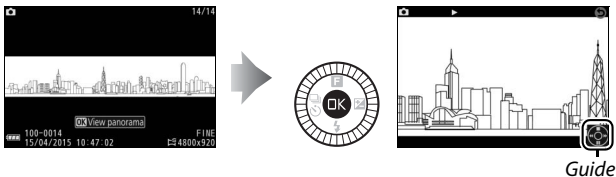



The completed panorama will be slightly smaller than the area visible in the display during shooting. No panorama will be recorded if shooting ends before the halfway point; if shooting ends after the halfway point but before the panorama is complete, the unrecorded portion will be shown in gray.

■ Viewing Panoramas

Panoramas can be viewed by pressing  when a panorama is displayed full frame ( 28). The start of the panorama will be displayed with the smallest dimension filling the display and the camera will then scroll through the picture in the original pan direction.



The following operations can be performed:

To	Use	Description
Pause		Pause playback. A navigation window will appear at the bottom of the display. 
Play		Resume playback when the panorama is paused or during rewind/advance.
Advance/ rewind		Press  to rewind,  to advance. If playback is paused, the panorama rewinds or advances a segment at a time; keep the button pressed for continuous rewind or advance.
Return to full-frame playback	 / 	Press  or  to exit to full-frame playback.



Selective Color

Take black-and-white pictures in which one hue appears in a color.

1 Choose Select color.

Press **F** to display the **F** (feature) menu, then highlight **Select color** and press **OK**.



2 Choose a color.

Use the multi selector to choose a color and press **OK**.

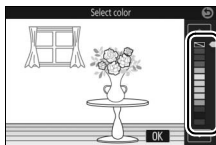

3 Take pictures.

Press the shutter-release button all the way down to take pictures. Only the selected hue will appear in color; all other hues will be recorded in shades of gray.

Taking Photos in P, S, A, and M Modes

P, S, A, and M modes offer varying degrees of control over shutter speed and aperture. Choose a mode and adjust settings according to your creative intent.



P Programmed Auto

In this mode, the camera automatically adjusts shutter speed and aperture for optimal exposure in most situations. This mode is recommended for snapshots and other situations in which you want to leave the camera in charge of shutter speed and aperture.



Choosing a Combination of Shutter Speed and Aperture

Although the shutter speed and aperture chosen by the camera will produce optimal results, you can also rotate the command dial to choose other combinations that will produce the same exposure (“flexible program”). * is displayed while flexible program is in effect.

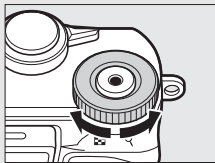

Command dial

ISO Sensitivity (P, S, A, and M Modes)

When an “auto” option is selected for **ISO sensitivity** (☐ 101), the camera will automatically adjust sensitivity within the selected range if optimal exposure can not be achieved at the selected shutter speed or aperture.

S Shutter-Priority Auto

In shutter-priority auto, you choose the shutter speed while the camera automatically selects the aperture that will produce the optimal exposure. Use slow shutter speeds to suggest motion by blurring moving subjects, fast shutter speeds to “freeze” motion.



Fast shutter speed ($1/1600$ s)

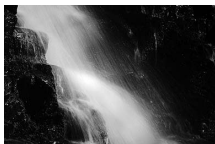

Slow shutter speed (1 s)

■ Choosing a Shutter Speed

Rotate the command dial to choose from shutter speeds between 30 s and $1/16,000$ s. Rotate the dial to the right for faster shutter speeds, to the left for slower shutter speeds.

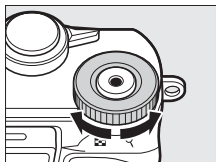

Command dial

✎ Continuous Shooting

The selected shutter speed may change when a frame rate of 10 fps or faster is selected in continuous shooting mode (□ 73).

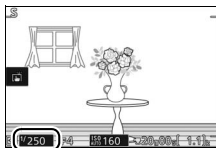

A Aperture-Priority Auto

In aperture-priority auto, you choose the aperture while the camera automatically selects the shutter speed that will produce the optimal exposure. Large apertures (low f-numbers) reduce depth of field, blurring objects behind and in front of the main subject. Small apertures (high f-numbers) increase depth of field, bringing out details in the background and foreground. Short field depths are generally used in portraits to blur background details, long field depths in landscape photographs to bring the foreground and background into focus.



Large aperture (f/5.6)



Small aperture (f/16)



■ ■ Choosing an Aperture

Rotate the multi selector counterclockwise for larger apertures (lower f-numbers), clockwise for smaller apertures (higher f-numbers). The minimum and maximum values depend on the lens currently in use.

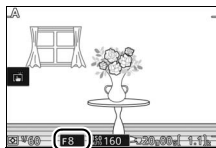

M Manual

In manual mode, you control both shutter speed and aperture.

■ Choosing Shutter Speed and Aperture

Adjust shutter speed and aperture with reference to the exposure indicator (☞ 52). Rotate the command dial to adjust shutter speed and the multi selector to adjust aperture: rotate the control to the right for faster shutter speeds or smaller apertures (higher f-numbers), to the left for slower shutter speeds and larger apertures (lower f-numbers). Shutter speeds can be set to values as fast as $\frac{1}{16,000}$ s or as slow as 30 s, or to “Bulb” to hold the shutter open indefinitely for a long time-exposure. Aperture can be set to values between the minimum and maximum for the lens.

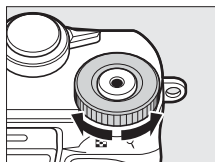

Command dial



✎ Continuous Shooting

The selected shutter speed may change when a frame rate of 10 fps or faster is selected in continuous shooting mode (☞ 73).

✎ The Exposure Indicator

When shutter speeds other than “Bulb” are selected, the exposure indicator shows whether the photograph would be under- or over-exposed at current settings.

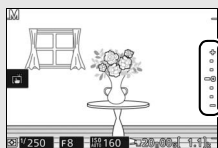

Optimal exposure	Underexposed by $\frac{1}{3}$ EV	Overexposed by over 2 EV
+	+	+
.	.	.
.	.	.
-0	=0	.
.	.	.
.	.	.
-	-	-

🏆 Photographing Subjects in Motion (Sports Mode)

Choose 🏆 (sports) mode for sporting events and other scenes with fast-moving subjects. The camera takes pictures continuously while the shutter-release button is pressed (📖 73).

1 Select sports mode.

Rotate the mode dial to 🏆.

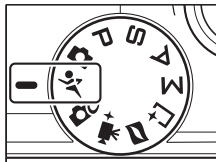

2 Display release mode options.

Press 🏆 (🏆) to display release mode options.

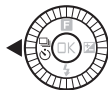

3 Select a frame rate.

Highlight the desired frame rate and press OK. Frame rate is expressed in terms of the number of frames recorded per second (fps); choose from frame rates of approximately 5, 10, 20, 30, and 60 fps (📖, 📖10, 📖20, 📖30, and 📖60, respectively). Except when 📖 is selected, the maximum number of shots that can be recorded in a single burst is 20.

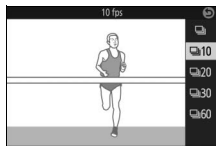

4 Compose the shot and start shooting.

The camera takes pictures while the shutter-release button is held all the way down.



Sports Mode

The camera uses single-point, continuous-servo autofocus. The flash, AF-assist illuminator, face priority (☞ 102), and image review (☞ 102) turn off automatically.

Burst Photography

While photographs are being recorded to the memory card, the memory card access lamp will light (☞ 27). Depending on shooting conditions and memory card write speed, recording may continue for some time after shooting ends. If the battery is exhausted before all photographs are recorded, the shutter-release will be disabled and the remaining images transferred to the memory card.

Viewing Photographs

Each burst plays back as a group. This can be changed using the **Sequence display options** item in the playback menu (☞ 100).



2 Choose Active Selection.

Press **F** (feature) to display the **F** menu. Highlight **Best moment capture** and press **OK**, then highlight **Active Selection** and press **OK**.

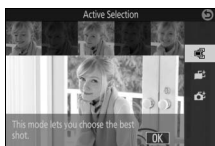
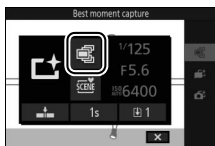

3 Frame the photograph.

Compose the photograph with your subject in the center of the frame.



4 Begin buffering photographs.

Press the shutter-release button halfway to focus (26). A  icon will be displayed as the camera begins recording images to the memory buffer.

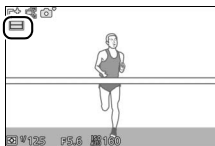

5 Shoot.

Smoothly press the shutter-release button the rest of the way down. The 20 frames recorded to the buffer in the moments before and after the shutter-release button was pressed all the way down will be copied to temporary storage, and an indicator will appear at the top of the display.

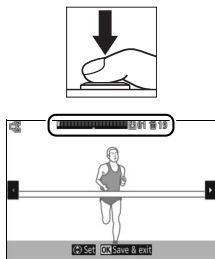

6 Select up to 20 frames.

Press or to scroll through the frames and press or to select or deselect (the number of frames selected by default varies with the option selected for **Frames saved (default)** in the **F** (feature) menu). Selected images are shown by dots in the indicator.

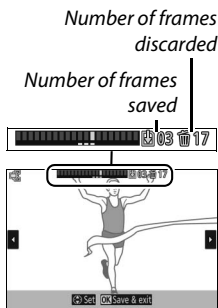

7 Save the selected frames.

Press to save the selected frames to the memory card. The memory card access lamp will light while recording is in progress; note that depending on shooting conditions and memory card write speed, some time may be required to save the selected frames. Once recorded, the frames will be treated as a single group during playback.

Best Moment Capture Mode

Movies can not be recorded, and pressing the movie-record button has no effect. The flash can not be used.

Active Selection

At default settings, the frame recorded at the moment the shutter-release button was pressed all the way down is automatically marked with a  icon in Step 6.



Choosing Your Moment (Slow View)

When slow view is selected in  (best moment capture) mode, the camera captures a short sequence of still images and plays them back in slow motion so that you can choose the precise moment for a photograph.

1 Select mode.

Rotate the mode dial to  (best moment capture).

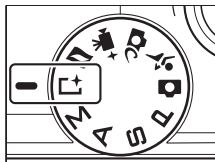

2 Select Slow view.

Press **F** (feature) to display the **F** menu. Highlight **Best moment capture** and press **OK**, then highlight **Slow view** and press **OK**.

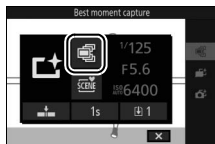

3 Frame the photograph.

Compose the photograph with your subject in the center of the frame.

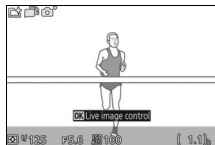

4 Press the shutter-release button halfway.

After focusing, the camera will record 20 frames to a temporary memory buffer. It will then slowly play them back in a continuous loop while the shutter-release button is kept pressed halfway. A  icon is displayed in the monitor.



Progress indicator



When the desired frame is displayed, press the shutter-release button the rest of the way down to record the current frame and discard the remaining images. The selected frame will be displayed for a few seconds when recording is complete. To delete the buffer contents and exit without recording a photograph, release the button without pressing it the rest of the way down.



Letting the Camera Choose the Moment (Smart Photo Selector)

The Smart Photo Selector helps you capture a fleeting expression on the face of a portrait subject or other hard-to-time shots such as group photos in party scenes. Each time the shutter is released, the camera automatically selects the best shot and four best shot candidates based on composition and motion.

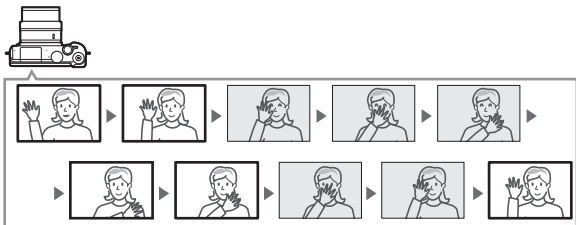

1 Select $\square+$ mode.

Rotate the mode dial to $\square+$ (best moment capture).

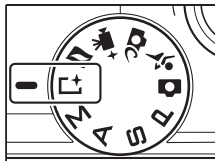

2 Choose Smart Photo Selector.

Press **F** (feature) to display the **F** menu. Highlight **Best moment capture** and press **OK**, then highlight **Smart Photo Selector** and press **OK**.

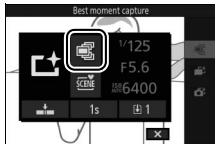

3 Frame the photograph.

Compose the photograph with your subject in the center of the frame.



4 Begin buffering photographs.

Press the shutter-release button half-way to focus (26). A  icon will be displayed as the camera begins recording images to the memory buffer. The camera continuously adjusts focus to account for changes in the distance to the subject while the shutter-release button is pressed halfway.



5 Shoot.



Smoothly press the shutter-release button the rest of the way down. The camera will compare shots recorded to the buffer both before and after the shutter-release button was pressed all the way down, and select the best shot and four best shot candidates to the memory card; during playback, these frames will be treated as a single group. The best shot is displayed in the monitor when recording is complete; note that some time may be required.



Smart Photo Selector

The camera automatically chooses a scene mode appropriate to the subject.

■ Viewing Photos Taken with the Smart Photo Selector



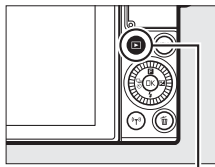

Press  and use the multi selector to display photographs taken with the Smart Photo Selector (📖 28; pictures taken with the Smart Photo Selector are indicated by a  icon). Of the photographs recorded by the Smart Photo Selector, only the best shot will be displayed (when you press  to view the next picture, the camera will skip over the best shot candidates, with the result that the next picture displayed will not have a file number that immediately follows that of the current picture). To end playback and return to shooting mode, press the shutter-release button halfway.



 button





Choosing the Best Shot

When a photograph taken with the Smart Photo Selector is displayed, you can choose the best shot by pressing . Press  or  to view the other pictures in the sequence and press  to select the current picture as the best shot. To return to normal playback, press .



■ Deleting Pictures

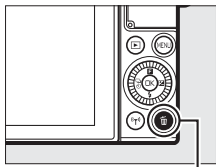

Pressing  when a picture taken with the Smart Photo Selector is selected displays a confirmation dialog; press  again to delete the best shot and the best shot candidates, or press  to exit without deleting the pictures. *Note that once deleted, pictures can not be recovered.*

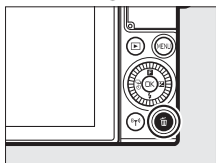

 button



Deleting Individual Photographs

Pressing the  button in the best shot selection dialog displays the following options; highlight an option using the multi selector and press  to select.

- **This image:** Delete the current photo (note that the picture currently selected as the best shot can not be deleted).
- **All except best shot:** Delete the best shot candidates, but not picture currently selected as the best shot.

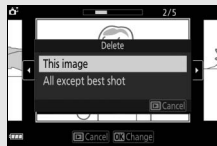

A confirmation dialog will be displayed; to delete the selected image or images, highlight **Yes** and press .

☑ Combining Photos with Brief Movie Vignettes (Motion Snapshot Mode)

Record brief movie vignettes with your photographs. Each time the shutter is released, the camera records a still image and about 1.6 s of movie footage. When the resulting “Motion Snapshot” is viewed on the camera, the movie will play back in slow motion over approximately 4 s, followed by the still image.

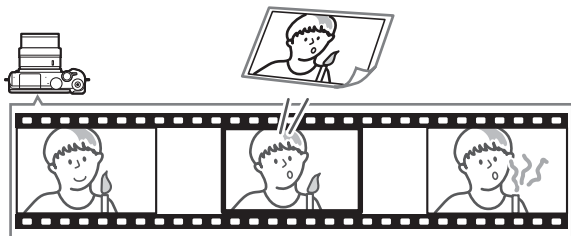

1 Select **☑** mode.

Rotate the mode dial to **☑** (Motion Snapshot).

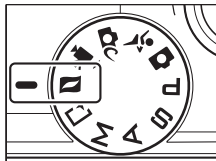

2 Frame the picture.

Compose the photograph with your subject in the center of the frame.



3 Begin buffering.

Press the shutter-release button half-way to focus (📖 26). A  icon will be displayed as the camera begins recording footage to the memory buffer.



4 Shoot.

Smoothly press the shutter-release button the rest of the way down. The camera will record a photograph, together with about 1.6 s of movie footage beginning before and ending after the time the shutter-release button was pressed all the way down. Note that some time may be required. When recording is complete, the photograph will be displayed for a few seconds.



Motion Snapshot Mode

Movies can not be recorded using the movie-record button and the flash can not be used.

Movie Before/After

Use the **Movie before/after** option in the **F** (feature) menu to choose whether the movie portions of Motion Snapshots end when the shutter-release button is pressed all the way or about 0.6 s after (📖 65). If **1.6 s : 0 s** is selected, the photograph used for the Motion Snapshot will feature the last frame of the movie.

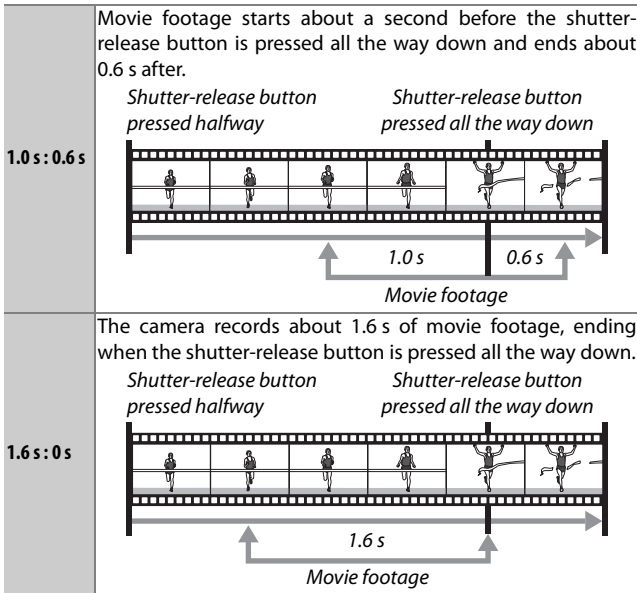

■ File Format

The **File format** option in the **F** menu can be used to choose the file format for Motion Snapshots.





NMS files	Motion Snapshots are recorded as a MOV file about 4 s long and a JPEG image. Motion Snapshots can only be viewed on the camera or using ViewNX-i (□ 104).
MOV file	Motion Snapshots are recorded as a MOV file about 10 s long that can be viewed in a variety of computer applications. The Motion Snapshot is not displayed automatically when shooting ends (□ 66, 102); for information on viewing Motion Snapshot movies, see page 36.

■ Audio

To record about four seconds of sound with Motion Snapshots beginning at the start of movie recording, use the multi selector and **OK** button to select **Ambient** for **Audio** in the **F** (feature) menu. Motion Snapshots can also be recorded with background music (**Background music**) or no sound (**None**).



Viewing Motion Snapshots

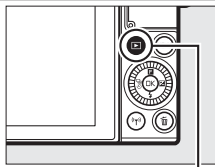

Press  and use the multi selector to display a Motion Snapshot (📖 28; Motion Snapshots are indicated by a  icon). Pressing the  button or tapping the  icon when a Motion Snapshot is displayed plays back the movie portion in slow motion over a period of about 4 s, followed by the photo; playback is accompanied by the audio track selected using the **Audio** option (📖 68). To end playback and return to shooting mode, press the shutter-release button halfway.



 button



Deleting Motion Snapshots

To delete the current Motion Snapshot, press . A confirmation dialog will be displayed; press  again to delete the photo and movie and return to playback, or press  to exit without deleting the file. *Note that once deleted, Motion Snapshots can not be recovered.*

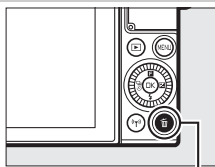

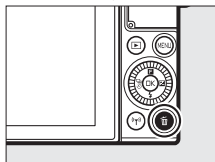
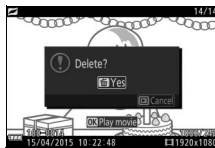

 button



More on Photography



This section describes the other features you can use when taking pictures.

Live Image Control

Live image control lets you preview how changes to each control will affect the final photography. Live image controls are available in the modes shown at right (in modes other than auto, live image controls are available only when  **Scene auto selector** is selected for exposure mode,  101). In advanced movie mode, live image controls apply to HD, fast-motion, jump-cut, and 4-second movies. In best moment capture mode, live image controls apply to Active Selection and slow view, but the  **Active D-Lighting** control is not available.



1 Choose a live image control.

Press  in the shooting display, then highlight an option and press  to view the selected control. For more information, see page 71.



2 Choose a setting.

Rotate the multi selector to adjust the control, using the preview in the monitor as your guide. Press  when the control is adjusted to your satisfaction. For information on using the creative palette, see page 72.



☞ Active D-Lighting: Preserve details in highlights and shadows for natural contrast.



Active D-Lighting: High Active D-Lighting: Low

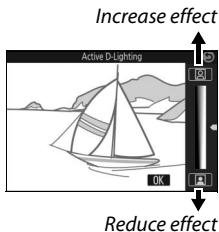

🏠 Background softening: Soften background details to make your subject stand out, or bring both background and foreground into focus.



Background sharp Background softened

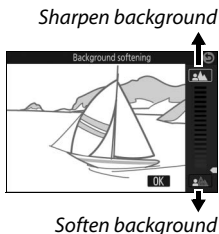

👤 Motion control (auto mode only): Suggest motion by blurring moving objects, or “freeze” motion to capture moving objects clearly.

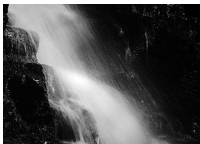

Freeze motion Blur motion

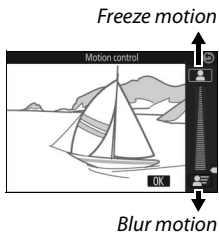

Brightness control: Make pictures brighter or darker.



Brighter



Darker

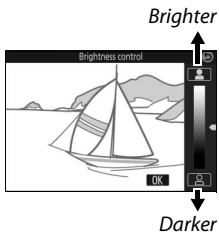

Creative palette: To choose a creative effect, rotate the multi selector or use a finger to rotate the creative palette in the monitor. The selected effect is visible in the monitor and changes gradually as the palette is rotated (to reset the palette, tap **Reset** while the creative palette cursor is displayed).

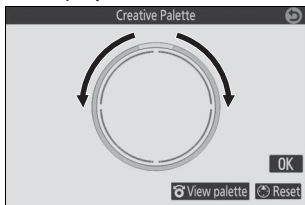
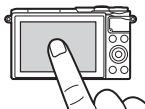

Photographs and movies will be recorded with the selected effect, but note that tap shooting options are not available when the creative palette is displayed (86).

Live Image Control

Continuous shooting is not available (73) and the built-in flash can not be used when live image control is in effect.

Continuous Mode



Shoot a continuous series (burst) of photographs.

1 Display release mode options.

Press  to display release mode options.







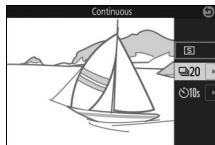

2 Select .

Highlight  (continuous) and press  to display frame rate options.



3 Select a frame rate.

Highlight the desired frame rate and press . Frame rate is expressed in terms of the number of frames recorded per second (fps); choose from frame rates of approximately 5, 10, 20, 30, and 60 fps (, , , , and , respectively). Except when  is selected, the maximum number of shots that can be recorded in a single burst is 20.

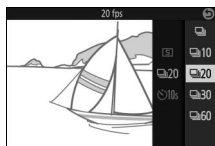

4 Frame your subject and shoot.

Press the shutter-release button all the way down to shoot the burst.



Continuous Mode

Only one picture will be taken if the flash fires when  is selected; at settings of 10, 20, 30, and 60 fps, the built-in flash will not fire.

While photographs are being recorded to the memory card, the memory card access lamp will light. Depending on shooting conditions and memory card write speed, recording may take some time. If the battery is exhausted before all photographs are recorded, the shutter release will be disabled and the remaining images transferred to the memory card.

Continuous shooting is not available with live image controls ( 70) or in self-portrait, creative, best moment capture, advanced movie, or Motion Snapshot mode.

Viewing Pictures Taken in Continuous Mode

Each burst plays back as a group. This can be changed using the **Sequence display options** item in the playback menu ( 100).

Single Frame

To take only one picture each time the shutter-release button is pressed all the way down, select  (single frame) for release mode. Single frame is not available in sports mode.



Self-Timer Modes

The self-timer is used to delay shutter release until 10 or 2 seconds after the shutter-release button is pressed all the way down.

1 Display release mode options.

Press to display release mode options.



2 Select .

Highlight (self-timer) and press to display self-timer options.

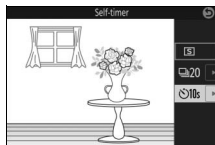

3 Select the desired self-timer option.

Use the multi selector to highlight or and press .

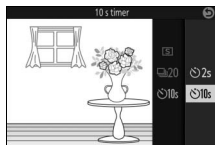

4 Mount the camera on a tripod.

Mount the camera on a tripod or place the camera on a stable, level surface.



5 Frame the photograph and shoot.

Press the shutter-release button half-way to focus, and then press the button the rest of the way down. The self-timer lamp will start to flash and a beep will begin to sound. Two seconds before the photo is taken, the lamp will stop flashing and the beeping will become more rapid.

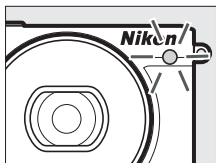

Note that the timer may not start or a photograph may not be taken if the camera is unable to focus or in other situations in which the shutter can not be released. Turning the camera off cancels the self-timer.



Movie Mode

To record movies using the self-timer, select advanced movie mode and use the movie-record button to start the timer. Movie recording ends when the movie-record button is pressed a second time.



Raising the Flash

In **P**, **S**, **A**, or **M** mode, press the flash pop-up button to raise the flash before shooting. Shooting will be interrupted if the flash is raised while the timer is counting down.



The Built-in Flash

Use the built-in flash for additional lighting when the subject is poorly lit or to “fill-in” (illuminate) back-lit subjects. The built-in flash is available in the following shooting modes, but note that some camera settings automatically disable the built-in flash:

Auto Pop-up Modes

In  (auto) mode and when an option other than HDR (HDR), easy panorama (📷), night landscape (🌃), or landscape (🏞️) is selected in  (creative) mode, the flash will pop-up automatically and fire when required.

1 Choose a flash mode.

Press  (⚡) on the multi selector to display a list of flash modes, then use the multi selector to highlight the desired mode and press  to select.

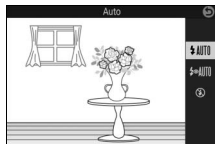

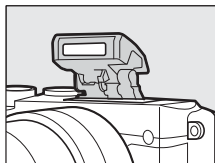

2 Take pictures.

Press the shutter-release button half-way to focus and the rest of the way down to shoot. The flash will pop up and fire when required.



■ Flash Modes

The following flash modes are available:

-  AUTO (auto flash): When lighting is poor or the subject is backlit, the flash pops up automatically when the shutter-release button is pressed halfway and fires as required.
-  AUTO (auto with red-eye reduction): Use for portraits. The flash pops up and fires as required, but before it fires, the red-eye reduction lamp lights to help reduce “red-eye.”
-  (off): The flash does not fire.



Manual Pop-up Modes

In **P**, **S**, **A**, **M**, and self-portrait modes, the flash must be raised manually. The flash will not fire if it is not raised.

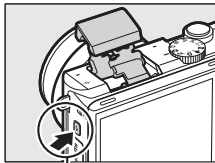

1 Raise the flash.

Press the flash pop-up button to raise the flash.



Flash pop-up button

2 Choose a flash mode.

Press  () on the multi selector to display a list of flash modes, then use the multi selector to highlight the desired mode and press  to select.

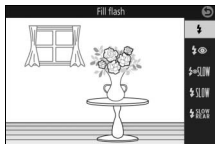





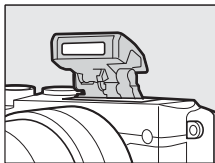

3 Take pictures.

The flash will fire with every shot. To disable the flash, press it gently downward until it latches.



■ Flash Modes

The following flash modes are available:

-  (fill flash): The flash fires with every shot.
-  (red-eye reduction): Use for portraits. The flash fires with every shot, but before it fires, the red-eye reduction lamp lights to help reduce “red-eye.”
-  SLOW (red-eye reduction with slow sync): As for “red-eye reduction”, above, except that shutter speed slows automatically to capture background lighting at night or under low light. Use when you want to include background lighting in portraits. Available only in modes **P** and **A**.
-  SLOW (fill flash + slow sync): As for “fill flash”, above, except that shutter speed slows automatically to capture background lighting at night or under low light. Use when you want to capture both subject and background. Available only in modes **P** and **A**.
-  SLOW REAR (rear curtain + slow sync): As for “rear-curtain sync”, below, except that shutter speed slows automatically to capture background lighting at night or under low light. Use when you want to capture both subject and background. Available only in modes **P** and **A**.
-  REAR (rear-curtain sync): The flash fires just before the shutter closes, creating a stream of light behind moving light sources as shown below at right. Available only in modes **S** and **M**.



Front-curtain sync



Rear-curtain sync

✓ Raising the Flash

When using the flash, be sure it is fully raised as shown at right. Do not touch the flash during shooting.

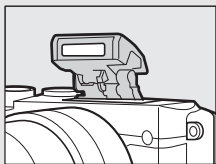

✎ Lowering the Built-in Flash

To save power when the flash is not in use, press it gently downward until the latch clicks into place. *Do not use force.* Failure to observe this precaution could result in product malfunction.

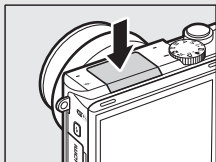

✎ The Flash-Ready Indicator

The flash-ready indicator (⚡) lights to show that the flash is fully charged when the shutter-release button is pressed halfway.



Using the Built-in Flash

If the flash is fired multiple times in quick succession, the flash and shutter may be temporarily disabled to protect the flash. Shooting can be resumed after a brief pause.

Objects close to the camera may be overexposed in photographs taken with the flash at high ISO sensitivities.

To avoid vignetting, remove lens hoods and shoot at ranges of at least 0.6 m (2 ft). Some lenses may cause vignetting at greater distances or obstruct the red-eye reduction lamp, interfering with red-eye reduction. The following illustrations show the effect of vignetting caused by shadows cast by the lens when the built-in flash is used.

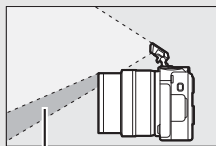

Shadow



Vignetting

Aperture, Sensitivity, and Flash Range

Flash range varies with sensitivity (ISO equivalency) and aperture.

Self-Portraits

To frame self-portraits in the monitor, reverse it as shown and follow the steps below.

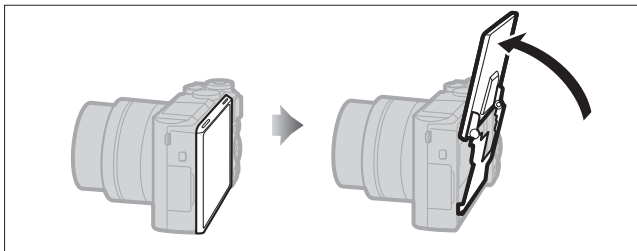

1 Reverse the monitor.

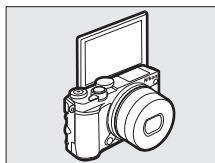

The camera will select self-portrait mode.

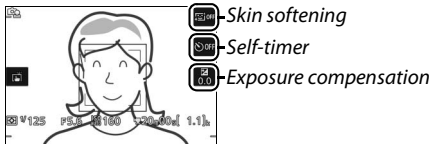

2 Adjust settings.

The following settings can be adjusted using touch controls:



 Skin softening	Tap to enable or disable skin softening. Enabling skin softening softens the look of skin for portrait subjects detected by the camera (up to a maximum of three), but note that the effect can not be previewed in the monitor.
 Self-timer	Tap to cycle through self-timer settings as follows: 2 s timer, 10 s timer, and self-timer off.
 Exposure compensation	Tap the exposure indicator to adjust exposure compensation and tap OK to exit when adjustments are complete.

3 Shoot.

Tap the monitor to focus on the selected subject and shoot, or press the shutter-release button halfway to focus and all the way down to take photographs. Use the movie-record button to shoot movies. Movies are recorded at 1080/30p.

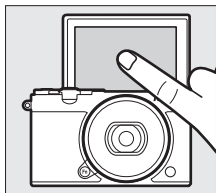

4 Exit self-portrait mode.

Moving the monitor out of the self-portrait position ends self-portrait mode.

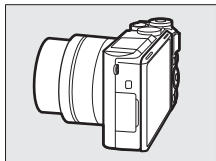

Self-Portrait Mode

Touch-screen controls are always available in self-portrait mode regardless of the option selected for **Touch-screen controls** in the setup menu (📖 103). All other controls except the power switch and the shutter-release, movie-record, and flash pop-up buttons are disabled; use the flash pop-up button to raise the flash as required. The flash fires in  **AUTO** (auto + red-eye reduction) mode. Photographs taken in self-portrait mode with **NEF (RAW)** or **NEF (RAW) + JPEG fine** selected for image quality will be recorded as fine-quality JPEG images.

If **Off** is selected for **Self-portrait mode** in the setup menu (📖 103), the camera will not enter self-portrait mode when the monitor is reversed, and pictures will instead be taken in the mode selected with the mode dial.



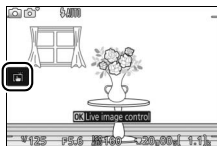

Tap Shooting Options

Tap the icon shown at right to choose the operation performed by tapping the monitor in shooting mode. The options available vary with the shooting and focus mode.





Auto, **Creative**, and **Self-Portrait Modes**

Choose from the following options.

	When you tap a subject in the display, the camera will focus and take a picture.
	Tap the monitor to position the focus area when Night landscape , Landscape , or Close-up is selected in creative mode (□ 41). To focus, press the shutter-release button halfway.
	Tapping the display during shooting has no effect.

Sports Mode





	Tap the monitor to position the focus area. To focus, press the shutter-release button halfway.
	Tapping the display during shooting has no effect.

P, S, A, and M Modes

The operation performed by tapping the display depends on whether the camera is in autofocus or manual focus mode.



Autofocus Modes

The following options are available in autofocus modes (AF-A, AF-S, and AF-C).

	When you tap a subject in the display, the camera will focus and take a picture.
	Tap the display to position the focus area when single-point AF is selected for AF-area mode (□ 102). To focus, press the shutter-release button halfway.
	Tap a subject to start tracking when subject tracking is selected for AF-area mode (□ 102).
	Tapping the display during shooting has no effect.

Manual Focus Mode

The following options are available in manual focus mode.

	When you tap the display, the camera will take a picture without first adjusting focus.
	Tap a subject to display it at a higher magnification in the monitor.
	Tapping the display during shooting has no effect.





Advanced Movie Mode

The operation performed by tapping the display depends on whether the camera is in autofocus or manual focus mode.



Autofocus Modes

The following options are available in autofocus modes (AF-F and AF-S).

	To focus when auto-area AF or single-point AF is selected for AF-area mode (□ 102), tap your subject in the display.
	Tap a subject to start tracking when subject tracking is selected for AF-area mode (□ 102).
	Tapping the display during shooting has no effect.

Manual Focus Mode

The following options are available in manual focus mode.

	Tap a subject to display it at a higher magnification in the monitor.
	Tapping the display during shooting has no effect.

Unsupported Modes

Tap shooting options are not available in best moment capture and Motion Snapshot modes or when **4K movie** is selected in advanced movie mode.

Taking Pictures Using Tap Shooting Options

Avoid tapping too hard. The camera may move when the shutter is released, blurring photographs.

The shutter-release button can be used to focus and take pictures even when the  icon is displayed to show that tap shooting options are active. Use the shutter-release button to take photographs in continuous shooting mode (□ 73) and during movie recording. Tap shooting options can be used only to take pictures one at a time in continuous shooting mode and can not be used to take photographs during movie recording. In self-timer mode (□ 75), tapping the monitor locks focus and starts the timer; the photograph will be taken after ten or two seconds.

What Wi-Fi Can Do for You

The camera can connect via Wi-Fi wireless networks to a smart device (smartphone or tablet) running Nikon's dedicated Wireless Mobile Utility app (📖 93).

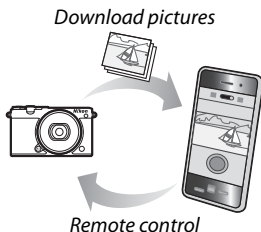

🔪 Installing the Wireless Mobile Utility App

1 Find the app.

On the smart device, connect to the Google Play service, the App Store, or another app marketplace and search for "Wireless Mobile Utility". For more information, see the instructions provided with the smart device.

2 Install the app.

Read the app description and install the app. A pdf manual for the Wireless Mobile Utility is available for download at the following URLs:

- **Android:** <http://nikonimglib.com/ManDL/WMAU/>
- **iOS:** <http://nikonimglib.com/ManDL/WMAU-ios/>



Android



iOS



Wireless Security

At default settings, wireless security is not enabled. Enable wireless security on the camera before connecting.

■ Enabling Wireless Security

Follow the steps below to enable wireless security.

1 Select Wi-Fi connection type.

Select **Wi-Fi connection type** in the Wi-Fi menu.

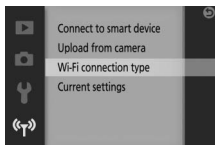

2 Enable encryption.

Select **Authentication/encryption** to display encryption options. Highlight **WPA2-PSK-AES** and press **OK** to enable wireless security. A password will now be required when connecting to the camera; the default password is "NIKON_J5" (the current password can be viewed at any time by selecting **Current settings** in the Wi-Fi menu). To allow connection without a password, select **Open** for **Authentication/encryption**.

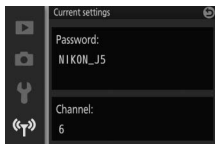
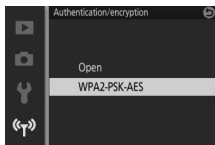
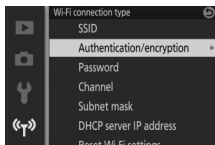

■ Changing the Password

The password can be changed as described below. The password can only be changed when **WPA2-PSK-AES** is selected for **Authentication/encryption** in the Wi-Fi menu.

1 Select Wi-Fi connection type > Password.

Select **Wi-Fi connection type** in the Wi-Fi menu, then highlight **Password** and press **OK**.

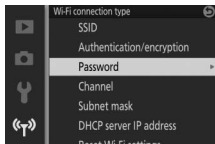

2 Enter a password.

The text-entry dialog shown at right will be displayed with the current password (by default, "NIKON_J5") in the password area. Tap to highlight characters in the password area or rotate the command dial to move the cursor. To enter a new character at the current cursor position, tap the keys in the keyboard area or highlight characters using the multi selector and press **OK**. To switch between lower and upper case, numbers, and symbols, press the **Fn** button or tap the shift key.

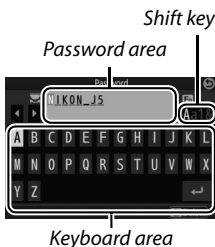

Passwords can be from 8 to 36 characters long. After entering the password, tap **Back**. The password can be viewed at any time by selecting **Current settings** in the Wi-Fi menu.

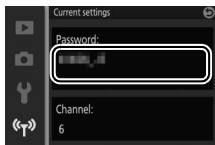



✓ Security

Although one of the benefits of a wireless-enabled device is that it allows others to freely connect for the wireless exchange of data anywhere within its range, the following may occur if security is not enabled:

- **Data theft:** Malicious third-parties may intercept wireless transmissions to steal user IDs, passwords, and other personal information.
- **Unauthorized access:** Unauthorized users may gain access to the network and alter data or perform other malicious actions. Note that due to the design of wireless networks, specialized attacks may allow unauthorized access even when security is enabled.

✎ Wi-Fi Connection Type

In addition to authentication/encryption and password options, the **Wi-Fi connection type** menu contains the following items:

- **SSID:** Choose the camera SSID (network name). The process for entering the SSID is the same as that for editing the password.
- **Channel:** The wireless channel used for wireless connections. Press  or  to choose from channels 1 through 11 and press  to select.
- **Subnet mask/DHCP server IP address:** We recommend that you use the default sub-net mask (255.255.255.0) and DHCP server IP address (192.168.0.1).
- **Reset Wi-Fi settings:** Select **Yes** to reset wireless settings to their default values.

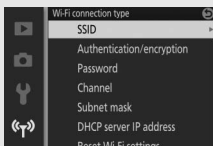

✎ Current Settings

Select **Current settings** to view the current SSID, authentication/encryption settings, password, channel, subnet mask, and DHCP server IP address.

Connecting via Wi-Fi

Before connecting via Wi-Fi (wireless LAN), install the Wireless Mobile Utility on your compatible Android or iOS smart device.

Android and iOS: Connecting via SSID

Enable Wi-Fi on the smart device before connecting. For details, see the documentation provided with the smart device.

1 Press the (Wi-Fi) button.

The camera SSID will be displayed (the camera SSID can also be displayed by highlighting **Connect to smart device** in the Wi-Fi menu and pressing .

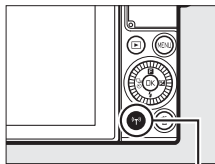

 (Wi-Fi) button



2 Select the camera SSID.

On the smart device, select **Settings** > **Wi-Fi** and select the camera SSID to connect via Wi-Fi. If this is the first time you have connected since changing password settings (📖 91), enter the new password when prompted.

3 Launch the Wireless Mobile Utility.

Launch the copy of Wireless Mobile Utility installed on the smart device. See Wireless Mobile Utility manual for details (📖 89).

Android: Connecting via NFC

If the smart device supports NFC (Near Field Communication), a Wi-Fi connection can be established simply by touching the camera  (N-Mark) logo to the smart device NFC antenna. Before connecting, enable NFC and Wi-Fi on the smart device as described in the documentation provided with the smart device.

To connect via NFC, touch the camera  (N-Mark) logo to the smart device NFC antenna (for the location of the NFC antenna, see the documentation provided with the smart device). Maintain contact until the camera displays a message stating that an NFC device has been detected.

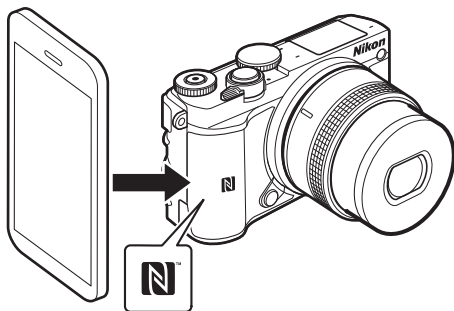

Once the smart device has been detected, a Wi-Fi connection will be established and the Wireless Mobile Utility will launch automatically. See the Wireless Mobile Utility manual for more information ( 89).

NFC

NFC (Near Field Communication) is an international standard for short-range wireless communications technology.

No Connection

If you are unable to establish a connection using NFC as described above, connect by manually selecting the camera SSID (☐ 93).

Wi-Fi

Before using the Wi-Fi function, read the warnings on pages xvi to xviii; to prevent loss of power while connected, you should also charge the camera battery. Do not use Wi-Fi in settings in which its use is prohibited. Note that the camera Wi-Fi function can not be used when a USB cable is connected.

Terminating Wi-Fi Connections

Wi-Fi will terminate automatically if the smart device does not initiate a connection within five minutes. To terminate Wi-Fi manually, press the MENU button to exit the Wi-Fi standby or connection display.



Uploading Photos to a Smart Device

Follow the steps below to upload photos from the camera to a smart device. Movies can not be selected for upload.

Uploading Photos One at a Time

Use the  (Wi-Fi) button to upload the photo currently displayed in full-frame playback.

1 Display the photo on the camera.

Display the desired photo in full-frame playback.

2 Press the (Wi-Fi) button.

Pressing the  (Wi-Fi) button initiates a Wi-Fi connection; the camera SSID will be displayed in the monitor.

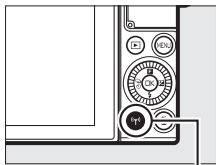

 (Wi-Fi) button

3 Select the camera SSID.

On the smart device, select **Settings > Wi-Fi** and select the camera SSID to connect via Wi-Fi. If this is the first time you have connected since changing password settings (91), enter the new password when prompted.

4 Download the photo to the smart device.

Launch the Wireless Mobile Utility on the smart device and follow the instructions on page 99 to download the photo.

The (Feature) Menu

Photos can also be uploaded by pressing **F** in full-frame playback and then highlighting **Wi-Fi upload** and pressing .

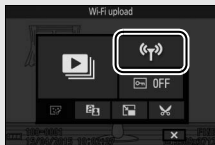

Uploading Multiple Selected Photos

To upload multiple selected photos, use the **Upload from camera** option in the Wi-Fi menu.

1 Choose **Upload from camera**.



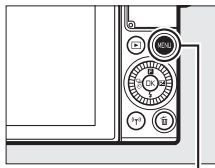

Press the MENU button to display the menus. Highlight **Upload from camera** in the Wi-Fi menu and press .

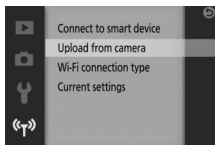

MENU button



2 Select photos.

Press  or  to scroll through pictures and press  to select or deselect. You can also tap the monitor to select or deselect photos. Selected photos are indicated by a  icon.

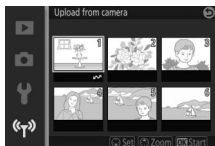

3 Press .

Press  to complete the operation. The camera SSID will be displayed in the monitor.

4 Select the camera SSID.

On the smart device, select **Settings** > **Wi-Fi** and select the camera SSID to connect via Wi-Fi. If this is the first time you have connected since changing password settings (📖 91), enter the new password when prompted.

5 Download the photos to the smart device.

Launch the Wireless Mobile Utility on the smart device and follow the instructions on page 99 to download the selected photos.

Uploading Photos via NFC

Photos displayed full frame or highlighted in the thumbnail list can be uploaded via NFC (📖 94).

1 Display or highlight the desired photo.

Display the photo full frame or highlight it in the thumbnail list.



2 Connect.

Touch the camera **N** (N-Mark) logo to the smart device NFC antenna until the camera displays a message stating that an NFC device has been detected.

3 Download the photos to the smart device.

The Wireless Mobile Utility will launch automatically on the smart device; follow the instructions on page 99 to download the selected photos.

Downloading Selected Pictures to the Smart Device

To download the selected pictures to the smart device, establish a Wi-Fi connection with the camera (☞ 93, 94) and select **View photos** in the Wireless Mobile Utility. A confirmation dialog will be displayed; select **OK** to download the pictures selected with the camera.

Android OS

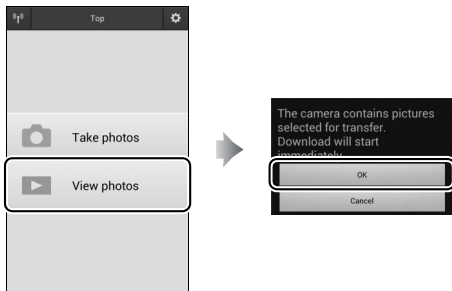

iOS

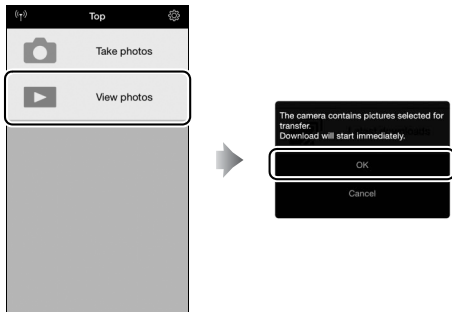

Menu Options

To display the playback, shooting, setup, and Wi-Fi menus, press the MENU button. Following menu options are available:

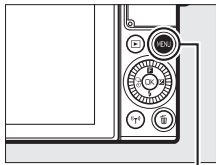

MENU button

■ Playback Menu Options

Option	Description
Delete	Delete multiple images.
Slide show	View movies and photos in a slide show.
Rotate tall	Rotate "tall" (portrait-orientation) pictures for display during playback.
Sequence display options	Choose how bursts are displayed.
Protect	Protect pictures from accidental deletion.
D-Lighting	Brighten shadows in dark or back-lit photos, creating a retouched copy that is saved separately from the unmodified original.
Resize	Create small copies of selected pictures.
Crop	Create cropped copies of selected pictures.
Edit movie	Create copies of movies from which unwanted footage has been trimmed.

■ Shooting Menu Options

Option	Description
Reset shooting options	Reset shooting options to default values.
Creative	Choose a creative mode.
Best moment capture	Choose from Active Selection , Slow view , and Smart Photo Selector .
Advanced movie	Choose a movie type for advanced movie mode.
Exposure mode	Choose how the camera sets shutter speed and aperture in Motion Snapshot mode (□ 65), when an option other than Time-lapse movie is selected in advanced movie mode (□ 38), and when Active Selection (□ 55) or Slow view (□ 59) is chosen in best moment capture mode.
Image quality	Choose a file format and compression ratio.
Image size	Choose a size for new photos.
Frame size/frame rate	Choose a frame size and rate for movies recorded in auto, P , S , A , M , and sports modes and when HD movie is selected in advanced movie mode (□ 38).
Metering	Choose how the camera meters exposure.
White balance	Adjust settings for different types of lighting.
ISO sensitivity	Control the camera's sensitivity to light.
Picture Control	Choose how the camera processes pictures.
Auto distortion control	Choose whether the camera corrects barrel and pin-cushion distortion.
Color space	Choose a color space for new pictures.
Active D-Lighting	Avoid loss of detail in highlights and shadows.
Long exposure NR	Reduce noise in long time-exposures.
High ISO noise reduction	Reduce noise at high ISO sensitivities.
Movie sound options	Choose sound recording options.
Auto image capture	Choose whether the camera takes photos automatically during movie recording and select the number of pictures taken per minute.



Option	Description
Interval timer shooting	Take photos at a pre-selected interval.
Optical VR	Choose whether to use optical vibration reduction with compatible 1 NIKKOR lenses.
Electronic VR (movies)	Choose whether to use electronic vibration reduction with Motion Snapshots or movies. In advanced movie mode, electronic VR applies only to movies recorded using the HD movie option (☐ 38).
Focus mode	Choose how the camera focuses.
AF-area mode	Choose how the focus area is selected.
Face-priority	Turn face priority on or off.
Built-in AF assist	Control the built-in AF-assist illuminator.
Flash control	Choose a flash mode for the built-in flash.
Flash compensation	Control flash output.

■ Setup Menu Options

Option	Description
Reset setup options	Reset setup menu options other than Flicker reduction , Time zone and date , and Language to default values.
Format memory card	Format the memory card.
Slot empty release lock	Allow the shutter to be released when no memory card is inserted in the camera.
Image review	Choose whether pictures are displayed after shooting.
Display	Adjust display brightness, view or hide a framing grid, and choose the information displayed in the monitor.
Sound settings	Choose the beeps made by the camera.
Auto power off	Choose the auto power off delay.

Option	Description
Self-portrait mode	Choose whether reversing the monitor causes the camera to enter self-portrait mode (📖 83).
Touch-screen controls	Enable or disable touch-screen controls.
Assign Fn button	Choose the role played by the Fn button.
Shutter button AE lock	Choose whether exposure locks when the shutter-release button is pressed halfway.
Flicker reduction	Reduce flicker or banding.
Reset file numbering	Reset file numbering.
Time zone and date	Set the camera clock.
Language	Choose a language for the camera displays.
Auto image rotation	Record camera orientation with pictures.
Pixel mapping	Check and optimize the camera image sensor and image processors.
Firmware version	Display the current firmware version.

■ ■ Wi-Fi Menu Options

Option	Description
Connect to smart device	Display the camera SSID for connection to a smart device.
Upload from camera	Upload images from the camera to the smart device.
Wi-Fi connection type	Edit the camera SSID, password, and other connection settings.
Current settings	View the camera SSID, password, and other connection settings.





Connecting to a Computer

Copying Pictures to a Computer

Pictures can be copied to a computer using ViewNX-i.

Installing ViewNX-i

To upload and view pictures, download the latest version of the ViewNX-i installer from the following website and follow the on-screen instructions to complete installation. An Internet connection is required. For system requirements and other information, see the Nikon website for your region (□ xv).

<http://downloadcenter.nikonimglib.com/>

Capture NX-D

Use Nikon's Capture NX-D software to fine-tune photos or to change settings for NEF (RAW) pictures and save them in other formats.

Capture NX-D is available for download from:

<http://downloadcenter.nikonimglib.com/>

Motion Snapshots

ViewNX-i is required to view Motion Snapshots saved using the **File format > NMS files** option (□ 68).



Copying Pictures to the Computer

Before proceeding, be sure you have installed ViewNX-i (📖 104).

1 Connect the USB cable.

After turning the camera off and ensuring that a memory card is inserted, connect the supplied USB cable as shown and then turn the camera on.

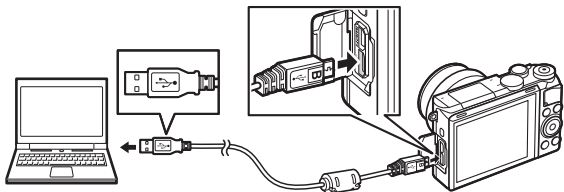

Use a Reliable Power Source

To ensure that data transfer is not interrupted, be sure the camera battery is fully charged.

Connecting Cables

Be sure the camera is off when connecting or disconnecting interface cables. Do not use force or attempt to insert the connectors at an angle.

During Transfer

Do not turn the camera off or disconnect the USB cable while transfer is in progress.

USB Hubs

Transfer may not proceed as expected if the camera is connected via a USB hub or keyboard.



2 Start Nikon Transfer 2 component of ViewNX-i.

If a message is displayed prompting you to choose a program, select Nikon Transfer 2.

Windows 7

If the following dialog is displayed, select Nikon Transfer 2 as described below.

- 1 Under **Import pictures and videos**, click **Change program**. A program selection dialog will be displayed; select **Import File using Nikon Transfer 2** and click **OK**.



- 2 Double-click **Import File**.

Windows 8.1

Windows 8.1 may display an AutoPlay prompt when the camera is connected. Tap or click the dialog and then tap or click **Import File/Nikon Transfer 2** to select Nikon Transfer 2.

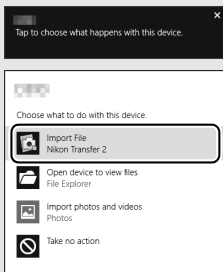

3 Click **Start Transfer**.

At default settings, pictures on the memory card will be copied to the computer.



Start Transfer

4 Terminate the connection.

When transfer is complete, turn the camera off and disconnect the USB cable.

For More Information

Consult online help for more information on using ViewNX-i.



Technical Notes

Read this chapter for information on compatible accessories, cleaning and storing the camera, and what to do if an error message is displayed or you encounter problems using the camera.

Optional Accessories

At the time of writing, the following accessories were available for your camera.

Lenses	1 mount lenses
Mount adapters	Mount Adapter FT1 Note: Some long telephoto lenses can not be used. See the <i>Reference Manual</i> for more information.
Power sources	<ul style="list-style-type: none">• Rechargeable Li-ion Battery EN-EL24 (□ 18–19): Additional EN-EL24 batteries are available from local retailers and Nikon-authorized service representatives.• Battery Charger MH-31 (□ 18): Recharge EN-EL24 batteries.• Power Connector EP-5F, AC Adapter EH-5b: These accessories can be used to power the camera for extended periods (EH-5a and EH-5 AC adapters can also be used). An EP-5F power connector is required to connect the camera to the EH-5b, EH-5a, or EH-5.
Body caps	Body Cap BF-N1000 : The body cap keeps the dust shield free of dust when a lens is not in place.
Nikon software for digital cameras	<ul style="list-style-type: none">• Capture NX-D: Fine-tune pictures taken with the camera and convert NEF (RAW) images to other formats.• ViewNX-i: Copy pictures to the computer for viewing.

Optional Accessories

Availability may vary with country or region. See our website or brochures for the latest information.

Approved Memory Cards

The following cards have been tested and approved for use in the camera. Cards with class 6 or faster write speeds are recommended for movie recording. Recording may end unexpectedly when cards with slower write speeds are used.

	microSDHC cards ¹	microSDXC cards ²
SanDisk	4 GB, 8 GB, 16 GB, 32 GB	64 GB, 128 GB
Toshiba		—
Panasonic		—
Lexar Media	8 GB, 16 GB, 32 GB	64 GB

1 Check that any card readers or other devices with which the card will be used are SDHC-compliant. The camera supports UHS-I.

2 Check that any card readers or other devices with which the card will be used are SDXC-compliant. The camera supports UHS-I.



Other cards have not been tested. For more details on the above cards, please contact the manufacturer.



Storage and Cleaning

Storage

If the camera will not be used for an extended period, remove the battery and store it in a cool, dry area with the terminal cover in place. To prevent mold or mildew, store the camera in a dry, well-ventilated area. Do not store your camera with naphtha or camphor moth balls or in locations that:

- are poorly ventilated or subject to humidities of over 60%
- are next to equipment that produces strong electromagnetic fields, such as televisions or radios
- are exposed to temperatures above +50 °C (122 °F) or below -10 °C (14 °F)

Cleaning

Camera body	Use a blower to remove dust and lint, then wipe gently with a soft, dry cloth. After using the camera at the beach or sea-side, wipe off sand or salt with a cloth lightly dampened in distilled water and dry thoroughly. Important: <i>Dust or other foreign matter inside the camera may cause damage not covered under warranty.</i>
Lens	Lenses are easily damaged. Remove dust and lint with a blower. If using an aerosol blower, keep the can vertical to prevent the discharge of liquid. To remove fingerprints and other stains, apply a small amount of lens cleaner to a soft cloth and clean with care.
Monitor	Remove dust and lint with a blower. When removing fingerprints and other stains, wipe the surface lightly with a soft cloth or chamois leather. Do not apply pressure, as this could result in damage or malfunction.
Dust shield	The dust shield is easily damaged. Remove dust and lint with a blower.

Do not use alcohol, thinner, or other volatile chemicals.

Caring for the Camera and Battery: Cautions

Do not drop: The product may malfunction if subjected to strong shocks or vibration.

Keep dry: This product is not waterproof, and may malfunction if immersed in water or exposed to high levels of humidity. Rusting of the internal mechanism can cause irreparable damage.

Avoid sudden changes in temperature: Sudden changes in temperature, such as those that occur when entering or leaving a heated building on a cold day, can cause condensation inside the device. To prevent condensation, place the device in a carrying case or plastic bag before exposing it to sudden changes in temperature.

Keep away from strong magnetic fields: Do not use or store this device in the vicinity of equipment that generates strong electromagnetic radiation or magnetic fields. Strong static charges or the magnetic fields produced by equipment such as radio transmitters could interfere with the display, damage data stored on the memory card, or affect the product's internal circuitry.

Keep the lens mount covered: Be sure to attach the body cap if the camera is without a lens.

Do not touch the dust shield: The dust shield covering the image sensor is easily damaged. Under no circumstances should you exert pressure on the shield or poke it with cleaning tools. These actions could scratch or otherwise damage the shield.

Turn the product off before removing or disconnecting the power source: Do not unplug the product or remove the battery while the product is on or while images are being recorded or deleted. Forcibly cutting power in these circumstances could result in loss of data or in damage to product memory or internal circuitry. To prevent an accidental interruption of power, avoid carrying the product from one location to another while the AC adapter is connected.



Cleaning: When cleaning the camera body, use a blower to gently remove dust and lint, then wipe gently with a soft, dry cloth. After using the camera at the beach or seaside, wipe off any sand or salt using a cloth lightly dampened in pure water and then dry the camera thoroughly.

Lenses are easily damaged. Dust and lint should be gently removed with a blower. When using an aerosol blower, keep the can vertical to prevent discharge of liquid. To remove fingerprints and other stains from the lens, apply a small amount of lens cleaner to a clean, soft cloth and wipe the lens carefully.

Storage: To prevent mold or mildew, store the camera in a cool, dry, well-ventilated area. If you are using an AC adapter, unplug the adapter to prevent fire. If the product will not be used for an extended period, remove the battery to prevent leakage and store the camera in a plastic bag containing a desiccant. Do not, however, store the camera case in a plastic bag, as this may cause the material to deteriorate. Note that desiccant gradually loses its capacity to absorb moisture and should be replaced at regular intervals.

To prevent mold or mildew, take the camera out of storage at least once a month. Turn the camera on and release the shutter a few times before putting it away.

Store the battery in a cool, dry place. Replace the terminal cover before putting the battery away.

Notes on the monitor: The monitor is constructed with extremely high precision; at least 99.99% of pixels are effective, with no more than 0.01% being missing or defective. Hence while these displays may contain pixels that are always lit (white, red, blue, or green) or always off (black), this is not a malfunction and has no effect on images recorded with the device.

Images in the monitor may be difficult to see in a bright light.

Do not apply pressure to the display, as this could cause damage or malfunction. Dust or lint on the display can be removed with a blower. Stains can be removed by wiping lightly with a soft cloth or chamois leather. Should the monitor break, care should be taken to avoid injury from broken glass and to prevent liquid crystal from the display touching the skin or entering the eyes and mouth.



Do not leave the lens pointed at the sun:

Do not leave the lens pointed at the sun or other strong light source for an extended period. Intense light may cause the image sensor to deteriorate or produce a white blur effect in photographs.

Moiré: Moiré is an interference pattern created by the interaction of an image containing a regular, repeating grid, such as the pattern of weave in cloth or windows in a building, with the camera image sensor grid. In some cases, it may appear in the form of lines. If you notice moiré in your photographs, try changing the distance to the subject, zooming in and out, or changing the angle between the subject and the camera.

Lines: Noise in the form of lines may in rare cases appear in pictures of extremely bright or backlit subjects.

Batteries: Batteries may leak or explode if improperly handled. Observe the following precautions when handling batteries:

- Use only batteries approved for use in this equipment.
- Do not expose the battery to flame or excessive heat.
- Keep the battery terminals clean.
- Turn the product off before replacing the battery.

- Do not use the battery at ambient temperatures below 0°C (32°F) or above 40°C (104°F); failure to observe this precaution could damage the battery or impair its performance. Capacity may be reduced and charging times may increase at battery temperatures from 0°C (32°F) to 10°C (50°F) and from 45°C (113°F) to 60°C (140°F); the battery will not charge if its temperature is below 0°C (32°F) or above 60°C (140°F).
- Remove the battery from the camera or charger when not in use and replace the terminal cover. These devices draw minute amounts of charge even when off and could draw the battery down to the point that it will no longer function. If the battery will not be used for some time, insert it in the camera and run it flat before removing it and storing it in a location with an ambient temperature of 15 °C to 25 °C (59 °F to 77 °F; avoid hot or extremely cold locations). Repeat this process at least once every six months.
- Turning the camera on and off repeatedly when the battery is fully discharged will shorten battery life. Batteries that have been fully discharged must be charged before use.



- The internal temperature of the battery may rise while the battery is in use. Attempting to charge the battery while the internal temperature is elevated will impair battery performance, and the battery may not charge or charge only partially. Wait for the battery to cool before charging.
- Continuing to charge the battery after it is fully charged can impair battery performance.
- A marked drop in the time a fully charged battery retains its charge when used at room temperature indicates that it requires replacement. Purchase a new EN-EL24 battery.
- Charge the battery before use. When taking photographs on important occasions, ready a spare EN-EL24 battery and keep it fully charged. Depending on your location, it may be difficult to purchase replacement batteries on short notice. Note that on cold days, the capacity of batteries tends to decrease. Be sure the battery is fully charged before taking photographs outside in cold weather. Keep a spare battery in a warm place and exchange the two as necessary. Once warmed, a cold battery may recover some of its charge.
- Used batteries are a valuable resource; recycle in accord with local regulations.

The battery charger: Charge the battery at ambient temperatures between 5°C (41°F) and 35°C (95°F). If the **CHARGE** lamp flashes quickly during charging, cease use immediately and take battery and charger to your retailer or a Nikon-authorized service representative.

Do not move the charger or touch the battery during charging. Failure to observe this precaution could in very rare instances result in the charger showing that charging is complete when the battery is only partially charged. Remove and reinsert the battery to begin charging again.

Use the charger with compatible batteries only. Unplug when not in use.

Memory Cards:

- Do not remove memory cards from the camera, turn the camera off, or remove or disconnect the power source during formatting or while data are being recorded, deleted, or copied to a computer. Failure to observe these precautions could result in loss of data or in damage to the camera or card.
- Do not touch the card terminals with your fingers or metal objects.



- Do not bend, drop, or subject to strong physical shocks.
- Do not apply force to the card casing. Failure to observe this precaution could damage the card.
- Do not expose to water, heat, high levels of humidity, or direct sunlight.
- Do not format memory cards in a computer.

Servicing the Camera and Accessories

The camera is a precision device and requires regular servicing. Nikon recommends that the camera be inspected by the original retailer or Nikon-authorized service representative once every one to two years, and that it be serviced once every three to five years (note that fees apply to these services). Frequent inspection and servicing are particularly recommended if the camera is used professionally. Any accessories regularly used with the camera, such as lenses, should be included when the camera is inspected or serviced.



Troubleshooting

If the camera fails to function as expected, check this list of common problems before consulting your retailer or Nikon representative.

Battery/Display

The camera is on but does not respond: Wait for recording or any other processing to end. If the problem persists, turn the camera off. If the camera still does not respond, remove and replace the battery or disconnect and reconnect the AC adapter, but note that this will delete any data not yet saved. Data already saved to the memory card are unaffected.

The display is off:

- The camera is off (☐ 22) or the battery is exhausted (☐ 4, 18).
 - The display has turned off automatically to save power (☐ 22). The display can be reactivated by pressing the shutter-release button.
 - The camera is connected to a computer (☐ 105) or television.
-

The camera turns off without warning:

- The battery is low (☐ 4, 18).
 - The display has turned off automatically to save power (☐ 22). The display can be reactivated by pressing the shutter-release button.
 - The camera's internal temperature is high (☐ xiii, 120). Wait for the camera to cool before turning it on again.
-

Indicators are not displayed: Use the **Display > Shooting** and **Display > Playback** options in the setup menu to choose the information displayed (☐ 102).

Shooting (All Modes)

The camera takes time to turn on: Delete files or format the memory card.

The shutter-release is disabled:

- The battery is exhausted (☐ 4, 18).
 - The memory card is full (☐ 24).
 - The flash is charging (☐ 81).
 - The camera is not in focus (☐ 26).
 - You are currently filming a slow-motion, 4K, or time-lapse movie (☐ 35).
-



Only one picture is taken each time the shutter-release button is pressed in continuous release mode:  is selected in continuous mode ([□ 73](#)) and the built-in flash is raised.

Smudges appear in photographs: Clean the front and rear lens elements or the dust shield ([□ 110](#)).

Flicker or banding appears in movies or in the display: Choose a **Flicker reduction** setting that matches the local AC power supply ([□ 103](#)).

No flash: See page 82. The flash will not fire when off ([□ 78](#)); in **P, S, A, M**, and self-portrait modes, the flash will not fire when lowered.

Menu items are grayed out and unavailable: Some options are only available in particular shooting or exposure modes.

Movies

Cannot record movies: The movie-record button can not be used to record movies in best moment capture or Motion Snapshot mode ([□ 58, 66](#)).

No sound is recorded for movies:

- **Microphone off** is selected for **Movie sound options > Microphone** ([□ 101](#)).
- Live audio is not recorded with time-lapse, slow-motion, fast-motion, or jump-cut movies ([□ 38](#)) or with Motion Snapshots recorded with **None** selected for **Audio** ([□ 68](#)).

Tap Shooting Options

The touch screen can not be used for shooting or focus:

- Touch shooting options are not available in best moment capture or Motion Snapshot mode.
- The edges of the display can not be used for shooting or focus. Tap closer to the center of the display.

Pictures are blurred: The camera may move when the display is tapped, which may under some conditions result in blurred pictures. Use both hands to hold the camera steady.



Playback

“Tall” (portrait) orientation photos are displayed in “wide” (landscape) orientation:

- Select **On** for **Rotate tall** (☐ 100).
- The photos were taken with **Auto image rotation** off (☐ 103).
- Camera was pointed up or down when the photo was taken.
- Photo is displayed in image review.

Cannot hear movie sound:

- Rotate the command dial right to raise the volume (☐ 36). If the camera is connected to a television, use the controls for the TV to adjust the volume.
- Live audio is not recorded with time-lapse, slow-motion, fast-motion, or jump-cut movies (☐ 38) or with Motion Snapshots recorded with **None** selected for **Audio** (☐ 68).

Cannot delete images: Remove protection from the files before deletion (☐ 100).

Wi-Fi (Wireless Networks)

Smart devices do not display the camera SSID (network name):

- Confirm that camera Wi-Fi is enabled (☐ 93).
- Try turning the smart device Wi-Fi off and then on again.

Can not connect to smart devices using NFC (☐ 94): Connect using the camera SSID (☐ 95).

Miscellaneous



The date of recording is not correct: Set the camera clock.

Menu items are grayed out and unavailable: Some options are only available at particular settings or when a memory card is inserted.

Error Messages

This section lists the error messages that appear in the display.

Message	Solution
(Shutter-speed or aperture display flashes)	<p>If the subject is too bright, lower ISO sensitivity or choose a faster shutter speed or smaller aperture (higher f-number).</p> <p>If the subject is too dark, raise ISO sensitivity, use the flash, or choose a slower shutter speed or larger aperture (lower f-number).</p>
Keeping the zoom ring button pressed, rotate the zoom ring to extend the lens.	A lens with a retractable lens barrel button is attached with the lens barrel retracted. Keeping the retractable lens barrel button pressed, rotate the zoom ring to extend the lens.
Check lens. Pictures can only be taken when a lens is attached.	Attach a lens.
Lens error. Try again after turning the camera off and on.	Turn the camera off and then on again. If the problem persists or reoccurs frequently, contact a Nikon-authorized service representative.
The clock has been reset.	Set the camera clock.
No memory card.	Turn the camera off and confirm that the card is correctly inserted.
This memory card cannot be used. Card may be damaged; insert a different card.	<ul style="list-style-type: none">• Use an approved card.• Format the card. If the problem persists, the card may be damaged. Contact a Nikon-authorized service representative.• Insert a new memory card.



Message	Solution
This memory card is not formatted. Format the memory card?	Select Yes to format the card, or turn the camera off and insert another memory card.
Memory card is full.	<ul style="list-style-type: none"> • You may be able to record additional images if you reduce image quality or size. • Delete unwanted images. • Insert another memory card.
Cannot create additional folders on memory card.	If the current folder is numbered 999 and contains either 999 photographs or a photograph numbered 9999, the shutter-release button will be disabled and no further photographs can be taken. Choose Yes for Reset file numbering and then either format the current memory card or insert a new memory card.
The movie-record button cannot be used in this mode.	The movie-record button can not be used in best moment capture or Motion Snapshot modes.
Photographs cannot be recorded in this mode.	The shutter-release button can not be used to take photographs while a slow-motion, 4K, or time-lapse movie is being recorded.
The camera's internal temperature is high. The camera will now turn off.	Wait for the camera to cool.
Memory card contains no images.	To view pictures, insert a memory card containing images.
Cannot display this file.	The file has been created or modified on a computer or different make of camera, or is corrupt.



Specifications

Nikon 1 J5 Digital Camera

Type		
Type	Digital camera with support for interchangeable lenses	
Lens mount	Nikon 1 mount	
Effective angle of view	Approx. 2.7× lens focal length (35 mm format equivalent)	
Effective pixels	20.8 million	
Image sensor		
Image sensor	13.2 mm × 8.8 mm CMOS sensor (Nikon CX format)	
Total pixels	23.01 million	
Storage		
Image size (pixels)	Still images taken in auto, P, S, A, M, sports, best moment capture, and all creative modes other than easy panorama (aspect ratio 3 : 2)	
	• 5568 × 3712	• 4176 × 2784
	• 2784 × 1856	
	Still images taken in normal panorama mode with camera panned horizontally (aspect ratio 120 : 23)	
	4800 × 920	
	Still images taken in normal panorama mode with camera panned vertically (aspect ratio 8 : 25)	
	1536 × 4800	
	Still images taken in wide panorama mode with camera panned horizontally (aspect ratio 240 : 23)	
	9600 × 920	
	Still images taken in wide panorama mode with camera panned vertically (aspect ratio 4 : 25)	
	1536 × 9600	
	Still images taken during movie recording (aspect ratio 3 : 2)	
5568 × 3712		
Motion Snapshots (photo portion, aspect ratio 16 : 9)		
5568 × 3136		



Storage	
File format	<ul style="list-style-type: none"> • NEF (RAW): 12-bit, compressed • JPEG: JPEG-Baseline compliant with fine (approx. 1 : 4), normal (approx. 1 : 8) compression • NEF (RAW) + JPEG: Single photograph recorded in both NEF (RAW) and JPEG formats
Picture Control system	Standard, Neutral, Vivid, Monochrome, Portrait, Landscape; selected Picture Control can be modified
Media	microSD (micro Secure Digital), microSDHC, and microSDXC memory cards
File system	DCF 2.0, Exif 2.3, PictBridge
Shooting modes	
	<p> auto; sports; creative, with a choice of the following options: POP pop, RETRO retro, high-contrast monochrome, SEPIA nostalgic sepia, HDR HDR, easy panorama, soft, miniature effect, selective color, cross process, toy camera effect, cross screen, fisheye, skin softening, night landscape, night portrait, landscape, close-up, and portrait; P programmed auto with flexible program, S shutter-priority auto, A aperture-priority auto, and M manual; best moment capture (Active Selection, slow view and Smart Photo Selector); advanced movie (HD HD movie, 4K 4K movie, time-lapse movie, slow motion, jump cut, fast motion and 4-second movie); Motion Snapshot; self-portrait </p>
Shutter	
Type	Electronic shutter
Speed	$\frac{1}{16,000}$ –30 s in steps of $\frac{1}{3}$ EV; Bulb Note: Bulb ends automatically after approximately 2 minutes
Flash sync speed	Synchronizes with shutter at $X=\frac{1}{60}$ s or slower



Release	
Mode	<ul style="list-style-type: none"> • Single frame, continuous • Self-timer • Interval timer shooting
Frame advance rate	Approx. 5, 10, 20, 30, or 60 fps
Self-timer	2 s, 10 s
Exposure	
Metering	TTL metering using image sensor
Metering method	<ul style="list-style-type: none"> • Matrix • Center-weighted: Meters 4.5 mm circle in center of frame • Spot: Meters 2 mm circle centered on selected focus area
Mode	P programmed auto with flexible program; S shutter-priority auto; A aperture-priority auto; M manual;  scene auto selector
Exposure compensation	-3 – +3 EV in increments of 1/3 EV
Exposure lock	Luminosity locked at metered value when shutter-release button is pressed halfway
ISO sensitivity (Recommended Exposure Index)	ISO 160; ISO 200–12800 in steps of 1 EV; 6400 (NR); 12800 (NR); auto ISO sensitivity control (ISO 160–6400, 160–3200, 160–800) available (user controlled in exposure modes P , S , A , and M)
Active D-Lighting	On, off



Focus	
Autofocus	Hybrid autofocus (phase-detection/contrast-detect AF); AF-assist illuminator
Lens servo	<ul style="list-style-type: none"> • Autofocus (AF): Single AF (AF-S); continuous AF (AF-C); auto AF-S/AF-C selection (AF-A); full-time AF (AF-F) • Manual focus (MF)
AF-area mode	Single-point, auto-area, subject tracking
Focus area	<ul style="list-style-type: none"> • Single-point AF: 171 focus areas; the center 105 areas support phase-detection AF • Auto-area AF: 41 focus areas
Focus lock	Focus can be locked by pressing shutter-release button halfway (single AF)
Face priority	On, off
Flash	
Built-in flash	<ul style="list-style-type: none"> • Auto and all creative modes other than HDR, easy panorama, landscape, and night landscape: Flash pops up automatically and fires as required • P, S, A, M, and self-portrait: Manual
Guide Number (GN)	Approx. 5/16 (m/ft, ISO 100, 20 °C/68 °F; at ISO 160, Guide Number is approx. 6.3/20.7)
Control	i-TTL flash control using image sensor
Mode	Auto, auto + red-eye reduction, fill flash, fill flash + slow sync, red-eye reduction, red-eye reduction + slow sync, rear-curtain sync, rear curtain + slow sync, off
Flash compensation	-3 to +1 EV in increments of 1/3 EV
Flash-ready indicator	Lights when built-in flash unit is fully charged
White balance	Auto, incandescent, fluorescent, direct sunlight, flash, cloudy, shade, preset manual, all except preset manual with fine tuning



Movie	
Metering	TTL metering using image sensor
Metering method	<ul style="list-style-type: none"> • Matrix • Center-weighted: Meters 4.5 mm circle in center of frame • Spot: Meters 2 mm circle centered on selected focus area
Frame size (pixels)/ recording rate	HD movies (aspect ratio 16 : 9)
	<ul style="list-style-type: none"> • 1920 × 1080/60p (59.94 fps) • 1920 × 1080/30p (29.97 fps) • 1280 × 720/60p (59.94 fps) • 1280 × 720/30p (29.97 fps)
	4K movies (aspect ratio 16 : 9)
	3840 × 2160/15p (14.99 fps)
	Slow-motion movies
	<ul style="list-style-type: none"> • 1280 × 720/120 fps (aspect ratio 16 : 9; plays at 30p/29.97 fps) • 800 × 296/400 fps (aspect ratio 8 : 3; plays at 30p/29.97 fps) • 400 × 144/1200 fps (aspect ratio 8 : 3; plays at 30p/29.97 fps)
	Time-lapse, fast-motion, jump-cut, and 4-second movies (aspect ratio 16 : 9)
1920 × 1080/30p (29.97 fps)	
Motion Snapshots (movie portion, aspect ratio 16 : 9)	
1920 × 1080/60p (59.94 fps) (plays at 24p/23.976 fps)	
File format	MOV
Video compression	H.264/MPEG-4 Advanced Video Coding
Audio recording format	PCM
Audio recording device	Built-in stereo microphone; sensitivity adjustable
Monitor	7.5 cm (3-in.), approx. 1037k-dot, tilting TFT LCD touch screen with brightness adjustment



Playback	Full-frame and thumbnail (4, 9, or 16 images or calendar) playback with playback zoom, bursts shown as key frames or as consecutive pictures, movie and panorama playback, slide show, histogram display, and auto image rotation
Interface	
USB	Hi-Speed USB
HDMI output	Type D HDMI connector
Wireless	
Standards	IEEE 802.11b, IEEE 802.11g
Operating frequency	2412–2462 MHz (channels 1–11)
Range (line of sight)	Approximately 10 m/33 ft (assumes no interference; range may vary with signal strength and presence or absence of obstacles)
Data rate	54 Mbps Maximum logical data rates according to IEEE standard. Actual rates may differ.
Authentication	Open system, WPA2-PSK
Access protocols	Infrastructure
NFC	
Operation	NFC Forum Type 3 Tag
Supported languages	Arabic, Bulgarian, Chinese (Simplified and Traditional), Czech, Danish, Dutch, English, Finnish, French, German, Greek, Hindi, Hungarian, Indonesian, Italian, Japanese, Korean, Norwegian, Persian, Polish, Portuguese (European and Brazilian), Romanian, Russian, Serbian, Spanish, Swedish, Thai, Turkish, Ukrainian, Vietnamese
Power source	
Battery	One rechargeable Li-ion EN-EL24 battery
AC adapter	EH-5b AC adapter; requires EP-5F power connector (available separately)
Tripod socket	1/4-in. (ISO 1222)



Dimensions/weight	
Dimensions (W × H × D)	Approx. 98.3 × 59.7 × 31.5 mm (3.9 × 2.4 × 1.3 in.), excluding projections
Weight	Approx. 265 g (9.4 oz) with battery and memory card but without body cap; approx. 231 g (8.2 oz), camera body only

Operating environment	
Temperature	0 °C–40 °C (+32 °F–104 °F)
Humidity	85% or less (no condensation)

- Unless otherwise stated, all measurements are performed in conformity with Camera and Imaging Products Association (CIPA) guidelines.
- All figures are for a camera with a fully-charged battery.
- Nikon reserves the right to change the specifications of the hardware and software described in this manual at any time and without prior notice. Nikon will not be held liable for damages that may result from any mistakes that this manual may contain.

MH-31 battery charger	
Rated input	AC 100–240 V, 50–60 Hz, 0.2 A
Rated output	DC 8.4 V/0.6 A
Supported batteries	Nikon EN-EL24 rechargeable Li-ion batteries
Charging time	Approx. 2 hours and 30 minutes at an ambient temperature of 25 °C (77 °F) when no charge remains
Operating temperature	0 °C–40 °C (+32 °F–104 °F)
Dimensions (W × H × D)	Approx. 67 × 28 × 94 mm (2.7 × 1.2 × 3.8 in.), excluding plug adapter
Weight	Approx. 83 g (3.0 oz), excluding plug adapter

EN-EL24 rechargeable Li-ion battery	
Type	Rechargeable lithium-ion battery
Rated capacity	7.2 V, 850 mAh
Operating temperature	0 °C–40 °C (+32 °F–104 °F)
Dimensions (W × H × D)	Approx. 29 × 47 × 13 mm (1.2 × 1.9 × 0.6 in.)
Weight	Approx. 34 g (1.2 oz), excluding terminal cover



1 NIKKOR VR 10–30mm f/3.5–5.6 PD-ZOOM

Type	1 mount lens
Focal length	10–30 mm
Maximum aperture	f/3.5–5.6
Construction	9 elements in 7 groups (including 4 aspherical lens elements, 1 ED lens element, and HRI lens elements)
Angle of view	77°–29° 40'
Vibration reduction	Lens shift using voice coil motors (VCMs)
Minimum focus distance	0.2 m (0.7 ft) from focal plane at all zoom positions
Diaphragm blades	7 (rounded diaphragm opening)
Diaphragm	Fully automatic
Aperture range	• 10 mm focal length: f/3.5–16 • 30 mm focal length: f/5.6–16
Dimensions	Approx. 58 mm diameter × 28 mm (distance from camera lens mount flange when lens is retracted)
Weight	Approx. 85 g (3.0 oz)

1 NIKKOR VR 30–110mm f/3.8–5.6

Type	1 mount lens
Focal length	30–110 mm
Maximum aperture	f/3.8–5.6
Construction	18 elements in 12 groups (including 2 ED lens elements)
Angle of view	29° 40'–8° 20'
Vibration reduction	Lens shift using voice coil motors (VCMs)
Minimum focus distance	1.0 m (3.3 ft) from focal plane at all zoom positions
Diaphragm blades	7 (rounded diaphragm opening)
Diaphragm	Fully automatic
Aperture range	• 30 mm focal length: f/3.8–16 • 110 mm focal length: f/5.6–16
Filter-attachment size	40.5 mm (P=0.5 mm)
Dimensions	Approx. 60 mm diameter × 61 mm (distance from camera lens mount flange when lens is retracted)
Weight	Approx. 180 g (6.3 oz)



1 NIKKOR VR 10–100mm f/4–5.6

Type	1 mount lens
Focal length	10–100 mm
Maximum aperture	f/4–5.6
Construction	19 elements in 12 groups (including 3 aspherical lens elements, 2 ED lens elements, and HRI lens elements)
Angle of view	77°–9° 10'
Vibration reduction	Lens shift using voice coil motors (VCMs)
Minimum focus distance	<ul style="list-style-type: none">• 10 mm focal length: 0.35 m (1.1 ft) from focal plane• 60 mm focal length: 1.0 m (3.3 ft) from focal plane• 100 mm focal length: 0.65 m (2.1 ft) from focal plane
Diaphragm blades	7 (rounded diaphragm opening)
Diaphragm	Fully automatic
Aperture range	<ul style="list-style-type: none">• 10 mm focal length: f/4–16• 100 mm focal length: f/5.6–16
Filter-attachment size	55 mm (P=0.75 mm)
Dimensions	Approx. 60.5 mm diameter × 70.5 mm (distance from camera lens mount flange when lens is retracted)
Weight	Approx. 298 g (10.5 oz)

Specifications subject to change without notice. Nikon will not be held liable for damages that may result from any mistakes that this manual may contain.



Trademark Information

IOS is a trademark or registered trademark of Cisco Systems, Inc., in the United States and/or other countries and is used under license. Windows is either a registered trademark or a trademark of Microsoft Corporation in the United States and/or other countries. PictBridge logo is a trademark. The microSD, microSDHC, and microSDXC logos are trademarks of the SD-3C, LLC. HDMI, the HDMI logo and High-Definition Multimedia Interface are trademarks or registered trademarks of HDMI Licensing, LLC.

HDMI

Wi-Fi and the Wi-Fi logo are trademarks or registered trademarks of the Wi-Fi Alliance. N-Mark is a trademark or registered trademark of NFC Forum, Inc., in the United States and/or other countries. All other trade names mentioned in this manual or the other documentation provided with your Nikon product are trademarks or registered trademarks of their respective holders.



📄 Certificates

- México

COFETEL: RCPNIDW12-1580

DW092

- Brasil



📄 FreeType License (FreeType2)

Portions of this software are copyright © 2012 The FreeType Project (<http://www.freetype.org>). All rights reserved.

📄 MIT License (HarfBuzz)

Portions of this software are copyright © 2015 The HarfBuzz Project (<http://www.freedesktop.org/wiki/Software/HarfBuzz>). All rights reserved.



Battery Life

The number of shots or movie footage that can be recorded with fully-charged batteries varies with the condition of the battery, temperature, the interval between shots, and the length of time menus are displayed. Sample figures for EN-EL24 (850 mAh) batteries are given below.

- **Still images: Approximately 250 shots**
- **Movies: Approximately 60 minutes at 1080/30p**

Measured according to CIPA standards at 23 ± 2 °C (73.4 ± 3.6 °F) with the camera at default settings, a fully-charged battery, a 1 NIKKOR VR 10–30mm f/3.5–5.6 PD-ZOOM lens, and a 16 GB SanDisk SDSDQXP-016G-J35A UHS-I microSDHC card. Value for still images obtained under the following test conditions: photographs taken at intervals of 30 s with the built-in flash fired with every other shot and the camera turned off and then on after every ten shots. Value for movies obtained under the following test conditions: a series of 17 minute movies with a file size of up to 4 GB were recorded; recording was only interrupted when temperature warning was displayed.

The following can reduce battery life:





























- Keeping the shutter-release button pressed halfway
- Repeated autofocus operations
- Taking NEF (RAW) photographs
- Slow shutter speeds
- Using Wi-Fi
- Using vibration reduction mode with VR lenses
- Using zoom with power zoom lenses













To ensure that you get the most from rechargeable Nikon EN-EL24 batteries:

- Keep the battery contacts clean. Soiled contacts can reduce battery performance.
- Use batteries immediately after charging. Batteries will lose their charge if left unused.

Index

Symbols

 (Auto mode)	6, 25
 (Advanced movie mode)	7, 38
 (Creative mode)	6, 41
P (Programmed auto)	49
S (Shutter-priority auto)	50
A (Aperture-priority auto)	51
M (Manual)	52
 (Sports mode)	6, 53
 (Best moment capture mode) .	7, 55
 (Motion Snapshot mode)	7, 65
 (HD movie)	34, 38
 (4K movie)	38
 (Time-lapse movie)	38
 (Slow motion)	38
 (Fast motion)	39
 (Jump cut)	39
 (4-second movie)	39
POP (Pop)	42
RETRO (Retro)	42
 (High-contrast monochrome) .	42
SEPIA (Nostalgic sepia)	42
 (HDR)	42, 44
 (Soft)	42
 (Easy panorama)	42, 45
 (Miniature effect)	42
 (Selective color)	42, 48
 (Cross process)	42
 (Toy camera effect)	43
* (Cross screen)	43
 (Fisheye)	43
 (Skin softening)	43
 (Night landscape)	30, 43
 (Night portrait)	30, 43
 (Landscape)	30, 43
 (Close-up)	30, 43
 (Portrait)	30, 43
 (Auto)	30
* (flexible program)	49

MENU (menu) button	8, 100
 (playback) button	28, 63, 69
 (delete) button	29, 37, 64, 69
 (Wi-Fi) button	93, 96
 (feature)	10
 (continuous shooting/self-timer) .	53, 73, 75
 (continuous)	73
 (self-timer)	75
 (flash mode)	78, 80
 (red-eye reduction)	78, 80
SLOW (slow sync)	80
REAR (rear-curtain sync)	80
 (flash-ready indicator)	81
 (Creative palette)	72
 (Single frame)	74

Numerics

4K movie	38
4-second movie	39

A

AC adapter	108
Accessories	108
Active selection	55
Advanced movie mode	7, 38
Aperture	51, 52
Aperture-priority auto	51
Attaching the lens	20
Audio	68
Auto mode	6, 25
Auto power off	22
Automatic scene selection	30

B

Battery	4, 18, 19, 108, 127
Beep	26, 76
Best moment capture mode	7, 55
Best shot	61, 63
Body cap	1, 2, 108
Buffering	56, 62, 66

Built-in flash 77

C

Capture NX-D 104

Charging a battery 18

Clock 23

Close-up 30, 43

Command dial 2, 28, 49, 50, 52

Connect to smart device 93

Continuous 53, 73

Creative mode 6, 41

Creative palette 72

Cross process 42

Cross screen 43

Current settings 92

D

Date and time 23

Date format 23

Daylight saving time 23

Delete 29, 37, 64, 69

Detailed display 4

Dust shield 2, 110, 111

E

Easy panorama 42, 45

Exposure compensation (self-
portraits) 84

Exposure indicator 52

F

Face priority 31

Fast motion 39

File format 68

Fill flash 80

Filter strength (Fisheye) 43

Filter strength (Skin softening) 43

Filter strength (Soft) 42

Firmware version 103

Fisheye 43

Flash 77

Flash mode 78, 80

Flash range 82

Flash-ready indicator 81

Flexible program 49

Focal plane mark 2

Focus area 26

Format memory card 19

Full-frame playback 28

G

Grid display 27

H

H.264 125

HD movies 34, 38

HDR 42, 44

High-contrast monochrome 42

Hue (Cross process) 42

Hue (Retro) 42

J

Jump cut 39

L

Landscape 30, 43

Language 23

Lens 20, 31, 108, 128, 129

Live image control 70

M

Manual 52

Maximum aperture 128, 129

Memory card 19, 109

Memory card access lamp 27

Microphone 33

Miniature effect 42

Monitor 4, 11, 83

Motion Snapshot mode 7, 65

Mount adapter 108

MOV 68, 125

Movie before/after 67

Movie-record button 2, 33

Movies 32

N

NFC 94, 98



Night landscape	43
Night portrait	43
Nikon Transfer 2	106
N-Mark	2, 94
NMS	68
Nostalgic sepia	42

P

Playback	28
Pop	42
Portrait	30, 43
Portrait (Soft)	42
Power connector	108
Power drive zoom	31
Power switch	22
Press the shutter-release button all the way down	27, 30
Press the shutter-release button halfway	26, 30
Programmed auto	49

R

Rear-curtain sync	80
Red-eye reduction	78, 80
Reset setup options	102
Retro	42

S

Saturation (Toy camera effect)	43
Scene selection	42
Select color	48
Select to send to smart device	97
Selective color	42, 48
Self-portrait mode	12, 83
Self-timer	75
Self-timer (self-portraits)	84
Shutter speed	50, 52
Shutter-priority auto	50
Shutter-release button	26, 30, 56, 60, 62, 66
Single frame	74
Size	121, 125
Skin softening	43

Skin softening (self-portraits)	84
Slow motion (advanced movie mode)	38
Slow sync	80
Slow view	59
Smart device	89
Smart Photo Selector	61
Soft	42
Speaker	3
Sports mode	6, 53
SSID	93
Strap	18

T

Tap shooting options	86
Temperature warnings	xiii
Tilting monitor	11, 83
Time	23
Time-lapse movie	38
Timer	75
Touch screen	13
Toy camera effect	43

U

Upload from camera	97
USB	105
USB cable	105

V

ViewNX-i	104
Vignetting	43
Volume	36

W

Wi-Fi	xvi, 89
Wi-Fi connection type	90, 92
Wi-Fi menu	90, 97
Wi-Fi upload	96
Wireless	xvi, 89
Wireless Mobile Utility	89, 99
Wireless network	89
Wireless security	90



Z

Zoom ring	31
-----------------	----



No reproduction in any form of this manual, in whole or in part (except for brief quotation in critical articles or reviews), may be made without written authorization from NIKON CORPORATION.

NIKON CORPORATION

© 2015 Nikon Corporation

Printed in Singapore



SB5G02(11)
6MVA9511-02