

# ***Nikon***

DIGITAL CAMERA

# **1 v2**

## **User's Manual**



**En**

## Table of Contents

Getting the Most from Your Camera .....	3
Product Documentation .....	5
For Your Safety.....	6
Notices.....	9
<b>Introduction</b> .....	<b>14</b>
Package Contents.....	14
Parts of the Camera.....	15
The Camera Body .....	15
The Monitor .....	17
The Mode Dial .....	19
First Steps.....	20
The DISP (Display) Button .....	23
<b>Auto Mode</b> .....	<b>24</b>
Taking Photos in Auto Mode.....	24
Live Image Control.....	28
Viewing Photographs .....	30
Deleting Pictures .....	31
Recording Movies in Auto Mode .....	32
<b>P, S, A, and M Modes</b> .....	<b>33</b>
Taking Photos in P, S, A, and M Modes .....	34
P Programmed Auto .....	34
S Shutter-Priority Auto .....	35
A Aperture-Priority Auto .....	36
M Manual.....	37
Recording Movies in P, S, A, and M Modes.....	39

<b>Best Moment Capture Mode</b>	<b>40</b>
Slow View.....	40
Smart Photo Selector.....	43
Viewing Photos Taken with the Smart Photo Selector .....	45
Choosing the Best Shot .....	45
Deleting Pictures.....	46
<b>Advanced Movie Mode</b>	<b>47</b>
HD Movies.....	47
Slow Motion .....	51
Viewing Movies .....	54
Deleting Movies .....	55
<b>Motion Snapshot Mode</b>	<b>56</b>
Shooting in Motion Snapshot Mode .....	56
Viewing Motion Snapshots .....	59
Deleting Motion Snapshots .....	59
<b>More on Photography</b>	<b>60</b>
Single-Frame, Continuous, Self-Timer, and Remote Control Modes.....	60
Continuous Mode.....	60
Self-Timer and Remote Control Modes .....	62
The Built-in Flash.....	65
Choosing a Flash Mode .....	66
<b>Menu Guide</b>	<b>68</b>
Playback Menu Options .....	70
Shooting Menu Options.....	70
Setup Menu Options.....	72

<b>Connecting to a Computer</b>	<b>73</b>
Installing the Supplied Software .....	73
System Requirements.....	74
Viewing and Editing Pictures on a Computer .....	75
Transferring Pictures .....	75
Viewing Pictures .....	76
<b>Technical Notes</b>	<b>78</b>
Optional Accessories .....	78
Approved Memory Cards .....	80
Storage and Cleaning .....	81
Storage.....	81
Cleaning.....	81
Caring for the Camera and Battery: Cautions .....	82
Troubleshooting .....	86
Battery/Display.....	86
Shooting (All Modes) .....	87
Movies .....	87
Playback.....	88
Miscellaneous .....	88
Error Messages.....	89
Specifications .....	91
Nikon 1 V2 Digital Camera .....	91
Battery Life.....	99
Index .....	100

## Getting the Most from Your Camera

**Take photos** with the shutter-release button.

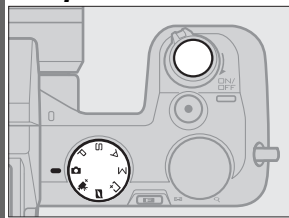

Photos can be taken in any mode by pressing the shutter-release button. In **Motion Snapshot mode** (📖 56), the camera will also record a brief movie vignette.

**Shoot movies** with the movie-record button.

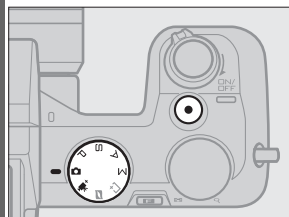

Movies can be recorded by pressing the movie-record button in auto, advanced movie, P, S, A, and M modes. Choose **auto mode** (📖 24) for basic recording, **advanced movie mode** (📖 47) for more advanced techniques.

Thank you for your purchase of a Nikon digital camera. For a complete guide to using your digital camera, see the *Reference Manual* (on CD). To get the most from your camera, please be sure to read this *User's Manual* thoroughly and keep it where it will be read by all who use the product.

### Camera Settings

The explanations in this manual assume that default settings are used.

### Symbols and Conventions

To make it easier to find the information you need, the following symbols and conventions are used:



This icon marks cautions; information that should be read before use to prevent damage to the camera.



This icon marks notes; information that should be read before using the camera.



This icon marks references to other pages in this manual.

The lens generally used in this manual for illustrative purposes is a 1 NIKKOR VR 10–30mm f/3.5–5.6.

### Digitutor

“Digitutor”, a series of “watch and learn” manuals in movie form, is available from the following website:

[http://www.nikondigitutor.com/index\\_eng.html](http://www.nikondigitutor.com/index_eng.html)

### For Your Safety

Before using the camera for the first time, read the safety instructions in “For Your Safety” (□ 6–8) and “Caring for the Camera and Battery: Cautions” (□ 82).

## Product Documentation

The following documentation is supplied with the camera.

*User's Manual* (this manual)—Describes how to take and view pictures.

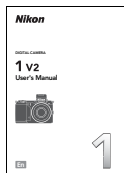

*Reference Manual* (on CD)—A complete guide to using your digital camera, included as a pdf file on the supplied Reference Manual CD-ROM.



The *Reference Manual* can be viewed using Adobe Reader or Adobe Acrobat Reader 5.0 or later, available for free download from the Adobe website.

- 1 Start the computer and insert the reference manual CD.
- 2 Double-click the CD (**Nikon 1 V2**) icon in Computer or My Computer (Windows) or on the desktop (Mac OS).
- 3 Double-click the **INDEX.pdf** icon to display a language selection screen and click a language to display the *Reference Manual*.

## For Your Safety

To prevent damage to your Nikon product or injury to yourself or to others, read the following safety precautions in their entirety before using this equipment. Keep these safety instructions where all those who use the product will read them.

The consequences that could result from failure to observe the precautions listed in this section are indicated by the following symbol:



This icon marks warnings. To prevent possible injury, read all warnings before using this Nikon product.

### ■ ■ ■ WARNINGS

- ⚠ **Keep the sun out of the frame.** Keep the sun well out of the frame when shooting backlit subjects. Sunlight focused into the camera when the sun is in or close to the frame could cause a fire.
- ⚠ **Do not look at the sun through the viewfinder.** Viewing the sun or other strong light source through the viewfinder could cause permanent visual impairment.
- ⚠ **Using the viewfinder diopter control:** When operating the viewfinder diopter control with your eye to the viewfinder, care should be taken not to put your finger in your eye accidentally.
- ⚠ **Turn off immediately in the event of malfunction.** Should you notice smoke or an unusual smell coming from the equipment or AC adapter (available separately), unplug the AC adapter and remove the battery immediately, taking care to avoid burns. Continued operation could result in injury. After removing the battery, take the equipment to a Nikon-authorized service center for inspection.
- ⚠ **Do not use in the presence of flammable gas.** Do not use electronic equipment in the presence of flammable gas, as this could result in explosion or fire.
- ⚠ **Do not disassemble.** Touching the product's internal parts could result in injury. In the event of malfunction, the product should be repaired only by a qualified technician. Should the product break open as the result of a fall or other accident, remove the battery and/or AC adapter and then take the product to a Nikon-authorized service center for inspection.
- ⚠ **Keep out of reach of children.** Failure to observe this precaution could result in injury. In addition, note that small parts constitute a choking hazard. Should a child swallow any part of this equipment, consult a physician immediately.
- ⚠ **Do not place the strap around the neck of an infant or child.** Placing the camera strap around the neck of an infant or child could result in strangulation.



**⚠ Do not remain in contact with the camera, battery, or charger for extended periods while the devices are on or in use.** Parts of the device become hot. Leaving the device in direct contact with the skin for extended periods may result in low-temperature burns.

**⚠ Do not aim the flash at the operator of a motor vehicle.** Failure to observe this precaution could result in accidents.

**⚠ Observe caution when using a flash.**

- Using the camera with the flash in close contact with the skin or other objects could cause burns.
- Using a flash close to the subject's eyes could cause temporary visual impairment. Particular care should be observed when photographing infants, when the flash should be no less than one meter (39 in.) from the subject.

**⚠ Avoid contact with liquid crystal.** Should the displays break, care should be taken to avoid injury due to broken glass and to prevent the liquid crystal from the displays touching the skin or entering the eyes or mouth.

**⚠ Observe proper precautions when handling batteries.** Batteries may leak or explode if improperly handled. Observe the following precautions when handling batteries for use in this product:

- Use only batteries approved for use in this equipment.
- Do not short or disassemble the battery.
- Be sure the product is off before replacing the battery. If you are using an AC adapter, be sure it is unplugged.

- Do not attempt to insert the battery upside down or backwards.
- Do not expose the battery to flame or to excessive heat.
- Do not immerse in or expose to water.
- Replace the terminal cover when transporting the battery. Do not transport or store the battery with metal objects such as necklaces or hairpins.
- Batteries are prone to leakage when fully discharged. To avoid damage to the product, be sure to remove the battery when no charge remains.
- When the battery is not in use, attach the terminal cover and store in a cool, dry place.
- The battery may be hot immediately after use or when the product has been used on battery power for an extended period. Before removing the battery turn the camera off and allow the battery to cool.
- Discontinue use immediately should you notice any changes in the battery, such as discoloration or deformation.

**⚠ Observe proper precautions when handling the charger:**

- Keep dry. Failure to observe this precaution could result in fire or electric shock.
- Do not short the charger terminals. Failure to observe this precaution could result in overheating and damage to the charger.
- Dust on or near the metal parts of the plug should be removed with a dry cloth. Continued use could result in fire.
- Do not go near the charger during thunderstorms. Failure to observe this precaution could result in electric shock.
- Do not handle the plug or charger with wet hands. Failure to observe this precaution could result in electric shock.
- Do not use with travel converters or adapters designed to convert from one voltage to another or with DC-to-AC inverters. Failure to observe this precaution could damage the product or cause overheating or fire.

**⚠ Use appropriate cables.** When connecting cables to the input and output jacks, use only the cables provided or sold by Nikon for the purpose to maintain compliance with product regulations.

**⚠ CD-ROMs:** CD-ROMs containing software or manuals should not be played back on audio CD equipment. Playing CD-ROMs on an audio CD player could cause hearing loss or damage the equipment.

## Notices

- No part of the manuals included with this product may be reproduced, transmitted, transcribed, stored in a retrieval system, or translated into any language in any form, by any means, without Nikon's prior written permission.
- Nikon reserves the right to change the specifications of the hardware and software described in these manuals at any time and without prior notice.
- Nikon will not be held liable for any damages resulting from the use of this product.
- While every effort has been made to ensure that the information in these manuals is accurate and complete, we would appreciate it were you to bring any errors or omissions to the attention of the Nikon representative in your area (address provided separately).

### **Notice for Customers in Canada**

#### **CAUTION**

This Class B digital apparatus complies with Canadian ICES-003.

#### **ATTENTION**

Cet appareil numérique de la classe B est conforme à la norme NMB-003 du Canada.

### **Notice for Customers in Europe**

**CAUTION: RISK OF EXPLOSION IF BATTERY IS REPLACED BY AN INCORRECT TYPE. DISPOSE OF USED BATTERIES ACCORDING TO THE INSTRUCTIONS.**

This symbol indicates that this product is to be collected separately.



The following apply only to users in European countries:

- This product is designated for separate collection at an appropriate collection point. Do not dispose of as household waste.
- For more information, contact the retailer or the local authorities in charge of waste management.

This symbol on the battery indicates that the battery is to be collected separately.



The following apply only to users in European countries:

- All batteries, whether marked with this symbol or not, are designated for separate collection at an appropriate collection point. Do not dispose of as household waste.
- For more information, contact the retailer or the local authorities in charge of waste management.

## Notice for Customers in the U.S.A.

The Battery Charger

# IMPORTANT SAFETY INSTRUCTIONS—SAVE THESE INSTRUCTIONS

## DANGER—TO REDUCE THE RISK OF FIRE OR ELECTRIC SHOCK, CAREFULLY FOLLOW THESE INSTRUCTIONS

For connection to a supply not in the U.S.A., use an attachment plug adapter of the proper configuration for the power outlet if needed. This power unit is intended to be correctly oriented in a vertical or floor mount position.

### Federal Communications Commission (FCC) Radio Frequency Interference Statement

This equipment has been tested and found to comply with the limits for a Class B digital device, pursuant to Part 15 of the FCC rules. These limits are designed to provide reasonable protection against harmful interference in a residential installation. This equipment generates, uses, and can radiate radio frequency energy and, if not installed and used in accordance with the instructions, may cause harmful interference to radio communications. However, there is no guarantee that interference will not occur in a particular installation. If this equipment does cause harmful interference to radio or television reception, which can be determined by turning the equipment off and on, the user is encouraged to try to correct the interference by one or more of the following measures:

- Reorient or relocate the receiving antenna.
- Increase the separation between the equipment and receiver.
- Connect the equipment into an outlet on a circuit different from that to which the receiver is connected.
- Consult the dealer or an experienced radio/television technician for help.



**Nikon**  
1 V2

#### CAUTIONS

##### *Modifications*

The FCC requires the user be notified that any changes or modifications made to this device that are not expressly approved by Nikon Corporation may void the user's authority to operate the equipment.

##### *Interface Cables*

Use the interface cables sold or provided by Nikon for your equipment. Using other interface cables may exceed the limits of Class B Part 15 of the FCC rules.

##### **Notice for Customers in the State of California**

**WARNING:** Handling the cord on this product may expose you to lead, a chemical known to the State of California to cause birth defects or other reproductive harm. *Wash hands after handling.*

Nikon Inc., 1300 Walt Whitman Road,  
Melville, New York 11747-3064, U.S.A.  
Tel.: 631-547-4200

## **Notice Concerning Prohibition of Copying or Reproduction**

Note that simply being in possession of material that has been digitally copied or reproduced by means of a scanner, digital camera, or other device may be punishable by law.

### **• Items prohibited by law from being copied or reproduced**

Do not copy or reproduce paper money, coins, securities, government bonds, or local government bonds, even if such copies or reproductions are stamped "Sample."

The copying or reproduction of paper money, coins, or securities which are circulated in a foreign country is prohibited.

Unless the prior permission of the government has been obtained, the copying or reproduction of unused postage stamps or post cards issued by the government is prohibited.

The copying or reproduction of stamps issued by the government and of certified documents stipulated by law is prohibited.

### **• Cautions on certain copies and reproductions**

The government has issued cautions on copies or reproductions of securities issued by private companies (shares, bills, checks, gift certificates, etc.), commuter passes, or coupon tickets, except when a minimum of necessary copies are to be provided for business use by a company. Also, do not copy or reproduce passports issued by the government, licenses issued by public agencies and private groups, ID cards, and tickets, such as passes and meal coupons.

### **• Comply with copyright notices**

The copying or reproduction of copyrighted creative works such as books, music, paintings, woodcuts, prints, maps, drawings, movies, and photographs is governed by national and international copyright laws. Do not use this product for the purpose of making illegal copies or to infringe copyright laws.

## **Disposing of Data Storage Devices**

Please note that deleting images or formatting memory cards or other data storage devices does not completely erase the original image data. Deleted files can sometimes be recovered from discarded storage devices using commercially available software, potentially resulting in the malicious use of personal image data. Ensuring the privacy of such data is the user's responsibility.

Before discarding a data storage device or transferring ownership to another person, erase all data using commercial deletion software, or format the device and then completely refill it with images containing no private information (for example, pictures of empty sky). Care should be taken to avoid injury when physically destroying data storage devices.

### **AVC Patent Portfolio License**

THIS PRODUCT IS LICENSED UNDER THE AVC PATENT PORTFOLIO LICENSE FOR THE PERSONAL AND NON-COMMERCIAL USE OF A CONSUMER TO (i) ENCODE VIDEO IN COMPLIANCE WITH THE AVC STANDARD (“AVC VIDEO”) AND/OR (ii) DECODE AVC VIDEO THAT WAS ENCODED BY A CONSUMER ENGAGED IN A PERSONAL AND NON-COMMERCIAL ACTIVITY AND/OR WAS OBTAINED FROM A VIDEO PROVIDER LICENSED TO PROVIDE AVC VIDEO. NO LICENSE IS GRANTED OR SHALL BE IMPLIED FOR ANY OTHER USE. ADDITIONAL INFORMATION MAY BE OBTAINED FROM MPEG LA, L.L.C. SEE <http://www.mpegla.com>

### **Temperature Warnings**

The camera may become warm to the touch during use; this is normal and does not indicate a malfunction. At high ambient temperatures, after extended periods of continuous use, or after several photographs have been taken in quick succession, a temperature warning may be displayed, following which the camera will turn off automatically to minimize damage to its internal circuits. Wait for the camera to cool before resuming use.

### **Use Only Nikon Brand Electronic Accessories**

Nikon cameras are designed to the highest standards and include complex electronic circuitry. Only Nikon brand electronic accessories (including chargers, batteries, AC adapters, and flash accessories) certified by Nikon specifically for use with this Nikon digital camera are engineered and proven to operate within the operational and safety requirements of this electronic circuitry.

The use of non-Nikon electronic accessories could damage the camera and may void your Nikon warranty. The use of third-party rechargeable Li-ion batteries not bearing the Nikon holographic seal shown at right could interfere with normal operation of the camera or result in the batteries overheating, igniting, rupturing, or leaking.

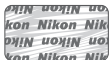

For more information about Nikon brand accessories, contact a local authorized Nikon dealer.

### **Use Only Nikon Brand Accessories**

Only Nikon brand accessories certified by Nikon specifically for use with your Nikon digital camera are engineered and proven to operate within its operational and safety requirements. THE USE OF NON-NIKON ACCESSORIES COULD DAMAGE YOUR CAMERA AND MAY VOID YOUR NIKON WARRANTY.

### **Servicing the Camera and Accessories**

The camera is a precision device and requires regular servicing. Nikon recommends that the camera be inspected by the original retailer or a Nikon-authorized service representative once every one to two years, and that it be serviced once every three to five years (note that fees apply to these services). Frequent inspection and servicing are particularly recommended if the camera is used professionally. Any accessories regularly used with the camera, such as lenses or optional flash units, should be included when the camera is inspected or serviced.

### **Before Taking Important Pictures**

Before taking pictures on important occasions (such as at weddings or before taking the camera on a trip), take a test shot to ensure that the camera is functioning normally. Nikon will not be held liable for damages or lost profits that may result from product malfunction.

### **Life-Long Learning**

As part of Nikon's "Life-Long Learning" commitment to ongoing product support and education, continually-updated information is available on-line at the following sites:

- **For users in the U.S.A.:** <http://www.nikonusa.com/>
- **For users in Europe and Africa:** <http://www.europe-nikon.com/support/>
- **For users in Asia, Oceania, and the Middle East:** <http://www.nikon-asia.com/>

Visit these sites to keep up-to-date with the latest product information, tips, answers to frequently-asked questions (FAQs), and general advice on digital imaging and photography. Additional information may be available from the Nikon representative in your area. For contact information, visit <http://imaging.nikon.com/>

# Introduction

## Package Contents

Confirm that the package contains the following items:

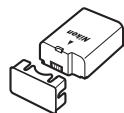
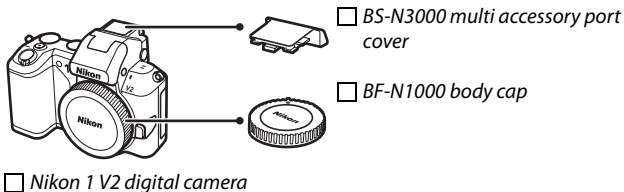

EN-EL21  
rechargeable  
Li-ion battery  
(with terminal cover)



MH-28 battery  
charger (AC wall  
adapter supplied in  
countries or regions where  
required; shape depends  
on country of sale)

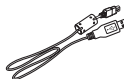

UC-E19  
USB cable



Lens (supplied only if  
lens kit is purchased with  
camera; comes with front  
and rear lens caps)

AN-N1000 strap  
 ViewNX 2/Short  
Movie Creator CD

Warranty  
 User's Manual  
(this manual)

Reference manual  
CD (contains the  
Reference Manual)

Memory cards are sold separately.



## Parts of the Camera

Take a few moments to familiarize yourself with camera controls and displays. You may find it helpful to bookmark this section and refer to it as you read through the rest of the manual.

### The Camera Body

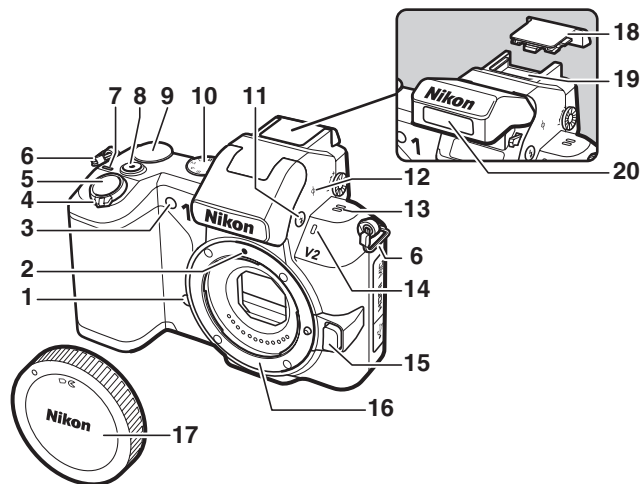

1 Infrared receiver .....	63, 87	10 Mode dial .....	19
2 Mounting mark .....	22	11  (flash) button .....	65
3 AF-assist illuminator		12 Focal plane mark (- $\infty$ )	
Self-timer lamp .....	62	13 Speaker	
Red-eye reduction lamp .....	65	14 Microphone	
4 Power switch .....	22	15 Lens release button	
5 Shutter-release		16 Lens mount .....	22
button .....	26, 41, 44, 49, 57	17 Body cap .....	79
6 Eyelet for camera strap .....	20	18 Multi accessory port cover	
7 Power lamp .....	22	19 Multi accessory port	
8 Movie-record button .....	32, 39, 48	20 Built-in flash .....	65
9 Command dial .....	30		

## The Camera Body (Continued)

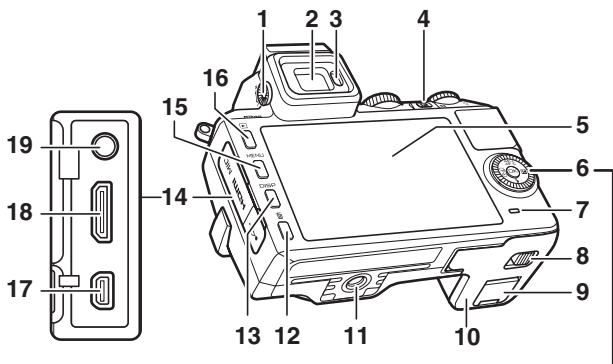

Press the multi selector up, down, left, or right (▲, ▼, ◀, or ▶), or rotate it as shown at right.



Ⓞ button

<b>1</b> Diopter adjustment control .....	18	<b>9</b> Power connector cover	for optional power connector
<b>2</b> Electronic viewfinder .....	18	<b>10</b> Battery-chamber/ memory card slot cover	
<b>3</b> Eye sensor .....	18	<b>11</b> Tripod socket *	
<b>4</b> (feature) button .....	28, 42, 50, 58	<b>12</b> (delete) button .....	31, 46, 55, 59
<b>5</b> Monitor .....	17, 23	<b>13</b> DISP (display) button .....	23
<b>6</b> Multi selector .....	69	<b>14</b> Connector cover	
Ⓞ (OK) button .....	69	<b>15</b> MENU (menu) button .....	68
(AE-L/AF-L)		<b>16</b> (playback) button .....	30, 45, 59
(exposure compensation)		<b>17</b> USB connector .....	75
(flash mode) .....	66	<b>18</b> HDMI mini-pin connector	
(continuous shooting/ self-timer) .....	60, 62	<b>19</b> Connector for external microphone .....	79
<b>7</b> Memory card access lamp .....	26		
<b>8</b> Battery-chamber/memory card slot cover latch			

\*TA-N100 tripod adapter not supported.

## The Monitor

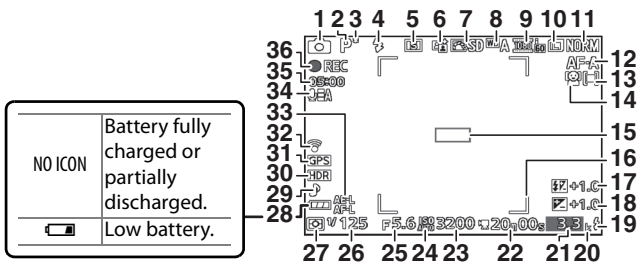

<b>1</b> Shooting mode .....	19	<b>21</b> Number of exposures remaining	19
<b>2</b> Exposure mode .....	70	Number of shots remaining	19
Live image control .....	28	before memory buffer fills	19
<b>3</b> Flexible program indicator .....	34	White balance recording indicator	19
<b>4</b> Flash mode .....	65	Card warning indicator	19
<b>5</b> Self-timer/remote control mode ....	60	<b>22</b> Time available.....	48, 52
Continuous mode * .....	60	<b>23</b> ISO sensitivity .....	71
<b>6</b> Active D-Lighting * .....	71	<b>24</b> ISO sensitivity indicator.....	71
<b>7</b> Picture Control * .....	71	Auto ISO sensitivity indicator	71
<b>8</b> White balance * .....	71	<b>25</b> Aperture.....	36, 37
<b>9</b> Movie settings (HD movies) * .....	71	<b>26</b> Shutter speed .....	35, 37
Frame rate		<b>27</b> Metering .....	71
(slow motion movies) * .....	71	<b>28</b> Battery indicator *	
<b>10</b> Image size * .....	70	<b>29</b> Silent photography * .....	70
<b>11</b> Image quality * .....	70	<b>30</b> HDR .....	71
<b>12</b> Focus mode * .....	71	<b>31</b> GPS connection indicator *	
<b>13</b> AF-area mode * .....	71	<b>32</b> Eye-Fi connection indicator *	
<b>14</b> Face-priority * .....	27, 71	<b>33</b> Autoexposure (AE)/autofocus (AF)	
<b>15</b> Focus area .....	26, 71	lock indicator	
<b>16</b> AF area brackets *		<b>34</b> Microphone sensitivity *	
<b>17</b> Flash compensation .....	71	<b>35</b> Time elapsed.....	48, 52
<b>18</b> Exposure compensation		<b>36</b> Recording indicator.....	48, 52
<b>19</b> Flash-ready indicator .....	65		
<b>20</b> "K" (appears when memory remains			
for over 1000 exposures)			

\* Available only in detailed display.

### **The Electronic Viewfinder**

Use the viewfinder when bright ambient lighting conditions make it difficult to see the display in the monitor. The viewfinder display turns on when you put your eye to the viewfinder and is identical to that shown on page 17; the monitor turns off automatically. Note that the monitor may turn off and the viewfinder turn on if you place your finger or other objects near the eye sensor; avoid covering the sensor when using the monitor.

To focus the display, use the diopter adjustment control. When operating the control with your eye to the viewfinder, be careful not to put your finger or fingernails in your eye.

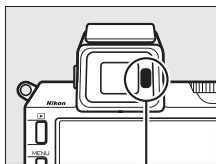

*Eye sensor*

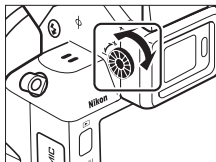

## The Mode Dial

The camera offers a choice of the following shooting modes:

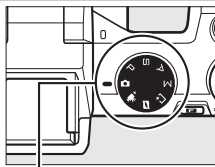

Mode dial

**Auto mode** (☐ 24): Let the camera pick the settings for photographs and movies.

**Advanced movie mode** (☐ 47): Choose the exposure mode for HD movies or shoot slow-motion movies.

**Motion Snapshot mode** (☐ 56): Each time the shutter is released, the camera records a still image and about 1.6 s of movie footage. When the resulting “Motion Snapshot” is viewed on the camera, the movie will play back in slow motion over approximately 4 s, followed by the still image.

**Best moment capture mode** (☐ 40): Choose the moment to release the shutter as the scene plays back in slow motion (slow view), or let the camera choose the best shot based on composition and motion (Smart Photo Selector).

**P, S, A, and M modes** (☐ 33): Control shutter speed and aperture for advanced photographic effects.

- **P**: Programmed auto (☐ 34)
- **S**: Shutter-priority auto (☐ 35)
- **A**: Aperture-priority auto (☐ 36)
- **M**: Manual (☐ 37)

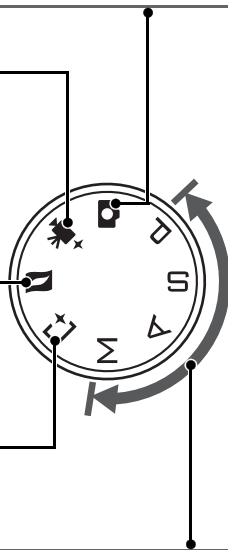

## First Steps

### 1 Attach the camera strap.

Attach the strap securely to the two camera eyelets.

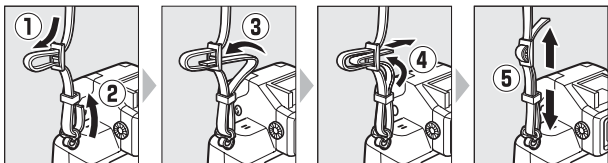

### 2 Charge the battery.

Insert the battery into the charger (1) and plug the charger in (2). An exhausted battery fully charges in about two hours. Unplug the charger and remove the battery when charging is complete.

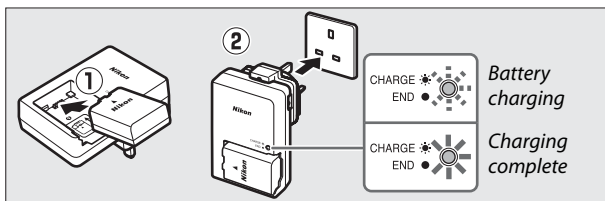

#### The Plug Adapter

Depending on the country or region of purchase, a plug adapter may be supplied with the charger. The shape of the adapter varies with the country or region of purchase. If a plug adapter is supplied, raise the wall plug and connect the plug adapter as shown at right, making sure the plug is fully inserted. Attempting to forcibly remove the plug adapter could damage the product.

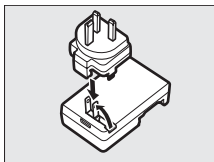

### 3 Insert the battery and a memory card.

Check to be sure the battery and card are in the correct orientation. Using the battery to keep the orange battery latch pressed to one side, slide the battery in until it latches, and then slide in the memory card until it clicks into place.

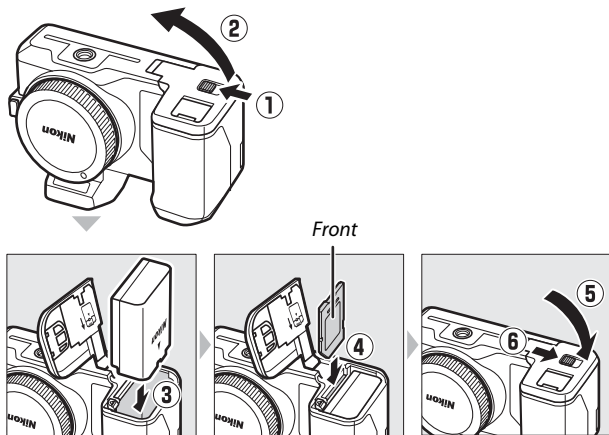

#### Formatting Memory Cards

If this is the first time the memory card will be used in the camera or if the card has been formatted in another device, select **Format memory card** in the setup menu and follow the on-screen instructions to format the card (72). *Note that this permanently deletes any data the card may contain.* Be sure to copy any photographs and other data you wish to keep to a computer before proceeding.



## 4 Attach a lens.

Be careful to prevent dust from entering the camera when the lens or body cap is removed.

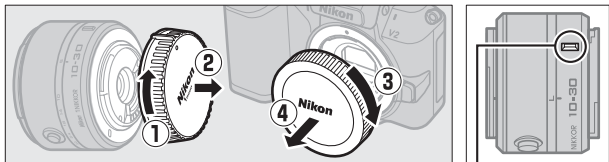

Mounting mark (lens)

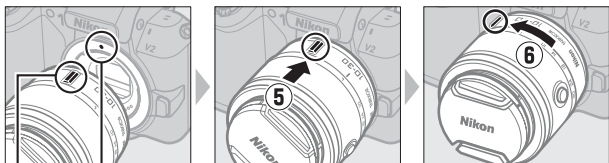

Mounting mark  
(camera)

Keeping marks aligned, position lens on camera, then rotate until it clicks into place.

Mounting mark (lens)

## 5 Turn the camera on.

Rotate the power switch to turn the camera on. The power lamp will briefly light green and the monitor will turn on. Be sure to remove the lens cap before shooting.

### Turning the Camera Off

To turn the camera off, rotate the power switch again. The monitor will turn off.

Check the battery level and number of exposures remaining in the monitor (17).

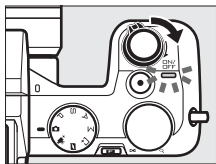

Battery level

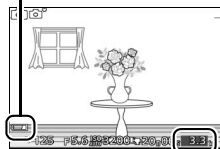

Exposures remaining



### Lenses with Retractable Lens Barrel Buttons

Lenses with retractable lens barrel buttons can not be used when retracted. To unlock and extend the lens, keep the retractable lens barrel button pressed (1) while rotating the zoom ring (2). The camera will turn on automatically when the retractable lens barrel lock is released. The lens can be retracted

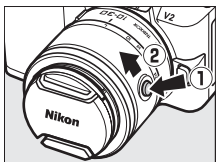

and the zoom ring locked by pressing the retractable lens barrel button and rotating the ring in the opposite direction. If the view through the lens is displayed or the monitor is off, the camera will turn off automatically when the lens barrel is locked (in the case of 1 NIKKOR VR 10–30mm f/3.5–5.6 and 1 NIKKOR VR 30–110mm f/3.8–5.6 lenses, firmware version 1.10 or later is required if locking the lens barrel is to turn the camera off when the monitor is off; for information on updating lens firmware, visit the Nikon website for your area). Be careful not to press the retractable lens barrel button while attaching or removing the lens. Retract the lens before removal.



### Choosing a Language and Setting the Camera Clock

A language-selection dialog will be displayed the first time the camera is turned on. Use the multi selector to choose a language, time zone, and date format, turn daylight saving time on or off, and set the camera's 24-hour clock, pressing  after each step to proceed to the next dialog.

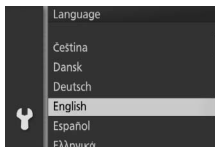

### **The DISP (Display) Button**

Press DISP to cycle through shooting or playback indicators.

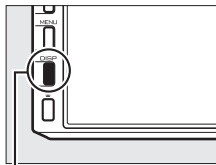

DISP button

# Auto Mode

Shoot photographs and movies. The camera automatically adjusts settings to suit the subject.

## Taking Photos in Auto Mode

### 1 Select auto mode.

Rotate the mode dial to .

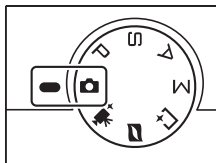

### 2 Ready the camera.

Hold the camera securely with both hands, being careful not to obstruct the lens, AF-assist illuminator, or microphone. Rotate the camera as shown at lower right when taking pictures in "tall" (portrait) orientation.

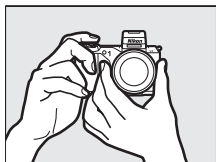

Shutter speeds slow when lighting is poor; use of the built-in flash ( 65) or a tripod is recommended.

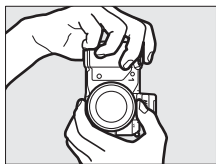

### 3 Frame the photograph.

Position your subject in the center of the frame.

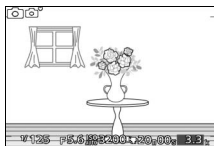

#### Using a Zoom Lens

Use the zoom ring to zoom in on the subject so that it fills a larger area of the frame, or zoom out to increase the area visible in the final photograph (select longer focal lengths on the lens focal length scale to zoom in, shorter focal lengths to zoom out).

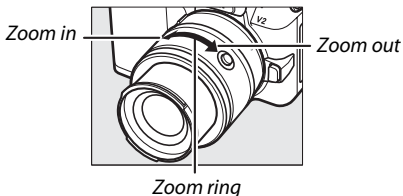

#### The Framing Grid

A framing grid can be displayed by selecting **On** for **Grid display** in the setup menu (72).

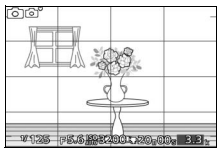

#### 4 Focus.

Press the shutter-release button half-way to focus. If the subject is poorly lit, the AF-assist illuminator (📖 15) may light to assist the focus operation.



**If the camera is able to focus**, the selected focus area will be highlighted in green and a beep will sound (a beep may not sound if the subject is moving).

**If the camera is unable to focus**, the focus area will be displayed in red.

Focus area

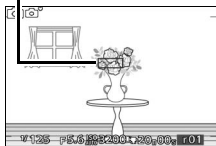

#### 5 Shoot.

Smoothly press the shutter-release button the rest of the way down to release the shutter and record the photograph. The memory card access lamp will light and the photograph will be displayed in the monitor for a few seconds (the photo will automatically clear from the display when the shutter-release button is pressed half-way). *Do not eject the memory card or remove or disconnect the power source until the lamp has gone out and recording is complete.*

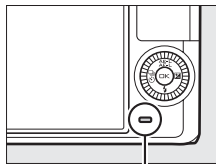

Memory card access lamp

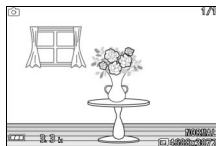

### **Face Priority**

The camera detects and focuses on portrait subjects (face priority). A double yellow border will be displayed if a portrait subject is detected facing the camera (if multiple faces, up to a maximum of five, are detected, the camera will select the closest subject). Press the shutter-release button halfway to focus on the subject in the double yellow border. The border will clear from the display if the camera can no longer detect the subject (because, for example, the subject has looked away).





### **Automatic Scene Selection**

In auto mode, the camera automatically analyzes the subject and selects the appropriate scene. The selected scene is shown in the monitor.

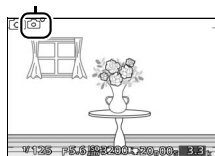
*Scene icon*



 **Portrait:** Human portrait subjects.

 **Landscape:** Landscapes and cityscapes.

 **Night portrait:** Portrait subjects framed against dark backgrounds.

 **Close up:** Subjects close to the camera.

 **Night landscape:** Poorly-lit landscapes and cityscapes.

 **Auto:** Subjects that do not fall into the categories listed above.

### **Auto Power Off**

If no operations are performed for about a minute, the displays will turn off and the power lamp start to flash. The camera can be reactivated by operating the buttons, mode dial, or other camera controls. If no operations are performed for about three minutes after the displays have turned off, the camera will turn off automatically.



## Live Image Control

Live image controls let you preview how changes to each control will affect the final photograph. To choose a live image control for auto mode, press **F** and use the command dial. Rotate the dial to highlight an item and press the dial to view the effect.

Rotate the command dial to adjust the selected item. To hide live image controls, press **F** again.

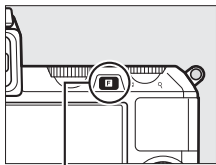

**F** button

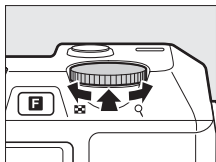

Command dial

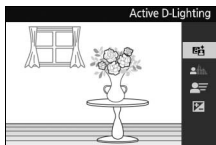

**Active D-Lighting:** Preserve details in high-lights and shadows for natural contrast.



Active D-Lighting: High



Active D-Lighting: Low

Increase effect

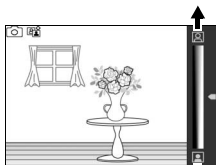

Reduce effect

**Background softening:** Soften background details to make your subject stand out, or bring both background and foreground into focus.



*Background sharp*



*Background softened*

*Sharpen background*

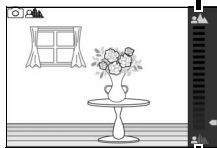

*Soften background*



**Motion control:** Suggest motion by blurring moving objects, or “freeze” motion to capture moving objects clearly.



*Freeze motion*

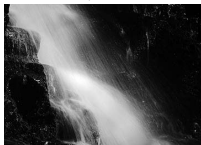

*Blur motion*

*Freeze motion*

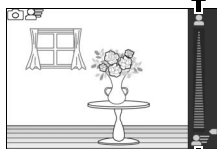

*Blur motion*

**Brightness control:** Make pictures brighter or darker.



*Brighter*



*Darker*

*Brighter*

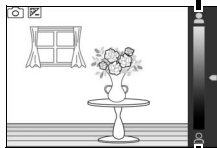

*Darker*

**Live Image Control**

When live image control is in effect, the built-in flash and optional flash units can not be used and only one picture will be taken each time the shutter-release button is pressed all the way down, even if  is selected in the continuous/self-timer menu.

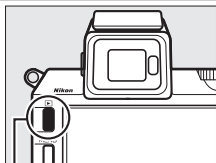

## Viewing Photographs

Press  to display your most recent photograph full frame in the monitor (full-frame playback).

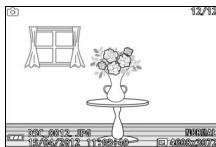

 button



Press  or  or rotate the multi selector to view additional pictures.



To zoom in on the center of the current image, rotate the command dial to the right. Rotate left to zoom out. To view multiple images, rotate the command dial left when the picture is displayed full frame.

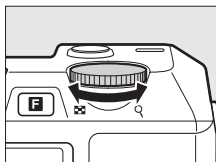

*Command dial*

To end playback and return to shooting mode, press the shutter-release button halfway.

### See Also

See page 70 for information on slide shows.



## Deleting Pictures

To delete the current picture, press . Note that once deleted, pictures can not be recovered.

### 1 Display the photograph.

Display the photograph you wish to delete as described on the preceding page.

### 2 Press .

A confirmation dialog will be displayed.

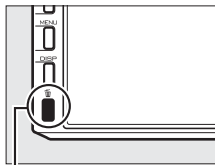

button

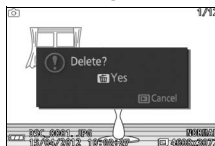

### 3 Delete the photograph.

Press again to delete the picture and return to playback, or press to exit without deleting the picture.

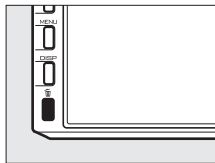

#### Deleting Multiple Pictures

The **Delete** option in the playback menu ( 70) can be used to delete selected pictures, all pictures, or pictures taken on selected dates.



## Recording Movies in Auto Mode

In auto mode, the movie-record button can be used to shoot movies with sound at an aspect ratio of 16 : 9 (the movie crop is shown in the display). Press the movie-record button to start and stop recording.

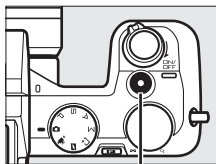

*Movie-record button*

### Taking Photographs During Recording

Photographs can be taken at any time during recording by pressing the shutter-release button all the way down. Movie recording is not interrupted.

### See Also

See page 54 for information on viewing movies.

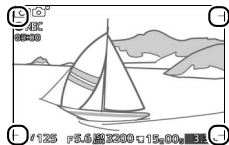

# P, S, A, and M Modes

P, S, A, and M modes offer varying degrees of control over shutter speed and aperture. Choose a mode and adjust settings according to your creative intent.

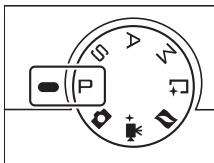

## Adjusting Settings

In P, S, A, and M modes, the settings below can be accessed directly from the shooting display. Press the **F** button and rotate the command dial to highlight a setting and press the dial to select.

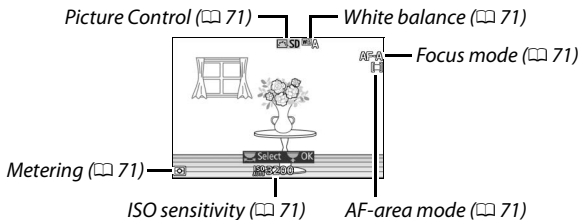

Once selected, the setting can be changed by rotating the command dial. Press the dial again to save changes and exit to shooting mode.

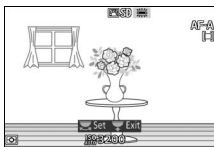

## Taking Photos in P, S, A, and M Modes

### P Programmed Auto

In this mode, the camera automatically adjusts shutter speed and aperture for optimal exposure in most situations. This mode is recommended for snapshots and other situations in which you want to leave the camera in charge of shutter speed and aperture.

PS  
AM

#### ■ Choosing a Combination of Shutter Speed and Aperture

Although the shutter speed and aperture chosen by the camera will produce optimal results, you can also choose from other combinations that will produce the same exposure (“flexible program”). Rotate the command dial right for large apertures (low f-numbers) that blur background details or fast shutter speeds that “freeze” motion. Rotate the dial left for small apertures (high f-numbers) that increase depth of field or slow shutter speeds that blur motion. \* is displayed while flexible program is in effect.

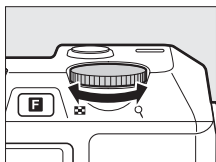

Command dial

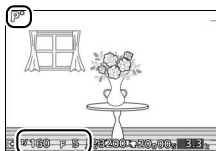

#### 🔧 Restoring Default Shutter Speed and Aperture Settings

To restore default shutter speed and aperture settings, rotate the command dial until \* is no longer displayed, choose another mode, rotate the mode dial, or turn the camera off. The default shutter speed and aperture is automatically restored when the camera enters standby mode.

## ☰ Shutter-Priority Auto

In shutter-priority auto, you choose the shutter speed while the camera automatically selects the aperture that will produce the optimal exposure. Use slow shutter speeds to suggest motion by blurring moving subjects, fast shutter speeds to “freeze” motion.



Fast shutter speed ( $1/1600$  s)

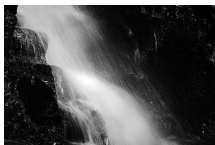

Slow shutter speed (1 s)

PS  
AM

### ■ Choosing a Shutter Speed

Rotate the command dial right for faster shutter speeds, left for slower shutter speeds. Choose from values between 30 s and  $1/4000$  s. The electronic shutter, which can be enabled either by selecting **On** for **Silent photography** (☞ 70) or by choosing a frame rate of 15, 30, or 60 fps (☞ 70) in continuous shooting mode (☞ 60), supports shutter speeds as fast as  $1/16,000$  s; the slowest shutter speed available with the electronic shutter is 30 s (silent photography) or  $1/60$  s (15, 30, and 60 fps continuous).

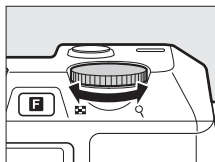

Command dial

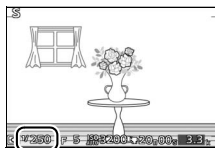

#### ☑ Continuous Shooting

The selected shutter speed may change when continuous shooting (☞ 60) is in effect.

## A Aperture-Priority Auto

In aperture-priority auto, you choose the aperture while the camera automatically selects the shutter speed that will produce the optimal exposure. Large apertures (low f-numbers) reduce depth of field, blurring objects behind and in front of the main subject. Small apertures (high f-numbers) increase depth of field, bringing out details in the background and foreground. Short field depths are generally used in portraits to blur background details, long field depths in landscape photographs to bring the foreground and background into focus.

PS  
AM



Large aperture (f/5.6)



Small aperture (f/16)

### ■ ■ Choosing an Aperture

Rotate the command dial right for smaller apertures (higher f-numbers), left for larger apertures (lower f-numbers). The minimum and maximum values depend on the lens currently in use.

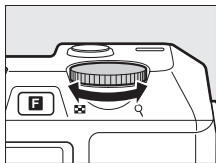

Command dial

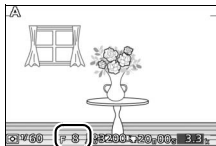

In manual exposure mode, you control both shutter speed and aperture.

### ■ ■ Choosing Shutter Speed and Aperture

Adjust shutter speed and aperture with reference to the exposure indicator (see below). Shutter speed is set by rotating the command dial right for faster speeds and left for slower speeds: choose from values between 30 s and  $\frac{1}{4000}$  s (30 s and  $\frac{1}{16,000}$  s when the electronic shutter is enabled by selecting **On** for **Silent photography**, or  $\frac{1}{60}$  s and  $\frac{1}{16,000}$  s when the electronic shutter is enabled by selecting a frame rate of 15, 30, or 60 fps in continuous shooting mode;  $\frac{1}{60}$ , 70), or select “Bulb” or “Time” to hold the shutter open indefinitely for a long time-exposure. Aperture is selected by rotating the multi selector clockwise for smaller apertures (higher f-numbers) and counterclockwise for larger apertures (lower f-numbers): choose from values between the minimum and maximum for the lens.

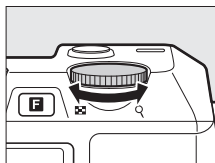

Command dial

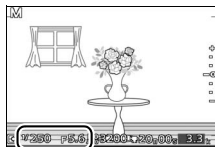

### The Exposure Indicator

When shutter speeds other than “Bulb” or “Time” are selected, the exposure indicator shows whether the photograph would be under- or over-exposed at current settings.

Optimal exposure	Underexposed by $\frac{1}{3}$ EV	Overexposed by over 2 EV
+ · · -0 · · -	+ · · =0 · · -	+ ▲ · · · · · -0 · · -

### Continuous Shooting

The selected shutter speed may change when continuous shooting ( 60) is in effect.



## Recording Movies in P, S, A, and M Modes

In P, S, A, and M modes, the movie-record button can be used to shoot movies with sound at an aspect ratio of 16 : 9 (the corners of the movie crop are shown in the display). Press the movie-record button to start and stop recording. Note that regardless of the mode selected, movies are recorded using programmed auto exposure; to adjust exposure when shooting movies, select advanced movie mode ( 47).

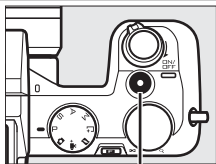

Movie-record button

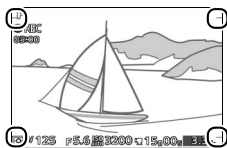

PS  
AM

### ▣ Taking Photographs During Recording

Photographs can be taken at any time during recording by pressing the shutter-release button all the way down. Movie recording is not interrupted.

### ▣ See Also

See page 54 for information on viewing movies.

# Best Moment Capture Mode

This mode is ideal for fast-changing, hard-to-capture subjects. Choose when to release the shutter as the scene plays back in slow motion (slow view), or let the camera choose the best shot based on composition and motion (Smart Photo Selector).

## Slow View

In this mode, the camera captures a short sequence of still images and plays them back in slow motion so that you can choose the precise moment for a photograph. While the shutter-release button is pressed halfway, the camera records up to 40 frames over about 1.3 s and plays them back in a continuous slow-motion loop. When the frame you want to keep is displayed, press the shutter-release button the rest of the way down to record the current frame and discard the remaining images.

### 1 Select mode.

Rotate the mode dial to .

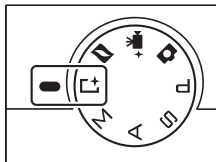

### 2 Frame the photograph.

Compose the photograph with your subject in the center of the frame.

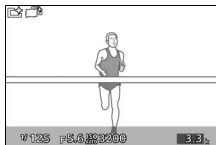

---

### 3 Press the shutter-release button halfway.

The camera will focus (🗨 26) and then, over a span of about 1.3 s, record 40 frames to a temporary memory buffer.



---

### 4 View the buffer contents.

Keep the shutter-release button pressed halfway to play the frames in the buffer back in a continuous loop about 6 s long. The position of the current frame is shown by a progress indicator.

*Progress indicator*



---

### 5 Record the desired frame.

Press the shutter-release button all the way down to record the current frame and discard the remaining images. To exit without recording a photograph, release the button without pressing it all the way down.

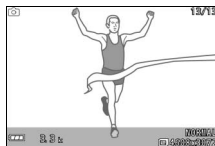

## ■ ■ Choosing a Capture Mode

Pressing the **F** button in best moment capture mode displays the following options. Rotate the command dial to highlight the desired capture mode and press the dial to select.

- **Slow view:** Take pictures in slow view mode (📖 40).
- **Smart Photo Selector:** Take pictures using the Smart Photo Selector (📖 43).

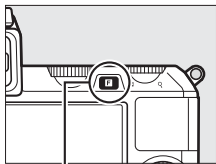

**F** button

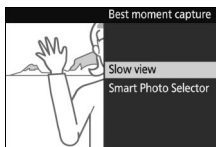

## Smart Photo Selector

Choose Smart Photo Selector mode to let the camera help you take photos that capture a fleeting expression on the face of a portrait subject or other hard-to-time shots such as group photos in party scenes. Each time the shutter is released, the camera automatically selects the best shot and a number of best shot candidates based on composition and motion.



### 1 Select mode.

Rotate the mode dial to .

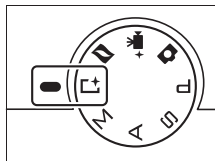

### 2 Select Smart Photo Selector mode.

Press , then rotate the command dial to highlight **Smart Photo Selector** and press the dial to select.

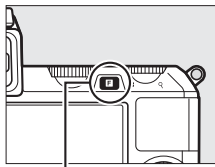

 button



---

### 3 Frame the photograph.

Compose the photograph with your subject in the center of the frame.



---

### 4 Begin buffering photographs.

Press the shutter-release button half-way to focus (□ 26). An icon will be displayed as the camera begins recording images to the memory buffer. The camera continuously adjusts focus to account for changes in the distance to the subject while the shutter-release button is pressed halfway.



---

### 5 Shoot.

Smoothly press the shutter-release button the rest of the way down. The camera will compare shots recorded to the buffer both before and after the shutter-release button was pressed all the way down, and select five to copy to the memory card. Note that some time may be required. The best picture is displayed in the monitor when recording is complete.



## Viewing Photos Taken with the Smart Photo Selector



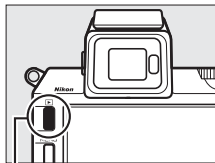

Press  and use the multi selector to display photographs taken with the Smart Photo Selector (📖 30; pictures taken with the Smart Photo Selector are indicated by a  icon). Of the photographs recorded by the Smart Photo Selector, only the best shot will be displayed (when you press the multi selector right to view the next picture, the camera will skip over the best shot candidates, with the result that the next picture displayed will not have a file number that immediately follows that of the current picture). To end playback and return to shooting mode, press the shutter-release button halfway.



▶ button



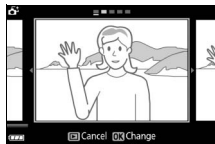

### Choosing the Best Shot

When a photograph taken with the Smart Photo Selector is displayed, you can choose the best shot by pressing . Press  or  to view the other pictures in the sequence and press  to select the current picture as the best shot. To return to normal playback, press .



## Deleting Pictures

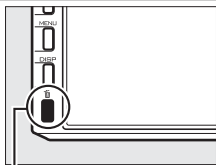

Pressing  when a picture taken with the Smart Photo Selector is selected displays a confirmation dialog; press  again to delete the best shot and the best shot candidates, or press  to exit without deleting the pictures. *Note that once deleted, pictures can not be recovered.*

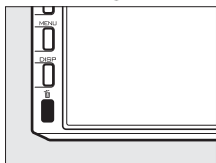

 button



### Deleting Individual Photographs

Pressing the  button in the best shot selection dialog displays the following options; highlight an option using the multi selector and press  to select.

- **This image:** Delete the current photo (note that the picture currently selected as the best shot can not be deleted).
- **All except best shot:** Delete the best shot candidates, but not picture currently selected as the best shot.

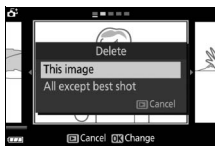

A confirmation dialog will be displayed; to delete the selected image or images, highlight **Yes** and press .

### Best Moment Capture Mode

The camera automatically chooses a scene mode appropriate to the subject. Movies can not be recorded, and pressing the movie-record button has no effect. The flash can not be used.



# Advanced Movie Mode

Choose this mode to film slow-motion movies or to shoot high-definition (HD) movies in mode P, S, A, or M.

## HD Movies

Record movies with sound at an aspect ratio of 16 : 9.

### 1 Select advanced movie mode.

Rotate the mode dial to +. An HD movie crop with an aspect ratio of 16 : 9 will appear in the display.

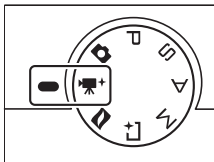

### 2 Frame the opening shot.

Frame the opening shot with your subject in the center of the display.

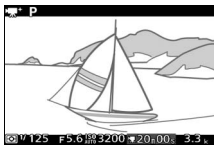

#### The Icon

A  icon indicates that movies can not be recorded.

#### See Also

For information on choosing an exposure mode, see page 70. Frame size and frame rate options are described on page 71.

### 3 Start recording.

Press the movie-record button to begin recording. A recording indicator, the time elapsed, and the time available are displayed while recording is in progress.

#### **Audio Recording**

Be careful not to cover the microphone and note that the built-in microphone may record sounds made by the camera or lens. By default, the camera focuses continuously. The **Movie sound options** item in the shooting menu offers sensitivity and wind noise options for both built-in and external microphones (☞ 79).

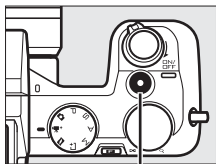

*Movie-record button*

*Recording indicator/  
Time elapsed*



*Time available*

### 4 End recording.

Press the movie-record button again to end recording. Recording will end automatically when the maximum length is reached, the memory card is full, another mode is selected, the lens is removed, or the camera becomes hot (☞ 12).

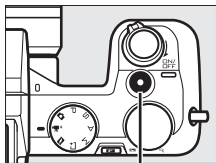

*Movie-record button*

#### **Maximum Length**

At default settings, HD movies can be up to 4 GB in size and 20 minutes in length; note that depending on memory card write speed, shooting may end before this length is reached (☞ 80).

#### **Focus and Exposure Lock**

Focus and exposure will lock while the  $\text{AE-L}$  (multi selector up) button is pressed.

## ■ Taking Photographs During HD Movie Recording

Press the shutter-release button all the way down to take a photograph without interrupting HD movie recording. Photographs taken during movie recording have an aspect ratio of 3 : 2.

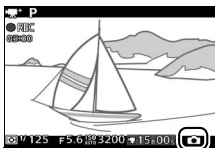

## ■ Taking Photographs During Movie Recording

Up to 20 photographs can be taken with each movie shot. Please note that photographs can not be taken with slow-motion movies.



## ■ Choosing the Movie Type

To choose between high definition and slow motion recording, press **F**, then rotate the command dial to highlight one of the following options and press the dial to select:

- **HD movie:** Record movies in HD (📖 47).
- **Slow motion:** Record slow-motion movies (📖 51).

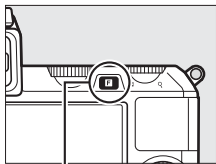

**F** button

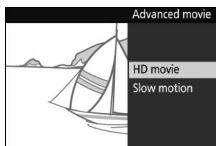

### ✓ Recording Movies

Flicker, banding, or distortion may be visible in the displays and in the final movie under fluorescent, mercury vapor, or sodium lamps or if the camera is panned horizontally or an object moves at high speed through frame (flicker and banding can be reduced in HD movies by choosing a **Flicker reduction** option that matches the frequency of the local AC power supply, but note that the slowest shutter speed available is  $\frac{1}{100}$  s at **50 Hz**,  $\frac{1}{60}$  s at **60 Hz**; 📖 72). Bright light sources may leave after-images when the camera is panned. Jagged edges, color fringing, moiré, and bright spots may also appear. When recording movies, avoid pointing the camera at the sun or other strong light sources. Failure to observe this precaution could result in damage to the camera's internal circuitry.

## Slow Motion

Record silent movies with an aspect ratio of 8 : 3. Movies are recorded at 400 fps and play back at 30 fps.

### 1 Select advanced movie mode.

Rotate the mode dial to .

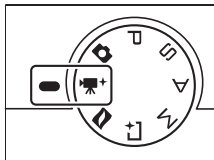

### 2 Select slow-motion mode.

Press the **F** button, then rotate the command dial to highlight **Slow motion** and press the dial to select. A slow-motion movie crop with an aspect ratio of 8 : 3 will appear in the display.

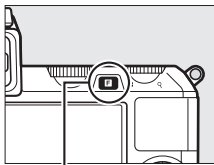

**F** button

### 3 Frame the opening shot.

Frame the opening shot with your subject in the center of the display.

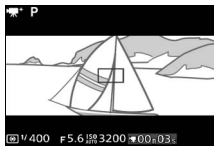

## 4 Focus.



*Focus area*

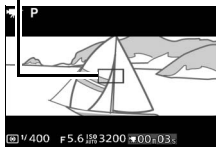

## 5 Start recording.

Press the movie-record button to begin recording. A recording indicator, the time elapsed, and the time available are displayed while recording is in progress. The camera focuses on the subject at the center of the display; face detection (27) is not available and focus and exposure can not be adjusted.

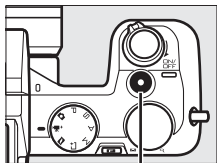

*Movie-record button*

*Recording indicator/  
Time elapsed*

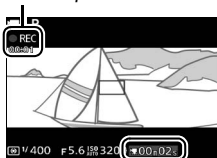

*Time available*

## 6 End recording.

Press the movie-record button again to end recording. Recording will end automatically when the maximum length is reached, the memory card is full, another mode is selected, the lens is removed, or the camera becomes hot (☞ 12).

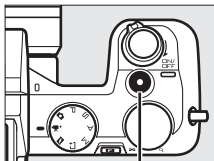

*Movie-record button*

### **Maximum Length**



Up to 3 seconds or 4 GB of footage can be recorded; note that depending on memory card write speed, shooting may end before this length is reached (☞ 80).

### **See Also**

Frame rate options are described on page 71.



## Viewing Movies

Movies are indicated by a  icon in full-frame playback ( 30). Press  to start playback.



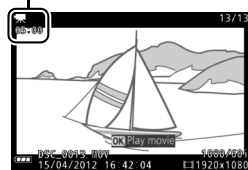



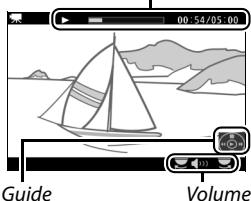



 icon/Length



Movie playback indicator/  
Current position/total length





The following operations can be performed:

To	Use	Description
Pause		Pause playback.
Play		Resume playback when the movie is paused or during rewind/advance.
Advance/ rewind	 / 	Press  to rewind,  to advance. Speed increases with each press, from 2x to 4x to 8x to 16x. If playback is paused, the movie rewinds or advances one frame at a time; keep the button pressed for continuous rewind or advance. You can also rotate the multi selector to rewind or advance when playback is paused.
Adjust volume		Rotate the command dial to adjust volume.
Return to full-frame playback	 / 	Press  or  to exit to full-frame playback.



## Deleting Movies

To delete the current movie, press . A confirmation dialog will be displayed; press  again to delete the movie and return to playback, or press  to exit without deleting the movie. *Note that once deleted, movies can not be recovered.*

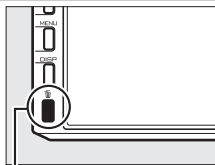

 button

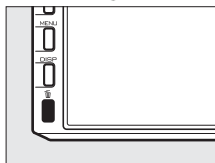

# Motion Snapshot Mode

Record brief movie vignettes with your photographs. Each time the shutter is released, the camera records a still image and about 1.6 s of movie footage. When the resulting “Motion Snapshot” is viewed on the camera, the movie will play back in slow motion over approximately 4 s, followed by the still image; playback is accompanied by a background track about 10 s long.

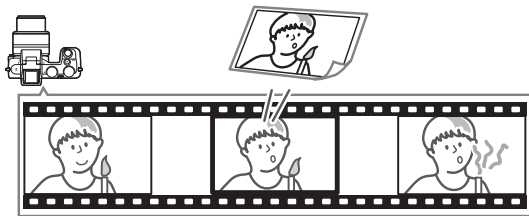

## Shooting in Motion Snapshot Mode

### 1 Select Motion Snapshot mode.

Rotate the mode dial to .

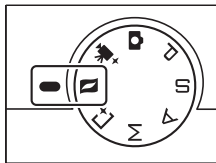

### 2 Frame the picture.

Compose the photograph with your subject in the center of the frame.



### 3 Begin buffering.

Press the shutter-release button half-way to focus ( 26). An icon will be displayed as the camera begins recording footage to the memory buffer.



### 4 Shoot.

Smoothly press the shutter-release button the rest of the way down. The camera will record a photograph, together with about 1.6 s of movie footage beginning before and ending after the time the shutter-release button was pressed all the way down. Note that some time may be required. When recording is complete, the photograph will be displayed for a few seconds.



#### Ending the Vignette with a Photograph

To make the photograph the same as the last frame in the movie vignette, select **1.6 s : 0 s** for **Movie before/after** ( 71).

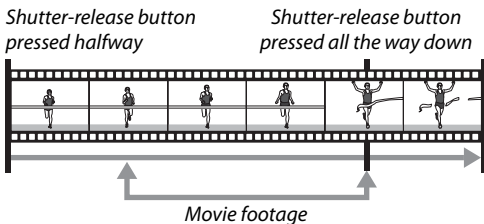

## ■ Choosing a Theme

To choose the background music for the movie, press **F** and use the command dial to select from **Beauty**, **Waves**, **Relaxation**, and **Tenderness**. Rotate the command dial to highlight an option and press the dial to select.

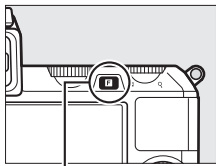

**F** button

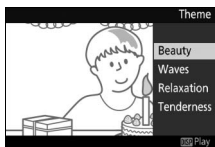

To play the background music for the highlighted theme, press the **DISP** button and use the command dial to adjust volume.

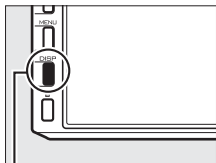





**DISP** button

## 📷 Motion Snapshot Mode

Live audio is not recorded. Movies can not be recorded using the movie-record button and the flash can not be used.

## Viewing Motion Snapshots

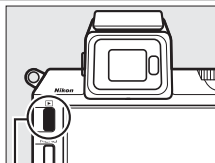

Press  and use the multi selector to display a Motion Snapshot ( 30; Motion Snapshots are indicated by a  icon). Pressing  when a Motion Snapshot is displayed plays back the movie portion in slow motion over a period of about 4 s, followed by the photo; the background track plays for about 10 s (to choose a new background track, use the **Change theme** option in the playback menu;  70). To end playback and return to shooting mode, press the shutter-release button halfway.



 button



## Deleting Motion Snapshots

To delete the current Motion Snapshot, press . A confirmation dialog will be displayed; press  again to delete the photo and movie and return to playback, or press  to exit without deleting the file. *Note that once deleted, Motion Snapshots can not be recovered.*

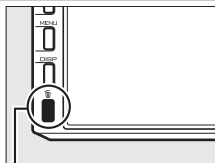

 button

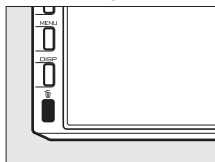

# More on Photography

## Single-Frame, Continuous, Self-Timer, and Remote Control Modes

Pressing ◀ (📷) on the multi selector displays a choice of shutter-release modes for still photography:

📷	<b>Single frame:</b> The camera takes pictures one at a time.
📷	<b>Continuous:</b> The camera takes photographs while the shutter-release button is pressed. The rate can be selected using the <b>Continuous</b> option in the shooting menu (📖 70).
🕒	<b>Self-timer:</b> Delayed shutter release (📖 62).
📷	<b>Remote control:</b> The shutter is using a remote control (📖 62).

### Continuous Mode

To take pictures in continuous mode:

#### 1 Display release mode options.

Press ◀ (📷) to display release mode options.



#### 2 Select 📷.

Highlight 📷 and press Ⓞ.

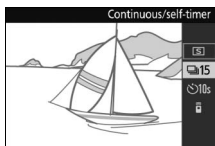

#### 3 Compose the shot and start shooting.

The camera takes pictures while the shutter-release button is held all the way down.



### **Continuous Mode**

The **Continuous** option in the shooting menu offers a choice of 5, 15, 30, and 60 fps (☞ 70). Frame rates of 15, 30, and 60 fps use an electronic shutter; except when **On** is selected for **Silent photography** (☞ 70), a mechanical shutter is used at a frame rate of 5 fps. The built-in flash can be used when **5 fps** is selected, but only one picture will be taken each time the shutter-release button is pressed; at settings of 15, 30, and 60 fps, the built-in flash will not fire. At 15 fps, the maximum number of shots that can be taken in a single burst is about 45, while at 30 and 60 fps the maximum is about 40.

While photographs are being recorded to the memory card, the memory card access lamp will light. Depending on shooting conditions and memory card write speed, recording may take up to about a minute. If the battery is exhausted before all photographs are recorded, the shutter release will be disabled and the remaining images transferred to the memory card.

Continuous shooting is not available in best moment capture, advanced movie, or Motion Snapshot mode, when live image control is used in auto mode (☞ 28), or when **On** is selected for **HDR** in the shooting menu (☞ 71).



## Self-Timer and Remote Control Modes

The self-timer and optional ML-L3 remote control (📖 79) can be used to reduce camera shake or for self-portraits.

### 🔍 Before Using the ML-L3 Remote Control

Before using the remote control for the first time, remove the clear plastic battery-insulator sheet.

### 1 Display release mode options.

Press ◀ (📷) to display release mode options.



### 2 Select the desired option.

Use the multi selector to highlight the desired option and press Ⓞ.

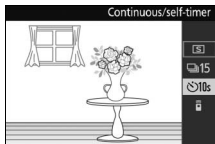

### 3 Mount the camera on a tripod.

Mount the camera on a tripod or place the camera on a stable, level surface.

### 4 Frame the photograph and shoot.

**Self-timer mode:** Press the shutter-release button halfway to focus, and then press the button the rest of the way down. The self-timer lamp will start to flash and a beep will begin to sound. Two seconds before the photo is taken, the lamp will stop flashing and the beeping will become more rapid.

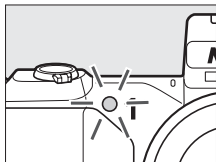



**Remote control mode:** From a distance of 5 m (16 ft) or less, aim the ML-L3 at the infrared receiver on the front of the camera (☞ 15) and press the ML-L3 shutter-release button. If **2 s delay** is selected for **Remote control** in the setup menu (☞ 72), the self-timer lamp will light for about two seconds before the shutter is released. If **Quick response** is selected, the self-timer lamp will flash after the shutter has been released.

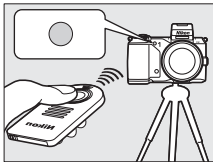

Note that the timer may not start or a photograph may not be taken if the camera is unable to focus or in other situations in which the shutter can not be released. Turning the camera off cancels self-timer and remote control modes. Remote control mode is cancelled automatically if no operations are performed for about ten minutes after the mode is selected in Step 2.



### **Movie Mode**

In self-timer mode, start and stop the timer by pressing the movie-record button instead of the shutter-release button. In remote control mode, the ML-L3 shutter-release button functions as the movie-record button for advanced movie mode (□ 47).

### **Using a Flash**

When using the built-in flash, press the  button to raise the flash before shooting. Shooting will be interrupted if the flash is raised while the self-timer or delayed-remote timer is counting down.



In remote control mode, the flash starts charging while the camera is waiting for the signal from the remote. The camera will only respond to the shutter-release button on the remote control when the flash is charged. If red-eye reduction (□ 65) is used when **Quick response** is selected for **Remote control** in the setup menu (□ 72), the shutter will be released about 1 second after the red-eye reduction lamp lights. If **2 s delay** is selected, there will be about a 2 second delay after the shutter-release button on the remote control is pressed; the red-eye reduction lamp will then light for about 1 second before the shutter is released.

### **See Also**

For information on choosing how long the camera will wait for a signal from the remote, see page 72. See page 72 for information on choosing the shutter-release delay in self-timer mode.







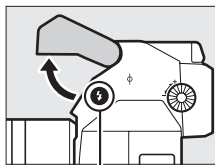

## The Built-in Flash

To use the flash, raise it by pressing the  button. Charging begins when the flash is raised; once charging is complete, a flash-ready indicator () will be displayed when the shutter-release button is pressed halfway. The following flash modes are available; choose a flash mode as described on the following page.



 button

	<b>Fill flash:</b> The flash fires with every shot. Use when the subject is poorly lit or with back-lit subjects to “fill in” (illuminate) shadows.
	<b>Red-eye reduction:</b> The red-eye reduction lamp lights before the flash fires, reducing “red-eye” caused by light reflecting from your subject’s retinas.
	<b>Red-eye reduction + slow sync:</b> Combines red-eye reduction with slow shutter speeds to capture background details at night or under low light. Use for portraits taken against a backdrop of night scenery.
	<b>Fill flash + slow sync:</b> Combines fill flash with slow shutter speeds to capture details of poorly-lit backgrounds.
	<b>Rear curtain + slow sync:</b> Combines rear-curtain sync (see below) with slow shutter speeds to capture poorly-lit background details.
	<b>Rear-curtain sync:</b> While in other modes the flash fires as the shutter opens, in rear-curtain sync the flash fires just before the shutter closes, creating streams of light that appear to follow moving light sources.

### Lowering the Built-in Flash

To save power when the flash is not in use, press it gently downward until the latch clicks into place. *Do not use force.* Failure to observe this precaution could result in product malfunction.

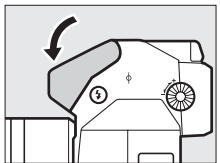

## Choosing a Flash Mode

### 1 Display the flash mode options.

Press  $\blacktriangledown$  ( $\text{⚡}$ ) to display a list of flash modes. The modes available vary with the shooting mode (📖 19).



Auto mode	P, A
$\text{⚡}$ Fill flash	$\text{⚡}$ Fill flash
$\text{⚡}$ $\text{👁}$ Red-eye reduction	$\text{⚡}$ $\text{👁}$ Red-eye reduction
	$\text{⚡}$ $\text{👁}$ SLOW Red-eye reduction + slow sync
S, M	$\text{⚡}$ SLOW Fill flash + slow sync
$\text{⚡}$ Fill flash	$\text{⚡}$ SLOW REAR Rear curtain + slow sync
$\text{⚡}$ $\text{👁}$ Red-eye reduction	
$\text{⚡}$ REAR Rear-curtain sync	

### 2 Select a flash mode.

Use the multi selector to highlight a flash mode (📖 65) and press  $\text{OK}$  to select.

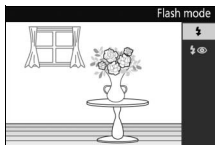

### Using the Built-in Flash

The built-in flash can be used in auto and P, S, A, and M modes only; note, however, that the flash can not be used with live image control (□ 28) and will not fire when **On** is selected for **HDR** in the shooting menu (□ 71), or in □ mode (□ 60) when a frame rate of 15, 30, or 60 fps is selected for **Continuous** in the shooting menu (□ 70). If the flash is fired multiple times in quick succession, the flash and shutter may be temporarily disabled to protect the flash. Shooting can be resumed after a brief pause.

Objects close to the camera may be overexposed in photographs taken with the flash at high ISO sensitivities.

To avoid vignetting, remove lens hoods and shoot at ranges of at least 0.6 m (2 ft). Some lenses may cause vignetting at greater distances or obstruct the red-eye reduction lamp, interfering with red-eye reduction. The following illustrations show the effect of vignetting caused by shadows cast by the lens when the built-in flash is used.

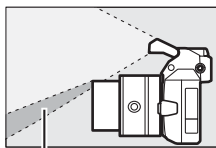

*Shadow*

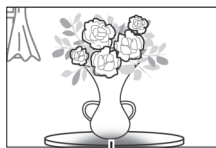

*Shadow*

### Aperture, Sensitivity, and Flash Range

Flash range varies with sensitivity (ISO equivalency) and aperture. With the standard zoom lens at maximum aperture and ISO sensitivity set to ISO 160 to 6400, the range is approximately 0.6 m–7.0 m (2 ft–23 ft) when the lens is zoomed all the way out, 0.6 m–4.2 m (2 ft–13.8 ft) at maximum zoom.



# Menu Guide

Most shooting, playback, and setup options can be accessed from the camera menus. To view the menus, press the MENU button.

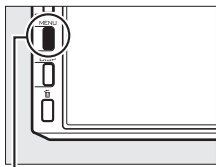

MENU button

## Tabs

Choose from the following menus:

▶ Playback menu (70)

⚙ Setup menu (72)

📷 P S A M ⏪ ⏩ ⚡ Shooting menu (70)

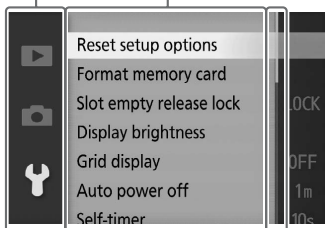

Menu options  
Options in current menu.

Slider shows position in current menu.

## ■ Using the Menus

Use the multi selector to navigate the menus.

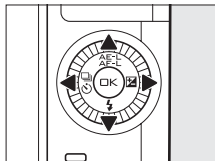

Multi selector

### 1 Select a menu.

Press ▲ or ▼ to highlight tabs and press ► to position the cursor in the highlighted menu.

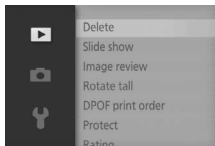

### 2 Select an item.

Press ▲ or ▼ to highlight menu items and press ► to view options for the highlighted item.

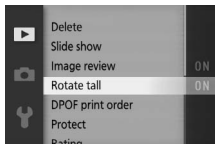

### 3 Select an option.

Press ▲ or ▼ to highlight the desired option and press  to select.

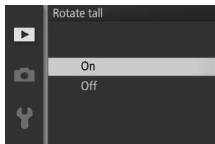

### Using the Menus

The items listed may vary with camera settings. Items displayed in gray are not currently available. To exit the menus and return to shooting mode, press the shutter-release button halfway ( 26).

## ■ Playback Menu Options

Option	Description
Delete	Delete multiple images.
Slide show	View movies and photos in a slide show.
Image review	Choose whether pictures are displayed after shooting.
Rotate tall	Rotate "tall" (portrait-orientation) pictures for display during playback.
DPOF print order	Create digital "print orders".
Protect	Protect pictures from accidental deletion.
Rating	Rate pictures.
D-Lighting	Brighten shadows in dark or back-lit photos, creating a retouched copy that is saved separately from the unmodified original.
Resize	Create small copies of selected pictures.
Crop	Create cropped copies of selected pictures.
Edit movie	Create copies of movies from which unwanted footage has been trimmed.
Change theme	Change the themes for existing Motion Snapshots.

## ■ Shooting Menu Options

Option	Description
Reset shooting options	Reset shooting options to default values.
Exposure mode	Choose how the camera sets shutter speed and aperture.
Image quality	Choose a file format and compression ratio.
Image size	Choose a size for new photos.
Continuous	Choose the frame rate for continuous shooting (□ 60).
Silent photography	Choose whether to mute shutter and control sounds.
Number of shots saved	Choose the number of shots selected by the Smart Photo Selector (□ 43).



<b>Option</b>	<b>Description</b>
<b>Frame rate</b>	Choose a frame rate for slow-motion movies (☐ 51).
<b>Movie settings</b>	Choose HD movie frame size and frame rate (☐ 47).
<b>Movie before/after</b>	Choose when the movie portion of Motion Snapshots is recorded (☐ 56).
<b>File format</b>	Choose a file format for new Motion Snapshots (☐ 56).
<b>Metering</b>	Choose how the camera meters exposure.
<b>White balance</b>	Adjust settings for different types of lighting.
<b>ISO sensitivity</b>	Control the camera's sensitivity to light.
<b>Picture Control</b>	Choose how the camera processes pictures.
<b>Custom Picture Control</b>	Create custom Picture Controls.
<b>Auto distortion control</b>	Choose whether the camera corrects barrel and pin-cushion distortion.
<b>Color space</b>	Choose a color space for new pictures.
<b>Active D-Lighting</b>	Avoid loss of detail in highlights and shadows.
<b>HDR</b>	Enhance detail in highlights and shadows when photographing high-contrast scenes.
<b>Long exposure NR</b>	Reduce noise in long time-exposures.
<b>High ISO noise reduction</b>	Reduce noise at high ISO sensitivities.
<b>Movie sound options</b>	Choose sound recording options.
<b>Vibration reduction</b>	Adjust settings for 1 NIKKOR lenses with vibration reduction.
<b>Focus mode</b>	Choose how the camera focuses.
<b>AF-area mode</b>	Choose how the focus area is selected.
<b>Face-priority</b>	Turn face priority on or off.
<b>Built-in AF assist</b>	Control the built-in AF-assist illuminator.
<b>Flash control</b>	Choose a flash mode for the built-in flash and optional flash units.
<b>Flash compensation</b>	Control flash output.



## ■ Setup Menu Options

Option	Description
<b>Reset setup options</b>	Reset setup menu options to default values.
<b>Format memory card</b>	Format the memory card.
<b>Slot empty release lock</b>	Allow the shutter to be released when no memory card is inserted in the camera.
<b>Display brightness</b>	Adjust display brightness.
<b>Grid display</b>	Display a framing grid.
<b>Auto power off</b>	Choose the auto power off delay.
<b>Self-timer</b>	Choose the self-timer delay.
<b>Remote control</b>	Choose the remote control mode shutter-release delay.
<b>Remote on duration</b>	Choose how long the camera waits for a signal from an ML-L3 remote control.
<b>Assign AE/AF-L button</b>	Choose the role played by the ▲ (AE-L) button.
<b>Shutter button AE lock</b>	Choose whether exposure locks when the shutter-release button is pressed halfway.
<b>HDMI device control</b>	Choose whether remote controls for HDMI-CEC devices to which the camera is connected can be used to operate the camera.
<b>Flicker reduction</b>	Reduce flicker or banding.
<b>Reset file numbering</b>	Reset file numbering.
<b>Time zone and date</b>	Set the camera clock.
<b>Language</b>	Choose a language for the camera displays.
<b>Auto image rotation</b>	Record camera orientation with pictures.
<b>Wireless mobile adapter</b>	Enable or disable the wireless mobile adapter.
<b>GPS</b>	Adjust settings for optional GPS units.
<b>Pixel mapping</b>	Check and optimize the camera image sensor and image processors.
<b>Firmware version</b>	Display the current firmware version.





# Connecting to a Computer

## Installing the Supplied Software

Install the supplied software to copy pictures to your computer for viewing and editing pictures and creating short movies. Before installing the software, confirm that your system meets the requirements on page 74.

---

### 1 Insert the installer CD.

Start the computer and insert the ViewNX 2/Short Movie Creator CD. In Windows, the installer "Welcome" dialog will launch automatically; proceed to Step 2. Users of Mac OS must first double-click the CD icon (  ) on the desktop and then double-click the **Welcome** icon (  ).

---

### 2 Select a language.

Select a language and click **Next**. If the desired language is not available, click **Region Selection** to choose a different region and then choose the desired language (region selection is not available in the European release).

---

### 3 Start the installer.

Click **Install** and follow the on-screen instructions.

---

### 4 Exit the installer.

Click **Yes** (Windows) or **OK** (Mac OS) when installation is complete. The following software is installed:

- ViewNX 2
- Short Movie Creator
- Apple QuickTime (Windows only)

---

### 5 Remove the installer CD from the CD-ROM drive.

#### Supplied Software

Be sure to update to the latest versions of the supplied software. Nikon Message Center 2 will periodically check for updates while the computer is connected to the Internet.



## System Requirements

The system requirements for ViewNX 2 are:

Windows	
<b>CPU</b>	<ul style="list-style-type: none"><li>• <b>Photos/JPEG movies:</b> Intel Celeron, Pentium 4, or Core series, 1.6 GHz or better</li><li>• <b>H.264 movies (playback):</b> 3.0 GHz Pentium D or better</li><li>• <b>H.264 movies (editing):</b> 2.6 GHz Core 2 Duo or better</li></ul>
<b>OS</b>	Pre-installed versions of Windows 7 Home Basic/Home Premium/Professional/Enterprise/Ultimate (64- and 32-bit editions; Service Pack 1), Windows Vista Home Basic/Home Premium/Business/Enterprise/Ultimate (64- and 32-bit editions; Service Pack 2), or Windows XP Home Edition/Professional (32-bit editions only; Service Pack 3)
<b>RAM</b>	<ul style="list-style-type: none"><li>• <b>Windows 7/Windows Vista:</b> 1 GB or more (2 GB or more recommended)</li><li>• <b>Windows XP:</b> 512 MB or more (2 GB or more recommended)</li></ul>
<b>Hard-disk space</b>	A minimum of 500 MB available on the startup disk (1 GB or more recommended)
<b>Monitor</b>	<ul style="list-style-type: none"><li>• <b>Resolution:</b> 1024 × 768 pixels (XGA) or more (1280 × 1024 pixels/SXGA or more recommended)</li><li>• <b>Color:</b> 24-bit color (True Color) or more</li></ul>

Mac OS	
<b>CPU</b>	<ul style="list-style-type: none"><li>• <b>Photos/JPEG movies:</b> Intel Core or Xeon series</li><li>• <b>H.264 movies (playback):</b> 2 GHz Core Duo or better</li><li>• <b>H.264 movies (editing):</b> 2.6 GHz Core 2 Duo or better</li></ul>
<b>OS</b>	Mac OS X version 10.6.8, 10.7.5, or 10.8.2
<b>RAM</b>	512 MB or more (2 GB or more recommended)
<b>Hard-disk space</b>	A minimum of 500 MB available on the startup disk (1 GB or more recommended)
<b>Monitor</b>	<ul style="list-style-type: none"><li>• <b>Resolution:</b> 1024 × 768 pixels (XGA) or more (1280 × 1024 pixels/SXGA or more recommended)</li><li>• <b>Color:</b> 24-bit color (millions of colors) or more</li></ul>

### Motion Snapshots

ViewNX 2 is required to view Motion Snapshots saved using the **File format > NMS files** option in the shooting menu (☐ 71).

### Supported Operating Systems

See the websites listed on page 13 for the latest information on supported operating systems.

# Viewing and Editing Pictures on a Computer

## Transferring Pictures

### 1 Choose how pictures will be copied to the computer.

Choose one of the following methods:

- **Direct USB connection:** Turn the camera off and ensure that the memory card is inserted in the camera. Connect the camera to the computer using the supplied USB cable (do not use force or insert the connectors at an angle) and then turn the camera on.

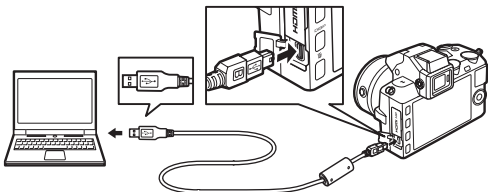

- **SD card slot:** If your computer is equipped with an SD card slot, the card can be inserted directly in the slot.
- **SD card reader:** Connect a card reader (available separately from third-party suppliers) to the computer and insert the memory card.

### 2 Start the Nikon Transfer 2 component of ViewNX 2.

If a message is displayed prompting you to choose a program, select Nikon Transfer 2.

#### Windows 7

If the following dialog is displayed, select Nikon Transfer 2 as described below.

- 1 Under **Import pictures and videos**, click **Change program**. A program selection dialog will be displayed; select **Import File using Nikon Transfer 2** and click **OK**.



- 2 Double-click **Import file**.



### 3 Click Start Transfer.

At default settings, all the pictures on the memory card will be copied to the computer.



Click **Start Transfer**

### 4 Terminate the connection.

If the camera is connected to the computer, turn the camera off and disconnect the USB cable. If you are using a card reader or card slot, choose the appropriate option in the computer operating system to eject the removable disk corresponding to the memory card and then remove the card from the card reader or card slot.

## Viewing Pictures

Pictures are displayed in ViewNX 2 when transfer is complete.

#### Starting ViewNX 2 Manually

- **Windows:** Double-click the ViewNX 2 shortcut on the desktop.
- **Mac OS:** Click the ViewNX 2 icon in the Dock.

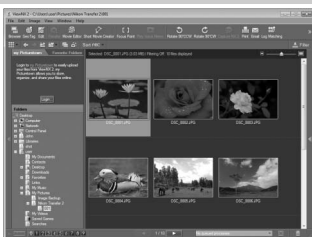

## ■ ■ Retouching Photographs

To crop pictures and perform such tasks as adjusting sharpness and tone levels, click the **Edit** button in the toolbar.



## ■ ■ Printing Pictures

Click the **Print** button in the toolbar. A dialog will be displayed, allowing you to print pictures on a printer connected to the computer.



### For More Information

Consult online help for more information on using ViewNX 2.

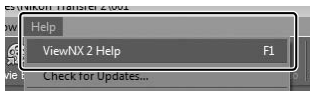

# Technical Notes

Read this chapter for information on compatible accessories, cleaning and storing the camera, and what to do if an error message is displayed or you encounter problems using the camera.

## Optional Accessories

At the time of writing, the following accessories were available for your camera.

<b>Lenses</b>	<b>1 mount lenses</b>
<b>Mount adapters</b>	<b>Mount Adapter FT1</b>
<b>Power sources</b>	<ul style="list-style-type: none"><li>• <b>Rechargeable Li-ion Battery EN-EL21</b> (☐ 20–21): Additional EN-EL21 batteries are available from local retailers and Nikon-authorized service representatives.</li><li>• <b>Battery Charger MH-28</b> (☐ 20): Recharge EN-EL21 batteries.</li><li>• <b>Power Connector EP-5D, AC Adapter EH-5b</b>: These accessories can be used to power the camera for extended periods (EH-5a and EH-5 AC adapters can also be used). An EP-5D power connector is required to connect the camera to the EH-5b, EH-5a, or EH-5.</li></ul>
<b>Flash units</b>	<ul style="list-style-type: none"><li>• <b>SB-N5</b>: The SB-N5 has a Guide Number of 8.5/27.9 (m/ft, ISO 100, 20 °C/68 °F; Guide Number at ISO 160 is 10.8/35.4). When mounted on the Nikon 1 V2, it supports i-TTL and manual flash control.</li><li>• <b>SB-N7</b>: The SB-N7 has a Guide Number of 18/59 (m/ft, ISO 100, 20 °C/68 °F; Guide Number at ISO 160 is 22.8/74.8). When mounted on the Nikon 1 V2, it supports i-TTL and manual flash control.</li></ul> <div style="border: 1px solid black; padding: 5px;"><p><b>☑ Guide Number</b></p><p>To calculate the range of the flash at full power, divide the Guide Number by the aperture. For example, at ISO 100 the SB-N5 has a Guide Number of 8.5 m or 27.9 ft (35 mm zoom head position); its range at an aperture of f/5.6 is <math>8.5 \div 5.6</math> or about 1.5 meters (or in feet, <math>27.9 \div 5.6 =</math> approximately 5 ft). For each twofold increase in ISO sensitivity, multiply the Guide Number by the square root of two (approximately 1.4).</p></div>

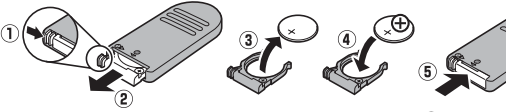

<b>Remote controls</b>	<p><b>Wireless Remote Control ML-L3</b> (☐ 62): The ML-L3 uses a 3 V CR2025 battery.</p>  <p>Pressing the battery-chamber latch to the right (①), insert a fingernail into the gap and open the battery chamber (②). Ensure that the battery is in the correct orientation (④).</p>
<b>Body caps</b>	<p><b>Body Cap BF-N1000</b>: The body cap keeps the image sensor free of dust when a lens is not in place.</p>
<b>Micro-phones</b>	<p><b>Stereo Microphone ME-1</b>: Connect the ME-1 to the camera microphone jack to record stereo sound while reducing the noise caused by lens vibration being recorded during autofocus.</p>
<b>GPS units</b>	<p><b>GP-N100</b>: Record the time (UTC) and the camera's current latitude, longitude, and altitude with every picture taken.</p>
<b>Wireless mobile adapters</b>	<p><b>WU-1b</b>: Create a wireless connection that can be used by smart devices running the Wireless Mobile Adapter Utility to download pictures or control the camera remotely.</p>



## Approved Memory Cards

The following cards have been tested and approved for use in the camera. Cards with class 6 or faster write speeds are recommended for movie recording. Recording may end unexpectedly when cards with slower write speeds are used.

	SD cards	SDHC cards <sup>2</sup>	SDXC cards <sup>3</sup>
<b>SanDisk</b>	2 GB <sup>1</sup>	4 GB, 8 GB, 16 GB, 32 GB	64 GB
<b>Toshiba</b>			
<b>Panasonic</b>			48 GB, 64 GB
<b>Lexar Media</b>	—	4 GB, 8 GB, 16 GB	—
<b>Platinum II</b>		4 GB, 8 GB, 16 GB, 32 GB	
<b>Professional</b>		4 GB, 8 GB, 16 GB	
<b>Full-HD Video</b>		4 GB, 8 GB, 16 GB	

- 1 Check that any card readers or other devices with which the card will be used support 2 GB cards.
- 2 Check that any card readers or other devices with which the card will be used are SDHC-compliant. The camera supports UHS-1.
- 3 Check that any card readers or other devices with which the card will be used are SDXC-compliant.  The camera supports UHS-1.

Other cards have not been tested. For more details on the above cards, please contact the manufacturer.



## Storage and Cleaning

### Storage

If the camera will not be used for an extended period, remove the battery and store it in a cool, dry area with the terminal cover in place. To prevent mold or mildew, store the camera in a dry, well-ventilated area. Do not store your camera with naphtha or camphor moth balls or in locations that:

- are poorly ventilated or subject to humidities of over 60%
- are next to equipment that produces strong electromagnetic fields, such as televisions or radios
- are exposed to temperatures above 50 °C (122 °F) or below -10 °C (14 °F)

### Cleaning

<b>Camera body</b>	Use a blower to remove dust and lint, then wipe gently with a soft, dry cloth. After using the camera at the beach or sea-side, wipe off sand or salt with a cloth lightly dampened in distilled water and dry thoroughly. <b>Important:</b> <i>Dust or other foreign matter inside the camera may cause damage not covered under warranty.</i>
<b>Lens, viewfinder</b>	These elements are easily damaged. Remove dust and lint with a blower. If using an aerosol blower, keep the can vertical to prevent the discharge of liquid. To remove fingerprints and other stains, apply a small amount of lens cleaner to a soft cloth and clean with care.
<b>Monitor</b>	Remove dust and lint with a blower. When removing fingerprints and other stains, wipe the surface lightly with a soft cloth or chamois leather. Do not apply pressure, as this could result in damage or malfunction.

*Do not use alcohol, thinner, or other volatile chemicals.*



## Caring for the Camera and Battery: Cautions

**Do not drop:** The product may malfunction if subjected to strong shocks or vibration. Physical shocks may also cause the shutter to malfunction.

**Keep dry:** This product is not waterproof, and may malfunction if immersed in water or exposed to high levels of humidity. Rusting of the internal mechanism can cause irreparable damage.

**Avoid sudden changes in temperature:** Sudden changes in temperature, such as those that occur when entering or leaving a heated building on a cold day, can cause condensation inside the device. To prevent condensation, place the device in a carrying case or plastic bag before exposing it to sudden changes in temperature.

**Keep away from strong magnetic fields:** Do not use or store this device in the vicinity of equipment that generates strong electromagnetic radiation or magnetic fields. Strong static charges or the magnetic fields produced by equipment such as radio transmitters could interfere with the displays, damage data stored on the memory card, or affect the product's internal circuitry.

**Keep the lens mount covered:** Be sure to attach the body cap if the camera is without a lens.

**Do not touch the image sensor:** The image sensor is easily damaged. Under no circumstances should you exert pressure on the sensor, poke it with cleaning tools, or subject it to powerful air currents from a blower. These actions could scratch or otherwise damage the sensor.

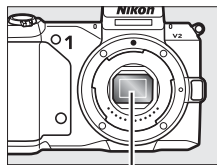

*Image sensor*

**Turn the product off before removing or disconnecting the power source:** Do not unplug the product or remove the battery while the product is on or while images are being recorded or deleted. Forcibly cutting power in these circumstances could result in loss of data or in damage to product memory or internal circuitry. To prevent an accidental interruption of power, avoid carrying the product from one location to another while the AC adapter is connected.

**Cleaning:** When cleaning the camera body, use a blower to gently remove dust and lint, then wipe gently with a soft, dry cloth. After using the camera at the beach or seaside, wipe off any sand or salt using a cloth lightly dampened in pure water and then dry the camera thoroughly.

The lens is easily damaged. Dust and lint should be gently removed with a blower. When using an aerosol blower, keep the can vertical to prevent discharge of liquid. To remove fingerprints and other stains from the lens, apply a small amount of lens cleaner to a soft cloth and wipe the lens carefully.

**Storage:** To prevent mold or mildew, store the camera in a dry, well-ventilated area. If you are using an AC adapter, unplug the adapter to prevent fire. If the product will not be used for an extended period, remove the battery to prevent leakage and store the camera in a plastic bag containing a desiccant. Do not, however, store the camera case in a plastic bag, as this may cause the material to deteriorate. Note that desiccant gradually loses its capacity to absorb moisture and should be replaced at regular intervals.

To prevent mold or mildew, take the camera out of storage at least once a month. Turn the camera on and release the shutter a few times before putting it away.

Store the battery in a cool, dry place. Replace the terminal cover before putting the battery away.

**Notes on the monitor and viewfinder:** These displays are constructed with extremely high precision; at least 99.99% of pixels are effective, with no more than 0.01% being missing or defective. Hence while these displays may contain pixels that are always lit (white, red, blue, or green) or always off (black), this is not a malfunction and has no effect on images recorded with the device.

Images in the monitor may be difficult to see in a bright light.

Do not apply pressure to the displays, as this could cause damage or malfunction. Dust or lint on the displays can be removed with a blower. Stains can be removed by wiping lightly with a soft cloth or chamois leather. Should the monitor or viewfinder break, care should be taken to avoid injury from broken glass and to prevent liquid crystal from the display touching the skin or entering the eyes and mouth.



**Do not leave the lens pointed at the sun:** Do not leave the lens pointed at the sun or other strong light source for an extended period. Intense light may cause the image sensor to deteriorate or produce a white blur effect in photographs.

**Moiré:** Moiré is an interference pattern created by the interaction of an image containing a regular, repeating grid, such as the pattern of weave in cloth or windows in a building, with the camera image sensor grid. In some cases, it may appear in the form of lines. If you notice moiré in your photographs, try changing the distance to the subject, zooming in and out, or changing the angle between the subject and the camera.

**Lines:** Noise in the form of lines may in rare cases appear in pictures of extremely bright or backlit subjects.

**Batteries:** Batteries may leak or explode if improperly handled. Observe the following precautions when handling batteries:

- Use only batteries approved for use in this equipment.
- Do not expose the battery to flame or excessive heat.
- Keep the battery terminals clean.
- Turn the product off before replacing the battery.
- Remove the battery from the camera or charger when not in use and replace the terminal cover. These devices draw minute amounts of charge even when off and could draw the battery down to the point that it will no longer function. If the battery will not be used for some time, insert it in the camera and run it flat before removing it and storing it in a location with an ambient temperature of 15 °C to 25 °C (59 °F to 77 °F; avoid hot or extremely cold locations). Repeat this process at least once every six months.
- Turning the camera on and off repeatedly when the battery is fully discharged will shorten battery life. Batteries that have been fully discharged must be charged before use.
- The internal temperature of the battery may rise while the battery is in use. Attempting to charge the battery while the internal temperature is elevated will impair battery performance, and the battery may not charge or charge only partially. Wait for the battery to cool before charging.
- Continuing to charge the battery after it is fully charged can impair battery performance.



- A marked drop in the time a fully charged battery retains its charge when used at room temperature indicates that it requires replacement. Purchase a new EN-EL21 battery.
- Charge the battery before use. When taking photographs on important occasions, ready a spare EN-EL21 battery and keep it fully charged. Depending on your location, it may be difficult to purchase replacement batteries on short notice. Note that on cold days, the capacity of batteries tends to decrease. Be sure the battery is fully charged before taking photographs outside in cold weather. Keep a spare battery in a warm place and exchange the two as necessary. Once warmed, a cold battery may recover some of its charge.
- Used batteries are a valuable resource; recycle in accord with local regulations.

#### **Image Sensor Cleaning**

Each time it is turned on or off, the camera performs image sensor cleaning to remove dust from the image sensor (note that operating camera controls before cleaning is complete interrupts this process, and that image sensor cleaning may be temporarily disabled if the camera is turned on and off several times in succession). Dust not removed by this method may appear in images recorded with the camera, in which case you should have the sensor cleaned by Nikon-authorized service personnel.

#### **Servicing the Camera and Accessories**

The camera is a precision device and requires regular servicing. Nikon recommends that the camera be inspected by the original retailer or Nikon-authorized service representative once every one to two years, and that it be serviced once every three to five years (note that fees apply to these services). Frequent inspection and servicing are particularly recommended if the camera is used professionally. Any accessories regularly used with the camera, such as lenses or optional flash units, should be included when the camera is inspected or serviced.



## Troubleshooting

If the camera fails to function as expected, check this list of common problems before consulting your retailer or Nikon representative.

### **Battery/Display**

---

**The camera is on but does not respond:** Wait for recording or any other processing to end. If the problem persists, turn the camera off. If the camera still does not respond, remove and replace the battery or disconnect and reconnect the AC adapter, but note that this will delete any data not yet saved. Data already saved to the memory card are unaffected.

---

**The displays are off:**

- The camera is off (☐ 22) or the battery is exhausted (☐ 17, 20).
  - The monitor has been turned off. Press the DISP button to turn the monitor on.
  - An object has come close to the eye sensor, turning the viewfinder on and the monitor off (☐ 18).
  - The displays have turned off automatically to save power. The displays can be reactivated by operating buttons or the mode dial.
  - The camera is connected to a computer (☐ 75) or television.
- 

**The displays turn off without warning:**

- The battery is low (☐ 17, 20).
  - The displays have turned off automatically to save power. The displays can be reactivated by operating buttons or the mode dial.
  - The camera's internal temperature is high (☐ 12, 90). Wait for the camera to cool before turning it on again.
- 

**The viewfinder is out of focus:** Focus the viewfinder using the diopter adjustment control (☐ 18).

---

**Indicators are not displayed:** Press the DISP button (☐ 23).

---





## Shooting (All Modes)

---

**The camera takes time to turn on:** Delete files or format the memory card.

---

**The shutter-release is disabled:**

- The battery is exhausted (☐ 17, 20).
  - The memory card is locked or full.
  - The flash is charging (☐ 65).
  - The camera is not in focus (☐ 26).
  - You are currently filming a slow motion movie (☐ 49).
- 

**Only one picture is taken each time the shutter-release button is pressed in continuous release mode:** 5 fps is selected for **Continuous** and the built-in flash is raised.

---

**No photo taken when ML-L3 remote control shutter-release button is pressed:**

- Replace battery in remote control (☐ 79).
  - Choose a remote control mode (☐ 60).
  - The remote control standby timer has expired (☐ 72).
  - The remote is not pointed at the camera or the infrared receiver is not visible (☐ 15, 63).
  - The remote is too far from the camera (☐ 63).
  - Bright light is interfering with remote.
- 

**Smudges appear in photographs:** Clean the front and rear lens elements.

---

**Flicker or banding appears in movies or in the displays:** Choose a **Flicker reduction** setting that matches the local AC power supply (☐ 72).

---

**No flash:** The camera is in best moment capture or Motion Snapshot mode or is recording a movie, or ☐ is selected for **Continuous/self-timer** (☐ 60) and the **Continuous** is 15 fps or above (☐ 70).

---

**Menu items are unavailable:** Some options are only available in particular shooting or exposure modes or when the built-in flash is raised (☐ 65) or a flash, GPS unit, or wireless mobile adapter is attached.

---

## Movies

---

**Cannot record movies:** The movie-record button can not be used to record movies in best moment capture or Motion Snapshot mode (☐ 46, 58).

---

**No sound is recorded for movies:**

- **Microphone off** is selected for **Movie sound options > Microphone** (☐ 71).
- Live audio is not recorded with slow-motion movies (☐ 51) or Motion Snapshots (☐ 56).



## **Playback**

---

**“Tall” (portrait) orientation photos are displayed in “wide” (landscape) orientation:**

- Select **On** for **Rotate tall** (☐ 70).
- The photos were taken with **Auto image rotation** off.
- Camera was pointed up or down when the photo was taken.
- Photo is displayed in image review.

**Cannot hear movie sound:**

- Rotate the command dial right to raise the volume (☐ 54). If the camera is connected to a television, use the controls for the TV to adjust the volume.
- Live audio is not recorded with slow-motion movies (☐ 51) or Motion Snapshots (☐ 58).

**Cannot delete images:**

- Remove protection from the files before deletion.
- The memory card is locked.

## **Miscellaneous**

---

**The date of recording is not correct:** Set the camera clock.

**Menu items are unavailable:** Some options are only available at particular settings or when a memory card is inserted.



## Error Messages

This section lists the error messages that appear in the display.

Message	Solution
(Shutter-speed or aperture display flashes)	If the subject is too bright, lower ISO sensitivity or choose a faster shutter speed or smaller aperture (higher f-number). If the subject is too dark, raise ISO sensitivity, use a flash, or choose a slower shutter speed or larger aperture (lower f-number).
Keeping the zoom ring button pressed, rotate the zoom ring to extend the lens.	A lens with a retractable lens barrel button is attached with the lens barrel retracted. Press the retractable lens barrel button and rotate the zoom ring to extend the lens.
Check lens. Pictures can only be taken when a lens is attached.	Attach a lens.
Start-up error. Turn the camera off and then on again.	Turn the camera off, remove and replace the battery, and then turn the camera on.
The clock has been reset.	Set the camera clock.
No memory card.	Turn the camera off and confirm that the card is correctly inserted.
This memory card is not formatted. Format the memory card?	Select <b>Yes</b> to format the card, or turn the camera off and insert another memory card.
Memory card is locked (write protected).	Turn the camera off and slide the card write-protect switch to the "write" position.
Memory card is full.	<ul style="list-style-type: none"><li>• You may be able to record additional images if you reduce image quality or size.</li><li>• Delete unwanted images.</li><li>• Insert another memory card.</li></ul>
This memory card cannot be used. Card may be damaged; insert a different card.	<ul style="list-style-type: none"><li>• Use an approved card.</li><li>• Format the card. If the problem persists, the card may be damaged. Contact a Nikon-authorized service representative.</li><li>• Insert a new memory card.</li></ul>



Message	Solution
Cannot create additional folders on memory card.	If the current folder is numbered 999 and contains either 999 photographs or a photograph numbered 9999, the shutter-release button will be disabled and no further photographs can be taken. Choose <b>Yes</b> for <b>Reset file numbering</b> and then either format the current memory card or insert a new memory card.
The movie-record button cannot be used in this mode.	The movie-record button can not be used in best moment capture or Motion Snapshot modes.
Photographs cannot be recorded in this mode.	The shutter-release button can not be used to take photographs while a slow-motion movie is being recorded.
The camera's internal temperature is high. The camera will now turn off.	Wait for the camera to cool.
Memory card contains no images.	To view pictures, insert a memory card containing images.
Cannot display this file.	The file has been created or modified on a computer or different make of camera, or is corrupt.











## Specifications

### Nikon 1 V2 Digital Camera

<b>Type</b>	
Type	Digital camera with support for interchangeable lenses
Lens mount	Nikon 1 mount
Effective angle of view	Approx. 2.7× lens focal length (35 mm format equivalent)
Effective pixels	14.2 million
<b>Image sensor</b>	
Image sensor	13.2 mm × 8.8 mm CMOS sensor (Nikon CX format)
Dust-reduction system	Image sensor cleaning
<b>Storage</b>	
Image size (pixels)	<b>Still images (📷, P, S, A, M, ⏏ modes; aspect ratio 3 : 2)</b>
	• 4608 × 3072
	• 2304 × 1536
	• 3456 × 2304
Image size (pixels)	<b>Still images (📷+ mode; aspect ratio 3 : 2)</b>
	• 4608 × 3072 (1080/60i, 1080/30p)
	• 1280 × 856 (720/60p, 720/30p)
Image size (pixels)	<b>Still images (Motion Snapshots; aspect ratio 16 : 9)</b>
	4608 × 2592
File format	<ul style="list-style-type: none"> <li>• <b>NEF (RAW):</b> 12-bit, compressed</li> <li>• <b>JPEG:</b> JPEG-Baseline compliant with fine (approx. 1 : 4), normal (approx. 1 : 8), or basic (approx. 1 : 16) compression</li> <li>• <b>NEF (RAW) + JPEG:</b> Single photograph recorded in both NEF (RAW) and JPEG formats</li> </ul>
Picture Control system	Standard, Neutral, Vivid, Monochrome, Portrait, Landscape; selected Picture Control can be modified; storage for custom Picture Controls
Media	SD (Secure Digital), SDHC, and SDXC memory cards
File system	DCF (Design Rule for Camera File System) 2.0, DPOF (Digital Print Order Format), Exif (Exchangeable Image File Format for Digital Still Cameras) 2.3, PictBridge





Electronic viewfinder	
Electronic viewfinder	0.47-in., approx. 1440k-dot color TFT LCD viewfinder with diopter control and brightness adjustment
Frame coverage	Approx. 100% horizontal and 100% vertical
Eyepoint	18 mm ( $-1.0 \text{ m}^{-1}$ ; from center surface of viewfinder eyepiece lens)
Diopter adjustment	$-3$ – $+2 \text{ m}^{-1}$
Eye sensor	Camera switches to viewfinder display when it detects that viewfinder is in use

Shooting modes	 auto,  programmed auto,  shutter-priority auto,  aperture-priority auto,  manual,  best moment capture (slow view and Smart Photo Selector),  advanced movie (HD and slow motion),  Motion Snapshot
----------------	--

Shutter	
Type	Electronically-controlled vertical-travel focal-plane mechanical shutter; electronic shutter
Speed	<ul style="list-style-type: none"> <li>• <b>Mechanical shutter:</b> <math>\frac{1}{4000}</math>–30 s in steps of <math>\frac{1}{3}</math> EV; Bulb; Time (requires optional ML-L3 remote control)</li> <li>• <b>Electronic shutter:</b> <math>\frac{1}{6,000}</math>–30 s in steps of <math>\frac{1}{3}</math> EV; Bulb; Time (requires optional ML-L3 remote control)</li> </ul> <b>Note:</b> Bulb and Time end automatically after approximately 2 minutes
Flash sync speed	<ul style="list-style-type: none"> <li>• <b>Mechanical shutter:</b> Synchronizes with shutter at <math>X=\frac{1}{250}</math> s or slower</li> <li>• <b>Electronic shutter:</b> Synchronizes with shutter at <math>X=\frac{1}{60}</math> s or slower</li> </ul>

Release	
Mode	<ul style="list-style-type: none"> <li>• Single frame, continuous</li> <li>• Self-timer, remote</li> </ul>
Frame advance rate	Approximately 5, 15, 30, or 60 fps
Self-timer	2 s, 10 s
Remote control modes	Delayed remote (2 s); quick-response remote

Exposure	
<b>Metering</b>	TTL metering using image sensor
<b>Metering method</b>	<ul style="list-style-type: none"> <li>• <b>Matrix</b></li> <li>• <b>Center-weighted:</b> Meters 4.5 mm circle in center of frame</li> <li>• <b>Spot:</b> Meters 2 mm circle centered on selected focus area</li> </ul>
<b>Mode</b>	P programmed auto with flexible program; S shutter-priority auto; A aperture-priority auto; M manual;  scene auto selector
<b>Exposure compensation</b>	-3 – +3 EV in increments of 1/3 EV (user controlled in P, S, and A modes)
<b>Exposure lock</b>	Luminosity locked at metered value with  (AE-L/AF-L) button
<b>ISO sensitivity (Recommended Exposure Index)</b>	ISO 160–6400 in steps of 1 EV; auto ISO sensitivity control (ISO 160–6400, 160–3200, 160–800) available (user controlled in P, S, A, and M modes)
<b>Active D-Lighting</b>	On, off
Focus	
<b>Autofocus</b>	Hybrid autofocus (phase detection/contrast-detect AF); AF-assist illuminator
<b>Lens servo</b>	<ul style="list-style-type: none"> <li>• <b>Autofocus (AF):</b> Single AF (AF-S); continuous AF (AF-C); auto AF-S/AF-C selection (AF-A); full-time AF (AF-F)</li> <li>• <b>Manual focus (MF)</b></li> </ul>
<b>AF-area mode</b>	Single-point, auto-area, subject tracking
<b>Focus area</b>	<ul style="list-style-type: none"> <li>• <b>Single-point AF:</b> 135 focus areas; the center 73 areas support phase-detection AF</li> <li>• <b>Auto-area AF:</b> 41 focus areas</li> </ul>
<b>Focus lock</b>	Focus can be locked by pressing shutter-release button halfway (single AF) or by pressing  (AE-L/AF-L) button
<b>Face priority</b>	On, off



Flash	
<b>Built-in flash</b>	Raised by pressing flash button
<b>Guide Number (GN)</b>	Approx. 5/16 (m/ft, ISO 100, 20 °C/68 °F; at ISO 160, Guide Number is approx. 6.3/20.7)
<b>Control</b>	i-TTL flash control using image sensor
<b>Mode</b>	Fill flash, fill flash + slow sync, red-eye reduction, red-eye reduction + slow sync, rear-curtain sync, rear curtain + slow sync
<b>Flash compensation</b>	-3–+1 EV in increments of 1/3 EV
<b>Flash-ready indicator</b>	Lights when flash is fully charged
White balance	
	Auto, incandescent, fluorescent, direct sunlight, flash, cloudy, shade, preset manual, all except preset manual with fine tuning
Movie	
<b>Metering</b>	TTL metering using image sensor
<b>Metering method</b>	<ul style="list-style-type: none"> <li>• <b>Matrix</b></li> <li>• <b>Center-weighted:</b> Meters 4.5 mm circle in center of frame</li> <li>• <b>Spot:</b> Meters 2 mm circle centered on selected focus area</li> </ul>
<b>Frame size (pixels)/recording rate</b>	<b>HD movies and movies recorded in , P, S, A, and M modes (aspect ratio 16 : 9)</b> <ul style="list-style-type: none"> <li>• 1920 × 1080/60i (59.94 fields/s*)</li> <li>• 1920 × 1080/30p (29.97 fps)</li> <li>• 1280 × 720/60p (59.94 fps)</li> <li>• 1280 × 720/30p (29.97 fps)</li> </ul> <b>Slow-motion movies (aspect ratio 8 : 3)</b> <ul style="list-style-type: none"> <li>• 640 × 240/400 fps (plays at 30p/29.97 fps)</li> <li>• 320 × 120/1200 fps (plays at 30p/29.97 fps)</li> </ul> <b>Motion Snapshot (aspect ratio 16 : 9)</b> <ul style="list-style-type: none"> <li>• 1920 × 1080/60p (59.94 fps) (plays at 24p/23.976 fps)</li> </ul>
<b>File format</b>	MOV
<b>Video compression</b>	H.264/MPEG-4 Advanced Video Coding
<b>Audio recording format</b>	AAC
<b>Audio recording device</b>	Built-in or optional external ME-1 stereo microphone; sensitivity adjustable

\* Sensor output is about 60 fps.



<b>Monitor</b>	7.5 cm (3-in.), approx. 921k-dot, TFT LCD with brightness adjustment
<b>Playback</b>	Full-frame and thumbnail (4, 9, or 72 images or calendar) playback with playback zoom, movie playback, slide show, histogram display, auto image rotation, and rating option
<b>Interface</b>	
<b>USB</b>	Hi-Speed USB
<b>HDMI output</b>	Type C mini-pin HDMI connector
<b>Multi accessory port</b>	Used for designated accessories
<b>Audio input</b>	Stereo mini-pin jack (3.5 mm diameter)
<b>Supported languages</b>	Arabic, Chinese (Simplified and Traditional), Czech, Danish, Dutch, English, Finnish, French, German, Greek, Hindi, Hungarian, Indonesian, Italian, Japanese, Korean, Norwegian, Polish, Portuguese (European and Brazilian), Romanian, Russian, Spanish, Swedish, Thai, Turkish, Ukrainian, Vietnamese
<b>Power source</b>	
<b>Battery</b>	One rechargeable Li-ion EN-EL21 battery
<b>AC adapter</b>	EH-5b AC adapter; requires EP-5D power connector (available separately)
<b>Tripod socket</b>	1/4-in. (ISO 1222)
<b>Dimensions/weight</b>	
<b>Dimensions (W × H × D)</b>	Approx. 107.8 × 81.6 × 45.9 mm (4.2 × 3.2 × 1.8 in.), excluding projections; thickness of body (from mount to monitor) is 33.2 mm (1.3 in.)
<b>Weight</b>	Approx. 337 g (11.9 oz) with battery and memory card but without body cap; approx. 278 g (9.8 oz), camera body only



<b>Operating environment</b>	
<b>Temperature</b>	0 °C–40 °C (+32 °F–104 °F)
<b>Humidity</b>	85% or less (no condensation)

- Unless otherwise stated, all figures are for a camera with a fully-charged battery operating at the temperature specified by the Camera and Imaging Products Association (CIPA): 23 ±3 °C (73.4 ±5.4 °F).
- Nikon reserves the right to change the specifications of the hardware and software described in this manual at any time and without prior notice. Nikon will not be held liable for damages that may result from any mistakes that this manual may contain.

<b>MH-28 battery charger</b>	
<b>Rated input</b>	AC 100–240 V, 50–60 Hz, 0.2 A
<b>Rated output</b>	DC 8.4 V/0.6 A
<b>Supported batteries</b>	Nikon EN-EL21 rechargeable Li-ion batteries
<b>Charging time</b>	Approx. 2 hours at an ambient temperature of 25 °C (77 °F) when no charge remains
<b>Operating temperature</b>	0 °C–40 °C (+32 °F–104 °F)
<b>Dimensions (W × H × D)</b>	Approx. 67.0 × 28.0 × 104.0 mm (2.6 × 1.1 × 4.1 in.), excluding plug adapter
<b>Weight</b>	Approx. 88 g (3.1 oz), excluding plug adapter

<b>EN-EL21 rechargeable Li-ion battery</b>	
<b>Type</b>	Rechargeable lithium-ion battery
<b>Rated capacity</b>	7.2 V, 1485 mAh
<b>Operating temperature</b>	0 °C–40 °C (+32 °F–104 °F)
<b>Dimensions (W × H × D)</b>	Approx. 37.6 × 49.7 × 18.1 mm (1.5 × 2.0 × 0.7 in.)
<b>Weight</b>	Approx. 57 g (2.0 oz), excluding terminal cover



**1 NIKKOR VR 10–30mm f/3.5–5.6**

Type	1 mount lens
Focal length	10–30 mm
Maximum aperture	f/3.5–5.6
Construction	12 elements in 9 groups (including 3 aspherical elements)
Angle of view	77°–29° 40'
Vibration reduction	Lens shift using voice coil motors (VCMs)
Minimum focus distance	0.2 m (0.7 ft) from focal plane at all zoom positions
Diaphragm blades	7 (rounded diaphragm opening)
Diaphragm	Fully automatic
Aperture range	• <b>10 mm focal length:</b> f/3.5–16 • <b>30 mm focal length:</b> f/5.6–16
Filter-attachment size	40.5 mm (P=0.5 mm)
Dimensions	Approx. 57.5 mm diameter × 42 mm (distance from camera lens mount flange when lens is retracted)
Weight	Approx. 115 g (4.1 oz)

**1 NIKKOR 11–27.5mm f/3.5–5.6**

Type	1 mount lens
Focal length	11–27.5 mm
Maximum aperture	f/3.5–5.6
Construction	8 elements in 6 groups (including 1 ED lens element and 1 aspherical lens element), 1 protective glass element
Angle of view	72°–32° 20'
Minimum focus distance	0.3 m (1.0 ft) from focal plane at all zoom positions
Diaphragm blades	7 (rounded diaphragm opening)
Diaphragm	Fully automatic
Aperture range	• <b>11 mm focal length:</b> f/3.5–16 • <b>27.5 mm focal length:</b> f/5.6–16
Filter-attachment size	40.5 mm (P=0.5 mm)
Dimensions	Approx. 57.5 mm diameter × 31 mm (distance from camera lens mount flange when lens is retracted)
Weight	Approx. 83 g (3.0 oz)

Specifications subject to change without notice. Nikon will not be held liable for damages that may result from any mistakes that this manual may contain.



### **Trademark Information**

Macintosh, Mac OS, and QuickTime are registered trademarks of Apple Inc. in the United States and/or other countries. Microsoft, Windows, and Windows Vista are either registered trademarks, or trademarks of Microsoft Corporation in the United States and/or other countries. The PictBridge logo is a trademark. The SD, SDHC, and SDXC logos are trademarks of SD-3C, LLC. HDMI, the HDMI logo and High-Definition Multimedia Interface are trademarks or registered trademarks of HDMI Licensing LLC.

## **HDMI**

All other trade names mentioned in this manual or the other documentation provided with your Nikon product are trademarks or registered trademarks of their respective holders.

### **FreeType License (FreeType2)**

Portions of this software are copyright © 2012 The FreeType Project (<http://www.freetype.org>). All rights reserved.

### **MIT License (HarfBuzz)**

Portions of this software are copyright © 2012 The HarfBuzz Project (<http://www.freedesktop.org/wiki/Software/HarfBuzz>). All rights reserved.



## Battery Life

---

The number of shots or movie footage that can be recorded with fully-charged batteries varies with the condition of the battery, temperature, the interval between shots, and the length of time menus are displayed. Sample figures for EN-EL21 (1485 mAh) batteries are given below.

- **Still images: Approximately 310 shots**
- **Movies: Approximately 65 minutes of HD footage at 1080/60i**

Measured according to CIPA standards at  $23 \pm 3$  °C ( $73.4 \pm 5.4$  °F) with the camera at default settings, a fully-charged battery, a 1 NIKKOR VR 10–30mm f/3.5–5.6 lens, and a 16 GB Toshiba SD-E016GUX UHS-I SDHC card. Value for still images obtained under the following test conditions: photographs taken at intervals of 30 s with the built-in flash fired with every other shot and the camera turned off and then on after every ten shots. Value for movies obtained under the following test conditions: a series of 20 minute movies with a file size of up to 4 GB were recorded; recording was only interrupted when temperature warning was displayed.

The following can reduce battery life:

- Keeping the shutter-release button pressed halfway
- Repeated autofocus operations
- Taking NEF (RAW) photographs
- Slow shutter speeds
- Using a wireless mobile adapter or Eye-Fi cards
- Using vibration reduction mode with VR lenses
- Using zoom with power zoom lenses

To ensure that you get the most from rechargeable Nikon EN-EL21 batteries:

- Keep the battery contacts clean. Soiled contacts can reduce battery performance.
- Use batteries immediately after charging. Batteries will lose their charge if left unused.



# Index

## Symbols

(Auto mode) .....	24
P (Programmed auto) .....	34
S (Shutter-priority auto) .....	35
A (Aperture-priority auto) .....	36
M (Manual) .....	37
(Best moment capture mode) .....	40
(Advanced movie mode) .....	47
(Motion Snapshot mode) .....	56
(Portrait) .....	27
(Landscape) .....	27
(Night portrait) .....	27
(Close up) .....	27
(Night landscape) .....	27
(Auto) .....	27
(flexible program) .....	34
(playback) button .....	30, 45, 59
(delete) button .....	31, 46, 55, 59
DISP (display) button .....	23
(feature) button .....	28, 42, 50, 58
(OK) button .....	16, 45, 54, 59

## A

AC adapter .....	78
Accessories .....	78
Advanced movie mode .....	47
Aperture .....	36, 37
Aperture-priority auto .....	36
Attaching the lens .....	22
Auto mode .....	24
Auto power off .....	27
Automatic scene selection .....	27

## B

Background track .....	59
Battery .....	20, 21, 96
Beep .....	26, 62
Best moment capture mode .....	40
Best shot .....	43, 45
Body cap .....	14, 15, 79

Buffering .....	44, 57
Built-in Flash .....	65

## C

Charging a battery .....	20
Clean image sensor .....	85
Close up .....	27
Command dial .....	30
Compatible lens .....	78
Computer .....	73
Continuous .....	60

## D

Delete .....	31, 46, 55, 59
Detailed display .....	17
Diopter adjustment control .....	18

## E

Electronic viewfinder .....	18
Exposure indicator .....	38
Eye sensor .....	18

## F

Face priority .....	27
Fill flash .....	65
Flash .....	65, 78
Flash mode .....	66
Flash range .....	67
Flash-ready indicator .....	65
Flexible program .....	34
Focal length .....	25
Focal length scale .....	25
Focal plane mark .....	15
Focus area .....	26
Focusing the viewfinder .....	18
Format .....	21
Format memory card .....	21
Full-frame playback .....	30

## G

Grid display .....	25
--------------------	----

<b>H</b>	
H.264 .....	94
HD Movies .....	47

<b>I</b>	
Infrared receiver .....	15, 63

<b>L</b>	
Landscape .....	27
Lens .....	22, 23, 25, 78, 97
Live image control .....	28

<b>M</b>	
Manual .....	37
Maximum aperture .....	97
Memory card .....	21, 80
Memory card access lamp .....	26
Microphone .....	48
Mode dial .....	19
Monitor .....	17, 23
Motion Snapshot mode .....	56
Mount adapter .....	78
Movie type .....	50
Movie-record button .....	32, 39, 48, 52
Movies .....	47

<b>N</b>	
Night landscape .....	27
Night portrait .....	27
Nikon Transfer 2 .....	75

<b>P</b>	
Playback .....	30
Portrait .....	27
Power connector .....	78
Power switch .....	22
Press the shutter-release button all the way down .....	26
Press the shutter-release button halfway .....	26
Programmed auto .....	34

<b>R</b>	
Rear-curtain sync .....	65

Red-eye reduction .....	65
Remote control .....	60
Retractable lens barrel button .....	23

<b>S</b>	
SD card .....	80
Self-timer .....	60
Short Movie Creator .....	73
Shutter speed .....	35, 37
Shutter-priority auto .....	35
Shutter-release button .....	26, 41, 44, 57
Single frame .....	60
Size .....	91, 94
Slow motion .....	51
Slow sync .....	65
Slow view .....	40, 42
Smart photo selector .....	42, 43
Speaker .....	15
Strap .....	20
System Requirements .....	74

<b>T</b>	
Temperature warnings .....	12
Theme .....	58
Timer .....	60

<b>U</b>	
USB cable .....	75

<b>V</b>	
Viewfinder .....	18
ViewNX 2 .....	73
Volume .....	54

<b>W</b>	
Wireless mobile adapter .....	79

<b>Z</b>	
Zoom ring .....	25



No reproduction in any form of this manual, in whole or in part (except for brief quotation in critical articles or reviews), may be made without written authorization from NIKON CORPORATION.

**NIKON CORPORATION**

© 2012 Nikon Corporation

Printed in China



SB2J01(11)  
6MVA4011-01