

# Nikon

DIGITAL CAMERA

# COOLPIX A300

## Quick Start Guide



Introduction	ii
Parts of the Camera	1
Getting Started	2
Basic Shooting and Playback Operations	8
Connecting to a Smart Device (SnapBridge)	13
Other Functions	19
Technical Notes	23

En

- Read this manual thoroughly before using the camera.
- To ensure proper use of the camera, be sure to read "For Your Safety" (page vi).
- After reading this manual, keep it in a readily accessible place for future reference.

# Introduction

## Read This First

Thank you for purchasing the Nikon COOLPIX A300 digital camera.

### Downloading the “Reference Manual”

The Reference Manual (PDF format) provides details in various languages on how to use this product. Download the Reference Manual from our Download Center at the URL below and save it on your smart device or computer for reference.

- The Reference Manual can be viewed using Adobe Acrobat Reader (downloadable from the Adobe website) or iBooks (an iOS app).

### Downloading Nikon Software

#### For Computer

Download the software from our Download Center at the URL below.

- ViewNX-i: This software enables you to transfer images and movies to your computer for viewing and editing.

#### For Smart Device

- SnapBridge: When you establish a wireless connection, this app enables you to upload images and movies to your smart device. See “Connecting to a Smart Device (SnapBridge)” (📖13) for information on how to download it and establish a connection.

### Visit Our Download Center

<http://downloadcenter.nikonimglib.com>

Visit our website to download manuals for Nikon imaging products, computer software, or firmware.



# Nikon User Support

Should you need technical support, we offer a number of options.

## Internet

For customers in the United States: [www.nikonusa.com](http://www.nikonusa.com)

For customers in Canada: [www.nikon.ca](http://www.nikon.ca) (English), [fr.nikon.ca](http://fr.nikon.ca) (Français)

For customers in Mexico: [www.nikon.com.mx](http://www.nikon.com.mx)

For customers in Brazil: [www.nikon.com.br](http://www.nikon.com.br)

## Telephone

For customers in the United States: **1-800-NIKON-US (1-800-645-6687)**

For customers in Canada: **1-877-534-9910**

For customers in Mexico: **001-888-565-5452**

For customers in Brazil: **0800-886-4566 (0800-88 NIKON)**

## Confirming the Package Contents

In the event that any items are missing, please contact the store where you purchased the camera.



- COOLPIX A300  
Digital Camera



- Camera Strap



- EN-EL19 Rechargeable  
Li-ion Battery



- EH-72P Charging AC  
Adapter\*

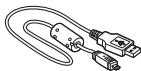

- UC-E16 USB Cable

- Quick Start Guide (this  
manual)

- Warranty

\* A plug adapter is included if the camera was purchased in a country or region that requires a plug adapter. The shape of the plug adapter varies with the country or region of purchase (📖4).

**NOTE:** A memory card is not included with the camera. SD, SDHC, and SDXC memory cards are referred to as "memory cards" in this manual.

# Information and Precautions

## Life-Long Learning

As part of Nikon's "Life-Long Learning" commitment to ongoing product support and education, continually updated information is available online at the following websites:

- For users in the U.S.A.: <http://www.nikonusa.com/>
- For users in Europe: <http://www.europe-nikon.com/support/>
- For users in Asia, Oceania, the Middle East, and Africa: <http://www.nikon-asia.com/>

Visit these websites to keep up-to-date with the latest product information, tips, answers to frequently asked questions (FAQs), and general advice on digital imaging and photography. Additional information may be available from the Nikon representative in your area. Visit the website below for contact information.

<http://imaging.nikon.com/>

## Use Only Nikon Brand Electronic Accessories

Nikon COOLPIX cameras are designed to the highest standards and include complex electronic circuitry. Only Nikon brand electronic accessories (including battery chargers, batteries, AC adapters, and USB cables) certified by Nikon specifically for use with this Nikon digital camera are engineered and proven to operate within the operational and safety requirements of this electronic circuitry.

THE USE OF NON-NIKON ELECTRONIC ACCESSORIES COULD DAMAGE THE CAMERA AND MAY VOID YOUR NIKON WARRANTY.

The use of third-party rechargeable Li-ion batteries not bearing the Nikon holographic seal could interfere with normal operation of the camera or result in the batteries overheating, igniting, rupturing, or leaking.

**Holographic seal:** Identifies this device as an authentic Nikon product.



For more information about Nikon brand accessories, contact a local authorized Nikon dealer.

## Before Taking Important Pictures

Before taking pictures on important occasions (such as at weddings or before taking the camera on a trip), take a test shot to ensure that the camera is functioning normally. Nikon will not be held liable for damages or lost profits that may result from product malfunction.

## About the Manuals

- No part of the manuals included with this product may be reproduced, transmitted, transcribed, stored in a retrieval system, or translated into any language in any form, by any means, without Nikon's prior written permission.
- Illustrations and screen content shown in this manual may differ from the actual product.
- Nikon reserves the right to change the specifications of the hardware and software described in these manuals at any time and without prior notice.
- Nikon will not be held liable for any damages resulting from the use of this product.
- While every effort was made to ensure that the information in these manuals is accurate and complete, we would appreciate it were you to bring any errors or omissions to the attention of the Nikon representative in your area (address provided separately).

## Comply with Copyright Notices

Under copyright law, photographs or recordings of copyrighted works made with the camera can not be used without the permission of the copyright holder. Exceptions apply to personal use, but note that even personal use may be restricted in the case of photographs or recordings of exhibits or live performances.

## Disposing of Data Storage Devices

Please note that deleting images or formatting data storage devices such as memory cards or built-in camera memory does not completely erase the original image data. Deleted files can sometimes be recovered from discarded storage devices using commercially available software, potentially resulting in the malicious use of personal image data. Ensuring the privacy of such data is the user's responsibility.

Before discarding a data storage device or transferring ownership to another person, be sure to perform **Reset all** in the setup menu (📖21) to reset camera settings. After that, erase all data using commercial deletion software or perform **Format card/Format memory** in the setup menu to format the device, then completely refill it with images containing no private information (for example, images of empty sky).

Care should be taken to avoid injury or damage to property when physically destroying memory cards.

## Conformity Marking

Follow the procedure below to display some of the conformity markings that the camera complies with.

Press the **MENU** button → **Y** menu icon → Conformity marking → **OK** button

## For Your Safety

To prevent damage to property or injury to yourself or to others, read "For Your Safety" in its entirety before using this product.

Keep these safety instructions where all those who use this product will read them.



### **DANGER**

**Failure to observe the precautions marked with this icon carries a high risk of death or severe injury.**



### **WARNING**

**Failure to observe the precautions marked with this icon could result in death or severe injury.**



### **CAUTION**

**Failure to observe the precautions marked with this icon could result in injury or property damage.**



### **WARNING**

- Do not use while walking or operating a motor vehicle. Failure to observe this precaution could result in accidents or other injury.
- Do not disassemble or modify this product. Do not touch internal parts that become exposed as the result of a fall or other accident. Failure to observe these precautions could result in electric shock or other injury.
- Should you notice any abnormalities such as the product producing smoke, heat, or unusual odors, immediately disconnect the battery or power source. Continued operation could result in fire, burns or other injury.
- Keep dry. Do not handle with wet hands. Do not handle the plug with wet hands. Failure to observe these precautions could result in fire or electric shock.
- Do not let your skin remain in prolonged contact with this product while it is on or plugged in. Failure to observe this precaution could result in low-temperature burns.
- Do not use this product in the presence of flammable dust or gas such as propane, gasoline or aerosols. Failure to observe this precaution could result in explosion or fire.
- Do not aim the flash at the operator of a motor vehicle. Failure to observe this precaution could result in accidents.

- Keep this product out of reach of children. Failure to observe this precaution could result in injury or product malfunction. In addition, note that small parts constitute a choking hazard. Should a child swallow any part of this product, seek immediate medical attention.

- Do not entangle, wrap or twist the straps around your neck. Failure to observe this precaution could result in accidents.

- Do not use batteries, chargers, or AC adapters not specifically designated for use with this product. When using batteries, chargers, and AC adapters designated for use with this product, do not:

- Damage, modify, forcibly tug or bend the cords or cables, place them under heavy objects, or expose them to heat or flame.
- Use travel converters or adapters designed to convert from one voltage to another or with DC-to-AC inverters.

Failure to observe these precautions could result in fire or electric shock.

- Do not handle the plug when charging the product or using the AC adapter during thunderstorms. Failure to observe this precaution could result in electric shock.

- Do not handle with bare hands in locations exposed to extremely high or low temperatures. Failure to observe this precaution could result in burns, or frostbite.



## CAUTION

- Turn this product off when its use is prohibited. Disable wireless features when the use of wireless equipment is prohibited. The radio-frequency emissions produced by this product could interfere with equipment onboard aircraft or in hospitals or other medical facilities.

- Remove the battery and disconnect the AC adapter if this product will not be used for an extended period. Failure to observe this precaution could result in fire or product malfunction.

- Do not touch moving parts of the lens or other moving parts. Failure to observe this precaution could result in injury.

- Do not fire the flash in contact with or in close proximity to the skin or objects. Failure to observe this precaution could result in burns or fire.

- Do not leave product where it will be exposed to extremely high temperatures, for an extended period such as in an enclosed automobile or in direct sunlight. Failure to observe this precaution could result in fire or product malfunction.



## **DANGER for Rechargeable Batteries**

- Do not mishandle batteries. Failure to observe the following precautions could result in the batteries leaking, overheating, rupturing, or catching fire:
  - Use only rechargeable batteries approved for use in this product.
  - Do not expose batteries to flame or excessive heat.
  - Do not disassemble.
  - Do not short circuit the terminals by touching them to necklaces, hairpins, or other metal objects.
  - Do not expose batteries or the products in which they are inserted to powerful physical shocks.

---

- Do not attempt to recharge the EN-EL19 rechargeable batteries by using a camera or charger that is not specifically designed to recharge the EN-EL19. Failure to observe this precaution could result in the batteries leaking, overheating, rupturing, or catching fire.

---

- If battery liquid comes into contact with the eyes, rinse with plenty of clean water and seek immediate medical attention. Delaying action could result in eye injuries.



## **WARNING for Rechargeable Batteries**

- Keep batteries out of reach of children. Should a child swallow a battery, seek immediate medical attention.

---

- Do not immerse batteries in water or expose to rain. Failure to observe this precaution could result in fire or product malfunction. Immediately dry the product with a towel or similar object should it become wet.

---

- Discontinue use immediately should you notice any changes in the batteries, such as discoloration or deformation. Cease charging EN-EL19 rechargeable batteries if they do not charge in the specified period of time. Failure to observe this precaution could result in the batteries leaking, overheating, rupturing, or catching fire.

---

- Prior to disposal, insulate battery terminals with tape. Overheating, rupture, or fire may result should metal objects come into contact with the terminals. Recycle or dispose of batteries in accord with local regulations.

---

- If battery liquid comes into contact with a person's skin or clothing, immediately rinse the affected area with plenty of clean water. Failure to observe this precaution could result in skin irritation.



# Parts of the Camera

## The Camera Body

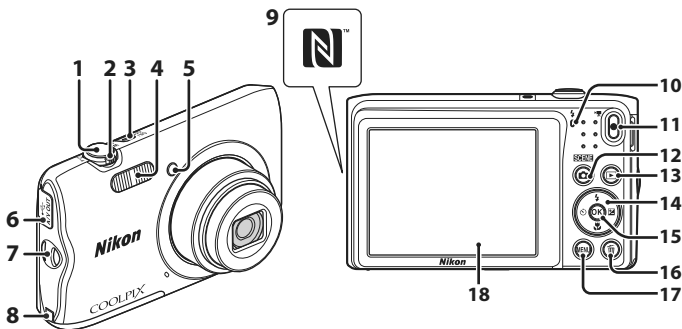

- 1 Shutter-release button
- 2 Zoom control  
**W**: Wide-angle  
**T**: Telephoto  
: Thumbnail playback  
**Q**: Playback zoom
- 3 Power switch/power-on lamp
- 4 Flash
- 5 Self-timer lamp  
AF-assist illuminator
- 6 Connector cover
- 7 Eyelet for camera strap
- 8 Power connector cover (for connection with optional AC adapter)
- 9 N-Mark (NFC antenna)

- 10 Charge lamp  
Flash lamp
- 11 (movie-record) button
- 12 (shooting mode) button
- 13 (playback) button
- 14 Multi selector
- 15 (apply selection) button
- 16 (delete) button
- 17 **MENU** (menu) button
- 18 Monitor

# Getting Started

## How to Attach the Camera Strap

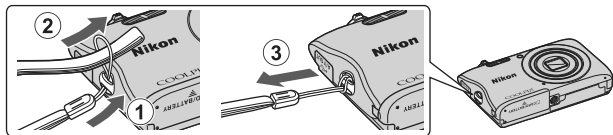

## Inserting the Battery and Memory Card

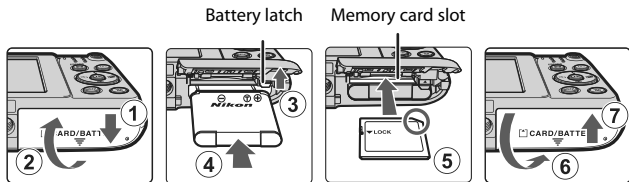

- With the battery's positive and negative terminals oriented correctly, move the orange battery latch (3), and fully insert the battery (4).
- Slide the memory card in until it clicks into place (5).
- Be careful not to insert the battery or memory card upside-down or backward, as this could cause a malfunction.

### ✓ Formatting a Memory Card

The first time you insert a memory card that has been used in another device into this camera, make sure to format it with this camera.

- **Note that formatting a memory card permanently deletes all images and other data on the memory card.** Be sure to make copies of any images you wish to keep before formatting the memory card.
- Insert the memory card into the camera, press the **MENU** button, and select **Format card** in the setup menu (21).

### Removing the Battery or Memory Card

Turn the camera off and make sure that the power-on lamp and screen have turned off, and then open the battery-chamber/memory card slot cover.

- Move the battery latch to eject the battery.
- Gently push the memory card into the camera to partially eject the memory card.
- Be careful when handling the camera, battery, and memory card immediately after using the camera, as they may be hot.

### Memory Cards and Internal Memory

Camera data, including images and movies, can be saved either on a memory card or in the camera's internal memory. To use the camera's internal memory, remove the memory card.

# Charging the Battery

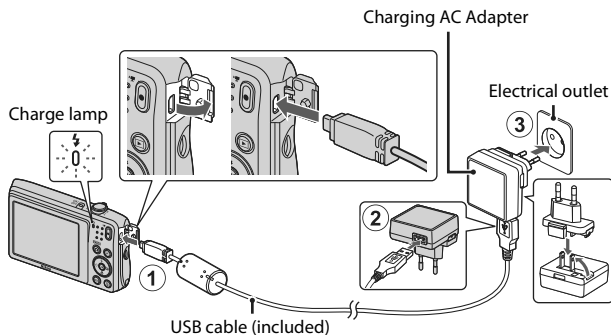

If a plug adapter\* is included with your camera, securely connect it to the Charging AC Adapter. Once the two are connected, attempting to forcibly remove the plug adapter could damage the product.

\* The shape of the plug adapter varies according to the country or region in which the camera was purchased. This step can be omitted if the plug adapter comes permanently bonded to the Charging AC Adapter.

- Charging starts when the camera is connected to an electrical outlet while the battery is inserted, as shown in the illustration. The charge lamp slowly flashes while the battery is charging.
- When charging is complete, the charge lamp turns off. Unplug the Charging AC Adapter from the electrical outlet, and disconnect the USB cable. Charging time is about 2 hours and 40 minutes for a fully exhausted battery.
- The battery cannot be charged when the charge lamp quickly flashes, possibly due to one of the reasons described below.
  - The ambient temperature is not suited to charging.
  - The USB cable or Charging AC Adapter is not properly connected.
  - The battery is damaged.

## **Notes About the USB Cable**

Check the shape and direction of the plugs and do not insert or remove the plugs at an angle.

## **Turning the Camera On While Charging**

If you press the power switch while charging with the Charging AC Adapter, the camera turns on in playback mode, and captured images can be played back. Shooting is not possible.

## **Charging Using a Computer or Battery Charger**

- You can also charge the battery by connecting the camera to a computer.
- You can use the MH-66 Battery Charger (available separately) to charge the battery without using the camera.

# Camera Setup

## 1 Press the power switch to turn the camera on.

- Use the multi selector to select and adjust settings.

Power switch

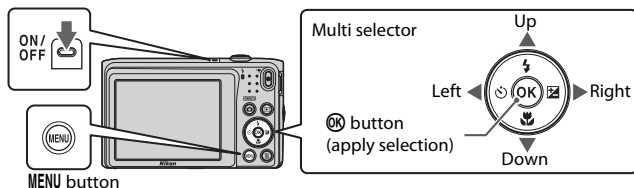

- A language selection dialog will be displayed. Use ▲▼ on the multi selector to highlight a language and press the OK button to select.
- The language can be changed at any time using the **Language** option in the setup menu (📖21).

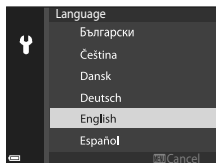

## 2 When the dialog shown on the right is displayed, press the MENU or OK button as indicated below.

- When not wirelessly connecting to a smart device: Press **MENU** to proceed to step 3.
- When wirelessly connecting to a smart device: Press the **OK** button. See “Connecting to a Smart Device (SnapBridge)” (📖13) for details on the setup procedure.



## 3 Use ▲▼ to choose **Yes** when **Choose time zone and set date and time?** is displayed, and press the OK button.

---

#### 4 Highlight your home time zone and press the **OK** button.

- To turn daylight saving time on, press ▲. The clock is set ahead one hour and ☀️ is displayed at the top of the map. Press ▼ to turn daylight saving time off.

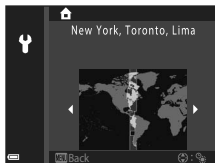

---

#### 5 Use ▲▼ to choose a date format and press the **OK** button.

#### 6 Enter the current date and time and press the **OK** button.

- Use ◀▶ to highlight items and use ▲▼ to change.
- Press the **OK** button to set the clock.

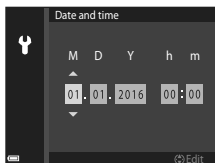



---

#### 7 When prompted, choose **Yes** and press the **OK** button.

- The shooting screen is displayed when setup is complete.
- You can change the time zone and set the camera clock in **Time zone and date** in the setup menu (📖21).

# Basic Shooting and Playback Operations

## Shooting Images

 (scene auto selector) mode is used here as an example. In  (scene auto selector) mode, the camera automatically recognizes the shooting scene when you frame a picture, making it easier to take pictures using settings that suit the scene.

### 1 Hold the camera steady.

- Keep fingers and other objects away from the lens, flash, AF assist-illuminator, microphone, and speaker.
- When taking pictures in portrait ("tall") orientation, turn the camera so that the flash is above the lens.

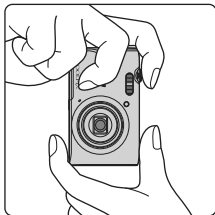
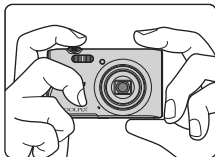



### 2 Frame the picture.

- Move the zoom control to change the zoom lens position.

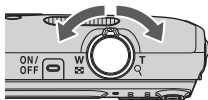
Zoom out      Zoom in





- When the camera recognizes the shooting scene, the shooting mode icon changes accordingly.
- Battery level indicator
  - : The battery level is high.
  - : The battery level is low.
- Number of exposures remaining
  -  is displayed when no memory card is inserted in the camera, and images are saved in the internal memory.

#### Shooting mode icon



Battery level indicator

Number of exposures remaining

### 3 Press the shutter-release button halfway.

- To press the shutter-release button "halfway" means to press and hold the button at the point where you feel a slight resistance.
- When the subject is in focus, the focus area or focus indicator is displayed in green.
- When you are using digital zoom, the camera focuses in the center of the frame and the focus area is not displayed.
- If the focus area or focus indicator flashes, the camera is unable to focus. Modify the composition and try pressing the shutter-release button halfway again.

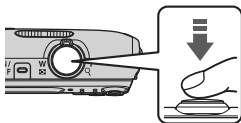

### 4 Without lifting your finger, press the shutter-release button all the way down.





#### Notes About Saving Images or Movies

The indicator showing the number of exposures remaining or the indicator showing the remaining recording time flashes while images or movies are being saved. **Do not open the battery-chamber/memory card slot cover or remove the battery or memory card** while an indicator is flashing. Doing this could result in loss of data, or in damage to the camera or the memory card.





## The Auto Off Function

- When no operations are performed for about one minute, the screen turns off, the camera enters standby mode, and then the power-on lamp flashes. The camera turns off after remaining in standby mode for about three minutes.
- To turn the screen back on while the camera is in standby mode, perform an operation such as pressing the power switch or shutter-release button.

## When Using a Tripod

- We recommend using a tripod to stabilize the camera in the following situations:
  - When shooting in dim lighting with the flash mode () set to  (off)
  - When the zoom is at a telephoto position
- When using a tripod to stabilize the camera during shooting, set **Photo VR to Off** in the setup menu () to prevent potential errors caused by this function.

## Recording Movies

Display the shooting screen and press the  (●) (▶) (movie-record) button to start recording a movie. Press the  (●) (▶) button again to end recording.

- To play back a movie, select a movie in full-frame playback mode and press the  button.

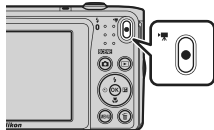



# Playing Back Images

**1** Press the  (playback) button to enter playback mode.

- If you press and hold down the  button while the camera is turned off, the camera turns on in playback mode.





**2** Use the multi selector to select an image to display.

- Press and hold down    to scroll through the images quickly.
- To return to shooting mode, press the  button or shutter-release button.

Display the previous image



Display the next image

- When  is displayed in full-frame playback mode, you can press the  button to apply an effect to the image.



- Move the zoom control toward  in full-frame playback mode to zoom in on an image.





- In full-frame playback mode, move the zoom control toward  to switch to thumbnail playback mode and display multiple images on the screen.



## Deleting Images

- 1 Press the  (delete) button to delete the image currently displayed on the screen.



- 2 Use the multi selector   to select the desired deletion method and press the  button.

- To exit without deleting, press the **MENU** button.

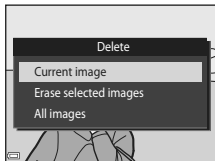

- 3 Select **Yes** and press the  button.

- Deleted images cannot be recovered.

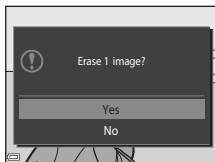

### Deleting the Image Captured While in Shooting Mode

When using shooting mode, press the  button to delete the last image that was saved.

# Connecting to a Smart Device (SnapBridge)

## Installing the SnapBridge App

When you install the SnapBridge app on your smart device and establish a wireless connection between the smart device and a SnapBridge-supported camera, you can upload images captured with the camera to the smart device, or use the smart device to release the camera shutter (📖17).



- This manual describes the procedures for version 2.0 of the SnapBridge app. Use the latest version of the SnapBridge app. The operating procedures may vary depending on the camera's firmware, version of the SnapBridge app, or OS of the smart device.
- See the manual of your smart device for details on how to operate the smart device.

### 1 Install the SnapBridge app on the smart device.

- Download the app from the Apple App Store® for iOS, and from Google Play™ for Android™. Search for “snapbridge” and then install it.



- Visit the applicable download site for more information about supported OS versions.
- The “SnapBridge 360/170 app” cannot be used with this camera.

### 2 Enable Bluetooth and Wi-Fi on the smart device.

- **Use the SnapBridge app to connect to the camera. You cannot connect from the Bluetooth settings screen on the smart device.**

#### Screens in the SnapBridge App

- ① You can view notices from Nikon and the SnapBridge app Help, as well as configure the app's settings.
- ② Primarily perform connection settings for smart devices and cameras.
- ③ You can view, delete, or share the images that are downloaded from the camera.

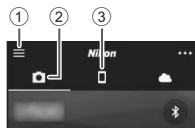

# Connecting the Camera and a Smart Device

- Use a sufficiently charged battery so that the camera does not turn off during the procedure.
- Insert a memory card with sufficient free space into the camera.

## 1 Camera: Select **Network menu** (📖21) → **Connect to smart device**, and press the **OK** button.

- The screen in step 2 is displayed when you turn the camera on for the first time. This step is unnecessary in such cases.

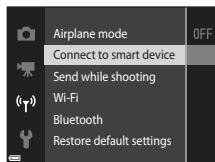

## 2 Camera: Press the **OK** button when the screen shown on the right is displayed.

- A dialog prompting you whether to use the NFC function is displayed. If you will use the NFC function, touch the NFC antenna of the smart device to **N** (N-mark) on the camera. When **Start pairing?** is displayed on the smart device, tap **OK** and proceed to step 7. If you will not use the NFC function, press the **OK** button.

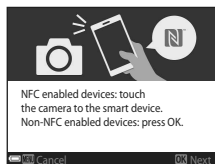
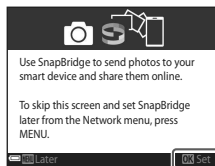

## 3 Camera: Confirm that the screen shown on the right is displayed.

- Prepare the smart device and proceed to the next step.

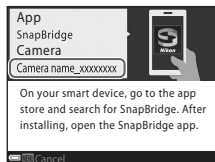

## 4 Smart device: Launch the SnapBridge app and tap **Pair with camera**.

- When the dialog to select a camera is displayed, tap the camera you want to connect to.
- If you did not connect to the camera by tapping **Skip** at the upper-right of the screen when launching the SnapBridge app for the first time, tap **Pair with camera** in the  tab and proceed to step 5.



## 5 Smart device: In the **Pair with camera** screen, tap the camera name.

- For iOS, if a dialog explaining the procedure is displayed when connecting, confirm the details and tap **Understood** (if it is not displayed, scroll down the screen). Tap the camera name again when the screen to select an accessory is displayed (it may take some time for the camera name to be displayed).

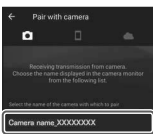

## 6 Camera/smart device: Confirm that the camera and smart device display the same number (six digits).

- For iOS, the number may not be displayed on the smart device depending on the OS version. Proceed to step 7 in such cases.

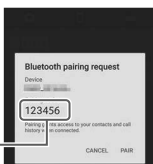
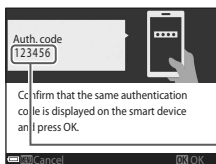

## 7 Camera/smart device: Press the button on the camera and tap **PAIR** in the SnapBridge app.

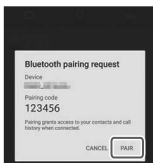



## 8 Camera/smart device: Finish the connection settings.

Camera: Press the **OK** button when the screen shown on the right is displayed.

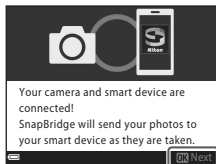
Smart device: Tap **OK** when the dialog indicating that pairing is complete is displayed.



## 9 Camera: Follow the on-screen instructions to complete the setup process.

- To record location data with photographs, select **Yes** when **Download location data from smart device?** is displayed. Enable the location data functions on the smart device, and enable **Synchronize location data** in the  tab → **Auto link options** in the SnapBridge app.
- You can synchronize the camera clock to the time reported by the smart device by selecting **Yes** when **Sync clock with smart device?** is displayed. Enable **Synchronize clocks** in the  tab → **Auto link options** in the SnapBridge app.

**Connecting the camera and smart device is complete.**

**Still images captured with the camera are automatically uploaded to the smart device.**

### **To Learn More About Using the SnapBridge App and the Camera**

- See the online help for details on how to use the SnapBridge app (after connecting, refer to the SnapBridge app menu → **Help**).  
<http://nikonimglib.com/snbr/onlinehelp/en/index.html>
- See the documentation “Reference Manual” (PDF format) provided with the camera for details on how to use it. You can download it from the Download Center.  
<http://downloadcenter.nikonimglib.com>

### **If the Connection Is Unsuccessful**

- If the camera displays **Could not connect.** when connecting.
  - Press the **OK** button and repeat the procedure from step 2 in “Connecting the Camera and a Smart Device” (📖 14) to connect again.
  - Press the **MENU** button to cancel the connection.
- The issue may be solved by relaunching the app. Close the SnapBridge app completely and then tap the app icon again to launch it. When the app launches, repeat the procedure from step 1 in “Connecting the Camera and a Smart Device” (📖 14).



## Disabling or Enabling the Wireless Connection

Use any of the following methods to disable or enable the connection.

- Switch the setting in **Network menu** → **Airplane mode** in the camera. You can set it to **On** to turn off all communication functions in places where wireless communication is prohibited.
- Switch the setting in **Network menu** → **Bluetooth** → **Connection** in the camera.
- Switch the setting in the  tab → **Auto link options** → **Auto link** in the SnapBridge app.  
You can reduce battery consumption of the smart device by disabling this setting.

## Image Upload and Remote Photography

### Image Upload

There are three ways to upload images.

- Movies recorded with this camera cannot be uploaded.



Automatically upload images to the smart device every time they are captured. <sup>1, 2</sup>	<b>Network menu</b> in the camera → <b>Send while shooting</b> → set <b>Still images</b> to <b>Yes</b> .
Select images in the camera and upload them to the smart device. <sup>1, 2</sup>	<b>Playback menu</b> in the camera → use <b>Mark for upload</b> to select images.
Use the smart device to select images in the camera and download them to the smart device.	 tab in the SnapBridge app → tap <b>Download pictures</b> . A dialog related to Wi-Fi connections is displayed. Tap <b>OK</b> <sup>3</sup> and select images.

<sup>1</sup> The size of images that are uploaded is 2 megapixels.

<sup>2</sup> When **Network menu** → **Bluetooth** → **Send while off** in the camera is set to **On**, images are uploaded to the smart device automatically even when the camera is turned off.

<sup>3</sup> Depending on the iOS version, you must select the camera SSID when you tap **OK**. See “If a Dialog Related to Wi-Fi Connections Is Displayed in iOS” (📖18) for more information.

### ✓ Notes About When in a Wi-Fi Connection

- If the smart device enters sleep mode or you switch from the SnapBridge app to another app, the Wi-Fi connection will be disconnected.
- Some functions of the SnapBridge app cannot be used during a Wi-Fi connection. To cancel a Wi-Fi connection, tap the  tab →  → **Yes**.

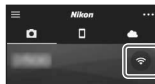

## Remote Photography

You can tap the  tab in the SnapBridge app → **Remote photography** to release the camera shutter using a smart device.

- Follow the instructions in the SnapBridge app to switch to a Wi-Fi connection. In iOS, a dialog related to Wi-Fi connections may be displayed. In such cases, see “If a Dialog Related to Wi-Fi Connections Is Displayed in iOS” (📖18).

## If a Dialog Related to Wi-Fi Connections Is Displayed in iOS

The SnapBridge app normally connects the camera and smart device via Bluetooth. However, switch to a Wi-Fi connection when using **Download pictures** or remote photography. Depending on the iOS version, you must switch the connection manually. In such cases, use the following procedure to set the connection.

- 1** Write down the camera SSID (camera name at default) and password displayed on the screen in the smart device, and then tap **View options**.

- You can change the SSID or password by using **Network menu** → **Wi-Fi** → **Network settings** in the camera. To protect your privacy, we recommend that you change the password regularly. Disable the wireless connection when changing the password (📖17).

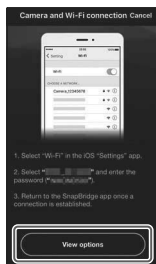

- 2** Select the SSID you wrote down in step 1 from the list of connections.

- When you establish a wireless connection for the first time, input the password you wrote down in step 1 while making sure to enter the uppercase and lowercase characters correctly. Inputting the password is unnecessary after the first time connecting.
- The Wi-Fi connection is complete when ✓ is displayed next to the camera SSID, as shown on the screen at right. Return to the SnapBridge app and operate the app.



# Other Functions

## Selecting a Shooting Mode

The shooting modes described below are available.

- **SCN Scene auto selector**

The camera automatically recognizes the shooting scene when you frame a picture, making it easier to take pictures using settings that suit the scene.

- **S Scene mode**

Camera settings are optimized according to the scene that you select.

- **SO Special effects**

Apply effects to images during shooting.

- **SR Smart portrait**



Use glamour retouch to enhance human faces during shooting, and use the smile timer or self-collage function to take pictures.



- **Auto mode**

Used for general shooting. Settings can be changed to suit the shooting conditions and the type of shot that you want to capture.

- 1 When the shooting screen is displayed, press the  (shooting mode) button.



- 2 Use the multi selector   to select a shooting mode and press the  button.

- When scene mode or special effects mode is selected, press  to select a scene mode or effect before pressing the  button.



### Help Display

The descriptions of functions are displayed while changing the shooting mode or while the setting screen is displayed.

You can show or hide the descriptions using **Help display** in **Monitor settings** in the setup menu.

## Setting Shooting Functions with the Multi Selector

When the shooting screen is displayed, you can press the multi selector ▲ (⚡) ◀ (⌚) ▼ (🌸) ▶ (☒) to set the functions described below.







- **⚡ Flash mode**  
You can select a flash mode to match the shooting conditions.
- **⌚ Self-timer**  
The camera releases the shutter 10, 2, or 5 seconds after you press the shutter-release button.
- **🌸 Macro mode**  
Use macro mode when you take close-up pictures.
- **☒ Exposure compensation**  
You can adjust overall image brightness.

The functions that can be set vary depending on the shooting mode.

# Menu Operations

You can set the menus listed below by pressing the **MENU** (menu) button.

-  **Shooting menu**<sup>1,2</sup>
-  **Movie menu**<sup>1</sup>
-  **Playback menu**<sup>3</sup>
-  **Network menu**
-  **Setup menu**

<sup>1</sup> Press the **MENU** button when the shooting screen is displayed.

<sup>2</sup> Menu icons and available setting options vary depending on the shooting mode.

<sup>3</sup> Press the **MENU** button when the playback screen is displayed.

## 1 Press the **MENU** (menu) button.

- The menu is displayed.



## 2 Press the multi selector ◀.

- The current menu icon is displayed in yellow.

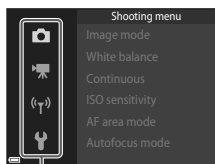

Menu icons

## 3 Select a menu icon and press the **OK** button.

- The menu options become selectable.

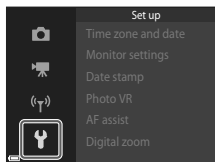

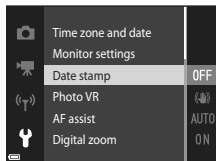

## 4 Select a menu option and press the **OK** button.

- Certain menu options cannot be set depending on the current shooting mode or the state of the camera.



## 5 Select a setting and press the **OK** button.

- The setting you selected is applied.
- When you are finished using the menu, press the **MENU** button.
- When a menu is displayed, you can switch to shooting mode by pressing the shutter-release button,  button, or .

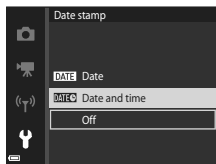

# Technical Notes

## Notices

### Notices for Customers in the U.S.A.

#### **IMPORTANT SAFETY INSTRUCTIONS - SAVE THESE INSTRUCTIONS.**

#### **DANGER - TO REDUCE THE RISK OF FIRE OR ELECTRIC SHOCK, CAREFULLY FOLLOW THESE INSTRUCTIONS**

For connection to a supply not in the U.S.A., use an attachment plug adapter of the proper configuration for the power outlet if needed.

The power supply unit is intended to be correctly orientated in a vertical or floor mount position.

#### **Federal Communications Commission (FCC) Radio Frequency Interference Statement**

This equipment has been tested and found to comply with the limits for a Class B digital device, pursuant to Part 15 of the FCC rules. These limits are designed to provide reasonable protection against harmful interference in a residential installation.

This equipment generates, uses, and can radiate radio frequency energy and, if not installed and used in accordance with the instructions, may cause harmful interference to radio communications. However, there is no guarantee that interference will not occur in a particular installation. If this equipment does cause harmful interference to radio or television reception, which can be determined by turning the equipment off and on, the user is encouraged to try to correct the interference by one or more of the following measures:

- Reorient or relocate the receiving antenna.
- Increase the separation between the equipment and receiver.
- Connect the equipment into an outlet on a circuit different from that to which the receiver is connected.
- Consult the dealer or an experienced radio/television technician for help.

#### **CAUTIONS**

##### **Modifications**

The FCC requires the user to be notified that any changes or modifications made to this device that are not expressly approved by Nikon Corporation may void the user's authority to operate the equipment.

##### **Interface Cables**

Use the interface cables sold or provided by Nikon for your equipment. Using other interface cables may exceed the limits of Class B Part 15 of the FCC rules.



**Nikon**

**COOLPIX A300**

## **Notice for Customers in the State of California**

### **WARNING**

Handling the cord on this product will expose you to lead, a chemical known to the State of California to cause birth defects or other reproductive harm.

### **Wash hands after handling.**

Nikon Inc.,

1300 Walt Whitman Road, Melville, New York 11747-3064, U.S.A.

Tel: 631-547-4200

## **Notice for Customers in Canada**

CAN ICES-3 B / NMB-3 B



# Notes About Wireless Communication Functions

## Restrictions on Wireless Devices

The wireless transceiver included in this product conforms to wireless regulations in the country of sale and is not for use in other countries (products purchased in the EU or EFTA can be used anywhere within the EU and EFTA). Nikon does not accept liability for use in other countries. Users who are unsure as to the original country of sale should consult with their local Nikon service center or Nikon-authorized service representative. This restriction applies to wireless operation only and not to any other use of the product.

## Security

Although one of the benefits of this product is that it allows others to freely connect for the wireless exchange of data anywhere within its range, the following may occur if security is not enabled:

- Data theft: Malicious third-parties may intercept wireless transmissions to steal user IDs, passwords, and other personal information.
- Unauthorized access: Unauthorized users may gain access to the network and alter data or perform other malicious actions. Note that due to the design of wireless networks, specialized attacks may allow unauthorized access even when security is enabled. Nikon is not responsible for data or information leaks that may occur during data transfer.
- Do not access networks that you are not permitted to use, even if they are displayed on your smartphone or tablet. Doing so may be regarded as unauthorized access. Only access networks that you are permitted to use.

## Personal Information Management and Disclaimer

- User information registered and configured on the product, including wireless LAN connection settings and other personal information, is susceptible to alteration and loss resulting from operational error, static electricity, accident, malfunction, repair or other handling. Always keep separate copies of important information. Nikon is not responsible for any direct or indirect damages or lost profits resulting from alteration or loss of content that is not attributable to Nikon.
- Before discarding this product or transferring it to another owner, perform **Reset all** in the setup menu (📖21) to delete all user information registered and configured with the product, including wireless LAN connection settings and other personal information.
- Nikon is not responsible for any damages resulting from unauthorized use of this product by third parties in the event that the product is stolen or lost.

### **Precautions when Exporting or Carrying This Product Abroad**

This product is controlled by the United States Export Administration Regulations (EAR). The permission of the United States government is not required for export to countries other than the following, which as of this writing are subject to embargo or special controls: Cuba, Iran, North Korea, Sudan, and Syria (list subject to change).

## **Notice for Customers in the U.S.A. and Canada**

### **Federal Communications Commission (FCC) and Industry of Canada (IC)**

#### **Declaration of Conformity**

This device complies with Part 15 of FCC Rules and Industry Canada licence-exempt RSS standard(s). Operation is subject to the following two conditions: (1) this device may not cause interference, and (2) this device must accept any interference, including interference that may cause undesired operation of this device.

#### **FCC/IC RF Exposure Statement**

This transmitter must not be co-located or operated in conjunction with any other antenna or transmitter.

The available scientific evidence does not show that any health problems are associated with using low power wireless devices. There is no proof, however, that these low power wireless devices are absolutely safe. Low power wireless devices emit low levels of radio frequency energy (RF) in the microwave range while being used. Whereas high levels of RF can produce health effects (by heating tissue), exposure of low-level RF that does not produce heating effects causes no known adverse health effects. Many studies of low-level RF exposures have not found any biological effects. Some studies have suggested that some biological effects might occur, but such findings have not been confirmed by additional research.

COOLPIX A300, which is equipped with a WM-BN-BM-26\_A (FCC ID:2AAD3JA1D0J0 / IC ID:4634A-3152EC) Wireless LAN Module, has been tested and found to comply with FCC/IC radiation exposure limits set forth for an uncontrolled environment and meets the FCC radio frequency (RF) Exposure Guidelines in Supplement C to OET65 and RSS-102 of the IC radio frequency (RF) Exposure rules. Please refer to the SAR test report that was uploaded to FCC website.

## Caring for the Product

Observe the precautions described below in addition to the warnings in “For Your Safety” (📖vi–viii) when using or storing the device.

### The Camera

#### **Do Not Apply Strong Impact to the Camera**

The product may malfunction if subjected to strong shock or vibration. In addition, do not touch or apply force to the lens or lens cover.

#### **Keep Dry**

The device will be damaged if immersed in water or subjected to high humidity.

#### **Avoid Sudden Changes in Temperature**

Sudden changes in temperature, such as when entering or leaving a heated building on a cold day, can cause condensation to form inside the device. To prevent condensation, place the device in a carrying case or a plastic bag before exposing it to sudden changes in temperature.

#### **Keep Away from Strong Magnetic Fields**

Do not use or store this device in the vicinity of equipment that generates strong electromagnetic radiation or magnetic fields. Doing so could result in loss of data or camera malfunction.

#### **Do Not Point the Lens at Strong Light Sources for Extended Periods**

Avoid pointing the lens at the sun or other strong light sources for extended periods when using or storing the camera. Intense light may cause the image sensor to deteriorate or produce a white blur effect in photographs.

#### **Turn the Product Off Before Removing or Disconnecting the Power Source or Memory Card**

Do not remove the battery while the product is on, or while images are being saved or deleted. Forcibly cutting power in these circumstances could result in loss of data or in damage to the memory card or internal circuitry.

## Notes About the Monitor

- Monitors (including electronic viewfinders) are constructed with extremely high precision; at least 99.99% of pixels are effective, with no more than 0.01% being missing or defective. Hence while these displays may contain pixels that are always lit (white, red, blue, or green) or always off (black), this is not a malfunction and has no effect on images recorded with the device.
- Images in the monitor may be difficult to see under bright lighting.
- Do not apply pressure to the monitor, as this could cause damage or malfunction. Should the monitor break, care should be taken to avoid injury caused by broken glass and to prevent the liquid crystal from the display touching the skin or entering the eyes or mouth.

## Notes About Smear

White or colored streaks may be visible when bright subjects are framed in the monitor. This phenomenon, known as “smear,” occurs when extremely bright light strikes the image sensor; it is characteristic of image sensors and does not indicate a malfunction. Smear may also take the form of partial discoloration in the monitor during shooting. It does not appear in images saved with the camera except in the cases of movies. When recording movies, we recommend that you avoid bright subjects such as the sun, reflected sunlight, and electric lights.

## The Battery

### Precautions for Use

- Note that the battery may become hot after use.
- Do not use the battery at ambient temperatures below 0°C (32°F) or above 40°C (104°F) as this could cause damage or malfunction.
- If you notice any abnormalities such as excessive heat, smoke, or an unusual smell coming from the battery, immediately discontinue use and consult your retailer or Nikon-authorized service representative.
- After removing the battery from the camera or optional battery charger, put the battery in a plastic bag, etc. in order to insulate it.

### Charging the Battery

Check the battery level before using the camera and replace or charge the battery if necessary.

- Charge the battery indoors with an ambient temperature of 5°C to 35°C (41°F to 95°F) before use.
- A high battery temperature may prevent the battery from charging properly or completely, and may reduce battery performance. Note that the battery may become hot after use; wait for the battery to cool before charging.

When charging the battery inserted into this camera using the Charging AC Adapter or a computer, the battery is not charged at battery temperatures below 0°C (32°F) or above 45°C (113°F).

- Do not continue charging once the battery is fully charged as this will result in reduced battery performance.
- The battery temperature may increase during charging. However, this is not a malfunction.

## Carrying Spare Batteries

Whenever possible, carry fully charged spare batteries when taking pictures on important occasions.

## Using the Battery When Cold

On cold days, the capacity of batteries tends to decrease. If an exhausted battery is used at a low temperature, the camera may not turn on. Keep spare batteries in a warm place and exchange as necessary. Once warmed, a cold battery may recover some of its charge.

## Battery Terminals

Dirt on the battery terminals may prevent the camera from functioning. Should the battery terminals become dirty, wipe them off with a clean, dry cloth before use.

## Charging an Exhausted Battery

Turning the camera on or off while an exhausted battery is inserted in the camera may result in reduced battery life. Charge the exhausted battery before use.

## Storing the Battery

- Always remove the battery from the camera or optional battery charger when it is not being used. Minute amounts of current are drawn from the battery while it is in the camera, even when not in use. This may result in excessive battery drain and complete loss of function.
- Recharge the battery at least once every six months and completely exhaust it before returning it to storage.
- Put the battery in a plastic bag, etc. in order to insulate it and store it in a cool place. The battery should be stored in a dry location with an ambient temperature of 15°C to 25°C (59°F to 77°F). Do not store the battery in hot or extremely cold locations.

## Battery Life

A marked drop in the time a fully charged battery retains its charge, when used at room temperature, indicates that the battery needs to be replaced. Purchase a new battery.

## Recycling Used Batteries

Replace the battery when it no longer holds a charge. Used batteries are a valuable resource. Please recycle used batteries in accordance with local regulations.

## The Charging AC Adapter

- The EH-72P Charging AC Adapter is for use only with compatible devices. Do not use with another make or model of device.
- Do not, under any circumstances, use another make or model of AC adapter other than the EH-72P Charging AC Adapter or USB-AC adapter. Failure to observe this precaution could result in overheating or in damage to the camera.
- The EH-72P is compatible with AC 100–240 V, 50/60 Hz electrical outlets. When using in other countries, use a plug adapter (commercially available) as necessary. For more information about plug adapters, consult your travel agency.
- The symbols on this product represent the following:  
~ AC, == DC,  Class II equipment (The construction of the product is double-insulated.)

# Cleaning and Storage

## Cleaning

Do not use alcohol, thinner, or other volatile chemicals.

Lens	Avoid touching glass parts with your fingers. Remove dust or lint with a blower (typically a small device with a rubber bulb attached to one end that is pumped to produce a stream of air out the other end). To remove fingerprints or other stains that cannot be removed with a blower, wipe the lens with a soft cloth, using a spiral motion that starts at the center of the lens and working toward the edges. If this fails, clean the lens using a cloth lightly dampened with commercial lens cleaner.
Monitor	Remove dust or lint with a blower. To remove fingerprints and other stains, clean the monitor with a soft, dry cloth, being careful not to apply pressure.
Body	Use a blower to remove dust, dirt, or sand, then wipe gently with a soft, dry cloth. After using the camera at the beach or other sandy or dusty environment, wipe off any sand, dust, or salt with a dry cloth lightly dampened with fresh water and dry thoroughly. <b>Note that foreign matter inside the camera could cause damage not covered by the warranty.</b>

## Storage

Remove the battery if the camera will not be used for an extended period. To prevent mold or mildew, take the camera out of storage at least once a month. Turn the camera on and release the shutter a few times before putting the camera away again. Do not store the camera in any of the following locations:

- Places that are poorly ventilated or subject to humidity of over 60%
- Exposed to temperatures above 50°C (122°F) or below -10°C (14°F)
- Next to equipment that produces strong electromagnetic fields, such as televisions or radios

For storing the battery, follow the precautions in “The Battery” (📖29) in “Caring for the Product” (📖28).

# Troubleshooting

If the camera fails to function as expected, check the list of common problems below before consulting your retailer or Nikon-authorized service representative.

Also, refer to the Reference Manual (PDF format) for further details on how to use this camera (📖ii).

Problem	Cause/Solution	📖
The camera is on but does not respond.	<ul style="list-style-type: none"> <li>• Wait for recording to end.</li> <li>• If the problem persists, turn the camera off. If the camera does not turn off, remove and reinsert the battery or batteries or, if you are using an AC adapter, disconnect and reconnect the AC adapter.</li> </ul> <p>Note that although any data currently being recorded will be lost, data that have already been recorded will not be affected by removing or disconnecting the power source.</p>	–
The camera cannot be turned on.	The battery is exhausted.	3, 4, 30
The camera turns off without warning.	<ul style="list-style-type: none"> <li>• The camera automatically turns off to save power (auto off function).</li> <li>• The camera and battery may not work properly at low temperatures.</li> <li>• The inside of the camera has become hot. Leave the camera off until the inside of the camera has cooled, and then try turning it on again.</li> </ul>	10 29 –
The monitor is blank.	<ul style="list-style-type: none"> <li>• The camera is off.</li> <li>• The camera automatically turns off to save power (auto off function).</li> <li>• The flash lamp flashes while the flash is charging. Wait until charging is complete.</li> <li>• The camera is connected to a TV or computer.</li> <li>• The camera and smart device are connected using a Wi-Fi connection and the camera is being operated by remote control.</li> </ul>	6 10 – – –
The camera becomes hot.	The camera may become hot when used for an extended period of time to shoot movies or when used in a hot environment; this is not a malfunction.	–



## Memory Cards That Can Be Used

The camera supports SD, SDHC, and SDXC memory cards.

- Memory cards with an SD Speed Class rating of 6 or faster are recommended for recording movies. When using a memory card with a lower Speed Class rating, movie recording may stop unexpectedly.
- If you use a card reader, make sure that it is compatible with your memory card.
- Contact the manufacturer for information on features, operation, and limitations on use.

---

## Trademark Information

- Windows is either a registered trademark or trademark of Microsoft Corporation in the United States and/or other countries.
- The *Bluetooth*® word mark and logos are registered trademarks owned by Bluetooth SIG, Inc. and any use of such marks by Nikon Corporation is under license.
- Apple®, App Store®, the Apple logos, Mac, OS X, macOS, iPhone®, iPad®, iPod touch® and iBooks are trademarks or registered trademarks of Apple Inc., in the U.S. and other countries.
- Android and Google Play are trademarks or registered trademarks of Google Inc. The Android robot is reproduced or modified from work created and shared by Google and used according to terms described in the Creative Commons 3.0 Attribution License.
- iOS is a trademark or registered trademark of Cisco Systems, Inc., in the United States and/or other countries and is used under license.
- Adobe, the Adobe logo, and Reader are either trademarks or registered trademarks of Adobe Systems Incorporated in the United States and/or other countries.
- SDXC, SDHC, and SD Logos are trademarks of SD-3C, LLC.



- PictBridge is a trademark.
- Wi-Fi and the Wi-Fi logo are trademarks or registered trademarks of the Wi-Fi Alliance.
- The N-Mark is a trademark or registered trademark of NFC Forum, Inc. in the United States and in other countries.

- All other trade names mentioned in this manual or the other documentation provided with your Nikon product are the trademarks or registered trademarks of their respective holders.

"Made for iPod," "Made for iPhone," and "Made for iPad" mean that an electronic accessory has been designed to connect specifically to iPod, iPhone, or iPad, respectively, and has been certified by the developer to meet Apple performance standards. Apple is not responsible for the operation of this device or its compliance with safety and regulatory standards. Please note that the use of this accessory with iPod, iPhone, or iPad may affect wireless performance.

## **AVC Patent Portfolio License**

This product is licensed under the AVC Patent Portfolio License for the personal and non-commercial use of a consumer to (i) encode video in compliance with the AVC standard ("AVC video") and/or (ii) decode AVC video that was encoded by a consumer engaged in a personal and non-commercial activity and/or was obtained from a video provider licensed to provide AVC video. No license is granted or shall be implied for any other use. Additional information may be obtained from MPEG LA, L.L.C.

See <http://www.mpegla.com>.

## **FreeType License (FreeType2)**

- Portions of this software are copyright © 2012 The FreeType Project (<http://www.freetype.org>). All rights reserved.

## **MIT License (HarfBuzz)**

- Portions of this software are copyright © 2016 The HarfBuzz Project (<http://www.freedesktop.org/wiki/Software/HarfBuzz>). All rights reserved.



No reproduction in any form of this manual, in whole or in part (except for brief quotation in critical articles or reviews), may be made without written authorization from NIKON CORPORATION.

**NIKON CORPORATION**

---

© 2016 Nikon Corporation



YP7K03(11)  
6MN71711-03