

Nikon



D6

Professional Setting Guide —Sports AF Edition— Revision 2.0



Table of Contents

Sports AF: Autofocus Basics	4
Autofocus Mode: AF-C.....	4
AF-Area Mode: 9-Point Dynamic-Area AF	4
Focus Tracking with Lock-On	4
Blocked Shot AF Response: [2]	4
Subject Motion: [Steady]	4
The Standby Timer	5
AF-Area Mode	6
Custom Focus Groups.....	8
Sports AF: Custom Settings	9
The D6 Versus the D5.....	9
a1: AF-C Priority Selection	10
a3: Focus Tracking with Lock-On.....	11
a4: Focus Points Used	11
a5: Store Points by Orientation.....	12
a6: AF Activation	13
a7: Single-Point AF Watch Area	14
a12: Auto-Area AF Starting Point.....	14
a13: Focus Point Persistence	15
a14: Limit AF-Area Mode Selection	17
a15: Autofocus Mode Restrictions	17
a16: Focus Point Wrap-Around	17
Sports AF: Custom Controls	18
Focus-Related Control Assignments.....	18
Lens Focus Function Buttons	19
AF Fine-Tuning	20
Manual Tuning	20
Auto AF Fine-Tuning	21
The Saved Values List	22
Focus Points	23
Cross Sensors	23
Teleconverters	24

Recommended AF Settings by Event	26
Overview: Settings by Event	26
Soccer	27
Gymnastics	27
Floor Exercises and Rhythmic Gymnastics	27
Balance Beam.....	28
Vault	28
Rings and Horizontal and Uneven Bars	28
Athletics	29
Sprints (Hand-Held, Single Runner, from the Front)	29
Hurdles	30
Sprints and Hurdles: Remote Photography	30
Marathons (from a Vehicle)	30
Shot Put, Discus, and Hammer Throw (from the Front, at a Distance)	31
Javelin (from the Front, at a Distance)	31
Long Jump and Triple Jump (Facing Oncoming Jumpers).....	31
High Jump.....	32
Pole Vault.....	32
Aquatics	33
Swimming	33
Diving	34
Artistic Swimming.....	34
Table Tennis.....	35
BMX and Skateboarding	35

Sports AF: Autofocus Basics

The following settings are suitable for most sports:

Autofocus mode	AF-C	
AF-area mode	9-point dynamic-area AF	
Custom Settings		
a1 AF-C priority selection	[Release]	
a3 Focus tracking with lock-on	Blocked shot AF response	[2]
	Subject motion	[Steady]
a15 Autofocus mode restrictions	[AF-C]	
c2 Standby timer	[1 min]	

Autofocus Mode: AF-C

The camera adjusts focus continuously while the AF-ON button is pressed or the shutter-release button is pressed halfway. The following indicators are displayed while the AF-mode button is pressed.

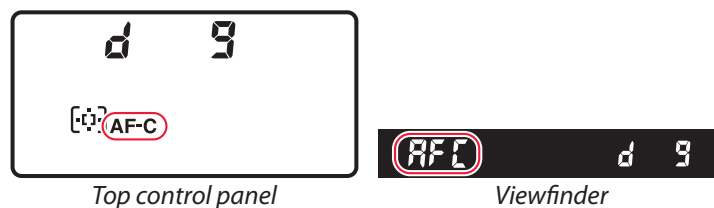

AF-Area Mode: 9-Point Dynamic-Area AF

If your subject briefly leaves the selected focus point, the camera will focus based on information from surrounding focus points. The following indicators are displayed while the AF-mode button is pressed.

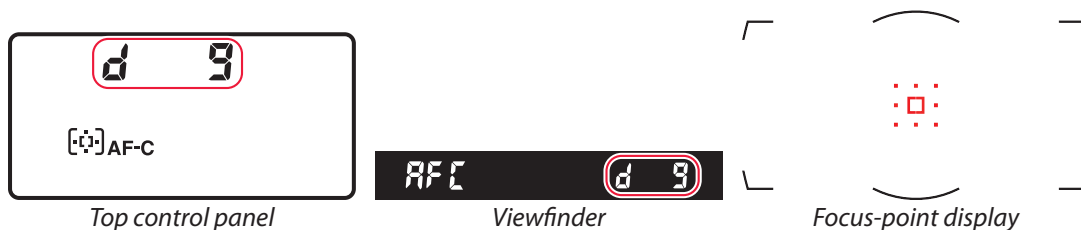

Focus Tracking with Lock-On

Custom Setting a3 [Focus tracking with lock-on] controls how autofocus responds to changes in the distance to the subject.

■ Blocked Shot AF Response: [2]

Increasing the speed with which the autofocus system reacts to blocked shots ensures that focus responds quickly to frequent subject changes.

■ Subject Motion: [Steady]

[Steady] is suited to a wide variety of subjects.

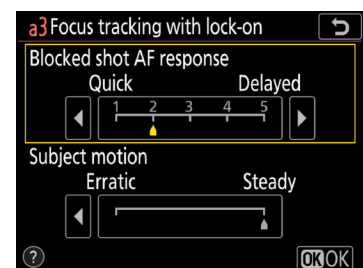

The Standby Timer

Choose long standby times to keep the timer active and avoid the delay in focusing that occurs when the timer is reactivated (note that this increases the drain on the battery). If you're at a soccer match and the default six-second timer expires while you're waiting for a player to line up a corner kick, you may miss the golden moment following the kick. In situations like these, we suggest setting Custom Setting c2 [Standby timer] to a minute or more.

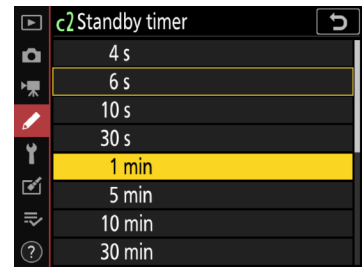

Face Detection

If you are shooting with 3D-tracking, group-area, or auto-area AF selected for AF-area mode, you have the option of enabling face detection to allow the camera to automatically detect and focus on faces. Face detection for these modes can be enabled by selecting [On] for Custom Setting a8 [3D-tracking face-detection], a9 [Group-area AF face detection], or a11 [Auto-area AF face detection].

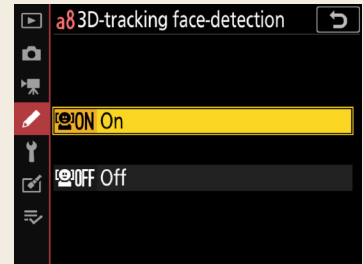

Recommended Settings by Event

See "[Recommended AF Settings by Event](#)" (page 26) for the recommended AF settings for different sporting events.

AF-Area Mode

Choose an AF-area mode according to your subject.

AF-area mode	Top control panel	Viewfinder	Focus-point display	
			Selection	Shooting
Single-point AF	S	S		
9-point dynamic-area AF	d 9	d 9		
25-point dynamic-area AF	d 25	d 25		
49-point dynamic-area AF	d 49	d 49		
105-point dynamic-area AF	d 105	d 105		
3D-tracking	3d	3d		
Group-area AF	G-P	G-P		
Group-area AF (C1)	G-P C1	G C1		
Group-area AF (C2)	G-P C2	G C2		
Auto-area AF	Auto	Auto		

■ Single-Point AF

In single-point AF, the focus point is selected manually and the camera focuses on the subject in the selected focus point only. Choose for subjects you can keep framed in the selected focus point. To focus on subjects not framed precisely in the chosen point, select [Wide] for Custom Setting a7 [Single-point AF watch area].

■ Dynamic-Area AF

In dynamic-area AF, the focus point is selected manually. The camera focuses on the subject in the selected focus point when autofocus is initiated, but if the subject later briefly leaves the selected point, the camera will focus based on information from surrounding points (during shooting, the edges of the area surrounding the selected focus point are shown by small dots, but all 9, 25, 49, or 105 focus points in the area are used for focus). Choose for low-contrast subjects if the camera has difficulty focusing, or for active subjects that are hard to keep framed in a single point, and increase the number of points if the subject is moving unpredictably or occupies a large area of the frame. Choose a setting one level higher for subjects at the edge of the frame.

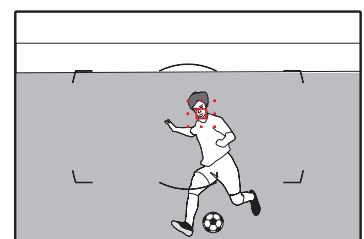

■ 3D-Tracking

In 3D-tracking, the initial focus point is selected manually. While the shutter-release button is pressed halfway, the camera uses color information to track subjects that leave the selected focus point and selects new focus points as required. Face detection can be enabled by selecting [On] for Custom Setting a8 [3D-tracking face-detection].

■ Group-Area AF

You choose the focus point, and the camera gives priority to the point containing the subject closest to the camera in an area that includes the selected point and surrounding focus points. The effective focus area is wider than that for single-point AF, reducing the risk of the camera focusing on the background. Choose for subjects that are difficult to photograph using a single focus point. Face detection can be enabled by selecting [On] for Custom Setting a9 [Group-area AF face detection].

■ Group-Area AF (C1/C2)

As for group-area AF, except that the vertical and horizontal dimensions of each of the two custom focus groups can be selected using the multi selector or Custom Setting a10 [Custom groupings (C1/C2)] ([page 8](#)). Custom focus groups are recommended if the size and shape of the area used for focus can be determined in advance with a fair degree of accuracy. Face detection can be enabled by selecting [On] for Custom Setting a9 [Group-area AF face detection].

■ Auto-Area AF

The camera automatically detects the subject and selects the focus point. Face detection can be enabled by selecting [On] for Custom Setting a11 [Auto-area AF face detection]. If you can predict the position of your subject in the frame with some degree of confidence, selecting [Enable] for Custom Setting a12 [Auto-area AF starting point] lets you choose the starting focus point when AF-C is selected for autofocus mode. The camera resumes normal auto-area AF after focusing on the subject in the selected point ([page 14](#)).

Custom Focus Groups

The vertical and horizontal dimensions of the custom focus groups for group-area AF (C1) and group-area AF (C2) can be selected using the AF-mode button and multi selector or via the Custom Settings menu.

■ The AF-Mode Button and Multi Selector

If a custom group-area AF option is currently selected for AF-area mode, you can choose the dimensions of the focus group by holding the AF-mode button and pressing the multi selector.

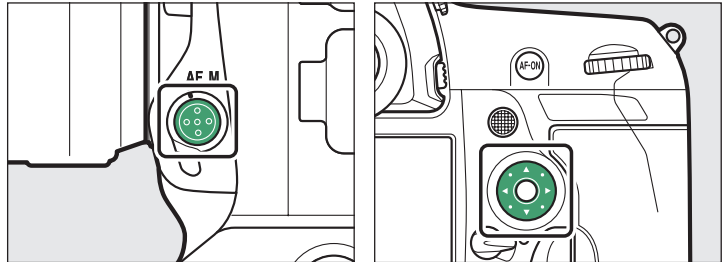

Width can be adjusted by pressing or and height by pressing or until the desired values are shown in the top control panel. The supported groupings are shown below.

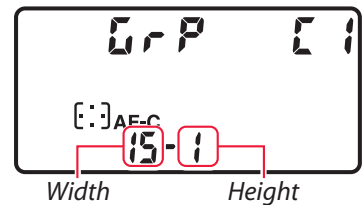
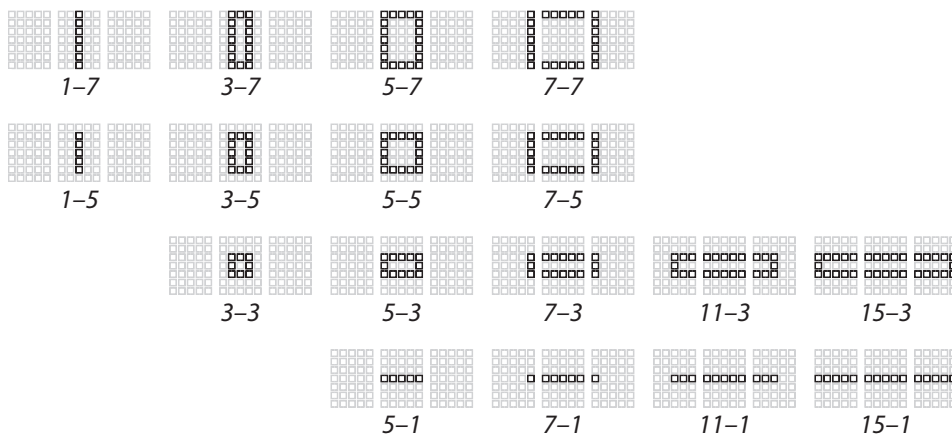

Custom groups can also be previewed in the viewfinder during selection.

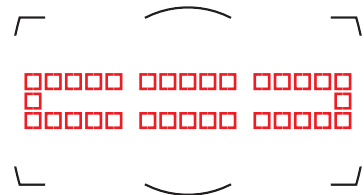

■ The Custom Settings Menu

Custom focus groups can also be sized using Custom Setting a10 [Custom groupings (C1/C2)]. Choose the desired custom mode, size the group using the multi selector, and press .

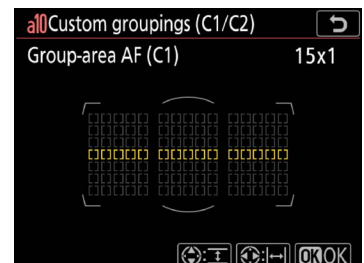

Sports AF: Custom Settings

Focus-related settings are found in Custom Settings Group “a” [Autofocus].

The D6 Versus the D5

Users of the D5 should note the differences between it and the D6 with respect to Custom Settings Group “a” [Autofocus].

D6	D5
a1 AF-C priority selection	a1 AF-C priority selection
a2 AF-S priority selection	a2 AF-S priority selection
a3 Focus tracking with lock-on	a3 Focus tracking with lock-on
a4 Focus points used	a4 3D-tracking face-detection
a5 Store points by orientation	a5 3D-tracking watch area
a6 AF activation	a6 Number of focus points
a7 Single-point AF watch area	a7 Store by orientation
a8 3D-tracking face-detection	a8 AF activation
a9 Group-area AF face detection	a9 Limit AF-area mode selection
a10 Custom groupings (C1/C2)	a10 Autofocus mode restrictions
a11 Auto-area AF face detection	a11 Focus point wrap-around
a12 Auto-area AF starting point	a12 Focus point options
a13 Focus point persistence	
a14 Limit AF-area mode selection	
a15 Autofocus mode restrictions	
a16 Focus point wrap-around	
a17 Focus point options	
a18 Manual focus ring in AF mode	

The D6 features seven new Custom Settings:

- a7 [Single-point AF watch area] ([page 14](#)),
- a9 [Group-area AF face detection] ([page 7](#)),
- a10 [Custom groupings (C1/C2)] ([page 8](#)),
- a11 [Auto-area AF face detection] ([page 7](#)),
- a12 [Auto-area AF starting point] ([page 14](#)),
- a13 [Focus point persistence] ([page 15](#)), and
- a18 [Manual focus ring in AF mode].

The former a6 [Number of focus points] is now a4 [Focus points used], and the options available have changed to reflect the change in the number of focus points. The former a7 [Store by orientation] is now a5 [Store points by orientation], replacing the former a5 [3D-tracking watch area], which is no longer available.

a1: AF-C Priority Selection

Custom Setting a1 [AF-C priority selection] controls whether the camera gives priority to focus or shutter release.

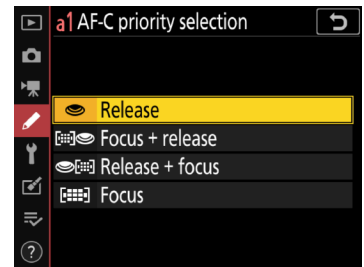

Shutter-release button pressed all the way down



Subject not in focus
 Subject in focus
 Photo taken (frame number shown in top left corner)

Release: Pictures can be taken whether or not the camera is in focus. Frame rates do not slow during burst photography.

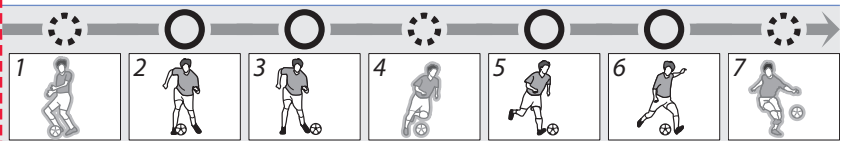

Focus + release: In burst mode, priority is given to focus for the first frame and to release for later frames, ensuring that the first frame is in focus and that no subsequent frames are missed. Frame rates do not slow.

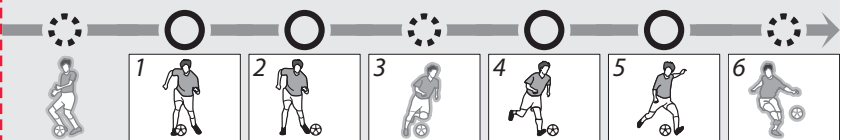

Release + focus: In burst mode, priority is given to release for the first frame and to focus for later frames. Frame rates slow as needed to allow the camera to focus.

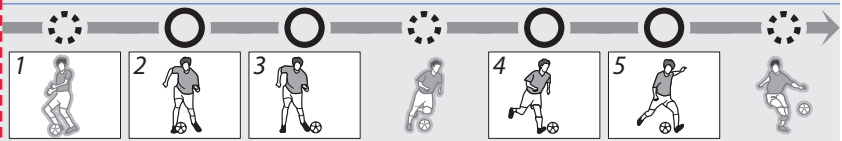

Focus: Pictures can only be taken when the camera is in focus.

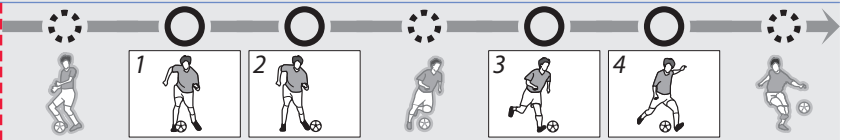

Note: Release timing not exactly as shown.

a3: Focus Tracking with Lock-On

This menu contains two options: [Blocked Shot AF Response] and [Subject motion].

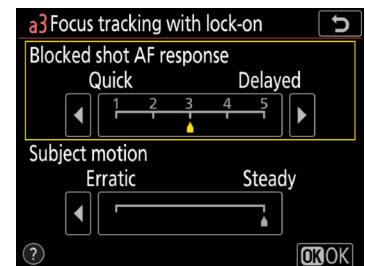

■ Blocked Shot AF Response

If AF-C is selected for AF mode, focus tracking with lock-on will prevent the camera refocusing when your subject is briefly obscured by another object, ensuring that it will continue to track the main subject once the obstacle has moved away. Choose the length of time before the camera refocuses from [1 (Quick)], [2], [3], [4], and [5 (Delayed)]. Lock-on applies only while the camera is focusing; to focus at a new distance without waiting for lock-on to end, re-initiate autofocus.

The camera will track and focus on objects at the same distance as the main subject. High values (slow response) make the camera slow to re-focus on obstacles when the shot is blocked. Select low values (quick response) to quickly refocus on subjects passing in front of the camera and for improved response when switching rapidly from one subject to another.

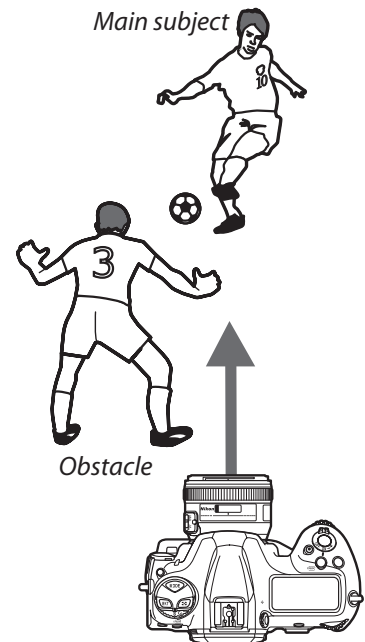

■ Subject Motion

Choose how the camera tracks subjects in motion. Choose [Steady] for subjects approaching the camera at a steady pace, like sprinters or race cars on a track, [Erratic] for long or triple jumpers and other subjects prone to sudden stops and starts.

a4: Focus Points Used

Choose number of focus points available for manual focus-point selection from the options below. Choosing [27 points] or [15 points] speeds focus-point selection.

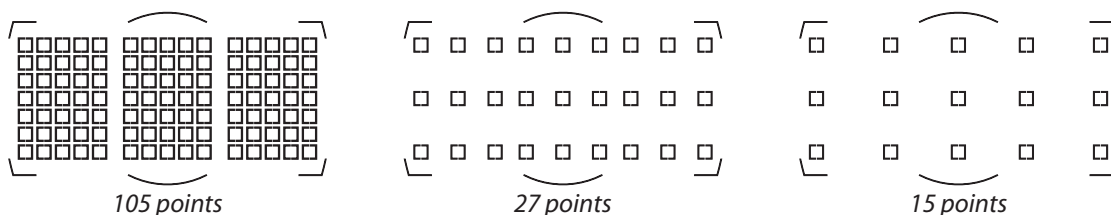

Note that the groupings available when [Group-area AF (C1)] or [Group-area AF(C2)] is chosen for AF-area mode vary with the dimensions of the group.

a5: Store Points by Orientation

This option lets you concentrate on shooting without having to worry about focus-point selection. Choose whether the camera uses the same focus point and AF-area mode in all orientations, or stores separate focus points and/or AF-area modes for use in “wide” (landscape) orientation, “tall” (portrait) orientation with the camera rotated 90° clockwise, or “tall” orientation with the camera rotated 90° counterclockwise. The options are [Focus point], [Focus point and AF-area mode], and [Off].

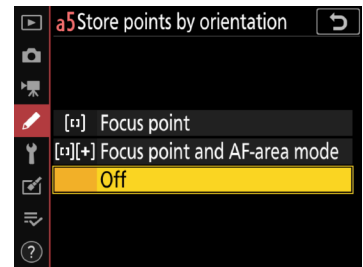

- [Focus point]: Rotating the camera restores the focus point last selected in the chosen orientation. If you select [Off] after choosing this option, the camera will select the center focus point for all orientations.

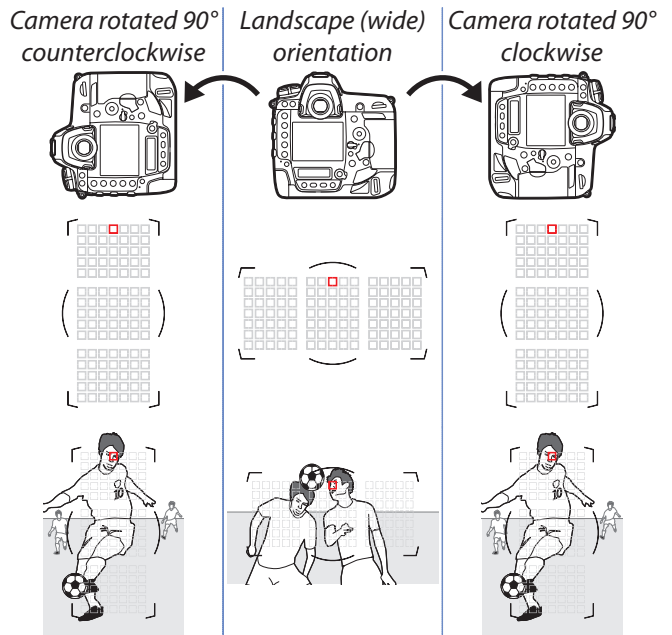

- [Focus point and AF-area mode]: Rotating the camera restores the focus point and AF-area mode last selected in the chosen orientation. In the example shown here, 9-point dynamic-area AF is selected when the camera is in landscape orientation, 3D-tracking when it is rotated 90° counterclockwise, and group-area AF when it is rotated 90° clockwise.

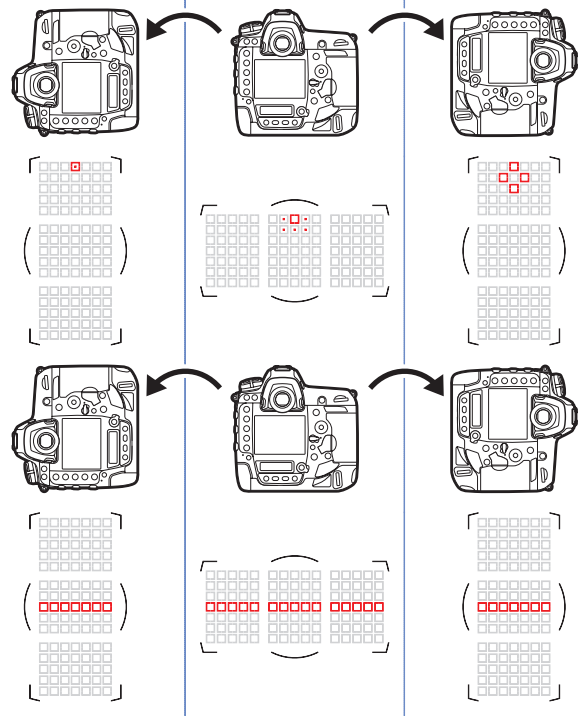

If you select a group with a single row of focus points (15 × 1) for group-area AF (C1) when the camera is in landscape orientation and groups with a single column of focus points (1 × 7) for group-area AF (C2) when the camera is in portrait orientation, the camera will consistently focus on subjects in a line across the frame.

- [Off]: The same focus point and AF-area mode will be used regardless of camera orientation.

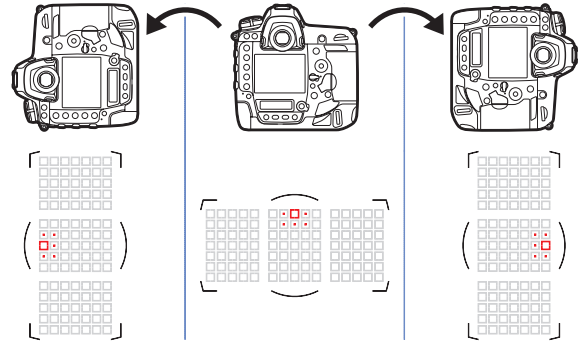

a6: AF Activation

Choose [AF-ON only] to split the functions of the **AF-ON** button (or the control to which [AF-ON] has been assigned using Custom Setting f3 [Custom Controls]) and the shutter-release button so that the former is used for focus while the latter is used only to release the shutter. Lift your thumb from the **AF-ON** button to lock focus and take more shots at the current focus distance or prevent the camera refocusing when an object passes between you and your subject.

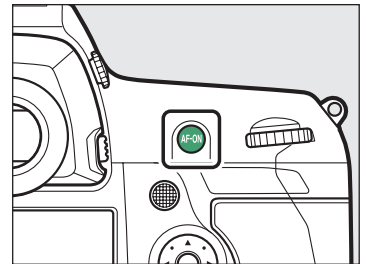

Highlighting [AF-ON only] and pressing  displays an [Out-of-focus release] option; for sports photography, confirm that [Enable] is selected.

The Lens Focus Function Selector

When the lens focus function selector available with certain telephoto lenses ([page 19](#)) is in the **AF-ON** position, the lens focus function buttons will perform the same function as the camera **AF-ON** button.

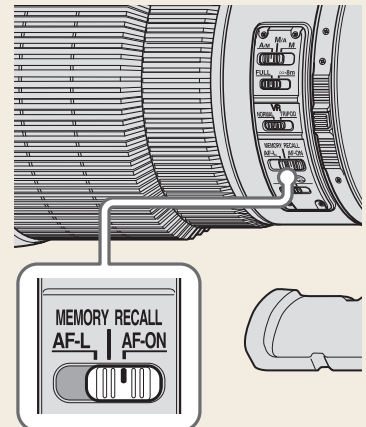

a7: Single-Point AF Watch Area

If [Wide] is selected in single-point or dynamic-area AF AF-area mode, the camera will use data from surrounding areas to locate subjects slightly outside the selected focus point. Use for fast-moving, hard-to-frame subjects.

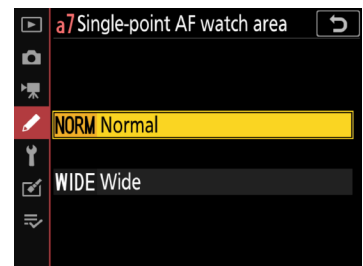

a12: Auto-Area AF Starting Point

Selecting [Enable] lets you use the multi selector to choose the starting focus point when AF-C and auto-area AF are selected respectively for AF mode and AF-area mode. The camera will resume normal auto-area AF after focusing on the subject in the selected point.

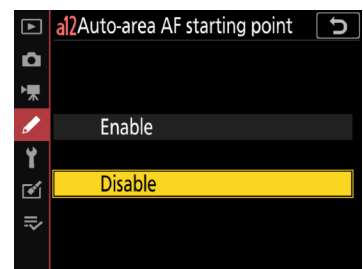

By default, auto-area AF will automatically focus on the subject closest to the camera, and consequently when photographing subjects that appear briefly at a fixed location—for example, passing the starting line or jumping off a ramp—you may find that the camera fails to focus as desired. Enabling [Auto-area AF starting point], framing the shot in advance, and choosing a focus point where you anticipate your subject will appear ensures that focus will start from the selected point, helping keep your shots in focus.

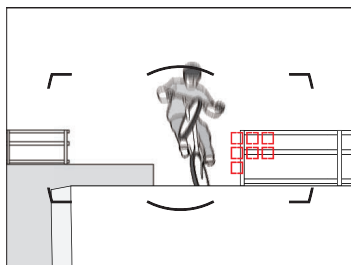

When [Disable] is selected, the camera may focus on foreground objects.

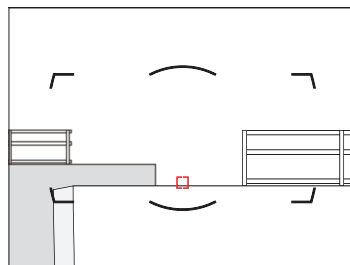

Selecting [Enable] lets you choose the focus point before shooting. The focus operation will start from the selected point, helping ensure your shots are in focus.

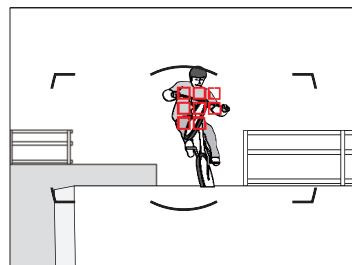

For more information on using [Auto-area AF starting point], view the video at the link below.

[YouTube | Digitutor](#)

D6 NPS #2. Nimble Focusing Using the Auto-area AF Starting Point Function

a13: Focus Point Persistence

If you have assigned [AF-area mode] or [AF-area mode + AF-ON] to a control using Custom Setting f3 [Custom controls], you can hold the control to switch temporarily from the current AF-area mode to a second, pre-selected mode. Selecting [Auto] for Custom Setting a13 [Focus point persistence] lets you do so without changing focus points.

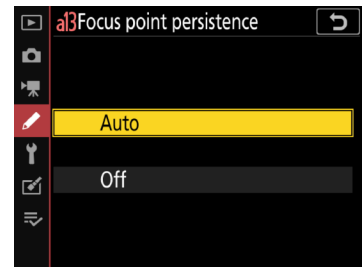

■ Using Focus-Point Persistence: An Example

In this example, we will assign [AF-area mode] to the Fn1 button and hold it to switch temporarily from the current AF-area mode (auto-area AF in this case) to a second, pre-selected mode (here 9-point dynamic-area AF).

1 Enable focus-point persistence.

Select [Auto] for Custom Setting a13 [Focus point persistence].

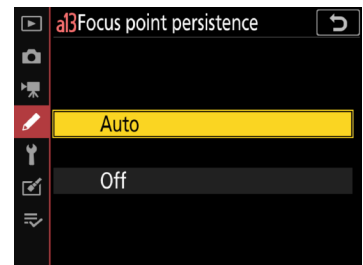

2 Select the default AF-area mode.

For this example we will choose [Auto-area AF] and an autofocus mode of AF-C.

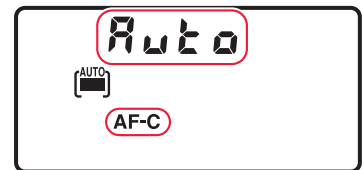

3 Assign [AF-area mode] or [AF-area mode + AF-ON] to a control.

Select Custom Setting f3 [Custom controls] and choose the desired control and role (in this case, the Fn1 button and [AF-area mode]). To choose the AF-area mode activated while the button is pressed, highlight [AF-area mode] and press . This example assumes that [Dynamic-area AF (9 points)] is selected.

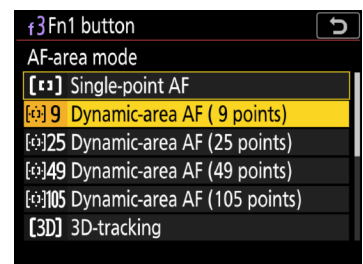

4 Focus using the default AF-area mode.

Press the shutter-release button halfway or press the **AF-ON** button to focus using the default AF-area mode. In the case of auto-area AF, the camera will automatically detect the subject and choose the focus area.

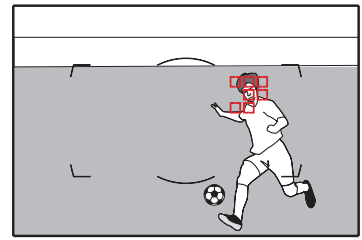

At the settings selected in this example, focus will track subject motion while the shutter-release button is pressed halfway or the **AF-ON** button is pressed.

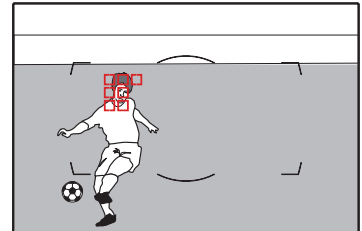

5 Switch AF-area modes.

Hold the selected control (the **Fn1** button) to switch to the AF-area mode selected in Step 3 (9-point dynamic-area AF). Because we selected [**Auto**] for Custom Setting a13 [**Focus point persistence**] in Step 1, the camera will focus on the subject in the current focus point using 9-point dynamic-area AF.

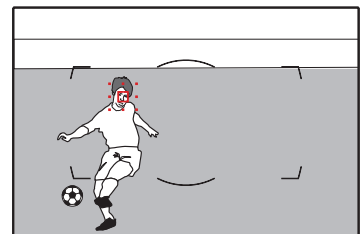

Had we selected [**Off**], the camera would not have maintained focus on the subject in the point chosen by auto-area AF but would have instead switched to a different focus point.

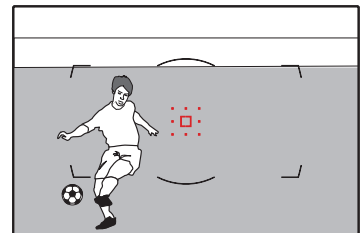

a14: Limit AF-Area Mode Selection

Limiting the choice of AF-area modes available during viewfinder photography speeds AF-area mode selection and prevents your accidentally selecting an undesired option. For example, you can limit the choice of AF-area modes to single-point and 25-point dynamic-area AF by selecting only these options in the AF-area mode list. Note that [Single-point AF] cannot be deselected.

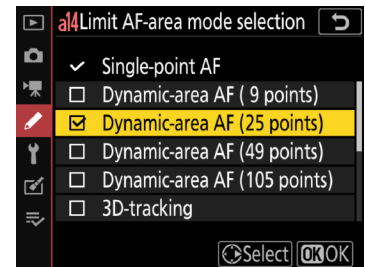

a15: Autofocus Mode Restrictions

Limiting the choice of available autofocus modes prevents accidental selection of an undesired option. For sports photography, you may find it convenient to choose [AF-C] to stop you accidentally selecting AF-S.

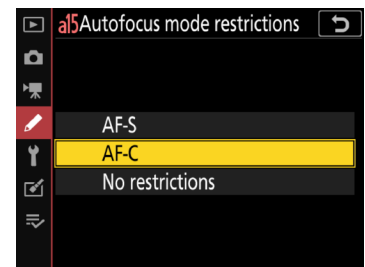

a16: Focus Point Wrap-Around

Select [Wrap] if you frequently switch between widely-separated focus points.

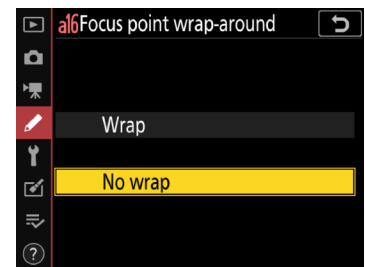

Focus-point selection will “wrap around” from top to bottom, bottom to top, left to right, and right to left so that, for example, pressing  when a focus point on the right edge of the display is highlighted (①) selects the corresponding focus point on the left edge of the display (②).

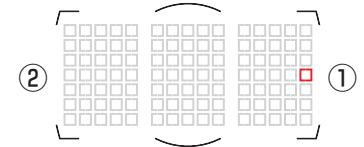

Sports AF: Custom Controls

Custom Setting f3 [Custom controls] can be used to assign different roles, including focus-related functions, to camera controls such as the Fn buttons and the Pv button.

Focus-Related Control Assignments

Camera controls can be assigned the following focus-related functions:

	Pv	Fn1	Fn2	Fn (vertical)	Fn3	AF-ON	Sub-selector	Sub-selector center	AF-ON (vertical)	Multi-selector (vertical)	Metering + Cmd	BKT + Cmd	Movie-record	L-Fn
PRE Preset focus point	✓	✓	✓	✓	—	—	—	✓	—	—	—	—	—	✓
[] AF-area mode	✓	✓	✓	—	—	✓	—	✓	✓	—	—	—	—	✓
[] AF-area mode + AF-ON	✓	✓	✓	—	—	✓	—	✓	✓	—	—	—	—	✓
AF-ON AF-ON	✓	✓	✓	—	—	✓	—	✓	✓	—	—	—	—	✓
AF AF lock only	✓	✓	✓	—	—	✓	—	✓	✓	—	—	—	—	✓
AE/AF AE/AF lock	✓	✓	✓	—	—	✓	—	✓	✓	—	—	—	—	✓
RESET Select center focus point	—	—	—	—	—	—	—	✓	—	—	—	—	—	—
AF/[+] AF mode/AF-area mode	✓	✓	✓	✓	—	—	—	—	—	—	—	—	—	✓
= Same as multi selector	—	—	—	—	—	—	✓	—	—	✓	—	—	—	—
[] Focus point selection	—	—	—	—	—	—	✓	—	—	✓	—	—	—	—

Legend: Pv = Pv button, Fn1 = Fn1 button, Fn2 = Fn2 button, Fn (vertical) = Fn button for vertical shooting, Fn3 = Fn3 button, AF-ON = AF-ON button, Sub-selector = sub-selector, Sub-selector center = sub-selector center button, AF-ON (vertical) = AF-ON button for vertical shooting, Multi-selector (vertical) = multi selector for vertical shooting, Metering + Cmd = metering button + command dials, BKT + Cmd = BKT button + command dials, Movie-record = movie-record button, L-Fn = lens Fn button

These functions are described below.

- **PRE Preset focus point:** Pressing the control selects a preset focus point. To choose the point, highlight it and hold the control while pressing the AF-mode button; the focus point will flash when the operation is complete. If an option other than [Off] is selected for Custom Setting a5 [Store points by orientation], you can choose separate focus points for “wide” (landscape) orientation and each of the two “tall” (portrait) orientations. Pressing [] when [Preset focus point] is highlighted displays a sub-menu where you can choose how the control behaves:
 - [Press to recall focus point]: Pressing the control selects the preset focus point.
 - [Hold to recall focus point]: The camera switches to the preset focus point only while the control is pressed and restores the previously-selected point when the control is released.
- [] **AF-area mode:** Highlight this option and press [] to select an AF-area mode. The selected mode will take effect while the control is pressed; releasing the control restores the original AF-area mode.
- [] **AF-area mode + AF-ON:** As for [AF-area mode], except that pressing the control also initiates autofocus.
- **AF-ON AF-ON:** The control performs the role normally performed by the AF-ON button. Pressing the control initiates autofocus.
- **AF AF lock only:** Focus locks while the control is pressed.
- **AE/AF AE/AF lock:** Focus and exposure lock while the control is pressed.
- **RESET Select center focus point:** Pressing the control selects the center focus point.
- **AF/[+] AF mode/AF-area mode:** The control performs the role normally performed by the AF-mode button. Hold the control and rotate the main command dial to choose the autofocus mode, the sub-command dial to choose the AF-area mode.
- **= Same as multi selector:** This role can be assigned to the sub-selector or the multi selector for vertical shooting, which then be pressed up, down, left, and right to mimic pressing [], [], [], and [] on the multi selector. The center of the multi selector for vertical shooting will also perform the same role as the center of the multi selector. The role of the control during playback can be chosen from [Scroll] and [Display next/previous frame] in the case of the sub-selector, or using [Photo info/playback] in the case of the multi selector for vertical shooting. If [Info /Playback] is selected, you can press the multi selector for vertical shooting up or down to display other pictures, left or right to view photo info.

- [Fn] **Focus point selection:** The control can be used to choose the focus point. If this role is assigned to the multi selector for vertical shooting, the center of the control will perform the role currently chosen for [Sub-selector center].

Lens Focus Function Buttons

You can use [Fn] **Lens focus function buttons** to choose the role played by the focus function buttons when the focus function selector on the lens is set to **AF-L**. For fast-moving sports, choose [AF-area mode] to enable rapid AF-area mode selection.

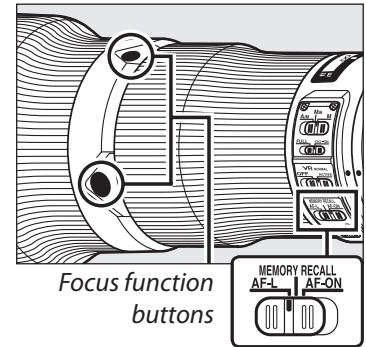

Lenses with Focus Function Selectors

As of March, 2020, the following lenses are equipped with a focus function selector:

- AF-S NIKKOR 800mm f/5.6E FL ED VR
- AF-S NIKKOR 600mm f/4G ED VR
- AF-S NIKKOR 600mm f/4E FL ED VR
- AF-S NIKKOR 500mm f/4G ED VR
- AF-S NIKKOR 500mm f/4E FL ED VR
- AF-S NIKKOR 500mm f/5.6E PF ED VR
- AF-S NIKKOR 400mm f/2.8G ED VR
- AF-S NIKKOR 400mm f/2.8E FL ED VR
- AF-S NIKKOR 300mm f/2.8G ED VR II
- AF-S NIKKOR 200mm f/2G ED VR II
- AF-S NIKKOR 70–200mm f/2.8E FL ED VR
- AF-S NIKKOR 120–300mm f/2.8E FL ED SR VR
- AF-S NIKKOR 180–400mm f/4E TC1.4 FL ED VR
- AF-S NIKKOR 200–400mm f/4G ED VR II

AF Fine-Tuning

When a CPU lens is mounted on the camera, autofocus can be manually or (in live view) automatically fine-tuned to suit your preferences. In the case of zoom lenses, the camera can store two fine-tuning values for each lens: one for use when the lens is zoomed all the way out (WIDE) and another for when it is zoomed all the way in (TELE).

AF Fine-Tuning

Use only as required. AF fine-tuning should be performed at the focus distance at which the lens is normally used; fine-tuning performed at short focus distances may be less effective with distant subjects and *vice versa*. The saved values are applied only during viewfinder photography and do not take effect in live view.

Manual Tuning

To fine-tune autofocus for the current lens, select [AF fine-tuning options] > [Fine-tune and save lens] in the setup menu. Any previously-saved value for the current lens will be overwritten.

1 Select [Fine-tune and save lens].

In the setup menu, select [AF fine-tuning options], then highlight [Fine-tune and save lens] and press to display the AF fine-tuning dialog. The options displayed vary with the type of lens.

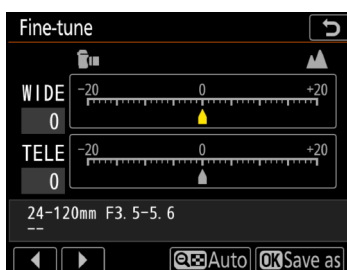

Zoom lenses

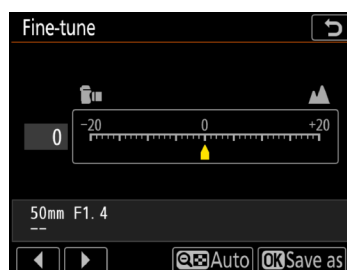

Fixed focal-length (prime) lenses

2 Fine-tune autofocus.

Press or to choose from values of +20 to -20, selecting low values to move the focus point toward the camera and high values to move it away. The value currently-selected is shown by ▲, the last saved value for the lens by △. In the case of zoom lenses, you can save two fine-tuning values: one for use when the lens is zoomed all the way out (WIDE) and another for when it is zoomed all the way in (TELE). Press or to access the desired option.

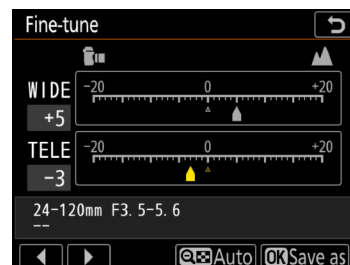

If desired, you can press to end manual tuning and proceed to Step 3 of “Auto AF Fine-Tuning” (page 21), where you can fine-tune autofocus automatically while previewing the results in live view display.

3 Press .

Press to save the new value. To enable AF fine-tuning during shooting, select [On] for [AF fine-tuning options] > [AF fine-tune on/off] in the setup menu.

Auto AF Fine-Tuning

To fine-tune autofocus automatically while previewing the results in live view:

1 Ready the camera.

Mount the camera on a tripod and aim it at a flat, high-contrast subject parallel to the camera focal plane. Note that auto AF fine-tuning works best at maximum aperture and may not function in dark surroundings.

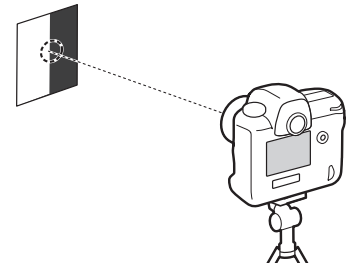

2 Start live view.

Rotate the live view selector to and press the button.

3 Start auto AF fine-tuning.

Press the AF-mode and movie-record buttons and keep them pressed until fine-tuning options are displayed.

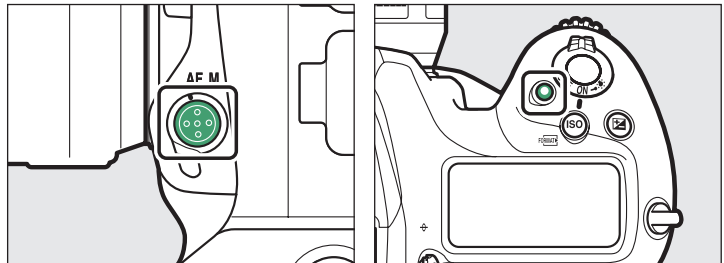

Zoom lenses: If the current lens is a zoom lens, you will be prompted to choose two separate values, one for use when the lens is zoomed all the way out (WIDE) and another for when it is zoomed all the way in (TELE). Highlight [WIDE] or [TELE] and press to display the fine-tuning dialog with the center focus point selected. Before proceeding to Step 4, rotate the zoom ring to zoom all the way out (WIDE) or all the way in (TELE) according to the option selected.

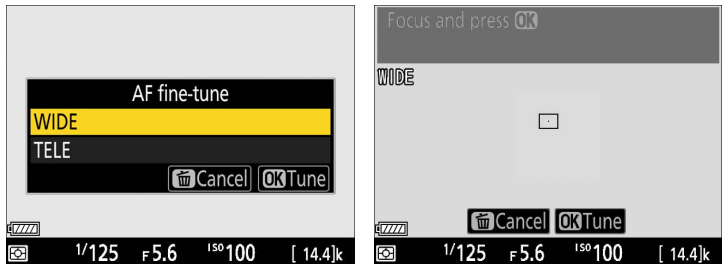

Fixed focal-length (prime) lenses: If the current lens is a prime lens, the camera will display the fine-tuning dialog with the center focus point selected.

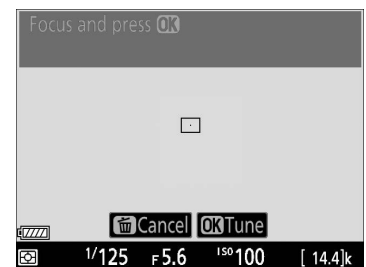

Previously-Saved Values

If a saved value already exists for the current lens, you will be prompted to either overwrite the existing value or to save the new value under a different name.

4 Focus.

Press the shutter-release button halfway to focus, then zoom in on the view through the lens to confirm that focus is accurate. Focus can be adjusted manually if necessary.

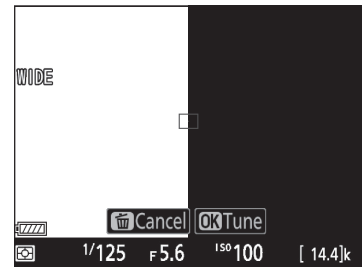

5 Press \odot .

If fine-tuning is successful, the new AF fine-tuning value for the current lens will be added to the [List save values] list and [On] will automatically be selected for [AF fine-tune on/off], enabling AF fine-tuning.

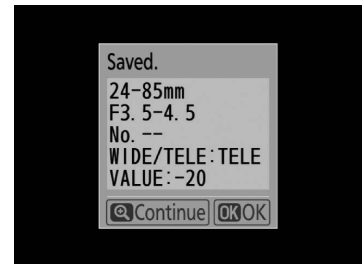

After completing AF fine-tuning for either the maximum angle or maximum zoom, press the \odot button and choose the remaining zoom position ([WIDE] or [TELE]). Repeat Steps 4 and 5 to complete auto fine-tuning for the selected item.

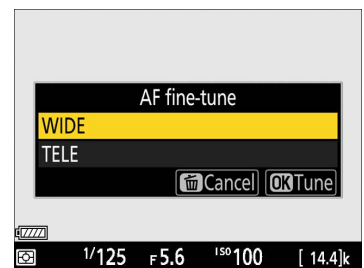

6 Exit the fine-tuning dialog.

Press \odot to exit the fine-tuning dialog.

The Saved Values List

To view previously-saved fine-tuning values, select [AF fine-tuning options] > [List saved values] in the setup menu. The camera can store values for up to 40 lenses. To help distinguish between multiple lenses of the same type, each lens can be assigned a unique identifier—for example, the last two digits of the lens serial number—by highlighting the lens in the list, pressing \odot , and choosing the desired identifier in the [Choose lens number] dialog.

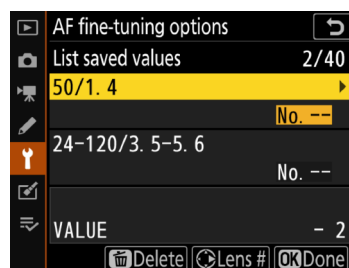

Saved values list

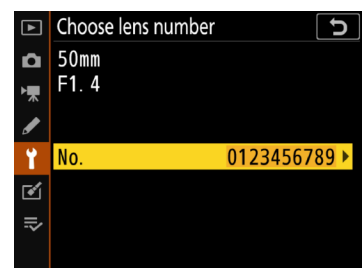

Choose lens number dialog

To delete a saved value when it is no longer needed, highlight the lens in the list and press \odot .

Focus Points

While normally a total of 105 focus points are available during viewfinder photography, the number of cross sensors and the focus points available for autofocus and electronic rangefinding may vary according to the lens or teleconverter attached.

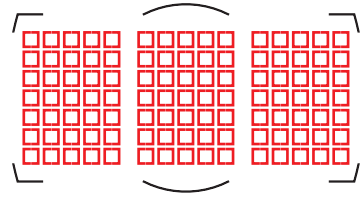

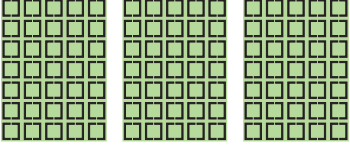
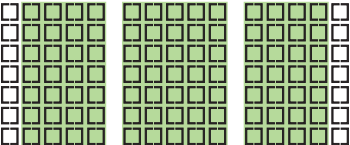
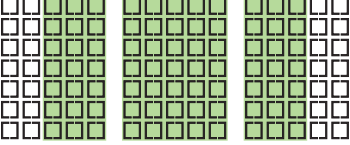
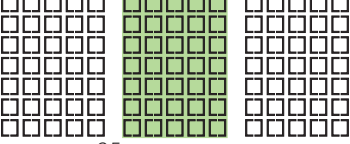

Cross Sensors

The availability of cross-sensor focus points varies with the lens used. Cross sensors are used for the focus points shown in green, while the remainder use line sensors.

Lens	Cross sensors
AF-S and AF-P lenses with maximum apertures (at maximum zoom, if applicable) of f/4 or faster, excluding the lenses listed below.	 <p>105 cross sensors</p>
<ul style="list-style-type: none"> • AF-S DX Zoom-Nikkor 12–24mm f/4G IF-ED • AF-S NIKKOR 500mm f/4E FL ED VR • AF-S NIKKOR 600mm f/4G ED VR • AF-S NIKKOR 600mm f/4E FL ED VR • AF-S Nikkor 600mm f/4D IF-ED II • AF-S Nikkor 600mm f/4D IF-ED 	 <p>91 cross sensors</p>
<ul style="list-style-type: none"> • AF-S NIKKOR 500mm f/4G ED VR • AF-S Nikkor 500mm f/4D IF-ED II • AF-S Nikkor 500mm f/4D IF-ED 	 <p>77 cross sensors</p>
<ul style="list-style-type: none"> • AF-S NIKKOR 200–400mm f/4G ED VR II • AF-S VR Zoom-Nikkor 200–400mm f/4G IF-ED • AF-S and AF-P lenses with maximum apertures (at maximum zoom, if applicable) slower than f/4 • Non-AF-S, non-AF-P lenses 	 <p>35 cross sensors</p>

Teleconverters

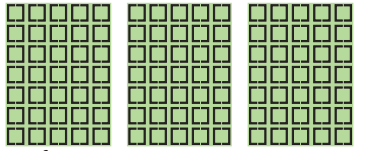
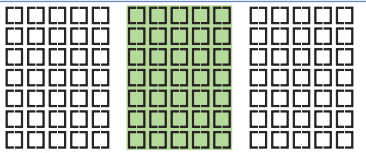
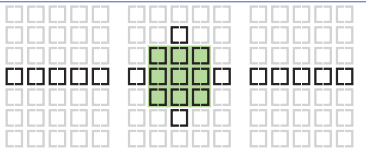
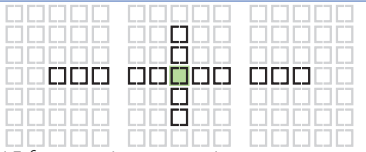
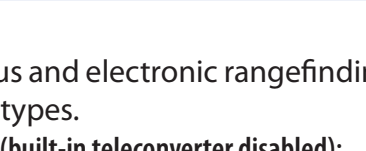

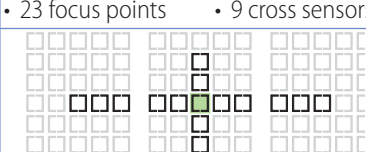
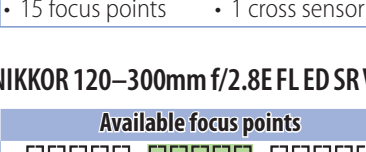
The focus points available for autofocus and electronic rangefinding when an AF-S or AF-P teleconverter is attached are shown below. Cross sensors are used for the focus points shown in green, while the remainder use line sensors. Note that at maximum combined apertures slower than f/5.6, the camera may not be able to focus on dark or low-contrast subjects. Autofocus is not available when teleconverters are used with AF-S VR Micro-Nikkor 105mm f/2.8G IF-ED lenses.

Teleconverter	Maximum aperture of lens*	Available focus points
<ul style="list-style-type: none"> • TC-14E, TC-14E II, TC-14E III • TC-17E II • TC-20E, TC-20E II, TC-20E III 	f/2	 <ul style="list-style-type: none"> • 105 focus points • 105 cross sensors
TC-14E, TC-14E II, TC-14E III	f/2.8	 <ul style="list-style-type: none"> • 105 focus points • 35 cross sensors
<ul style="list-style-type: none"> • TC-17E II • TC-20E, TC-20E II, TC-20E III 	f/2.8	 <ul style="list-style-type: none"> • 105 focus points • 35 cross sensors
TC-14E, TC-14E II, TC-14E III	f/4	 <ul style="list-style-type: none"> • 105 focus points • 35 cross sensors
TC-17E II	f/4	 <ul style="list-style-type: none"> • 23 focus points • 9 cross sensors
TC-800-1.25E ED	f/5.6	 <ul style="list-style-type: none"> • 15 focus points • 1 cross sensor
TC-20E, TC-20E II, TC-20E III	f/4	 <ul style="list-style-type: none"> • 15 focus points • 1 cross sensor
TC-14E, TC-14E II, TC-14E III	f/5.6	 <ul style="list-style-type: none"> • 15 focus points • 1 cross sensor

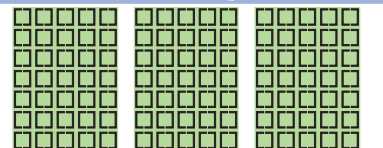
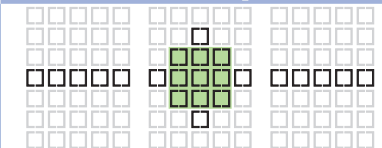

* At maximum zoom, in the case of zoom lenses.

The following illustrations show the focus points available for autofocus and electronic rangefinding when teleconverters are used in combination with lenses of different types.

● **AF-S NIKKOR 300mm f/4E PF ED VR and AF-S NIKKOR 180–400mm f/4E TC1.4 FL ED VR (built-in teleconverter disabled):**

Used	Available focus points	Used	Available focus points
Alone	 <ul style="list-style-type: none"> • 105 focus points • 105 cross sensors 	With a TC-17E II	 <ul style="list-style-type: none"> • 23 focus points • 9 cross sensors
With a TC-14E, TC-14E II, or TC-14E III	 <ul style="list-style-type: none"> • 105 focus points • 35 cross sensors 	With a TC-20E, TC-20E II, or TC-20E III	 <ul style="list-style-type: none"> • 15 focus points • 1 cross sensor

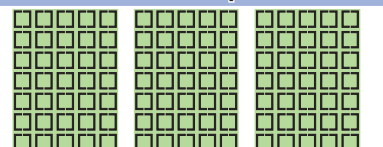
● **AF-S NIKKOR 400mm f/2.8E FL ED VR, AF-S NIKKOR 70–200mm f/2.8G ED VR II, and AF-S NIKKOR 120–300mm f/2.8E FL ED SR VR:**

Used	Available focus points	Used	Available focus points
<ul style="list-style-type: none"> • Alone • With a TC-14E, TC-14E II, or TC-14E III 	 <ul style="list-style-type: none"> • 105 focus points • 105 cross sensors 	<ul style="list-style-type: none"> • With a TC-17E II • With a TC-20E, TC-20E II, or TC-20E III 	 <ul style="list-style-type: none"> • 105 focus points • 35 cross sensors

● AF-S NIKKOR 500mm f/4E FL ED VR and AF-S NIKKOR 600mm f/4E FL ED VR:

Used	Available focus points	Used	Available focus points
Alone	<p>• 105 focus points • 91 cross sensors</p>	With a TC-17E II	<p>• 23 focus points • 9 cross sensors</p>
With a TC-14E, TC-14E II, or TC-14E III	<p>• 105 focus points • 35 cross sensors</p>	With a TC-20E, TC-20E II, or TC-20E III	<p>• 15 focus points • 1 cross sensor</p>

● AF-S NIKKOR 500mm f/5.6E PF ED VR, AF-S NIKKOR 80–400mm f/4.5–5.6G ED VR, AF-S NIKKOR 180–400mm f/4E TC1.4 FL ED VR (built-in teleconverter enabled), and AF-S NIKKOR 200–500mm f/5.6E ED VR:

Used	Available focus points	Used	Available focus points
Alone	<p>• 105 focus points • 35 cross sensors</p>	With a TC-14E, TC-14E II, or TC-14E III	<p>• 15 focus points • 1 cross sensor</p>

● AF-S NIKKOR 200–400mm f/4G ED VR II:

Used	Available focus points	Used	Available focus points
<ul style="list-style-type: none"> • Alone • With a TC-14E, TC-14E II, or TC-14E III 	<p>• 105 focus points • 35 cross sensors</p>	With a TC-17E II	<p>• 23 focus points • 9 cross sensors</p>
		With a TC-20E, TC-20E II, or TC-20E III	<p>• 15 focus points • 1 cross sensor</p>

Recommended AF Settings by Event

This section offers some advice on adjusting autofocus-related settings for different sporting events.

Overview: Settings by Event

The settings for different events are summarized in the table below. For all events listed, we recommend that you select an autofocus mode of **AF-C**, choose **[Release]** for Custom Setting a1 **[AF-C priority selection]**, and use Custom Setting a8 **[3D-tracking face-detection]**, a9 **[Group-area AF face detection]**, or a11 **[Auto-area AF face detection]** to enable face detection in the AF-area modes in which it is available.

Event	AF-area mode	Custom settings					
		a3		a5	a7	a12	
		Blocked shot AF response	Subject motion				
Soccer (page 27)	9-point dynamic-area AF	2		Focus point	Normal		
Gymnastics	Floor exercises, rhythmic gymnastics (page 27)	Auto-area AF	3	Steady	—	—	
	Balance beam (page 28)	• Wide: group-area AF (C1), 15 × 3 • Tall: group-area AF (C2), 7 × 7			Focus point and AF-area mode		—
	Vault (page 28)	Auto-area AF		Erratic	—	—	Enable
	Rings and horizontal and uneven bars (page 28)	3D-tracking					
Athletics	Sprints (hand-held shots focusing on a single runner approaching the camera, page 29)	9-point dynamic-area AF	3	Steady	Focus point	Wide	
	Hurdles (page 30)				Normal		
	Sprints and hurdles (remote-control shots of multiple runners approaching the camera, page 30)	Group-area AF (C1): 15 × 3	5	Steady	—	—	
	Marathons (from a vehicle, page 30)	9-point dynamic-area AF			Focus point	Normal	
	Shot put, discus, and hammer throw (from the front, at a distance, page 31)	Group-area AF	3	Erratic	—	—	
	Javelin (from the front, at a distance, page 31)	Group-area AF (C1): 7 × 7					
	Long jump and triple jump (facing oncoming jumpers, page 31)	Auto-area AF	3	Erratic	—	—	
	High jump (page 32)	Group-area AF (C1): 3 × 5					
	Pole vault (page 32)	Auto-area AF					
	Aquatics	Swimming (page 33)	9-point dynamic-area AF	2	Steady		Normal
Diving (page 34)		3D-tracking	3			—	
Artistic swimming (page 34)		9-point dynamic-area AF				Normal	
Table tennis (page 35)	Group-area AF (C1): 3 × 7	4			—		
BMX and skateboarding (page 35)	Auto-area AF	3		Focus point	—	Enable	

Custom Settings: a3 **[Focus tracking with lock-on]** (page 11); a5 **[Store points by orientation]** (page 12); a7 **[Single-point AF watch area]** (page 14); a12 **[Auto-area AF starting point]** (page 14)

Soccer

Photographing soccer matches involves quick changes of focus and subjects that may be briefly obscured by foreground objects. The following autofocus settings are recommended:



Autofocus mode	AF-C	
AF-area mode	9-point dynamic-area AF	
Custom Settings		
a1 AF-C priority selection	[Release]	
a3 Focus tracking with lock-on	Blocked shot AF response	[2]
	Subject motion	[Steady]
a5 Store points by orientation	[Focus point]	
a7 Single-point AF watch area	[Normal]	

Nine-point dynamic-area AF is recommended if you want to focus on a single athlete in a group of players. Note that the option selected for Custom Setting a7 [Single-point AF watch area] also applies during dynamic-area AF: if you choose [Wide], the camera will use data from surrounding areas to locate subjects slightly outside the selected focus point, making it easier to focus on fast-moving subjects (page 14).

Gymnastics

This section lists some suggested settings for gymnastics events.

■ Floor Exercises and Rhythmic Gymnastics

Auto-area AF is recommended if composition is a priority, but 49-point dynamic-area AF may be preferred if the background contains objects with regular, detailed patterns, as otherwise photos may not be in focus even if the in-focus indicator (●) is lit. To capture fast-moving subjects, choose group-area AF or a dynamic-area AF option with a comparatively high number of focus points.

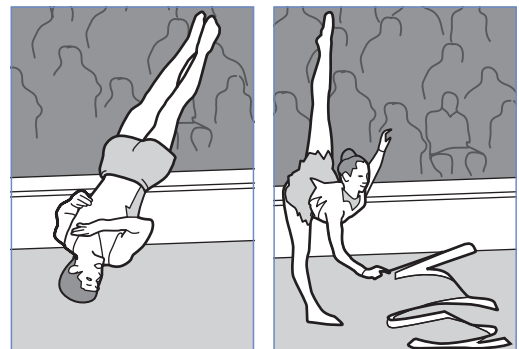

Autofocus mode	AF-C	
AF-area mode	Auto-area AF	
Custom Settings		
a1 AF-C priority selection	[Release]	
a3 Focus tracking with lock-on	Blocked shot AF response	[3]
	Subject motion	[Steady]
a11 Auto-area AF face detection	[On]	

Select [Focus point and AF-area mode] for Custom Setting a5 [Store points by orientation] to automatically switch focus points and AF-area modes as you rotate the camera (page 12). Choose [15 points] for Custom Setting a4 [Focus points used] to reduce the number of focus points for quicker selection (page 11).

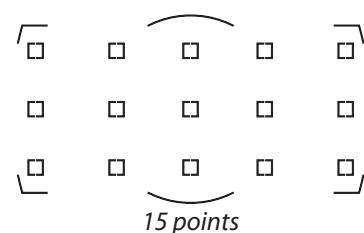
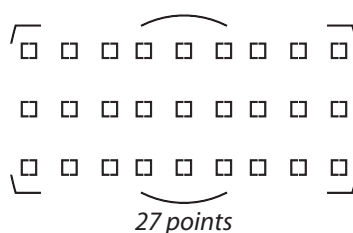
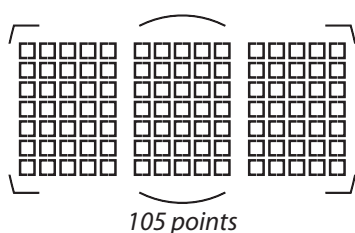

■ Balance Beam

To automatically switch focus points and AF-area modes as you rotate the camera from “wide” to “tall” orientation, select **[Focus point and AF-area mode]** for Custom Setting a5 **[Store points by orientation]** (page 12). Choosing group-area AF (C1) with a 15 × 3 focus-point group for wide-orientation shots and group-area AF (C2) with a 7 × 7 group for tall-orientation shots will help deliver accurate focus in all orientations.

Autofocus mode	AF-C	
AF-area mode	<ul style="list-style-type: none"> • Wide: Group-area AF (C1), 15 × 3 • Tall: Group-area AF (C2), 7 × 7 	
Custom Settings		
a1 AF-C priority selection		[Release]
a3 Focus tracking with lock-on	Blocked shot AF response	[3]
	Subject motion	[Steady]
a5 Store points by orientation		[Focus point and AF-area mode]
a9 Group-area AF face detection		[On]

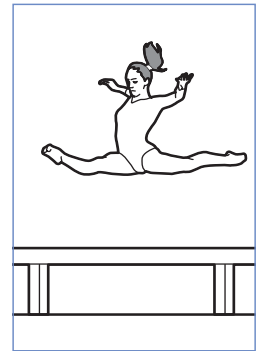

■ Vault

If you find the subject hard to frame, selecting auto-area AF will allow you concentrate on composition while leaving the camera in charge of choosing the focus point. If you find that auto-area AF tends to focus on the vault, select **[Enable]** for Custom Setting a12 **[Auto-area AF starting point]** and choose a focus point before shooting (page 14).

Autofocus mode	AF-C	
AF-area mode	Auto-area AF	
Custom Settings		
a1 AF-C priority selection		[Release]
a3 Focus tracking with lock-on	Blocked shot AF response	[3]
	Subject motion	[Erratic]
a11 Auto-area AF face detection		[On]
a12 Auto-area AF starting point		[Enable]

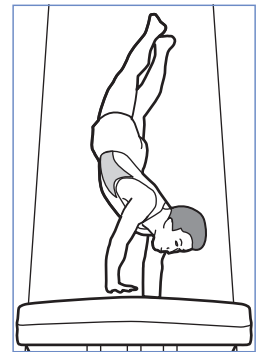

If the camera is slow to refocus on the gymnast after focusing on the vault, choose a lower value for Custom Setting a3 **[Focus tracking with lock-on]** > **[Blocked shot AF response]**.

■ Rings and Horizontal and Uneven Bars

3D-tracking is recommended for subjects that change posture and position frequently and often are near apparatus such as bars or rings.

Autofocus mode	AF-C	
AF-area mode	3D-tracking	
Custom Settings		
a1 AF-C priority selection		[Release]
a3 Focus tracking with lock-on	Blocked shot AF response	[3]
	Subject motion	[Erratic]
a8 3D-tracking face-detection		[On]

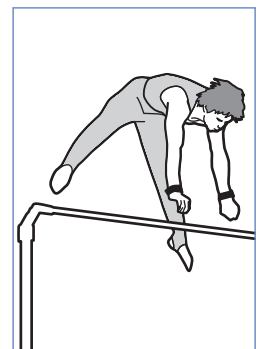

Athletics

You may find these settings useful when photographing road-running or track-and-field events.

■ Sprints (Hand-Held, Single Runner, from the Front)

Choose *9-point dynamic-area AF* when photographing approaching sprinters to help prevent the camera focusing on their hands, or *custom group-area AF* (C1 or C2) with a wide custom focus group (for example, 15 × 3) to focus on the closest subject when runners are lined up across the frame. Dynamic-area AF is recommended if the background features complex repeating patterns, as otherwise the in-focus indicator (●) may be displayed when the subject is not in focus.



Autofocus mode		AF-C
AF-area mode		9-point dynamic-area AF
Custom Settings		
a1 AF-C priority selection		[Release]
a3 Focus tracking with lock-on	Blocked shot AF response	[3]
	Subject motion	[Steady]
a5 Store points by orientation		[Focus point]
a7 Single-point AF watch area		[Wide]

When photographing runners after they have crossed the finish line, select [Focus point and AF-area mode] for Custom Setting a5 [Store points by orientation] to automatically switch focus points and AF-area modes as you rotate the camera between “tall” (portrait) orientations and “wide” (landscape) orientation ([page 12](#)).

🔧 Instant AF-Area Mode Selection

For flexible AF-area mode selection when photographing approaching runners, select 9-point dynamic-area AF with the camera and assign [Group-area AF (C1)] to the focus function buttons using Custom Setting f3 [Custom controls] > [Fn Lens focus function buttons] > [AF-area mode] ([page 19](#)). You can then press a focus function button to select the custom group-area AF option when your subject is far away and release the button to instantly switch to 9-point dynamic-area AF as the runners approach, all without taking your eye from the viewfinder.

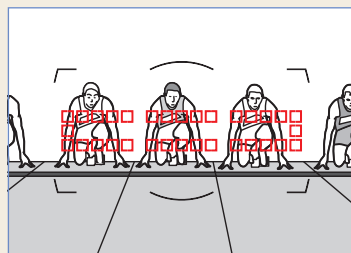
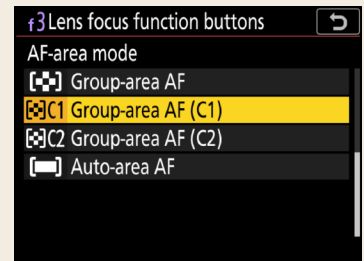

Group-area AF (C1)
(distant subject)



9-point dynamic-area AF
(runner approaching)

AF-area mode can also be assigned to the **Pv**, **Fn1**, **Fn2**, or **AF-ON** button, to the center of the sub-selector, or to the **AF-ON** button for vertical shooting ([page 18](#)).

■ Hurdles

The settings below let you refocus as needed if the camera focuses on the hurdles in the foreground while the race is being run. When photographing hurdlers who have crossed the finish line, select **[Focus point and AF-area mode]** for Custom Setting a5 **[Store points by orientation]** to automatically switch focus points and AF-area modes as you rotate the camera between “tall” (portrait) orientations and “wide” (landscape) orientation ([page 12](#)).

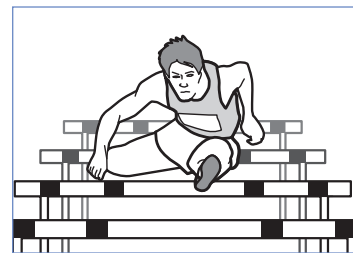

Autofocus mode	AF-C	
AF-area mode	9-point dynamic-area AF	
Custom Settings		
a1 AF-C priority selection	[Release]	
a3 Focus tracking with lock-on	Blocked shot AF response	[3]
	Subject motion	[Steady]
a5 Store points by orientation	[Focus point]	
a7 Single-point AF watch area	[Normal]	

■ Sprints and Hurdles: Remote Photography

Choose custom group-area AF (C1 or C2) with a wide custom focus group (for example, 15 × 3) to focus on the closest subject when runners are lined up across the frame.

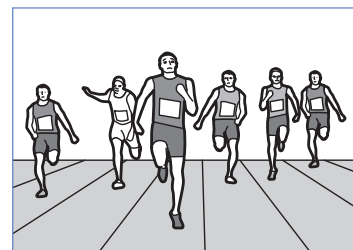

Be sure the selected group does not contain hurdles or other obstructions.

Autofocus mode	AF-C	
AF-area mode	Group-area AF (C1), 15 × 3	
Custom Settings		
a1 AF-C priority selection	[Release]	
a3 Focus tracking with lock-on	Blocked shot AF response	[3]
	Subject motion	[Steady]
a9 Group-area AF face detection	[On]	

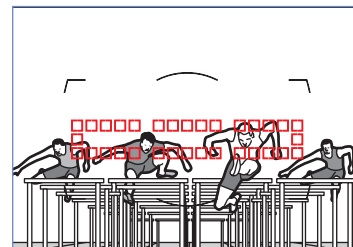

■ Marathons (from a Vehicle)

When shooting from a moving vehicle, choose 9-point dynamic-area AF to keep specific runners in focus as they change position in the pack, auto-area AF if you find it hard to keep your subject in the focus point. If your lens supports **SPORT** or **ACTIVE** vibration reduction, these options can be used to reduce camera blur.

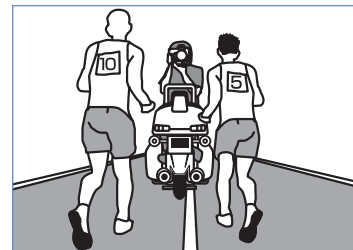

Autofocus mode	AF-C	
AF-area mode	9-point dynamic-area AF	
Custom Settings		
a1 AF-C priority selection	[Release]	
a3 Focus tracking with lock-on	Blocked shot AF response	[3]
	Subject motion	[Steady]
a5 Store points by orientation	[Focus point]	
a7 Single-point AF watch area	[Normal]	

■ **Shot Put, Discus, and Hammer Throw (from the Front, at a Distance)**

Choose group-area AF for more reliable focus when photographing these events from the front at long ranges.

Autofocus mode		AF-C
AF-area mode		Group-area AF
Custom Settings		
a1 AF-C priority selection		[Release]
a3 Focus tracking with lock-on	Blocked shot AF response	[5]
	Subject motion	[Steady]
a9 Group-area AF face detection		[On]

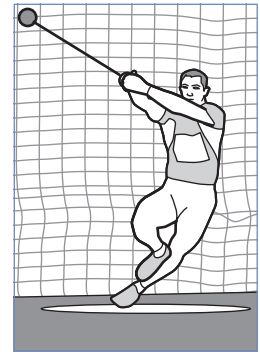

■ **Javelin (from the Front, at a Distance)**

For long shots of javelin competitions, choose custom group-area AF (C1 or C2) and select a focus group just big enough to cover the athlete's upper body. This helps the camera focus on faces instead of hands or foreground objects.

Autofocus mode		AF-C
AF-area mode		Group-area AF (C1), 7 × 7
Custom Settings		
a1 AF-C priority selection		[Release]
a3 Focus tracking with lock-on	Blocked shot AF response	[3]
	Subject motion	[Erratic]
a9 Group-area AF face detection		[On]

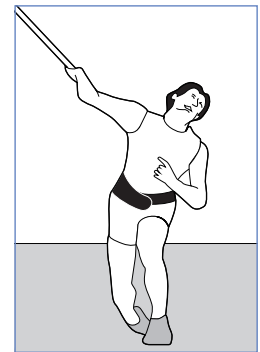

■ **Long Jump and Triple Jump (Facing Oncoming Jumpers)**

Auto-area AF is recommended for subjects that rapidly change posture and position. Selecting [On] for Custom Setting a11 [Auto-area AF face detection] helps the camera focus on the athlete's face, while selecting [Erratic] for Custom Setting a3 [Focus tracking with lock-on] > [Subject motion] helps the camera focus when the subject slows abruptly.

Autofocus mode		AF-C
AF-area mode		Auto-area AF
Custom Settings		
a1 AF-C priority selection		[Release]
a3 Focus tracking with lock-on	Blocked shot AF response	[3]
	Subject motion	[Erratic]
a11 Auto-area AF face detection		[On]

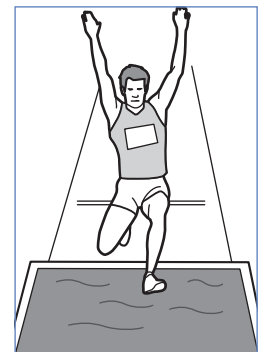

■ High Jump

To help the camera focus on faces of subjects that are undergoing rapid changes of posture and position, choose custom group-area AF (C1 or C2) and select a focus group just big enough to cover the athlete's upper body.

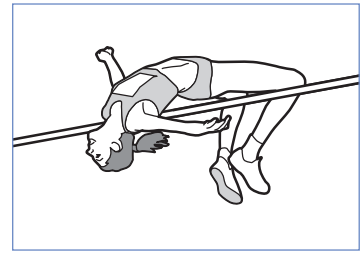

Autofocus mode	AF-C
AF-area mode	Group-area AF (C1), 3 × 5
Custom Settings	
a1 AF-C priority selection	[Release]
a3 Focus tracking with lock-on	Blocked shot AF response [3] Subject motion [Erratic]
a9 Group-area AF face detection	[On]

■ Pole Vault

Auto-area AF is recommended for subjects that rapidly change posture and position. Selecting [On] for Custom Setting a11 [Auto-area AF face detection] helps the camera focus on the athlete's face rather than on the pole or mat, while selecting [Erratic] for Custom Setting a3 [Focus tracking with lock-on] > [Subject motion] helps the camera focus when the subject slows abruptly.

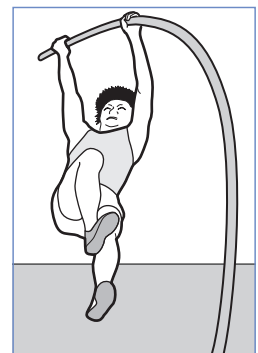

Autofocus mode	AF-C
AF-area mode	Auto-area AF
Custom Settings	
a1 AF-C priority selection	[Release]
a3 Focus tracking with lock-on	Blocked shot AF response [3] Subject motion [Erratic]
a11 Auto-area AF face detection	[On]

Aquatics

Here are some settings you may find helpful when photographing aquatic events.

■ Swimming

Choosing 9-point dynamic-area AF helps prevent the camera focusing on splashes while letting you instantly refocus on the main subject as needed. To quickly switch focus from one swimmer to another, choose lower values for Custom Setting a3 [Focus tracking with lock-on] > [Blocked shot AF response].

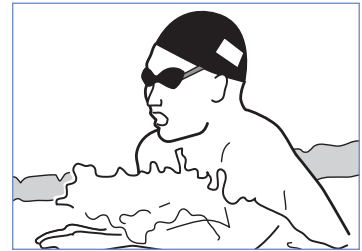

Autofocus mode		AF-C
AF-area mode		9-point dynamic-area AF
Custom Settings		
a1 AF-C priority selection		[Release]
a3 Focus tracking with lock-on	Blocked shot AF response	[2]
	Subject motion	[Steady]
a7 Single-point AF watch area		[Normal]

⚡ Instant AF-Area Mode Selection

For flexible AF-area mode selection when photographing the start of a race, select 9-point dynamic-area AF with the camera and assign [Group-area AF] to the focus function buttons using Custom Setting f3 [Custom control] > [Fn Lens focus function buttons] > [AF-area mode] (page 19). You can then press a focus function button to select group-area AF when your subject is diving from the starting block and release the button to instantly switch to 9-point dynamic-area AF once the swimmer is in the water, all without taking your eye from the viewfinder.

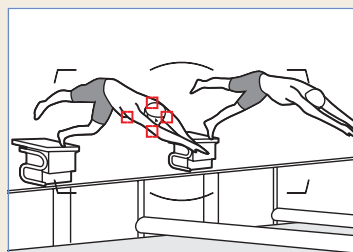
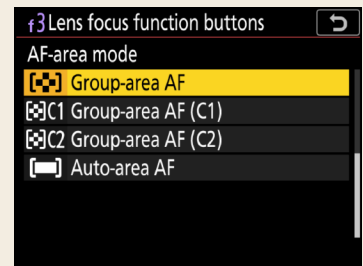

Group-area AF
(distant subject diving)



9-point dynamic-area AF
(subject swimming)

AF-area mode can also be assigned to the **Pv**, **Fn1**, **Fn2**, or **AF-ON** button, to the center of the sub-selector, or to the **AF-ON** button for vertical shooting (page 18).

■ Diving

When photographing divers against *low-contrast, undifferentiated backgrounds*, choose 3D-tracking, position the focus area over your subject (for best results, choose the uniform or another area of the subject that is a different color from the background), and press and hold the **AF-ON** button or keep the shutter-release button pressed halfway. The camera will automatically track the diver, letting you concentrate on composition.

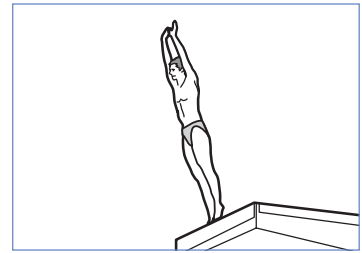

Autofocus mode	AF-C	
AF-area mode	3D-tracking	
Custom Settings		
a1 AF-C priority selection	[Release]	
a3 Focus tracking with lock-on	Blocked shot AF response	[3]
	Subject motion	[Steady]
a8 3D-tracking face-detection	[On]	

When photographing divers against the stands, billboards, and other *high-contrast backgrounds*, select 105-point dynamic-area AF.

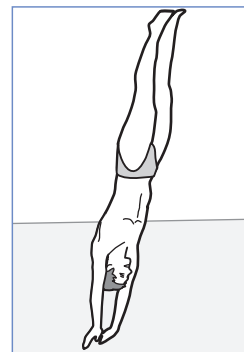

Low-contrast background

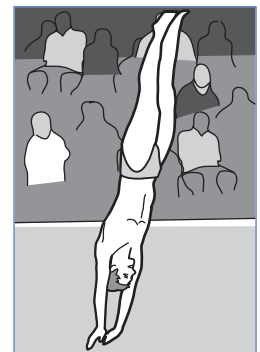

High-contrast background

■ Artistic Swimming

For events such as artistic swimming (also known as synchronized swimming), where your subjects change pose with dizzying speed and focus constantly switches from one subject to another, we recommend the ever-adaptable 9-point dynamic-area AF.

Autofocus mode	AF-C	
AF-area mode	9-point dynamic-area AF	
Custom Settings		
a1 AF-C priority selection	[Release]	
a3 Focus tracking with lock-on	Blocked shot AF response	[3]
	Subject motion	[Steady]
a7 Single-point AF watch area	[Normal]	

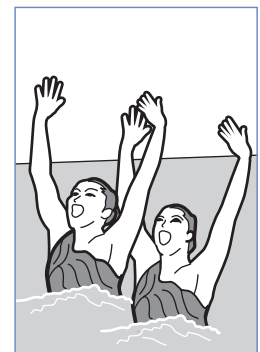
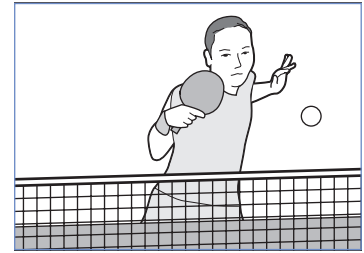

Table Tennis

Using custom group-area AF (C1 or C2) helps you frame shots with the net in the foreground.

Autofocus mode		AF-C
AF-area mode		Group-area AF (C1), 3 × 7
Custom Settings		
a1 AF-C priority selection		[Release]
a3 Focus tracking with lock-on	Blocked shot AF response	[4]
	Subject motion	[Steady]
a9 Group-area AF face detection		[On]



BMX and Skateboarding

If you find the subject hard to frame, selecting auto-area AF will allow you concentrate on composition while leaving the camera in charge of choosing the focus point. If you find that auto-area AF tends to focus on ramps or other foreground objects, select [Enable] for Custom Setting a12 [Auto-area AF starting point] and choose a focus point before shooting ([page 14](#)).

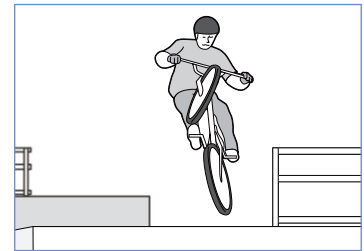

Autofocus mode		AF-C
AF-area mode		Auto-area AF
Custom Settings		
a1 AF-C priority selection		[Release]
a3 Focus tracking with lock-on	Blocked shot AF response	[3]
	Subject motion	[Steady]
a5 Store points by orientation		[Focus point]
a11 Auto-area AF face detection		[On]
a12 Auto-area AF starting point		[Enable]

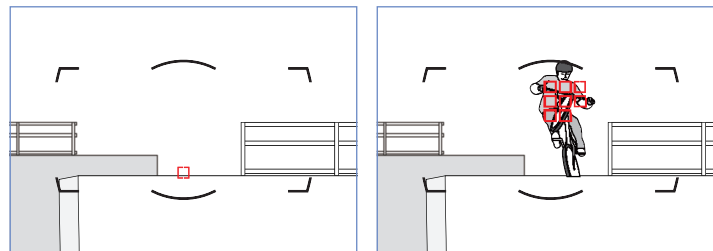

Nikon